

Stateflow[®]

User's Guide

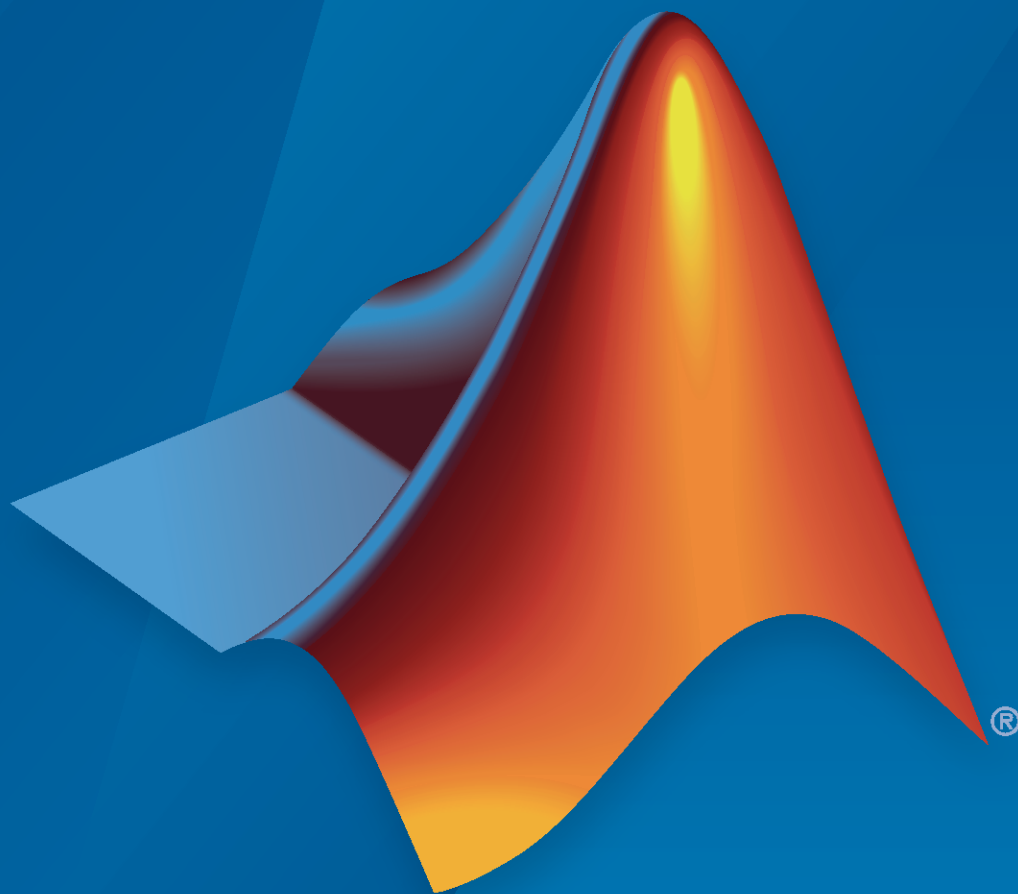

MATLAB[®]&SIMULINK[®]

R2020a



How to Contact MathWorks



Latest news: www.mathworks.com
Sales and services: www.mathworks.com/sales_and_services
User community: www.mathworks.com/matlabcentral
Technical support: www.mathworks.com/support/contact_us



Phone: 508-647-7000



The MathWorks, Inc.
1 Apple Hill Drive
Natick, MA 01760-2098

Stateflow® User's Guide

© COPYRIGHT 1997–2020 by The MathWorks, Inc.

The software described in this document is furnished under a license agreement. The software may be used or copied only under the terms of the license agreement. No part of this manual may be photocopied or reproduced in any form without prior written consent from The MathWorks, Inc.

FEDERAL ACQUISITION: This provision applies to all acquisitions of the Program and Documentation by, for, or through the federal government of the United States. By accepting delivery of the Program or Documentation, the government hereby agrees that this software or documentation qualifies as commercial computer software or commercial computer software documentation as such terms are used or defined in FAR 12.212, DFARS Part 227.72, and DFARS 252.227-7014. Accordingly, the terms and conditions of this Agreement and only those rights specified in this Agreement, shall pertain to and govern the use, modification, reproduction, release, performance, display, and disclosure of the Program and Documentation by the federal government (or other entity acquiring for or through the federal government) and shall supersede any conflicting contractual terms or conditions. If this License fails to meet the government's needs or is inconsistent in any respect with federal procurement law, the government agrees to return the Program and Documentation, unused, to The MathWorks, Inc.

Trademarks

MATLAB and Simulink are registered trademarks of The MathWorks, Inc. See www.mathworks.com/trademarks for a list of additional trademarks. Other product or brand names may be trademarks or registered trademarks of their respective holders.

Patents

MathWorks products are protected by one or more U.S. patents. Please see www.mathworks.com/patents for more information.

Revision History

May 1997	First printing	New
January 1999	Second printing	Revised for Version 2.0 (Release 11)
September 2000	Third printing	Revised for Version 4.0 (Release 12))
June 2001	Fourth printing	Revised for Version 4.1 (Release 12.1)
July 2002	Fifth printing	Revised for Version 5.0 (Release 13)
January 2003	Online only	Revised for Version 5.1 (Release 13SP1)
June 2004	Online only	Revised for Version 6.0 (Release 14)
October 2004	Online only	Revised for Version 6.1 (Release 14SP1)
March 2005	Online only	Revised for Version 6.21 (Release 14SP2)
September 2005	Online only	Revised for Version 6.3 (Release 14SP3)
March 2006	Online only	Revised for Version 6.4 (Release 2006a)
September 2006	Online only	Revised for Version 6.5 (Release 2006b)
March 2007	Online only	Revised for Version 6.6 (Release 2007a)
September 2007	Online only	Revised for Version 7.0 (Release 2007b)
March 2008	Online only	Revised for Version 7.1 (Release 2008a)
October 2008	Online only	Revised for Version 7.2 (Release 2008b)
March 2009	Online only	Revised for Version 7.3 (Release 2009a)
September 2009	Online only	Revised for Version 7.4 (Release 2009b)
March 2010	Online only	Revised for Version 7.5 (Release 2010a)
September 2010	Online only	Revised for Version 7.6 (Release 2010b)
April 2011	Online only	Revised for Version 7.7 (Release 2011a)
September 2011	Online only	Revised for Version 7.8 (Release 2011b)
March 2012	Online only	Revised for Version 7.9 (Release 2012a)
September 2012	Online only	Revised for Version 8.0 (Release 2012b)
March 2013	Online only	Revised for Version 8.1 (Release 2013a)
September 2013	Online only	Revised for Version 8.2 (Release 2013b)
March 2014	Online only	Revised for Version 8.3 (Release 2014a)
October 2014	Online only	Revised for Version 8.4 (Release 2014b)
March 2015	Online only	Revised for Version 8.5 (Release 2015a)
September 2015	Online only	Revised for Version 8.6 (Release 2015b)
October 2015	Online only	Rereleased for Version 8.5.1 (Release 2015aSP1)
March 2016	Online only	Revised for Version 8.7 (Release 2016a)
September 2016	Online only	Revised for Version 8.8 (Release 2016b)
March 2017	Online only	Revised for Version 8.9 (Release 2017a)
September 2017	Online only	Revised for Version 9.0 (Release 2017b)
March 2018	Online only	Revised for Version 9.1 (Release 2018a)
September 2018	Online only	Revised for Version 9.2 (Release 2018b)
March 2019	Online only	Revised for Version 10.0 (Release 2019a)
September 2019	Online only	Revised for Version 10.1 (Release 2019b)
March 2020	Online only	Revised for Version 10.2 (Release 2020a)

Stateflow Chart Concepts

Finite State Machine Concepts	1-2
Finite State Machine Representations	1-2
Stateflow Chart Representations	1-2
Notation	1-2
Semantics	1-3
Bibliography	1-3
The Stateflow Chart	1-4
How the Stateflow Chart Works with the Simulink Model	1-7
A Look at the Physical Plant	1-8
Running the Model	1-10
Implementing the Interface with Simulink	1-12
Build It Yourself or Use the Supplied Model	1-12
Design Considerations for Defining the Interface	1-12
Adding a Stateflow Block to a Simulink Model	1-13
Defining the Inputs and Outputs	1-16
Connecting the Stateflow Block to the Simulink Subsystem	1-21
Implementing the States to Represent Operating Modes	1-23
Build It Yourself or Use the Supplied Model	1-23
Design Considerations for Defining the States	1-23
Adding the Power On and Power Off States	1-26
Adding and Configuring Parallel States	1-27
Adding the On and Off States for the Fans	1-32
Adding the Transitions	1-33
Build It Yourself or Use the Supplied Model	1-33
Design Considerations for Defining Transitions Between States	1-33
Drawing the Transitions Between States	1-34
Adding Default Transitions	1-37
Adding Conditions to Guard Transitions	1-39
Adding Events to Guard Transitions	1-40
Implementing the Triggers	1-44
Build It Yourself or Use the Supplied Model	1-44
Design Considerations for Triggering Stateflow Charts	1-44
Defining the CLOCK Event	1-45
Connecting the Edge-Triggerred Events to the Input Signals	1-45

Setting Simulation Parameters and Breakpoints	1-47
Prepare the Chart Yourself or Use the Supplied Model	1-47
Checking That Your Chart Conforms to Best Practices	1-47
Setting the Length of the Simulation	1-48
Configuring Animation for the Chart	1-49
Setting Breakpoints to Observe Chart Behavior	1-49
Simulating the Air Controller Chart	1-49
Debugging Common Modeling Errors	1-54
Debugging State Inconsistencies	1-54
Debugging Data Range Violations	1-56

Stateflow Chart Notation

2

Overview of Stateflow Objects	2-2
Hierarchy of Stateflow Objects	2-2
Graphical Objects	2-2
Nongraphical Objects	2-3
Rules for Naming Stateflow Objects	2-5
Restriction on Name Length	2-5
Keywords to Avoid When Naming Stateflow Objects	2-5
States	2-8
State Hierarchy	2-8
State Decomposition	2-9
State Labels	2-10
State Hierarchy	2-14
State Hierarchy Example	2-14
Objects That a State Can Contain	2-14
State Decomposition	2-16
Exclusive (OR) State Decomposition	2-16
Parallel (AND) State Decomposition	2-16
Transitions	2-18
Transition Hierarchy	2-18
Transition Label Notation	2-19
Valid Transitions	2-20
Transition Connections	2-21
Self-Loop Transitions	2-24
Inner Transitions	2-25
Before Using an Inner Transition	2-25
After Using an Inner Transition to a Connective Junction	2-25
Using an Inner Transition to a History Junction	2-26
Default Transitions	2-28
Drawing Default Transitions	2-28

Label Default Transitions	2-28
Default Transition Examples	2-28
Combine Transitions and Junctions to Create Branching Paths	2-31
Add a Connective Junction	2-31
Modify Connective Junction Properties	2-31
Examples of Transition Paths with Connective Junctions	2-32
History Junctions	2-36
Example of History Junctions	2-36
History Junctions and Inner Transitions	2-36
Reusable Functions in Charts	2-37

Stateflow Semantics

3

Stateflow Semantics	3-2
Stateflow Objects	3-2
Graphical Objects	3-2
Nongraphical Objects	3-3
How Stateflow Objects Interact During Execution	3-5
Overview of the Example Model	3-5
Model of the Check-In Process for a Hotel	3-5
How the Chart Interacts with Simulink Blocks	3-7
Phases of Chart Execution	3-8
Modeling Guidelines for Stateflow Charts	3-19
Use signals of the same data type for input events	3-19
Use a default transition to mark the first state to become active among exclusive (OR) states	3-19
Use condition actions instead of transition actions whenever possible ...	3-19
Use explicit ordering to control the testing order of a group of outgoing transitions	3-19
Verify intended backtracking behavior in flow charts	3-19
Use a superstate to enclose substates that share the same state actions	3-19
Use MATLAB functions for performing numerical computations in a chart	3-20
Use descriptive names in function signatures	3-20
Use history junctions to record state history	3-20
Do not use history junctions in states with parallel (AND) decomposition	3-20
Use explicit ordering to control the execution order of parallel (AND) states	3-20
Types of Chart Execution	3-21
Life Cycle of a Stateflow Chart	3-21
Execution of an Inactive Chart	3-21
Execution of an Active Chart	3-21
Execution of a Chart at Initialization	3-21

Execution of a Stateflow Chart	3-23
Workflow for Stateflow Chart Execution	3-23
During Actions	3-24
Outgoing Transition	3-25
Inner Transitions	3-25
Chart Execution with a Valid Transition	3-25
Chart Execution Without a Valid Transition	3-26
Enter a Chart or State	3-28
Workflow for Entering a Chart or State	3-28
Chart Entry	3-30
State Entry	3-30
Entry Actions	3-30
Enter a Stateflow Chart	3-30
Entering a State by Using History Junctions	3-31
Entering a State by Using Supertransitions	3-32
Exit a State	3-34
Workflow for Exiting a State	3-34
Exit Actions	3-34
Exit a State Example	3-35
Exit a State by Using Supertransitions	3-35
Evaluate Transitions	3-37
Workflow for Evaluating Transitions	3-38
Transition Evaluation Order	3-38
Outgoing Transition Example	3-39
Outgoing Transition Example with Backtracking	3-40
Condition and Transition Actions	3-43
Super Step Semantics	3-45
Maximum Number of Iterations	3-45
Enable Super Step Semantics	3-45
Super Step Example	3-47
How Super Step Semantics Works with Multiple Input Events	3-48
Detection of Infinite Loops in Transition Cycles	3-50
Use Events to Execute Charts	3-51
How Stateflow Charts Respond to Events	3-51
Events in Simulink Models	3-51
Events in Standalone Charts	3-53
Group and Execute Transitions	3-56
Transition Flow Chart Types	3-56
Order of Execution for a Set of Flow Charts	3-56
Execution Order for Parallel States	3-58
Ordering for Parallel States	3-58
Explicit Ordering of Parallel States	3-58
Implicit Ordering of Parallel States	3-59
Order Maintenance for Parallel States	3-60
Execution Priorities in Restored States	3-61
Switching Between Explicit and Implicit Ordering	3-62
Execution Order of Parallel States in Boxes and Subcharts	3-62

4

Model Reactive Systems in Stateflow	4-2
Identify System Attributes	4-2
Select a State Machine Type	4-2
Specify State Actions and Transition Conditions	4-2
Define Persistent Data to Store State Variables	4-3
Simplify State Actions and Transition Conditions with Function Calls	4-3
Check That Your System Representation Is Complete	4-3
Represent Operating Modes by Using States	4-5
Create a State	4-5
Move and Resize States	4-5
Create Substates and Superstates	4-5
Group States	4-6
Specify Substate Decomposition	4-7
Specify Activation Order for Parallel States	4-7
Change State Properties	4-8
Label States	4-11
Transition Between Operating Modes	4-14
Create a Transition	4-14
Label Transitions	4-14
Move Transitions	4-15
Change Transition Arrowhead Size	4-16
Create Self-Loop Transitions	4-17
Create Default Transitions	4-17
Change Transition Properties	4-17
Stateflow Editor Operations	4-20
Stateflow Editor	4-20
Undo and Redo Editor Operations	4-23
Specify Colors and Fonts in a Chart	4-24
Content Preview for Stateflow Objects	4-27
Intelligent Tab Completion for Stateflow Charts	4-28
Differentiate Elements of Action Language Syntax	4-29
Select and Deselect Graphical Objects	4-30
Cut and Paste Graphical Objects	4-30
Copy Graphical Objects	4-30
Comment Out Objects	4-31
Format Chart Objects	4-31
Generate a Model Report	4-40

5

Model Logic Patterns and Iterative Loops Using Flow Charts

Flow Charts in Stateflow	5-2
Draw a Flow Chart	5-2
Best Practices for Creating Flow Charts	5-2

Create Flow Charts by Using Pattern Wizard	5-5
Create Reusable Flow Charts	5-5
Insert Logic Patterns in Existing Flow Charts	5-6
Save Custom Flow Chart Patterns	5-9
Reuse Custom Flow Chart Patterns	5-9
MAB-Compliant Patterns from the Pattern Wizard	5-11
Convert MATLAB Code into Stateflow Flow Charts	5-18
Create Flow Charts from MATLAB Scripts	5-18

Simulink Subsystems as Stateflow States

6

Simulink Subsystems as States	6-2
When to Use Simulink Based States	6-2
Model a Pole Vaultler by Using Simulink Based States	6-2
Limitations	6-9
Create and Edit Simulink Based States	6-11
Create a Simulink Based State	6-11
Create Inports and Outports	6-14
Access Block State Data	6-17
Textual Access	6-18
Graphical Access	6-20
Map Variables for Simulink Based States	6-23
Map Variables in a Simulink Based State	6-23
Set Simulink Based State Properties	6-25

Build Mealy and Moore Charts

7

Overview of Mealy and Moore Machines	7-2
Semantics of Mealy and Moore Machines	7-2
Create Mealy and Moore Charts	7-3
Advantages of Mealy and Moore Charts	7-3
Design Considerations for Mealy Charts	7-5
Mealy Semantics	7-5
Design Rules for Mealy Charts	7-5
Model a Vending Machine by Using Mealy Semantics	7-7
Design Considerations for Moore Charts	7-9
Moore Semantics	7-9
Design Rules for Moore Charts	7-9

Model a Traffic Light by Using Moore Semantics	7-12
Convert Charts Between Mealy and Moore Semantics	7-14
Transform Chart from Mealy to Moore Semantics	7-14
Transform Chart from Moore to Mealy Semantics	7-16
Initialize Persistent Variables in MATLAB Functions	7-18
MATLAB Function Block With No Direct Feedthrough	7-18
State Control Block in Synchronous Mode	7-20
Stateflow Chart Implementing Moore Semantics	7-21

Techniques for Streamlining Chart Design

8

Record State Activity by Using History Junctions	8-2
Create a History Junction	8-2
Change History Junction Size	8-2
Change History Junction Properties	8-2
Encapsulate Modal Logic by Using Subcharts	8-4
Create a Subchart	8-4
Rules of Subchart Conversion	8-4
Convert a State to a Subchart	8-4
Manipulate Subcharts as Objects	8-5
Open a Subchart	8-5
Edit a Subchart	8-6
Navigate Subcharts	8-6
Move Between Levels of Hierarchy by Using Supertransitions	8-7
Draw a Supertransition Into a Subchart	8-8
Draw a Supertransition Out of a Subchart	8-10
Label Supertransitions	8-11
Reuse Logic Patterns by Defining Graphical Functions	8-13
Define a Graphical Function	8-13
Declare Function Arguments and Return Values	8-14
Call Graphical Functions in States and Transitions	8-15
Specify Graphical Function Properties	8-15
Manage Large Graphical Functions	8-16
Event Broadcasts in Graphical Functions	8-16
Export Stateflow Functions for Reuse	8-17
How to Export Chart-Level Functions	8-17
Rules for Exporting Chart-Level Functions	8-17
Export Chart-Level Functions	8-18
Group Chart Objects by Using Boxes	8-22
Semantics of Stateflow Boxes	8-22
Rules for Using Boxes	8-22
Draw and Edit a Box	8-23
Examples of Using Boxes	8-25

Reuse Functions by Using Atomic Boxes	8-28
Example of an Atomic Box	8-28
Benefits of Using Atomic Boxes	8-29
Create an Atomic Box	8-29
When to Use Atomic Boxes	8-31
Add Descriptive Comments in a Chart	8-32
Change Annotation Properties	8-32
Include TeX Formatting Instructions	8-33

Define Data

9

Add Stateflow Data	9-2
Add Data Through the Symbols Pane	9-2
Add Data by Using the Stateflow Editor Menu	9-2
Add Data Through the Model Explorer	9-3
Best Practices for Using Data in Charts	9-3
Set Data Properties	9-5
Stateflow Data Properties	9-5
Fixed-Point Data Properties	9-9
Logging Properties	9-15
Additional Properties	9-15
Default Data Property Values	9-16
Specify Data Properties by Using MATLAB Expressions	9-16
Share Data with Simulink and the MATLAB Workspace	9-19
Share Input and Output Data with Simulink	9-19
Initialize Data from the MATLAB Base Workspace	9-19
Save Data to the MATLAB Base Workspace	9-20
Share Parameters with Simulink and the MATLAB Workspace	9-21
Initialize Parameters from the MATLAB Base Workspace	9-21
Share Simulink Parameters with Charts	9-21
Access Data Store Memory from a Chart	9-23
Local and Global Data Store Memory	9-23
Bind Stateflow Data to Data Stores	9-23
Store and Retrieve Global Data	9-24
Best Practices for Using Data Stores	9-24
Specify Type of Stateflow Data	9-27
Specify Data Type by Using the Data Type Assistant	9-27
Inherit Data Types from Simulink Objects	9-30
Derive Data Types from Other Data Objects	9-30
Specify Data Types by Using a Simulink Alias	9-31
Strong Data Typing with Simulink Inputs and Outputs	9-31
Specify Size of Stateflow Data	9-33
Inherit Data Size	9-33
Specify Data Size by Using Numeric Values	9-33

Specify Data Size by Using Expressions	9-34
Handle Integer Overflow for Chart Data	9-36
When Integer Overflow Can Occur	9-36
Support for Handling Integer Overflow in Charts	9-36
Effect of Integer Promotion Rules on Saturation	9-37
Impact of Saturation on Error Checks	9-38
Identify Data by Using Dot Notation	9-39
Resolution of Qualified Data Names	9-39
Best Practices for Using Dot Notation	9-40
Examples of Qualified Data Name Resolution	9-40
Resolve Data Properties from Simulink Signal Objects	9-43

Active State Data

10

Monitor State Activity Through Active State Data	10-2
Types of Active State Data	10-2
Enable Active State Data	10-2
Active State Data Properties	10-3
Set Scope for Active State Data	10-3
Define State Activity Enumeration Type	10-3
State Activity and Parallel States	10-4
Limitations for Active State Data	10-5
Simplify Stateflow Charts by Incorporating Active State Output	10-7
View State Activity by Using the Simulation Data Inspector	10-11
Log to the Simulation Data Inspector from Stateflow	10-11
Check State Activity by Using the in Operator	10-14
The in Operator	10-14
Resolution of State Activity	10-14
Best Practices for Checking State Activity	10-15
Examples of State Activity Resolution	10-16
Model An Intersection Of One-Way Streets	10-20

Define Events

11

Synchronize Model Components by Broadcasting Events	11-2
Types of Events	11-2
Define Events in a Chart	11-2
Access Event Information from a Stateflow Chart	11-3
Best Practices for Using Events in Stateflow Charts	11-4

Set Properties for an Event	11-5
Stateflow Event Properties	11-5
Activate a Stateflow Chart by Sending Input Events	11-7
Activate a Stateflow Chart by Using Edge Triggers	11-7
Activate a Stateflow Chart by Using Function Calls	11-8
Association of Input Events with Control Signals	11-9
Data Types Allowed for Input Events	11-9
Control States in Charts Enabled by Function-Call Input Events	11-11
Activate a Simulink Block by Sending Output Events	11-14
Activate a Simulink Block by Using Edge Triggers	11-14
Activate a Simulink Block by Using Function Calls	11-17
Approximate a Function Call by Using Edge-Triggered Events	11-19
Association of Output Events with Output Ports	11-22
Control Chart Behavior by Using Implicit Events	11-23
Implicit Events Based on Chart Execution	11-23
Implicit Events Based on Data and States	11-23
Count Events by Using the temporalCount Operator	11-26
Collect and Store Input Data in a Vector	11-26
Yo-Yo Control of Satellites	11-27

Messages

12

Communicate with Stateflow Charts by Sending Messages	12-2
Define Messages in a Chart	12-2
Lifetime of a Stateflow Message	12-3
Limitations for Messages	12-4
Set Properties for a Message	12-5
Stateflow Message Properties	12-5
Message Queue Properties	12-7
Control Message Activity in Stateflow Charts	12-9
Access Message Data	12-9
Send a Message	12-9
Guard Transitions and Actions	12-10
Receive a Message	12-11
Discard a Message	12-11
Forward a Message	12-12
Determine if a Message Is Valid	12-12
Determine the Length of the Queue	12-13
Use the Sequence Viewer Block to Visualize Messages, Events, and Entities	12-14
Components of the Sequence Viewer Window	12-15
Navigate the Lifeline Hierarchy	12-17

View State Activity and Transitions	12-19
View Function Calls	12-20
Simulation Time in the Sequence Viewer Window	12-21
Redisplay of Information in the Sequence Viewer Window	12-22
View Differences Between Stateflow Messages, Events, and Data	12-23
Model a Distributed Traffic Control System by Using Messages	12-29

Use Actions in Charts

13

State Action Types	13-2
entry Actions	13-3
exit Actions	13-4
during Actions	13-4
bind Actions	13-4
on Actions	13-5
Transition Action Types	13-7
Event or Message Triggers	13-7
Conditions	13-8
Condition Actions	13-8
Transition Actions	13-9
Eliminate Redundant Code by Combining State Actions	13-10
How to Combine State Actions	13-10
Order of Execution of Combined Actions	13-11
Rules for Combining State Actions	13-11
Supported Operations for Chart Data	13-13
Binary Operations	13-13
Unary Operations and Actions	13-15
Assignment Operations	13-15
Type Cast Operations	13-16
Bitwise Operations	13-17
Pointer and Address Operations	13-18
Replace Operations with Application Implementations	13-18
Supported Symbols in Actions	13-20
Boolean Symbols, true and false	13-20
Comment Symbols, %, //, /*	13-20
Hexadecimal Notation Symbols, 0xFF	13-21
Infinity Symbol, inf	13-21
Line Continuation Symbol,	13-21
Literal Code Symbol, \$	13-21
MATLAB Display Symbol, ;	13-21
Single-Precision Floating-Point Number Symbol, F	13-21
Time Symbol, t	13-21
Call C Library Functions in C Charts	13-23
Call C Library Functions	13-23

Call the abs Function	13-23
Call min and max Functions	13-24
Replacement of Math Library Functions with Application Implementations	13-24
Call Custom C Code Functions	13-24
Access MATLAB Functions and Workspace Data in C Charts	13-28
ml Namespace Operator	13-28
ml Function	13-29
ml Expressions	13-30
Which ml Should I Use?	13-30
ml Data Type	13-31
How Charts Infer the Return Size for ml Expressions	13-33
Broadcast Local Events to Synchronize Parallel States	13-37
Directed Event Broadcasting	13-37
Directed Local Event Broadcast Using send	13-37
Directed Local Event Broadcast Using Qualified Event Names	13-38
Diagnostic for Detecting Undirected Local Event Broadcasts	13-38
Control Chart Execution by Using Temporal Logic	13-40
Temporal Logic Operators	13-40
Examples of Temporal Logic	13-46
Notation for Event-Based Temporal Logic in Transitions	13-50
Best Practices for Temporal Logic	13-51
Detect Changes in Data Values	13-56
Change Detection Operators	13-56
Implementation of Change Detection	13-59
Control Function-Call Subsystems by Using bind Actions	13-63
Bind a Function-Call Subsystem to a State	13-63
Bind a Function-Call Subsystem to a State	13-66
Avoid Muxed Trigger Events with Binding	13-68
Control Oscillations by Using the duration Operator	13-70
Control Oscillation with Parallel State Logic	13-70
Control Oscillation with the duration Operator	13-71

MATLAB Syntax Support for States and Transitions

14

Modify the Action Language for a Chart	14-2
Change the Default Action Language	14-2
Auto Correction When Using MATLAB as the Action Language	14-2
C to MATLAB Syntax Conversion	14-2
Rules for Using MATLAB as the Action Language	14-3
Differences Between MATLAB and C as Action Language Syntax	14-5
Compare Functionality of Action Languages	14-5

Model an Assembly Line Feeder	14-9
Typical Approaches to Chart Programming	14-9
Design Requirements	14-9
Identify System Attributes	14-9
Build the Model Yourself or Use the Supplied Model	14-10
Add a Stateflow Chart to the Feeder Model	14-10
Add States to Represent Operating Modes	14-12
Implement State Actions	14-12
Specify Transition Conditions	14-14
Define Data for Your System	14-16
Verify the System Representation	14-19
Alternative Approach: Event-Based Chart	14-20
Feeder Chart Activated by Input Events	14-20

Tabular Expression of Modal Logic

15

State Transition Tables in Stateflow	15-2
Rules for Using State Transition Tables	15-4
Differences Between State Transition Tables and Charts	15-4
Anatomy of a State Transition Table	15-5
Create State Transition Table and Specify Properties	15-6
Generate Diagrams from State Transition Tables	15-7
State Transition Table Operations	15-8
Insert Rows and Columns	15-8
Move Rows and Cells	15-8
Copy Rows and Transition Cells	15-8
Set Default State	15-9
Add History Junction	15-9
Print State Transition Tables	15-9
Select and Clear Table Elements	15-9
Undo and Redo Edit Operations	15-9
Highlight Flow of Logic in a State Transition Table	15-10
State Transition Table Diagnostics	15-12
Model Bang-Bang Controller by Using a State Transition Table	15-13
Design Requirements	15-13
Identify System Attributes	15-13
Build the Controller or Use the Supplied Model	15-14
Create a New State Transition Table	15-14
Add States and Hierarchy	15-15
Specify State Actions	15-16
Specify Transition Conditions and Actions	15-18
Define Data	15-20
Connect the Transition Table and Run the Model	15-22
View the Graphical Representation	15-23
Debug Run-Time Errors in a State Transition Table	15-25
Create the Model and the State Transition Table	15-25

Debug the State Transition Table	15-26
Correct the Run-Time Error	15-26

Make States Reusable with Atomic Subcharts

16

Create Reusable Subcomponents by Using Atomic Subcharts	16-2
Example of an Atomic Subchart	16-2
Benefits of Using Atomic Subcharts	16-2
Create an Atomic Subchart	16-3
When to Use Atomic Subcharts	16-4
Rules for Using Atomic Subcharts	16-7
Chart Properties and Atomic Subcharts	16-7
Data in Atomic Subcharts	16-7
Events in Atomic Subcharts	16-8
Functions and Atomic Subcharts	16-9
Restrictions for Converting to Atomic Subcharts	16-9
Map Variables for Atomic Subcharts and Boxes	16-11
Map Input and Output Data for an Atomic Subchart	16-11
Map Atomic Subchart Variables to Bus Elements	16-15
Map Atomic Subchart Variables to the Elements of a Matrix	16-16
Map Atomic Subchart Parameters to Expressions	16-17
Map Input Events for an Atomic Subchart	16-20
Reuse a State Multiple Times in a Chart	16-23
Reduce the Compilation Time of a Chart	16-29
Divide a Chart into Separate Units	16-32
Generate Separate Code for an Atomic Subchart	16-35
Model a Redundant Sensor Pair by Using Atomic Subcharts	16-39
Model an Elevator System by Using Atomic Subcharts	16-43

Save and Restore Simulations with Operating Point

17

Using Operating Points in Stateflow	17-2
Division of a Long Simulation into Segments	17-2
Test of a Chart Response to Different Settings	17-2
Divide a Long Simulation into Segments	17-4
Goal of the Tutorial	17-4
Define the Operating Point	17-4
Load the Operating Point	17-5

Simulate the Specific Segment	17-6
Test a Unique Chart Configuration	17-8
Goal of the Tutorial	17-8
Define the Operating Point	17-9
Load the Operating Point and Modify Values	17-10
Test the Modified Operating Point	17-13
Test a Chart with Fault Detection and Redundant Logic	17-15
Goal of the Tutorial	17-15
Define the Operating Point	17-18
Modify Operating Point Values for One Actuator Failure	17-19
Test the Operating Point for One Failure	17-22
Modify Operating Point Values for Two Actuator Failures	17-24
Test the Operating Point for Two Failures	17-25
Methods for Interacting with the Operating Point of a Chart	17-27
Rules for Using the Operating Point of a Chart	17-30
Limitations on Values You Can Modify	17-30
Rules for Modifying Data Values	17-30
Rules for Modifying State Activity	17-30
Restriction on Continuous-Time Charts	17-31
No Partial Loading of a Operating Point	17-31
Restriction on Copying Operating Point Values	17-31
Best Practices for Saving the Operating Point of a Chart	17-32
Use MAT-Files to Save a Operating Point for Future Use	17-32
Use Scripts to Save Operating Point Commands for Future Use	17-32

Vectors and Matrices in Stateflow Charts

18

Vectors and Matrices in Stateflow Charts	18-2
Define Vector and Matrix Data	18-2
Where You Can Use Vectors and Matrices	18-2
Rules for Vectors and Matrices in Stateflow Charts	18-3
Supported Operations for Vectors and Matrices	18-4
Indexing Notation	18-4
Binary Operations	18-4
Unary Operations and Actions	18-5
Assignment Operations	18-6
Perform Matrix Arithmetic by Using MATLAB Functions	18-7

Variable-Size Data in Stateflow Charts

19

Declare Variable-Size Data in Stateflow Charts	19-2
Enable Support for Variable-Size Data	19-2
Declare Variable-Size Inputs and Outputs	19-2
Rules for Using Variable-Size Data	19-3
Compute Output Based on Size of Input Signal	19-5

Enumerated Data in Charts

20

Reference Values by Name by Using Enumerated Data	20-2
Example of Enumerated Data	20-2
Computation with Enumerated Data	20-2
Notation for Enumerated Values	20-3
Where to Use Enumerated Data	20-3
Define Enumerated Data Types	20-5
Elements of an Enumerated Data Type Definition	20-5
Define an Enumerated Data Type	20-5
Specify Data Type in the Property Inspector	20-7
Best Practices for Using Enumerated Data	20-8
Guidelines for Defining Enumerated Data Types	20-8
Guidelines for Referencing Enumerated Data	20-8
Guidelines and Limitations for Enumerated Data	20-10
Assign Enumerated Values in a Chart	20-11
Chart Behavior	20-11
Build the Chart	20-12
View Simulation Results	20-13

String Data in Charts

21

Manage Textual Information by Using Strings	21-2
Example of String Data	21-2
Computation with Strings	21-2
Where to Use Strings	21-5
Log String Data to the Simulation Data Inspector	21-6
Chart Behavior	21-6
Build the Model	21-6
View Simulation Results	21-8

Send Messages with String Data	21-10
Emitter Chart	21-10
Receiver Chart	21-10
View Simulation Results	21-11
Share String Data with Custom C Code	21-13
Simulate a Media Player by Using Strings	21-17

Continuous-Time Systems in Stateflow Charts

22

Continuous-Time Modeling in Stateflow	22-2
Configure a Stateflow Chart for Continuous-Time Simulation	22-2
Interaction with Simulink Solver	22-3
Disable Zero-Crossing Detection	22-4
Guidelines for Continuous-Time Simulation	22-4
Store Continuous State Information in Local Variables	22-7
Define Continuous-Time Variables	22-7
Compute Implicit Time Derivatives	22-7
Expose Continuous State to a Simulink Model	22-7
Guidelines for Continuous-Time Variables	22-7
Model a Bouncing Ball in Continuous Time	22-9
Model a DC Motor in Stateflow	22-13
Model the Dynamics of Moving Billiard Balls	22-15
Model Newton's Cradle	22-20
Modeling Newton's Cradle with Virtual Reality	22-24

Fixed-Point Data in Stateflow Charts

23

Fixed-Point Data in Stateflow Charts	23-2
Fixed-Point Numbers	23-2
Specify Fixed-Point Data	23-2
Conversion Operations	23-3
Fixed-Point Context-Sensitive Constants	23-4
Tips for Using Fixed-Point Data	23-5
Automatic Scaling of Fixed-Point Data	23-6
Share Fixed-Point Data with Simulink Models	23-6
Implementation of Fixed-Point Data in Stateflow	23-6
Build a Low-Pass Filter by Using Fixed-Point Data	23-8

Supported Operations for Fixed-Point Data	23-12
Binary Operations	23-12
Unary Operations and Actions	23-14
Assignment Operations	23-14
Compare Results of Fixed-Point Arithmetic	23-16
Fixed-Point Operations in Stateflow Charts	23-19
Arithmetic Operations for Fixed-Point Data	23-19
Relational Operations for Fixed-Point Data	23-19
Logical Operations for Fixed-Point Data	23-20
Promotion Rules for Fixed-Point Operations	23-20

Complex Data

24

Complex Data in Stateflow Charts	24-2
Define Complex Data	24-2
When to Use Complex Data	24-2
Where You Can Use Complex Data	24-2
How You Can Use Complex Data	24-2
Supported Operations for Complex Data	24-4
Notation for Complex Data	24-4
Binary Operations	24-4
Unary Operations and Actions	24-5
Assignment Operations	24-5
Access Real and Imaginary Parts of a Complex Number	24-5
Rules for Using Complex Data in C Charts	24-7
Best Practices for Using Complex Data in C Charts	24-9
Perform Math Function Operations with a MATLAB Function	24-9
Perform Complex Division with a MATLAB Function	24-10

Define Interfaces to Simulink Models and the MATLAB Workspace

25

Specify Properties for Stateflow Charts	25-2
Stateflow Chart Properties	25-2
Fixed-Point Properties	25-6
Additional Properties	25-7
Machine Properties	25-7
Implement Interfaces to Simulink Models	25-9
Define a Triggered Stateflow Block	25-9
Define a Sampled Stateflow Block	25-9
Define an Inherited Stateflow Block	25-10
Define a Continuous Stateflow Block	25-11

Define Function-Call Output Events	25-11
Define Edge-Triggered Output Events	25-11
Reuse Charts in Models with Chart Libraries	25-12
Create Specialized Chart Libraries for Large-Scale Modeling	25-12
Customize Properties of Library Blocks	25-12
Limitations of Library Charts	25-13
Create a Mask to Share Parameters with Simulink	25-14
Create a Mask for a Stateflow Chart	25-14
Add an Icon to the Mask	25-14
Add Parameters to the Mask	25-15
View the New Mask	25-15
Look Under the Mask	25-16
Edit the Mask	25-16
Specify Units for Stateflow Data	25-17
Units for Input and Output Data	25-17
Consistency Checking	25-17
Units for Stateflow Limitations	25-17

Structures and Bus Signals in Stateflow Charts

26

Access Bus Signals Through Stateflow Structures	26-2
Define Stateflow Structures	26-2
Specify Structure Types by Calling the type Operator	26-4
Virtual and Nonvirtual Buses	26-5
Debug Structures	26-5
Guidelines for Structure Data Types	26-5
Index and Assign Values to Stateflow Structures	26-7
Index Substructures and Fields	26-7
Assign Values to Structures and Fields	26-8
Integrate Custom Structures in Stateflow Charts	26-10
Define Custom Structures in C Code	26-10
Pass Stateflow Structures to Custom Code	26-11

Stateflow Design Patterns

27

Reduce Transient Signals by Using Debouncing Logic	27-2
Why Debounce Signals	27-2
How to Debounce a Signal	27-2
Debounce Signals with the duration Operator	27-2
Debounce Signals with Fault Detection	27-4
Use Event-Based Temporal Logic	27-7

Schedule Execution of Simulink Subsystems	27-9
When to Implement Schedulers	27-9
Types of Schedulers	27-9
Schedule Multiple Subsystems in a Single Step	27-10
Schedule a Subsystem Multiple Times in a Single Step	27-14
Schedule Subsystems to Execute at Specific Times	27-17
Implement Dynamic Test Vectors	27-20
When to Implement Test Vectors	27-20
A Dynamic Test Vector Chart	27-21
Key Behaviors of the Chart and Model	27-23
Run the Model with Stateflow Test Vectors	27-25
Map Fault Conditions to Actions by Using Truth Tables	27-28
Detect Faults in a System	27-28
Design for Isolation and Recovery in a Chart	27-31
Mode Logic for the Elevator Actuators	27-31
States for Failure and Isolation	27-32
Transitions for Recovery	27-32

Truth Table Functions for Decision-Making Logic

28

Use Truth Tables to Model Combinatorial Logic	28-2
Layout of a Truth Table	28-2
Define a Truth Table Function	28-3
Call Truth Table Functions in States and Transitions	28-4
Specify Properties of Truth Table Functions	28-4
Program a Truth Table	28-6
Open a Truth Table for Editing	28-6
Select an Action Language	28-6
Enter Truth Table Conditions	28-7
Enter Truth Table Decisions	28-8
Enter Truth Table Actions	28-9
Assign Truth Table Actions to Decisions	28-13
Add Initial and Final Actions	28-16
Generate Content for Truth Tables	28-18
Debug Errors in a Truth Table	28-19
Find Syntax Errors by Running Diagnostics	28-19
Debug Logic by Using Breakpoints	28-19
Edit Breakpoints	28-24
Debugging Generated Truth Table Content	28-25
View Generated Content for Stateflow Truth Tables	28-26
How Stateflow Software Generates Graphical Functions for Truth Tables	28-26

How Stateflow Software Generates MATLAB Code for Truth Tables . . .	28-30
Correct Overspecified and Underspecified Truth Tables	28-32
Example of an Overspecified Truth Table	28-32
Example of an Underspecified Truth Table	28-33

MATLAB Functions in Stateflow Charts

29

Reuse MATLAB Code by Defining MATLAB Functions	29-2
Define a MATLAB Function in a Chart	29-2
Declare Function Arguments and Return Values	29-3
Call MATLAB Functions in States and Transitions	29-4
Specify MATLAB Function Properties in a Chart	29-4
Program a MATLAB Function in a Chart	29-6
Build Model	29-6
Program MATLAB Functions	29-9
Connect Structures in MATLAB Functions to Simulink Bus Signals . .	29-12
About Structures in MATLAB Functions	29-12
Define Structures in MATLAB Functions	29-12
Debug a MATLAB Function in a Chart	29-14
Check MATLAB Functions for Syntax Errors	29-14
Run-Time Debugging for MATLAB Functions in Charts	29-14
Check for Data Range Violations	29-16

Simulink Functions in Stateflow Charts

30

Reuse Simulink Components in Stateflow Charts	30-2
Where to Define a Simulink Function in a Chart	30-2
Call a Simulink Function from Multiple Sites in a Chart	30-2
Rules for Using Simulink Functions in Stateflow Charts	30-3
Share Functions Across Simulink and Stateflow	30-6
Why Use a Simulink Function in a Stateflow Chart?	30-8
Advantages of Using Simulink Functions in a Stateflow Chart	30-8
Benefits of Using a Simulink Function to Access Simulink Blocks	30-8
Benefits of Using a Simulink Function to Schedule Execution of Multiple Controllers	30-10
Define a Simulink Function in a Stateflow Chart	30-13
Task 1: Add a Function to the Chart	30-13
Task 2: Define the Subsystem Elements of the Simulink Function	30-13
Task 3: Configure the Function Inputs	30-14

Bind a Simulink Function to a State	30-15
Bind Behavior of a Simulink Function	30-15
Control Subsystem Variables When the Simulink Function Is Disabled .	30-15
Example of Binding a Simulink Function to a State	30-16
Improve Chart Design by Using Simulink Functions	30-20
Goal of the Tutorial	30-20
Edit a Model to Use a Simulink Function	30-21
Run the New Model	30-26
Schedule Execution of Multiple Controllers	30-28
Goal of the Tutorial	30-28
Edit a Model to Use Simulink Functions	30-29
Run the New Model	30-33

Build Targets

31

Access Custom C++ Code in Stateflow Charts	31-2
Task 1: Prepare Code Files	31-2
Task 2: Include Custom C++ Source and Header Files for Simulation . . .	31-2
Task 3: Choose a C++ Compiler	31-3
Task 4: Simulate the Model	31-3
Access Custom C Code in Nonlibrary Charts	31-4
Task 1: Include Custom C Code in the Simulation Target	31-4
Task 2: Simulate the Model	31-5
Access Custom C Code in Library Charts	31-7
Task 1: Include Custom C Code in Simulation Targets for Library Models	
.....	31-7
Task 2: Simulate the Model	31-8
Access Custom C Code in All Charts in Model	31-9
Task 1: Include Custom C Code in the Simulation Target for the Main Model	
.....	31-9
Task 2: Ensure That Custom C Code for the Main Model Applies to Library	
Charts	31-10
Task 3: Simulate the Model	31-10
Access Custom Code Variables and Functions in Stateflow Charts	31-11
Custom Code Variables in Charts That Use MATLAB as the Action Language	
.....	31-11
Custom Code Functions in Charts That Use MATLAB as the Action	
Language	31-11
Speed Up Simulation	31-13
Improve Model Update Performance	31-13
Disable Simulation Target Options That Impact Execution Speed	31-13
Speed Up Simulation	31-13

Command-Line API to Set Simulation and Code Generation Parameters	31-15
Set Parameters at the Command Line	31-15
Simulation Parameters for Nonlibrary Models	31-15
Simulation Parameters for Library Models	31-16
Specify Relative Paths to Your Custom Code	31-18
Why Use Relative Paths?	31-18
Search Relative Paths	31-18
Path Syntax Rules	31-18
Reuse Custom Code in Stateflow Charts	31-19
Choose the Appropriate Procedure for Simulation	31-19
Use Custom Code to Define Global Constants	31-19
Use Custom Code to Define Constants, Variables, and Functions	31-20
Resolve Undefined Symbols in Your Chart	31-24
Resolve Symbols Through the Symbols Pane	31-24
Resolve Symbols Through the Symbol Wizard	31-24
Detect Symbol Definitions in Custom Code	31-25
Call Extrinsic MATLAB Functions in Stateflow Charts	31-26
coder.extrinsic Function	31-26

Code Generation

32

Generate C or C++ Code from Stateflow Blocks	32-2
Generate Code by Using Simulink Coder	32-2
Generate Code by Using Embedded Coder	32-2
Design Tips for Optimizing Generated Code for Stateflow Objects	32-3
Generate Code for Rapid Prototyping and Production Deployment	32-3
Traceability of Stateflow Objects in Generated Code	32-4
Select Array Layout for Matrices in Generated Code	32-5
Column-Major Array Layout	32-5
Row-Major Array Layout	32-6
Multidimensional Array Layout	32-6
Software Configurations Using Variant Transitions	32-8
Create a Variant Configuration	32-8
Generate Code for Variant Configurations	32-10
Using the Variant Manager	32-11
Variant Lamp Design	32-13
Generate Code from Atomic Subcharts	32-14
Generate Reusable Code for Unlinked Atomic Subcharts	32-14
Generate Reusable Code for Linked Atomic Subcharts	32-14

Debugging Stateflow Charts	33-2
Set Breakpoints to Debug Charts	33-3
Set a Breakpoint for a Stateflow Object	33-3
Change Breakpoint Types	33-5
Add Breakpoint Conditions	33-5
Manage Breakpoints Through the Breakpoints and Watch Window	33-7
Inspect and Modify Data and Messages While Debugging	33-9
View Data in the Stateflow Editor	33-9
View and Modify Data in the Symbols Pane	33-10
View Data in the Breakpoints and Watch Window	33-11
View and Modify Data in the MATLAB Command Window	33-12
Control Chart Execution After a Breakpoint	33-16
Examine the State of the Chart	33-16
Step Through the Simulation	33-17
Debug Run-Time Errors in a Chart	33-20
Create the Model and the Stateflow Chart	33-20
Debug the Stateflow Chart	33-21
Correct the Run-Time Error	33-21
Animate Stateflow Charts	33-23
Set Animation Speeds	33-23
Maintain Highlighting	33-23
Disable Animation	33-23
Animate Charts as Generated Code Executes on a Target System	33-23
Detect Modeling Errors During Edit Time	33-24
Manage Edit-Time Checks	33-24
Edit-Time Checks on States	33-24
Edit-Time Checks on Transitions	33-26
Edit-Time Checks on Junctions	33-31
Edit-Time Checks on Functions	33-33
Detect Common Modeling Errors During Chart Simulation	33-35
State Inconsistencies	33-35
Data Range Violations	33-36
Cyclic Behavior	33-37
Avoid Unwanted Recursion in a Chart	33-39
Recursive Function Calls	33-39
Undirected Local Event Broadcasts	33-39
Monitor Test Points in Stateflow Charts	33-41
Log Simulation Output for States and Data	33-45
Enable Signal Logging	33-45
Configure States and Data for Logging	33-45
Access Signal Logging Data	33-48

Log Multidimensional Data	33-50
Limitations on Logging Data	33-50
Log Data in Library Charts	33-52
How Library Log Settings Influence Linked Instances	33-52
Override Logging Properties in Chart Instances	33-52
Override Logging Properties in Atomic Subcharts	33-52
Commenting Stateflow Objects in a Chart	33-56
Comment Out a Stateflow Object	33-56
How Commenting Affects the Chart and Model	33-56
Add Text to a Commented Object	33-58
Limitations on Commenting Objects	33-58

Explore and Modify Charts

34

Manage Data, Events, and Messages in the Symbols Pane	34-2
Add and Modify Data, Events, and Messages	34-3
Detect Unused Data in the Symbols Pane	34-3
Trace Data, Events, and Messages	34-4
Symbols Pane Limitations	34-8
Use the Model Explorer with Stateflow Objects	34-10
View Stateflow Objects in the Model Explorer	34-10
Edit Chart Objects in the Model Explorer	34-11
Add Data and Events in the Model Explorer	34-11
Rename Objects in the Model Explorer	34-11
Set Properties for Chart Objects in the Model Explorer	34-11
Move and Copy Data and Events in the Model Explorer	34-12
Change the Port Order of Input and Output Data and Events	34-13
Delete Data and Events in the Model Explorer	34-13
Use the Search and Replace Tool	34-14
Open the Search & Replace Tool	34-14
Refine Searches	34-15
Specify the Search Scope	34-16
Use the Search Button and View Area	34-17
Specify the Replacement Text	34-20
Use Replace Buttons	34-20
Search and Replace Messages	34-21

Standalone Stateflow Charts for Execution in MATLAB

35

Create Stateflow Charts for Execution as MATLAB Objects	35-2
Construct a Standalone Chart	35-2
Create a Stateflow Chart Object	35-2
Execute a Standalone Chart	35-2

Stop Chart Execution	35-3
Share Standalone Charts	35-3
Properties and Functions of Stateflow Chart Objects	35-4
Capabilities and Limitations	35-6
Execute and Unit Test Stateflow Chart Objects	35-8
Example of a Standalone Stateflow Chart	35-8
Execute a Standalone Chart from the Stateflow Editor	35-8
Execute a Standalone Chart in MATLAB	35-9
Execute Multiple Chart Objects	35-12
Debug a Standalone Stateflow Chart	35-13
Set and Clear Breakpoints	35-13
Manage Breakpoint Types and Conditions	35-14
Control Chart Execution After a Breakpoint	35-15
Examine and Change Values of Chart Data	35-17
Execute Stateflow Chart Objects Through Scripts and Models	35-18
Count Ways to Make Change for Currency	35-18
Execute Standalone Chart in a MATLAB Script	35-19
Execute Standalone Chart in a Simulink Model	35-20
Design Human-Machine Interface Logic by Using Stateflow Charts	35-24
Model a Communications Protocol by Using Chart Objects	35-28
Implement a Financial Strategy by Using Stateflow	35-32
Automate Control of Intelligent Vehicles by Using Stateflow Charts	35-35
Create an App for Analog Triggered Data Acquisition by Using Stateflow Charts	35-39

Semantic Rules Summary

A

Summary of Chart Semantic Rules	A-2
Enter a Chart	A-2
Execute an Active Chart	A-2
Enter a State	A-2
Execute an Active State	A-3
Exit an Active State	A-3
Execute a Set of Flow Charts	A-3
Execute an Event Broadcast	A-4

Semantic Examples

B

Categories of Semantic Examples	B-2
--	------------

Transition Between Exclusive States	B-4
Label Format for a State-to-State Transition	B-4
Transition from State to State with Events	B-4
Transition from a Substate to a Substate with Events	B-7
Control Chart Execution by Using Condition Actions	B-9
Condition Action Behavior	B-9
Condition and Transition Action Behavior	B-9
Create Condition Actions Using a For-Loop	B-10
Broadcast Events to Parallel (AND) States Using Condition Actions	B-11
Avoid Cyclic Behavior	B-12
Control Chart Execution by Using Default Transitions	B-14
Default Transition in Exclusive (OR) Decomposition	B-14
Default Transition to a Junction	B-14
Default Transition and a History Junction	B-15
Labeled Default Transitions	B-16
Process Events in States Containing Inner Transitions	B-18
Process Events with an Inner Transition in an Exclusive (OR) State	B-18
Process Events with an Inner Transition to a Connective Junction	B-20
Inner Transition to a History Junction	B-21
Represent Multiple Paths by Using Connective Junctions	B-23
Label Format for Transition Segments	B-23
If-Then-Else Decision Construct	B-23
Self-Loop Transition	B-24
For-Loop Construct	B-25
Flow Chart Notation	B-26
Transition from a Common Source to Multiple Destinations	B-28
Resolve Equally Valid Transition Paths	B-28
Transition from Multiple Sources to a Common Destination	B-29
Transition from a Source to a Destination Based on a Common Event	B-30
Backtrack in Flow Charts	B-30
Control Chart Execution by Using Event Actions in a Superstate	B-32
Undirected Broadcast Events in Parallel States	B-33
Broadcast Events in State Actions	B-33
Broadcast Events in Transition Actions	B-34
Broadcast Events in Condition Actions	B-36
Broadcast Local Events in Parallel States	B-39
Directed Event Broadcast Using Send	B-39
Directed Event Broadcast Using Qualified Event Name	B-40

Glossary

Stateflow Chart Concepts

- “Finite State Machine Concepts” on page 1-2
- “The Stateflow Chart” on page 1-4
- “How the Stateflow Chart Works with the Simulink Model” on page 1-7
- “A Look at the Physical Plant” on page 1-8
- “Running the Model” on page 1-10
- “Implementing the Interface with Simulink” on page 1-12
- “Implementing the States to Represent Operating Modes” on page 1-23
- “Adding the Transitions” on page 1-33
- “Implementing the Triggers” on page 1-44
- “Setting Simulation Parameters and Breakpoints” on page 1-47
- “Debugging Common Modeling Errors” on page 1-54

Finite State Machine Concepts

Stateflow charts can contain sequential decision logic based on state machines. A finite state machine is a representation of an event-driven (reactive) system. In an event-driven system, the system makes a transition from one state (mode) to another, if the condition defining the change is true.

For example, you can use a state machine to represent the automatic transmission of a car. The transmission has these operating states: park, reverse, neutral, drive, and low. As the driver shifts from one position to another, the system makes a transition from one state to another, for example, from park to reverse.

Finite State Machine Representations

Traditionally, designers used truth tables to represent relationships among the inputs, outputs, and states of a finite state machine. The resulting table describes the logic necessary to control the behavior of the system under study. Another approach to designing event-driven systems is to model the behavior of the system by describing it in terms of transitions among states. The occurrence of events under certain conditions determine the state that is active. State-transition charts and bubble charts are graphical representations based on this approach.

Stateflow Chart Representations

A Stateflow chart can contain sequential and combinatorial logic in the form of state transition diagrams, flow charts, state transition tables, and truth tables. A state transition diagram is a graphical representation of a finite state machine. States and transitions form the basic building blocks of a sequential logic system. Another way to represent sequential logic is a state transition table, which allows you to enter the state logic in tabular form. You can also represent combinatorial logic in a chart with flow charts and truth tables.

You can include Stateflow charts as blocks in a Simulink® model. The collection of these blocks in a Simulink model is the Stateflow machine.

A Stateflow chart enables the representation of hierarchy, parallelism, and history. You can organize complex systems by defining a parent and offspring object structure. For example, you can organize states within other higher-level states. A system with parallelism can have two or more orthogonal states active at the same time. You can also specify the destination state of a transition based on historical information.

Notation

Notation defines a set of objects and the rules that govern the relationships between those objects. Stateflow chart notation provides a way to communicate the design information in a Stateflow chart.

Stateflow chart notation consists of these elements:

- A set of graphical objects
- A set of nongraphical text-based objects
- Defined relationships between those objects

Semantics

Semantics describe how to interpret chart notation. A typical Stateflow chart contains actions associated with transitions and states. The semantics describe the sequence of these actions during chart execution.

Bibliography

[1] Harel, D "Statecharts: A Visual Formalism for Complex Systems." *Science of Computer Programming* Vol. 8, 1987, pp. 231-274.

[2] Hatley, D. J. and I. A. Pirbhai. *Strategies for Real-Time System Specification*. New York, NY: Dorset House Publishing, 1988.

See Also

Chart | State Transition Table | Truth Table

More About

- "Overview of Stateflow Objects" on page 2-2
- "Model Reactive Systems in Stateflow" on page 4-2
- "How Stateflow Objects Interact During Execution" on page 3-5
- "Specify Properties for Stateflow Charts" on page 25-2

The Stateflow Chart

To get hands-on experience using Stateflow software, you will build a Stateflow chart in incremental steps that follow the basic workflow described in “Model Reactive Systems in Stateflow” on page 4-2.

You will build a Stateflow chart that maintains air temperature at 120 degrees in a physical plant. The Stateflow controller operates two fans. The first fan turns on if the air temperature rises above 120 degrees and the second fan provides additional cooling if the air temperature rises above 150 degrees. When completed, your Stateflow chart should look something like this:

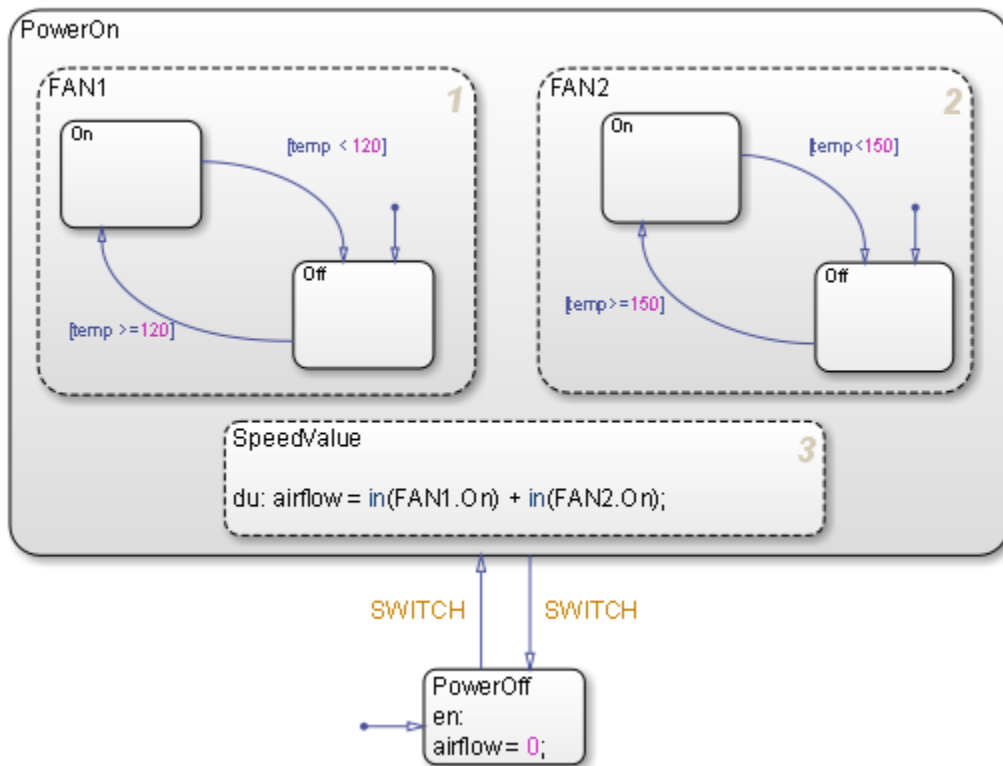

As you can see from the title bar, the chart is called Air Controller and is part of a Simulink model called sf_aircontrol. When you build this chart, you will learn how to work with the following elements of state-transition charts:

Exclusive (OR) states. States that represent mutually exclusive modes of operation. No two exclusive (OR) states can ever be active or execute at the same time. Exclusive (OR) states are represented graphically by a solid rectangle:



The Air Controller chart contains six exclusive (OR) states:

- PowerOn
- PowerOff
- FAN1.On
- FAN1.Off
- FAN2.On
- FAN2.Off

Parallel (AND) states. States that represent independent modes of operation. Two or more parallel (AND) states at the same hierarchical level can be active concurrently, although they execute in a serial fashion. Parallel (AND) states are represented graphically by a dashed rectangle with a number indicating execution order:

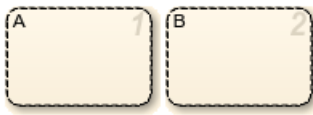

The Air Controller chart contains three parallel (AND) states:

- FAN1
- FAN2
- SpeedValue

Transitions. Graphical objects that link one state to another and specify a direction of flow. Transitions are represented by unidirectional arrows:



The Air Controller chart contains six transitions, from

- PowerOn to PowerOff
- PowerOff to PowerOn
- FAN1.On to FAN1.Off
- FAN1.Off to FAN1.On
- FAN2.On to FAN2.Off
- FAN2.Off to FAN2.On

Default transitions. Graphical objects that specify which exclusive (OR) state is to be active when there is ambiguity between two or more exclusive (OR) states at the same level in the hierarchy. Default transitions are represented by arrows with a closed tail:



The Air Controller chart contains default transitions:

- At the chart level, the default transition indicates that the state PowerOff is activated (wakes up) first when the chart is activated.

- In the FAN1 and FAN2 states, the default transitions specify that the fans be powered off when the states are activated.

State actions. Actions executed based on the status of a state.

The Air Controller chart contains two types of state actions:

- **entry (en)** action in the PowerOff state. Entry actions are executed when the state is entered (becomes active).
- **during (du)** action in the SpeedValue state. During actions are executed for a state while it is active and no valid transition to another state is available.

Other types of state actions

There are other types of state actions besides **entry** and **during**, but they involve concepts that go beyond the scope of this guide. For more information, see “Syntax for States and Transitions”.

Conditions. Boolean expressions that allow a transition to occur when the expression is true. Conditions appear as labels for the transition, enclosed in square brackets ([]).

The Air Controller chart provides conditions on the transitions between FAN1.On and FAN1.Off, and between FAN2.On and FAN2.Off, based on the air temperature of the physical plant at each time step.

Events. Objects that can trigger a variety of activities, including:

- Waking up a Stateflow chart
- Causing transitions to occur from one state to another (optionally in conjunction with a condition)
- Executing actions

The Air Controller chart contains two edge-triggered events:

- **CLOCK** wakes up the Stateflow chart at each rising or falling edge of a square wave signal.
- **SWITCH** allows transitions to occur between PowerOff and PowerOn at each rising or falling edge of a pulse signal.

How the Stateflow Chart Works with the Simulink Model

The Stateflow chart you will build appears as a block named Air Controller that is connected to the model of a physical plant in the Simulink `sf_aircontrol` model. Here is the top-level view of the model:

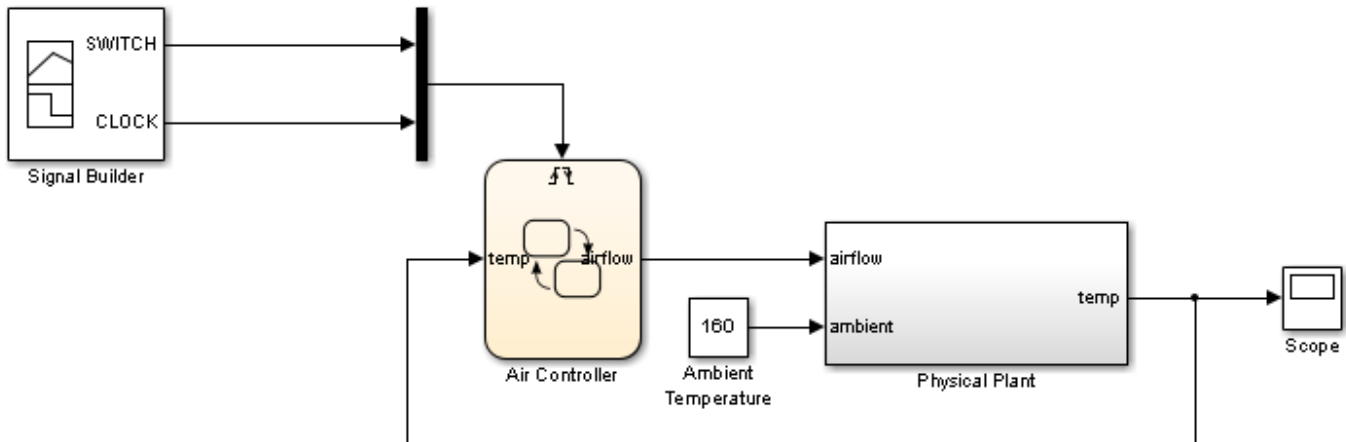

The Simulink model passes the temperature of the plant as an input `temp` to the Stateflow Air Controller block. Based on the temperature of the plant, the controller activates zero, one, or two fans, and passes back to the model an output value `airflow` that indicates how fast the air is flowing. The amount of cooling activity depends on the speed of the fans. As air flows faster, cooling activity increases. The model uses the value of `airflow` to simulate the effect of cooling when it computes the air temperature in the plant over time.

The Signal Builder block in the Simulink model sends a square wave signal (`CLOCK`) to wake up the Stateflow chart at regular intervals and a pulse signal (`SWITCH`) to cycle the power on and off for the control system modeled by the Stateflow chart. You will learn more about these design elements in “Implementing the Triggers” on page 1-44.

A Look at the Physical Plant

Simulink software models the plant using a subsystem called Physical Plant, which contains its own group of Simulink blocks. The subsystem provides a graphical hierarchy for the blocks that define the behavior of the Simulink model. The inputs, airflow speed and ambient temperature, model the effects of the controller activity on plant temperature. Here is a look inside the Physical Plant subsystem:

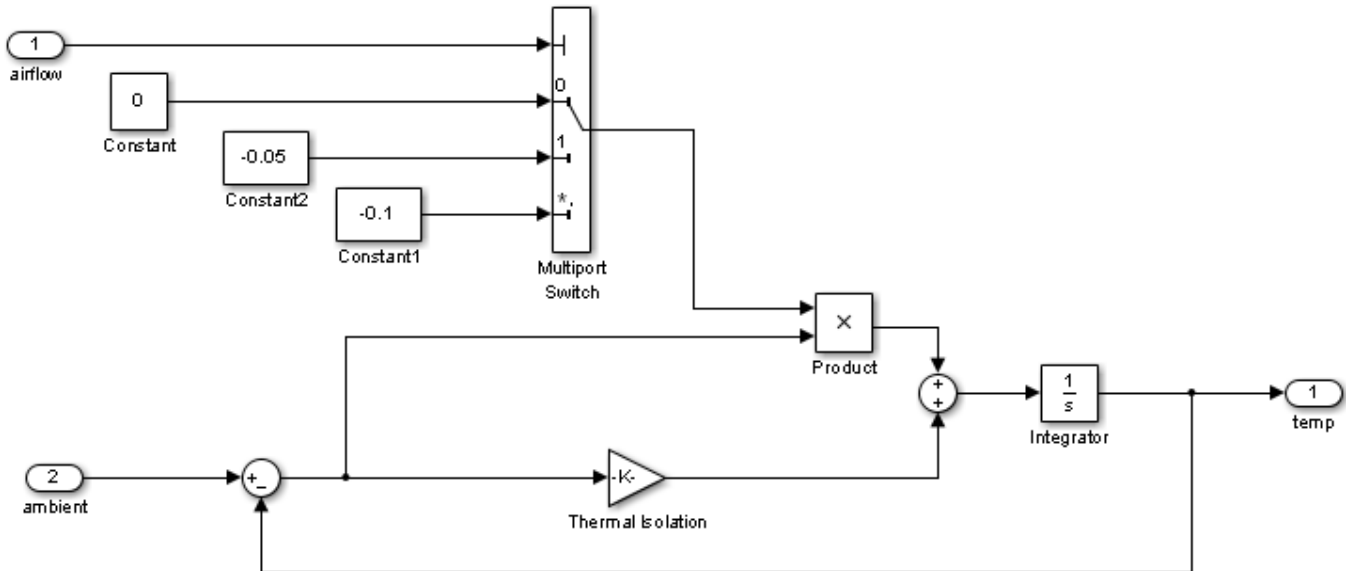

In this model, the internal temperature of the plant attempts to rise to achieve steady state with the ambient air temperature, set at a constant 160 degrees (as shown in “How the Stateflow Chart Works with the Simulink Model” on page 1-7). The rate at which the internal temperature rises depends in part on the degree of thermal isolation in the plant and the amount of cooling activity.

Thermal isolation measures how much heat flows into a closed structure, based on whether the structure is constructed of materials with insulation or conduction properties. Here, thermal isolation is represented by a Gain block, labeled `Thermal Isolation`. The Gain block provides a constant multiplier that is used in calculating the temperature in the plant over time.

Cooling activity is modeled using a constant multiplier, derived from the value of `airflow`, an output from the Stateflow chart. The chart assigns `airflow` one of three cooling factors, each a value that serves as an index into a multiport switch. Using this index, the multiport switch selects a cooling activity multiplier that is directly proportional to the cooling factor, as follows:

Cooling Factor (Value of Airflow)	What It Means	Cooling Activity
0	No fans are running. The value of <code>temp</code> is not lowered.	0
1	One fan is running. The value of <code>temp</code> is lowered by the cooling activity multiplier.	-0.05

Cooling Factor (Value of Airflow)	What It Means	Cooling Activity
2	Two fans are running. The value of <code>temp</code> is lowered by the cooling activity multiplier.	-0.1

Over time, the subsystem calculates the cooling effect inside the plant, taking into account thermal isolation and cooling activity. The cooling effect is the time-derivative of the temperature and is the input to the Integrator block in the Physical Plant subsystem. Let the variable `temp_change` represent the time derivative of temperature. Note that `temp_change` can be a warming or cooling effect, depending on whether it is positive or negative, based on this equation:

$$temp_change = ((ambient - temp) * (thermalisolationmultiplier)) + ((ambient - temp) * (coolingfactor))$$

The Integrator block computes its output `temp` from the input `temp_change`, as follows:

$$temp(t) = \int_{t_0}^t temp_change(t)dt + 70$$

Note In this model, the initial condition of the Integrator block is 70 degrees.

`temp` is passed back to the Stateflow Air Controller chart to determine how much cooling is required to maintain the ideal plant temperature.

Running the Model

To see how the `sf_aircontrol` model works, you can run a completed, tested version, which includes the Stateflow chart you will build. Here's how to do it:

- 1 Start MATLAB® software.

If you need instructions, consult your MATLAB documentation.

- 2 Type `sf_aircontrol` at the command line.

This command starts Simulink software and opens the `sf_aircontrol` model:

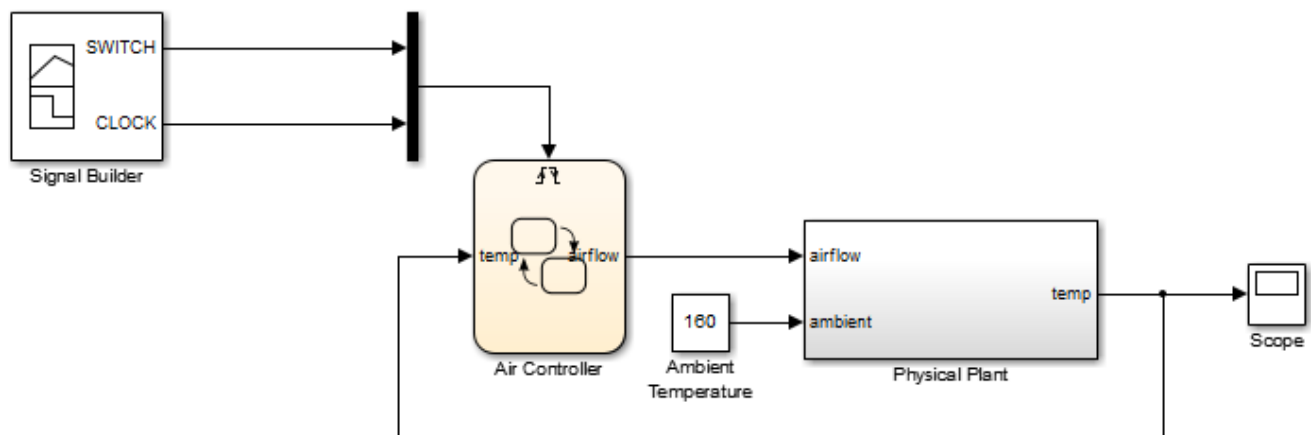

- 3 Double-click the Air Controller block to open the Stateflow chart.
- 4 Double-click the Scope block to display the changes in temperature over time as the model runs.

Tip Position the Air Controller chart and the Scope window so they are both visible on your desktop.

- 5 Start simulation in the Air Controller chart by selecting **Run**.

As the simulation runs, the chart becomes active (wakes up) in the `PowerOff` state. Notice in the Scope that until `PowerOn` becomes active, the temperature rises unchecked. After approximately 350 seconds into the simulation, a rising edge signal switches power on and the fans become active.

Note Simulation time can be faster than elapsed time.

When the temperature rises above 120 degrees, `FAN1` cycles on. When the temperature exceeds 150 degrees, `FAN2` cycles on to provide additional cooling. Ultimately, `FAN1` succeeds in maintaining the temperature at 120 degrees until a falling edge signal switches power off again at 500 seconds. Then, the temperature begins to rise again.

The Scope captures the temperature fluctuations:

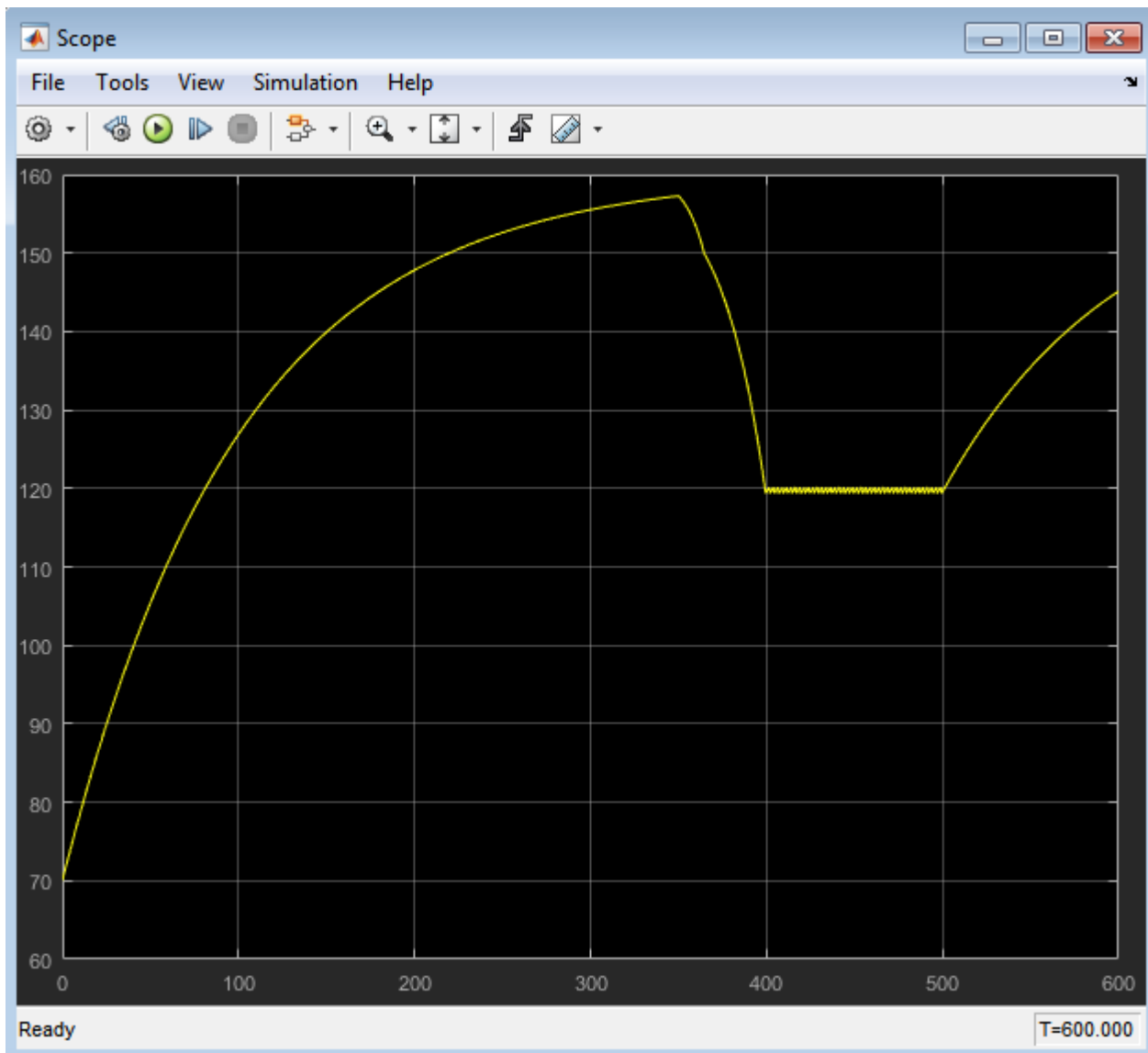

Stopping or pausing simulation

You can stop or pause simulation at any time.

- To stop simulation, select **Stop**.
- To pause simulation, select **Pause**.

6 Close the model.

Where to go next. Now you are ready to start building the Air Controller chart. Begin at phase 1 of the workflow: “Implementing the Interface with Simulink” on page 1-12.

Implementing the Interface with Simulink

In phase 1 of this workflow, you *define the interface to the Simulink model*.

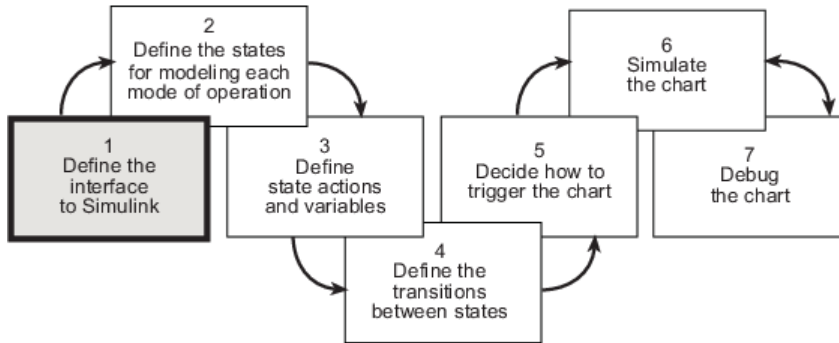

Build It Yourself or Use the Supplied Model

To implement the interface yourself, work through the exercises in this section. Otherwise, open the supplied model by entering this command at the MATLAB prompt:

```
addpath(fullfile(docroot, 'toolbox', 'stateflow', 'gs', 'examples'))
StageInterface
```

Design Considerations for Defining the Interface

The following sections describe the rationale for the input and output of the Stateflow chart.

Inputs Required from Simulink Model

Type of Input. Temperature of the physical plant

Rationale. The purpose of the chart is to control the air temperature in a physical plant. The goal is to maintain an ideal temperature of 120 degrees by activating one or two cooling fans if necessary. The chart must check the plant temperature over time to determine the amount of cooling required.

Properties of Input. The properties of the temperature input are as follows:

Property	Value
Name	temp
Scope	Input
Size	Inherit from Simulink input signal for compatibility
Data type	Inherit from Simulink input signal for compatibility
Port	1

Outputs Required from Stateflow Chart

Type of Output. Speed of airflow, based on how many fans are operating

Rationale. When the Simulink subsystem determines the temperature of the physical plant over time, it needs to account for the speed of the airflow. Airflow speed is directly related to the amount of cooling activity generated by the fans. As more fans are activated, cooling activity increases and

air flows faster. To convey this information, the Stateflow chart outputs a value that indicates whether 0, 1, or 2 fans are running. The Simulink subsystem uses this value as an index into a multiplex switch, which outputs a cooling activity value, as described in “A Look at the Physical Plant” on page 1-8.

Properties of Output. The properties of the airflow output are as follows:

Property	Value
Name	airflow
Scope	Output
Data type	8-bit unsigned integer (uint8) (The values can be only 0, 1, or 2.)
Port	1

Adding a Stateflow Block to a Simulink Model

To begin building your Stateflow chart, you will add a Stateflow block to a partially built Simulink model called `sf_aircontrol_exercise`, which contains the Physical Plant subsystem, described in “A Look at the Physical Plant” on page 1-8.

To add a Stateflow block to an existing Simulink model:

- 1 Open the Simulink model by typing `sf_aircontrol_exercise` at the MATLAB command prompt.

The model opens on your desktop:

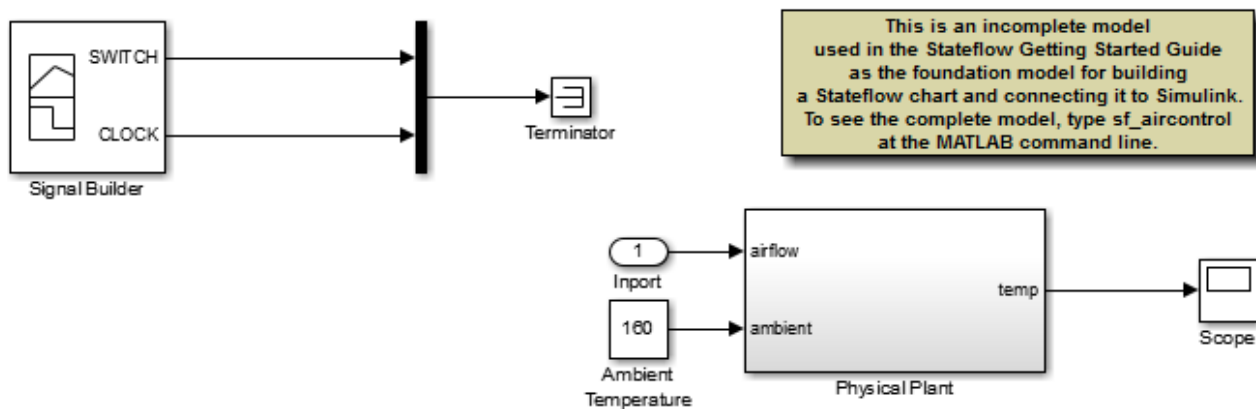

The model is incomplete because it does not include the Stateflow chart that you will build as you work through the exercises in this guide. Instead, the model contains several nonfunctional blocks: the Terminator, Inport, and Annotation blocks.

- 2 Delete the nonfunctional blocks and their connectors.

Tip Hold down the **Shift** key to select multiple objects, and then press **Delete**.

Your model should now look like this:

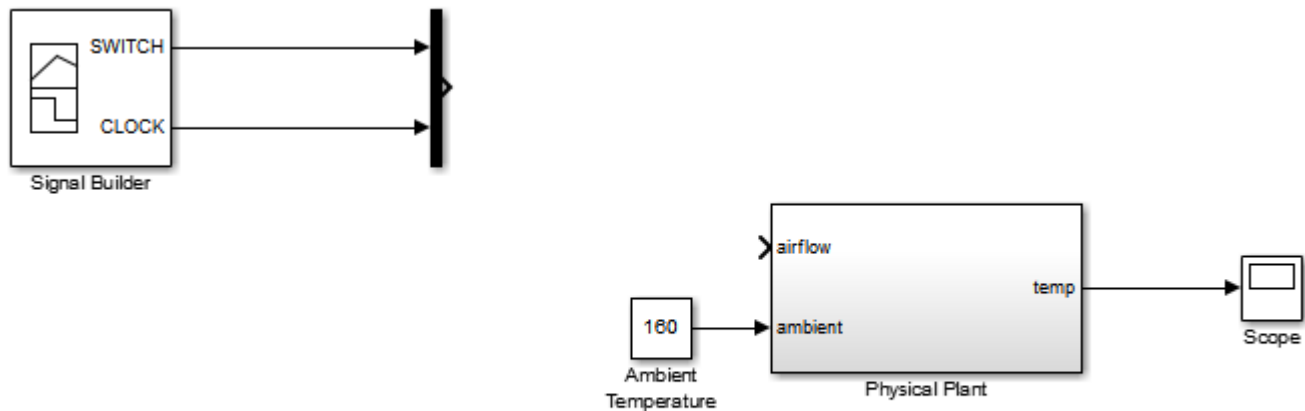

- 3 Save the model as **Stage1Interface**:
 - a Create a *new* local folder for storing your working model.
 - b In the **Simulation** tab, select **Save > Save As**.
 - c Navigate to the new folder.
 - d Enter `Stage1Interface` as the file name.
 - e Leave the default type as **Simulink Models**.
 - f Click **Save**.
- 4 On the toolbar of the Simulink model, click the Library Browser icon:



The Simulink Library Browser opens on your desktop:

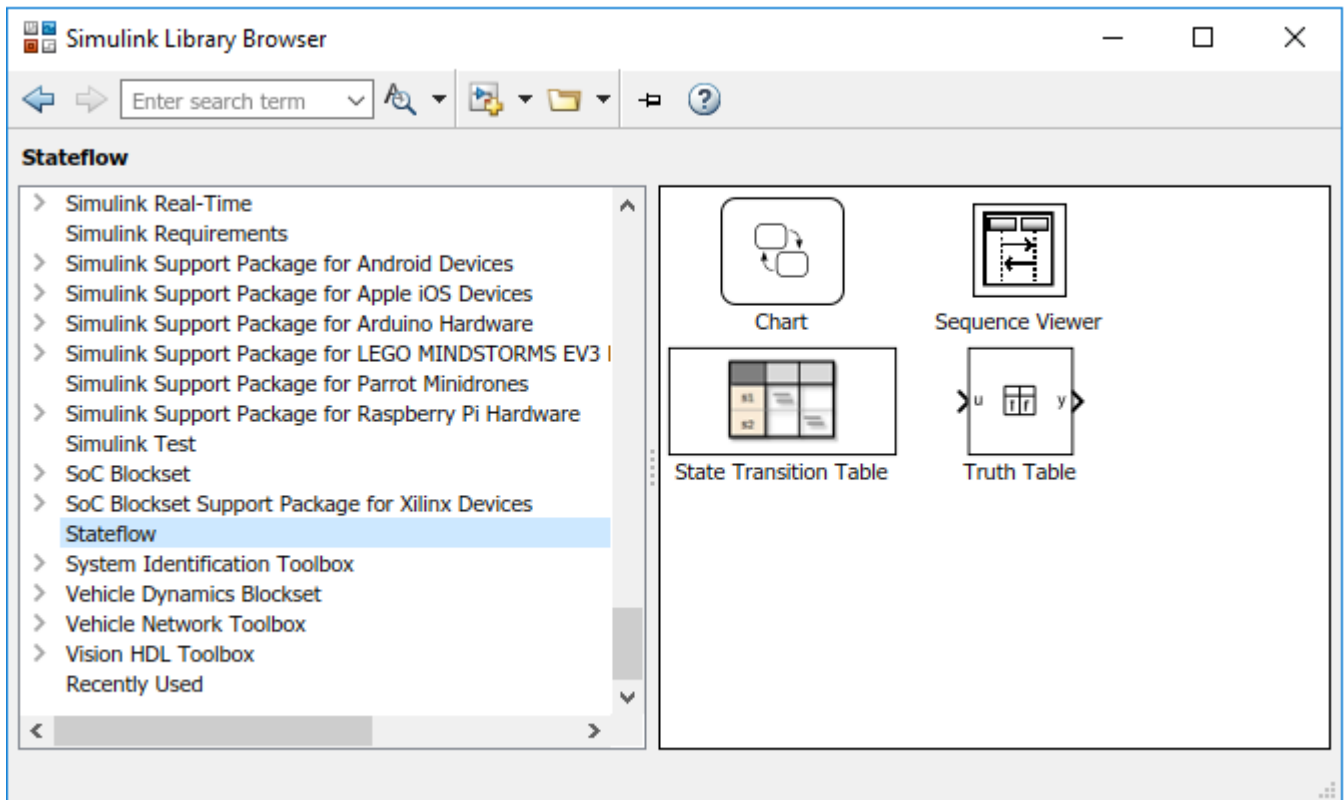

- 5 Add the Stateflow Chart block to the Simulink model:
 - a In the left scroll pane of the Library Browser, select **Stateflow**.
 - b Drag the first block, called **Chart**, into your model.

The model should now look like this:

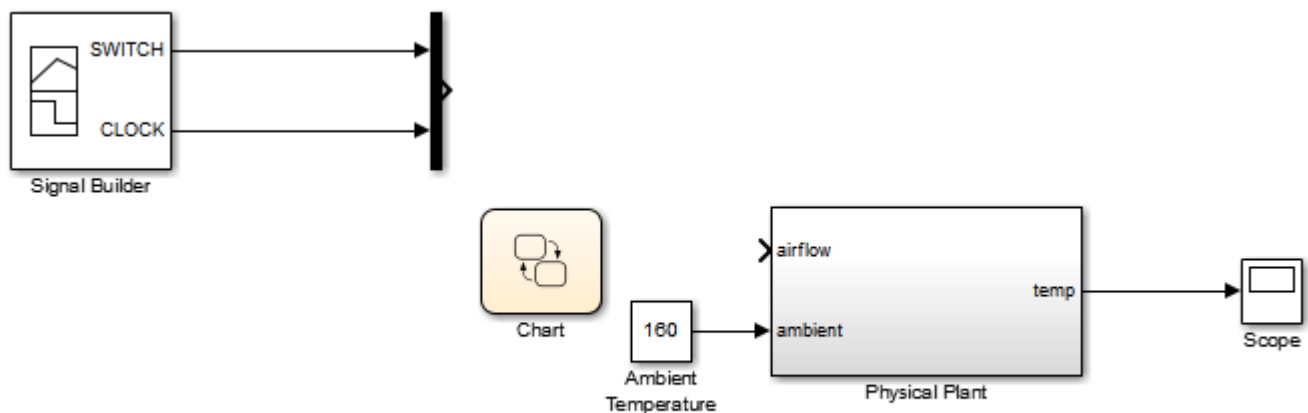

- 6 Click the label **Chart** under the Stateflow block and rename it **Air Controller**.
- 7 Change the action language of the chart to **C**:
 - a Double-click the block to open the chart.
 - b Right click in an empty area of the chart and select **Properties**.
 - c From the **Action Language** box, select **C**.
 - d Select **OK**.

Shortcut for adding a Stateflow block to a new Simulink model

At the MATLAB command prompt, enter this command:

```
sfnew
```

A new, untitled Simulink model opens on your desktop, automatically configured with a Stateflow chart. For more information, see `sfnew`.

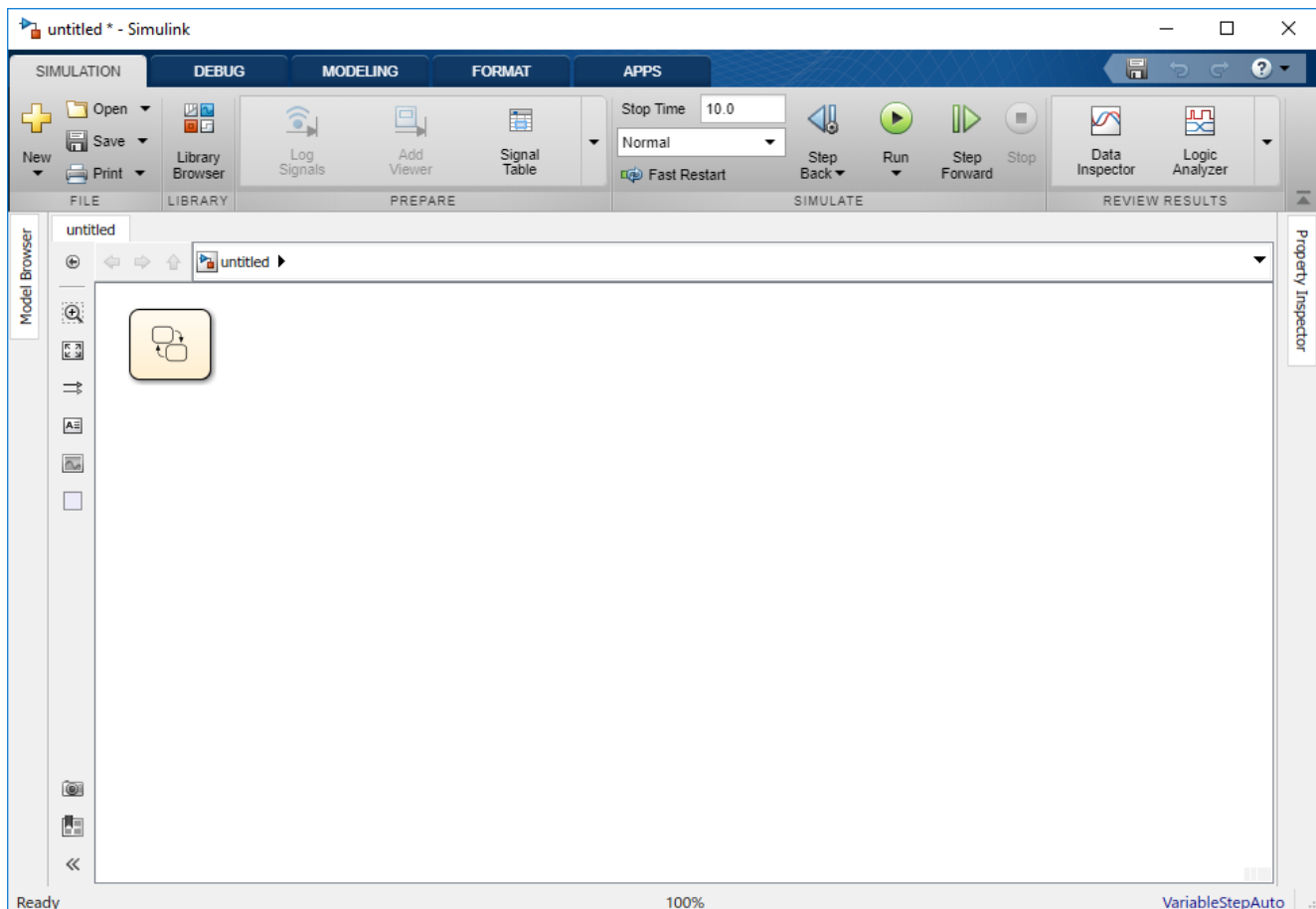

Defining the Inputs and Outputs

Inputs and outputs are data elements in a Stateflow chart that interact with the parent Simulink model. To define inputs and outputs for your chart, follow these steps:

- 1 Double-click the Air Controller block in the Simulink model Stage1Interface to open the Stateflow chart.

The Stateflow Editor opens on your desktop:

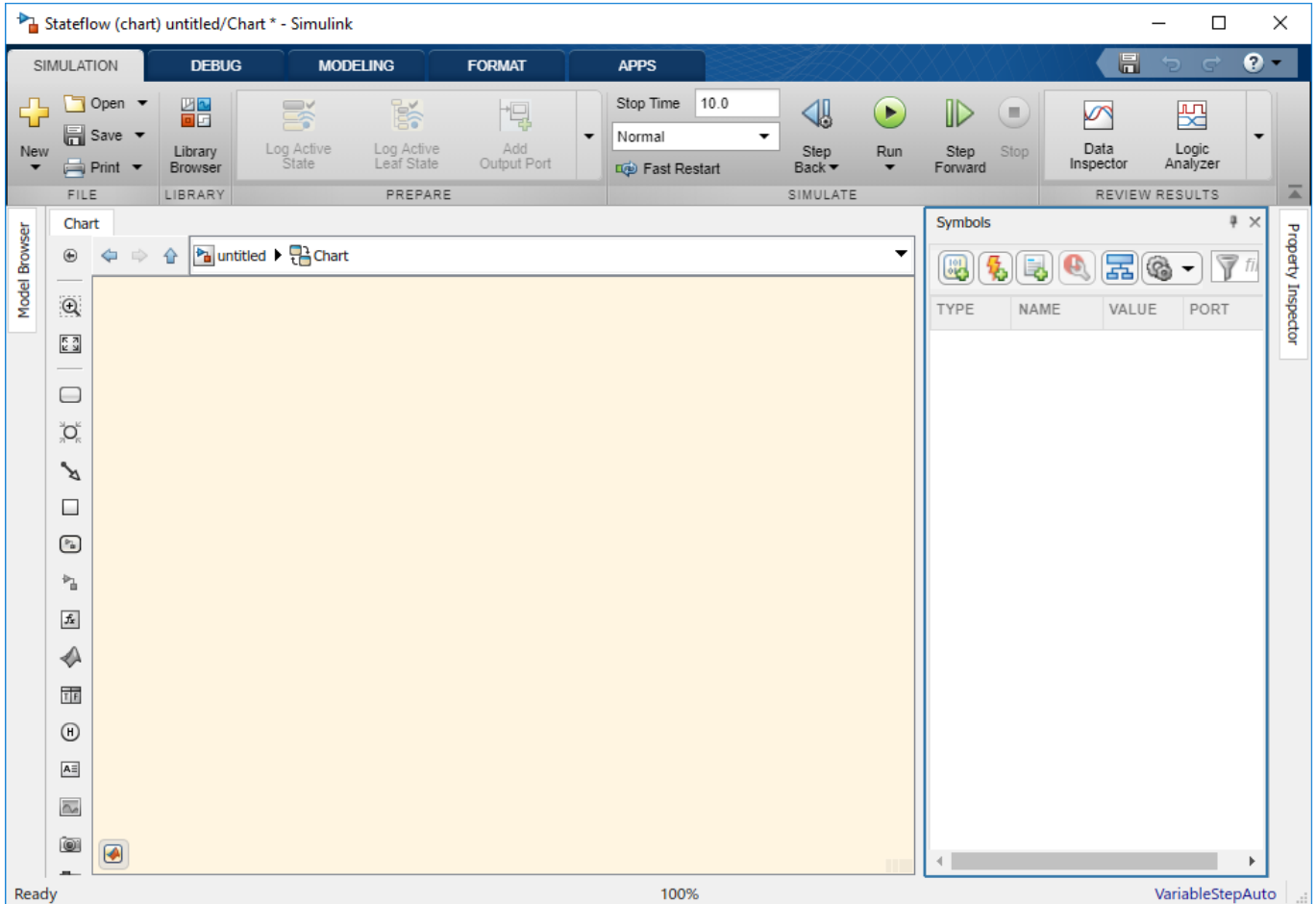

- 2 Add a data element to hold the value of the temperature input from the Simulink model:
 - a In the **Modeling** tab, under **Design Data**, select **Data Input**.

The Data properties dialog box opens on your desktop with the **General** tab selected:

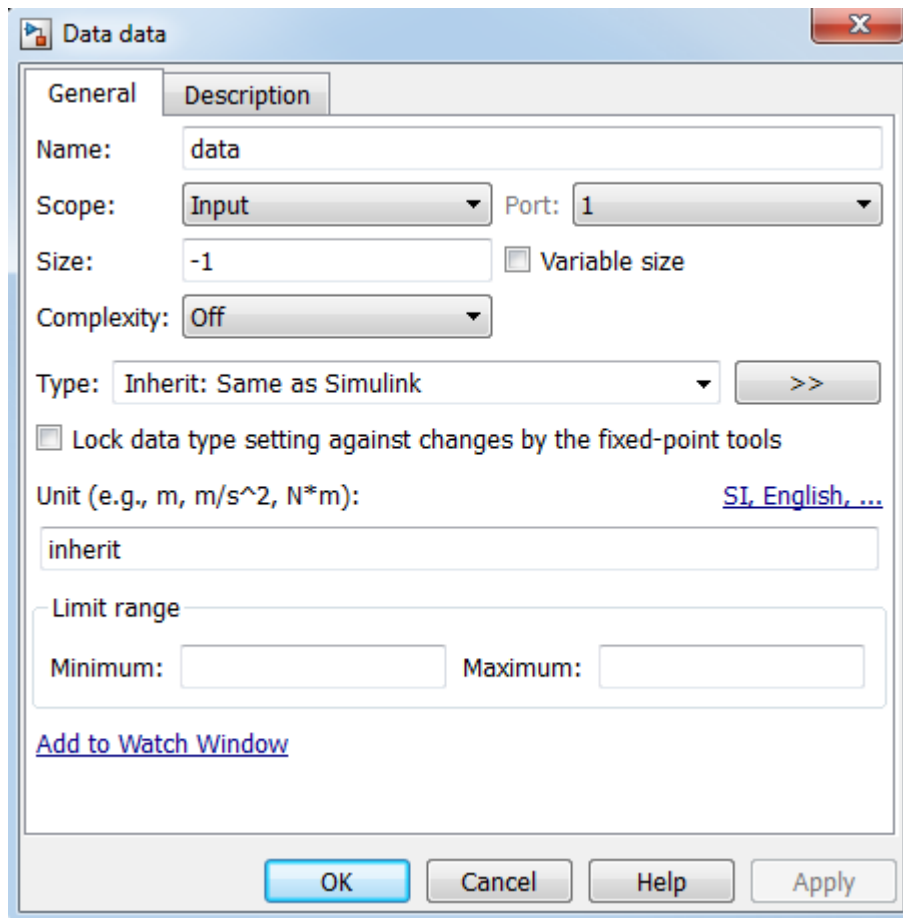

The default values in the dialog box depend on the scope — in this case, a data input.

- b In the **Name** field, change the name of the data element to **temp**.
- c Leave the following fields at their default values in the **General** tab because they meet the design requirements:

Field	Default Value	What It Means
Scope	Input	Input from Simulink model. The data element gets its value from the Simulink signal on the same input port.
Size	-1	The data element inherits its size from the Simulink signal on the same port.
Complexity	Off	The data element does not contain any complex values.
Type	Inherit: Same as Simulink	The data element inherits its data type from the Simulink signal on the same output port.

Note Ports are assigned to inputs and outputs in the order they are created. Because *temp* is the first *input* you created, it is assigned to *input port 1*.

- d In the **General** tab, select **Add to watch window**.

The Stateflow Breakpoints and Watch window lets you examine the value of `temp` during breakpoints in simulation. You will try this in “Setting Simulation Parameters and Breakpoints” on page 1-47.

- e Click **OK** to apply the changes and close the dialog box.

- 3 Add a data element to hold the value of the airflow output from the Air Controller chart:

- a In the **Modeling** tab, under **Design Data**, select **Data Output**.

The Data properties dialog box opens on your desktop, this time with different default values, associated with the scope **Output**:

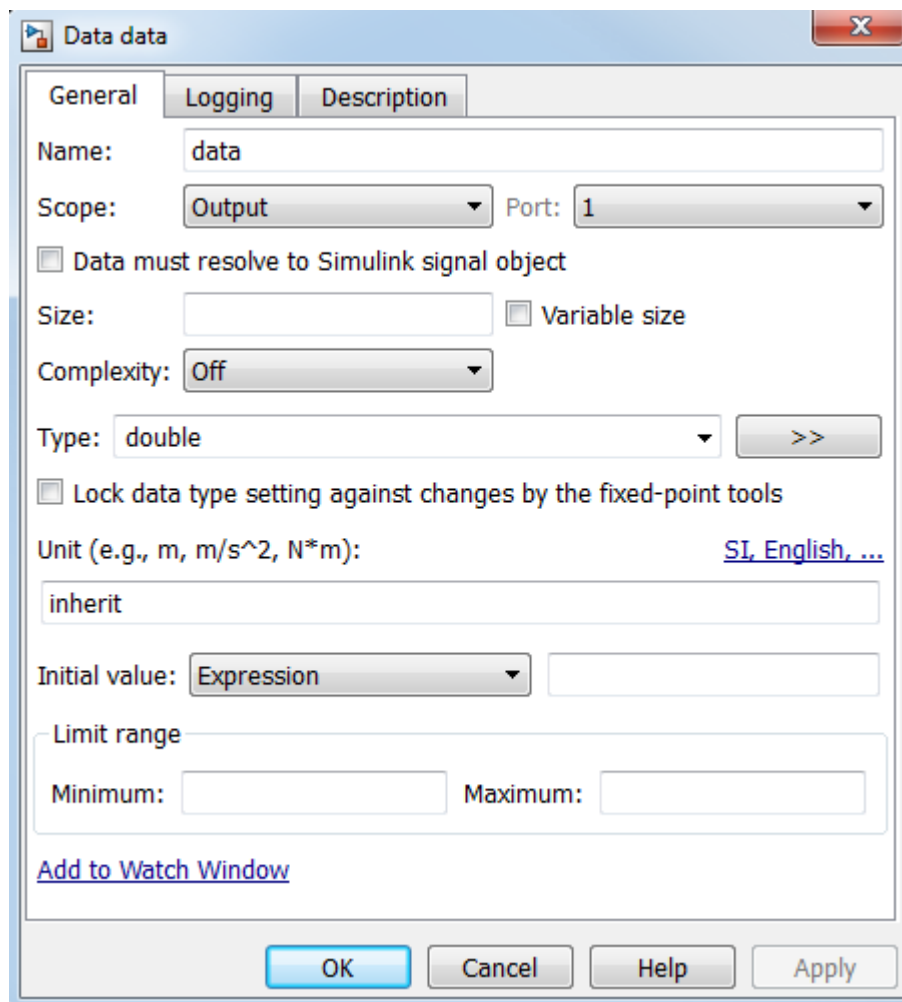

Note Because `airflow` is the first *output* you created, it is assigned to *output port 1*.

- b In the **Name** field of the Data properties dialog box, change the name of the data element to `airflow`.
- c In the **Type** field, select `uint8` (8-bit unsigned integer) from the submenu.
- d Look at the **Initial value** field.

The initial value is a blank expression, which indicates a default value of zero, based on the data type. This value is consistent with the model design, which specifies that no fans are running when the chart wakes up for the first time.

- e Make the following changes for other properties in the **General** tab:

Property	What to Specify
Limit range	Enter 0 for Minimum and 2 for Maximum .
Add to watch window	Select this to add <code>airflow</code> to the Watch tab of the Stateflow Breakpoints and Watch window.

- f Click **OK** to apply the changes and close the dialog box.

- 4 Go back to the Simulink model by clicking the up-arrow button in the Stateflow Editor toolbar.

Notice that the input `temp` and output `airflow` have been added to the Stateflow block:

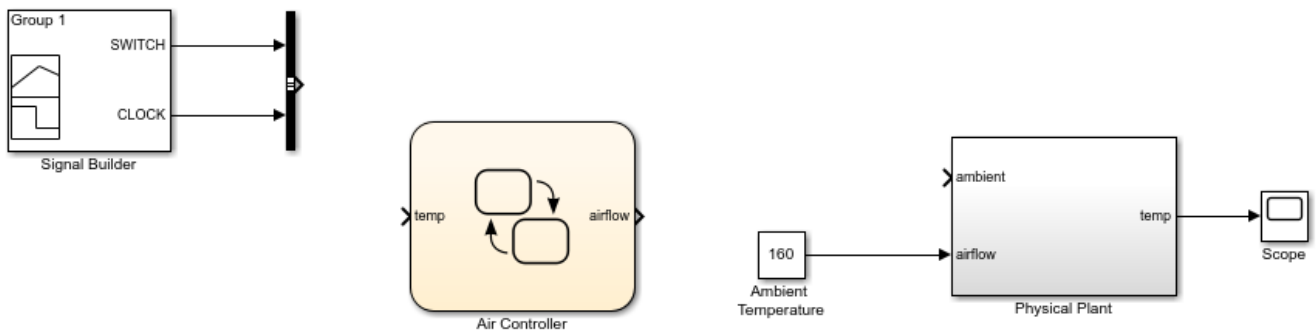

Tip You might need to enlarge the Air Controller block to see the input and output clearly. To change the size of the block:

- a Select the block and move your pointer over one of the corners until it changes to this shape:



- b Hold down the left mouse button and drag the block to the desired size.

- 5 Save Stage1Interface.

Tip There are several ways to add data objects to Stateflow charts. You used the Stateflow Editor, which lets you add data elements to the Stateflow chart that is open and has focus. However, to add data objects not just to a chart, but anywhere in the Stateflow design hierarchy, you can use a tool called the Model Explorer. This tool also lets you view and modify the data objects you have already added to a chart. For more information, see “Overview of Stateflow Objects” on page 2-2 and “Add Data Through the Model Explorer” on page 9-3 in the Stateflow User's Guide. You can also add data objects programmatically using the Stateflow API, as described in “Create Stateflow Objects” in the Stateflow API Guide.

Connecting the Stateflow Block to the Simulink Subsystem

Now that you have defined the inputs and outputs for the Stateflow Air Controller block, you need to connect them to the corresponding signals of the Simulink Physical Plant subsystem. Follow these steps:

- 1 In the model Stage1Interface, connect the output `airflow` from Air Controller to the corresponding input in Physical Plant:
 - a Place your pointer over the output port for `airflow` on the right side of the Air Controller block.

The pointer changes in shape to crosshairs.

 - b Hold down the left mouse button and move the pointer to the input port for `airflow` on the left side of the Physical Plant block.
 - c Release the mouse.

The connection should look something like this:

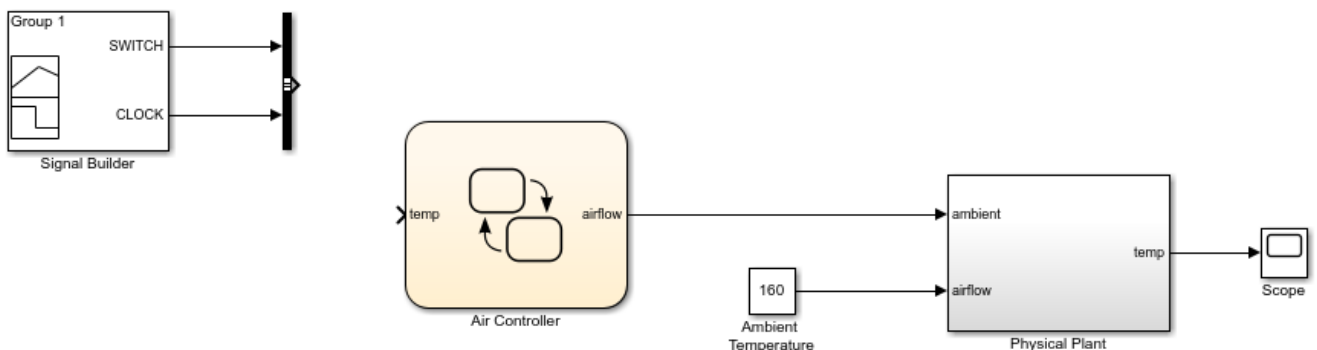

Tip You can use a shortcut for automatically connecting blocks. Select the source block, and then hold down the **Ctrl** key and left-click the destination block.

- 2 Connect the output `temp` from the Physical Plant to the corresponding input in Air Controller by drawing a branch line from the line that connects `temp` to the Scope:
 - a Place your pointer on the line where you want the branch line to start.
 - b While holding down the **Ctrl** key, press and hold down the left mouse button.
 - c Drag your pointer to the input port for `temp` on the left side of the Air Controller block.
 - d Release the mouse button and the **Ctrl** key.
 - e Reposition the connection so that it looks like this:

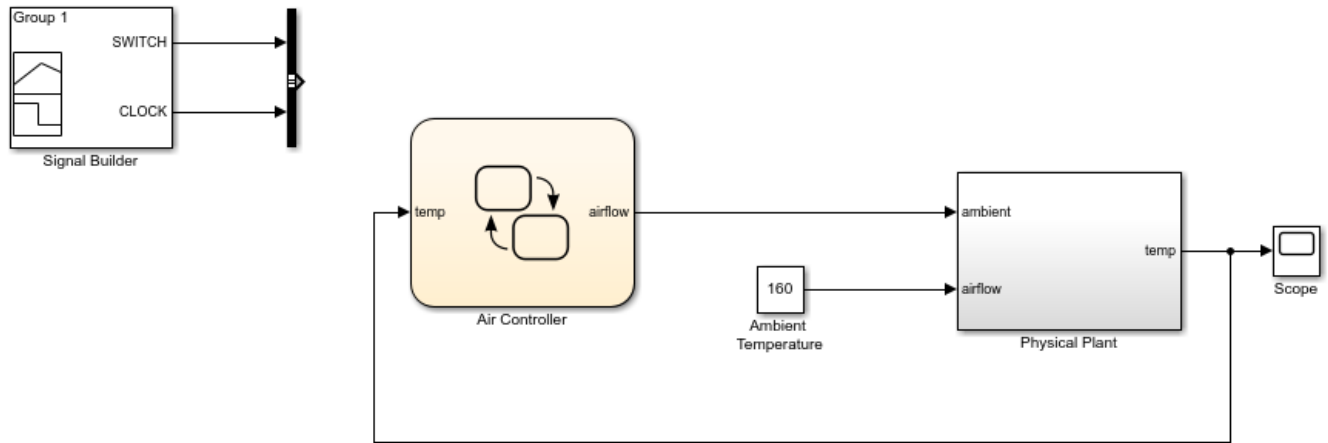

Tip To reposition connections, move your cursor over the end of the line. When the cursor changes to a circle, select the end of the line with the left mouse button and drag the line to a new location.

3 Save Stage1Interface.

Where to go next. Now you are ready to model the operating modes with states. See “Implementing the States to Represent Operating Modes” on page 1-23.

Implementing the States to Represent Operating Modes

In phase 2 of this workflow, you *define the states for modeling each mode of operation*.

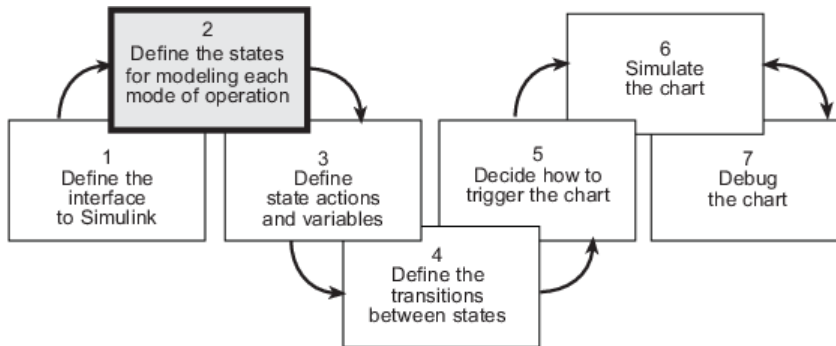

Build It Yourself or Use the Supplied Model

To implement the states yourself, work through the exercises in this section. Otherwise, open the supplied model by entering this command at the MATLAB prompt:

```
addpath(fullfile(docroot, 'toolbox', 'stateflow', 'gs', 'examples'))
Stage2States
```

Design Considerations for Defining the States

The following sections describe the rationale for the hierarchy and decomposition of states in the chart.

When to Use States

Whether or not to use states depends on the control logic you want to implement. You can model two types of control logic: *finite state machines* and *stateless flow charts*. Each type is optimized for different applications, as follows:

Control Logic	Optimized for Modeling
Finite state machines	Physical systems that transition between a finite number of operating modes. In Stateflow charts, you represent each mode as a state.
Stateless flow charts	Abstract logic patterns — such as <code>if</code> , <code>if-else</code> , and <code>case</code> statements — and iterative loops — such as <code>for</code> , <code>while</code> , and <code>do</code> loops. You represent these logic constructs with connective junctions and transitions in Stateflow charts. No states are required.

The Air Controller chart is a system that cools a physical plant by transitioning between several modes of operation and, therefore, can be modeled as a finite state machine. In the following sections, you will design the states that model each mode of operation.

Determining the States to Define

States model modes of operation in a physical system. To determine the number and type of states required for your Air Controller chart, you must identify each mode in which the system can operate. Often, a table or grid is helpful for analyzing each mode and determining dependencies between modes.

Analysis of Operating Modes

For Air Controller, the modes of operation are

Operating Mode	Description	Dependencies
Power Off	Turns off all power in the control system	No fan can operate when power is off.
Power On	Turns on all power in the control system	Zero, one, or two fans can operate when power is on.
Fan 1	Activates Fan 1	Fan 1 can be active at the same time as Fan 2. When activated, Fan 1 can turn on or off.
Fan 1 On	Cycles on Fan 1	Fan 1 On can be active if Fan 1 is active and power is on.
Fan 1 Off	Cycles off Fan 1	Fan 1 Off can be active if Fan 1 is active, and power is on.
Fan 2	Activates Fan 2	Fan 2 can be active at the same time as Fan 1. When activated, Fan 2 can turn on or off.
Fan 2 On	Cycles on Fan 2	Fan 2 On can be active if Fan 2 is active and power is on.
Fan 2 Off	Cycles off Fan 2	Fan 2 Off can be active if Fan 2 is active and power is on.
Calculate airflow	Calculates a constant value of 0, 1, or 2 to indicate how fast air is flowing. Outputs this value to the Simulink subsystem for selecting a cooling factor.	Calculates the constant value, based on how many fans have cycled on at each time step.

Number of States to Define

The number of states depends on the number of operating modes to be represented. In “Analysis of Operating Modes” on page 1-24, you learned that the Air Controller chart has nine operating modes. Therefore, you need to define nine states to model each mode. Here are the names you will assign to the states that represent each operating mode in “Implementing the States to Represent Operating Modes” on page 1-23:

State Name	Operating Mode
PowerOff	Power Off
PowerOn	Power On
FAN1	Fan 1
FAN2	Fan 2
SpeedValue	Calculate airflow
FAN1.On	Fan 1 On
FAN1.Off	Fan 1 Off
FAN2.On	Fan 2 On

State Name	Operating Mode
FAN2.Off	Fan 2 Off

Note Notice the use of dot notation to refer to the On and Off states for FAN1 and FAN2. You use namespace dot notation to give objects unique identifiers when they have the same name in different parts of the chart hierarchy.

Determining the Hierarchy of States

Stateflow objects can exist in a hierarchy. For example, states can *contain* other states — referred to as *substates* — and, in turn, can be *contained* by other states — referred to as *superstates*. You need to determine the hierarchical structure of states you will define for the Air Controller chart. Often, dependencies among states imply a hierarchical relationship — such as parent to child — between the states.

Based on the dependencies described in “Analysis of Operating Modes” on page 1-24, here is an analysis of state hierarchy for the Air Controller chart:

Dependent States	Implied Hierarchy
FAN1 and FAN2 depend on PowerOn. No fan can operate unless PowerOn is active.	FAN1 and FAN2 should be substates of a PowerOn state.
FAN1.On and FAN1.Off depend on Fan1 and PowerOn. FAN1 must be active before it can be cycled on or off.	FAN1 should have two substates, On and Off. In this hierarchical relationship, On and Off will inherit from FAN1 the dependency on PowerOn.
FAN2.On and FAN2.Off depend on FAN2 and PowerOn. FAN2 must be active before it can be cycled on or off.	FAN2 should have two substates, On and Off. In this hierarchical relationship, On and Off will inherit from FAN2 the dependency on PowerOn.
The state that calculates airflow needs to know how many fans are running at each time step.	The state that calculates airflow should be a substate of PowerOn so it can check the status of FAN1 and FAN2 at the same level of hierarchy.

Determining the Decomposition of States

The *decomposition* of a state dictates whether its substates execute exclusively of each other — as *exclusive (OR) states* — or can be activated at the same time — as *parallel (AND) states*. No two exclusive (OR) states can ever be active at the same time, while any number of parallel (AND) states can be activated concurrently.

The Air Controller chart requires both types of states. Here is a breakdown of the exclusive (OR) and parallel (AND) states required for the Stateflow chart:

State	Decomposition	Rationale
PowerOff, PowerOn	Exclusive (OR) states	The power can never be on and off at the same time.
FAN1, FAN2	Parallel (AND) states	Zero, one, or two fans can operate at the same time, depending on how much cooling is required.
FAN1.On, FAN1.Off	Exclusive (OR) states	Fan 1 can never be on and off at the same time.
FAN2.On, FAN2.Off	Exclusive (OR) states	Fan 2 can never be on and off at the same time.

State	Decomposition	Rationale
SpeedValue	Parallel (AND) state	SpeedValue is an observer state that monitors the status of Fan 1 and Fan 2, updating its output based on how many fans are operating at each time step. SpeedValue must be activated at the same time as Fan 1 and Fan 2, but execute last so it can capture the most current status of the fans.

Adding the Power On and Power Off States

When you add states to the Air Controller chart, you will work from the top down in the Stateflow hierarchy. As you learned in “Determining the Decomposition of States” on page 1-25, the **PowerOff** and **PowerOn** states are exclusive (OR) states that turn power off and on in the control system. These states are never active at the same time. By default, states are exclusive (OR) states, represented graphically as rectangles with solid borders.

To add **PowerOn** and **PowerOff** to your chart, follow these steps:

- 1 Open the model **Stage1Interface** — either the one you created in the previous exercise or the supplied model for stage 1.

To open the supplied model, enter the following command at the MATLAB prompt:

```
addpath(fullfile(docroot, 'toolbox', 'stateflow', 'gs', 'examples'))
Stage1Interface
```

- 2 Save the model as **Stage2States** in your local work folder.
- 3 In **Stage2States**, double-click the **Air Controller** block to open the Stateflow chart.

The Stateflow Editor for **Air Controller** opens on your desktop. Notice the object palette on the left side of the editor window. This palette displays a set of tools for drawing graphical chart objects, including states:

- 4 Left-click the state tool icon:



- 5 Move your pointer into the drawing area.

The pointer changes to a rectangle, the graphical representation of a state.

- 6 Click in the upper-left corner of the drawing area to place the state.

The new state appears with a blinking text cursor in its upper-left corner.

- 7 At the text cursor, type **PowerOn** to name the state.

Tip If you click away from the text cursor before typing the new name, the cursor changes to a question mark. Click the question mark to restore the text cursor.

- 8 Move your pointer to the lower-right corner of the rectangle so it changes to this symbol:



- 9 Drag the lower-right corner to enlarge the state as shown:



- 10** Click the state tool icon again and draw a smaller state named `PowerOff` at the bottom of the drawing area, like this:

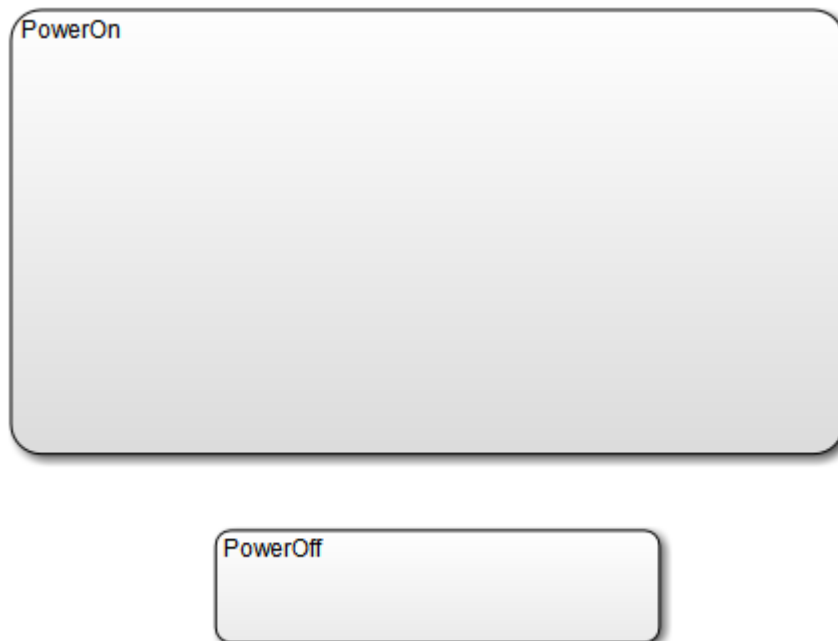

- 11** Save the chart by clicking **Save** in the **Simulation** tab, but leave the chart open for the next exercise.

Adding and Configuring Parallel States

In “Determining the States to Define” on page 1-23, you learned that `FAN1`, `FAN2`, and `SpeedValue` will be represented by parallel (AND) substates of the `PowerOn` state. Parallel states appear graphically as rectangles with dashed borders.

In this set of exercises, you will learn how to:

- Assign parallel decomposition to `PowerOn` so its substates can be activated concurrently.

Recall that the decomposition of a state determines whether its substates will be exclusive or parallel.

- Add parallel substates to a state in the chart.
- Set the order of execution for the parallel substates.

Even though parallel states can be activated concurrently, they execute in a sequential order.

Setting Parallel Decomposition

Follow these steps:

- 1 In the Air Controller chart, right-click inside `PowerOn`.

A submenu opens, presenting tasks you can perform and properties you can set for the selected state.

- 2 In the submenu, select **Decomposition > AND (Parallel)**.
- 3 Save the model `Stage2States`, but leave the chart open for the next exercise.

Adding the Fan States

Follow these steps:

- 1 Left-click the state tool icon in the Stateflow Editor and place two states inside the `PowerOn` state.

Tip Instead of using the state tool icon to add multiple states, you can right-click inside an existing state and drag a copy to a new position in the chart. This shortcut is convenient when you need to create states of the same size and shape, such as the fan states.

- 2 Notice the appearance of the states you just added.

The borders of the two states appear as dashed lines, indicating that they are parallel states. Note also that the substates display numbers in their upper-right corners. These numbers specify the order of execution. Although multiple parallel (AND) states in the same chart are activated concurrently, the chart must determine when to execute each one during simulation.

- 3 Name the new substates `FAN1` and `FAN2`.

You have created hierarchy in the Air Controller chart. `PowerOn` is now a superstate while `FAN1` and `FAN2` are substates. Your chart should look something like this:

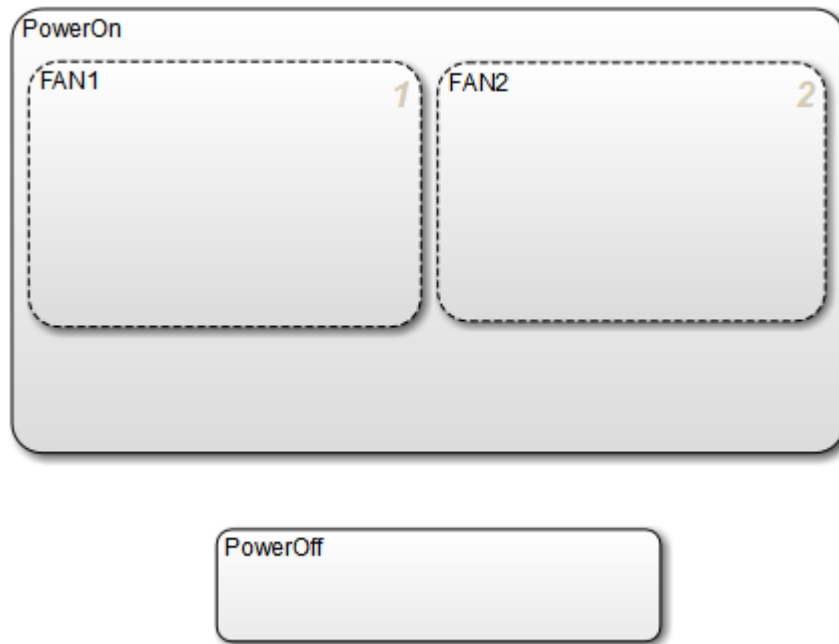

Note Your chart might not show the same execution order for parallel substates FAN1 and FAN2. The reason is that, by default, Stateflow software orders parallel states based on order of creation. If you add FAN2 before FAN1 in your chart, FAN2 moves to the top of the order. You will fine-tune order of activation in a later exercise, “Setting Explicit Ordering of Parallel States” on page 1-30.

Tip If you want to move a state together with its substates — and any other graphical objects it contains — double-click the state. It turns gray, indicating that the state is grouped with the objects inside it and that they can be moved as a unit. To ungroup the objects, double-click the state again.

- 4 Save the model Stage2States, but leave the chart open for the next exercise.

Adding the SpeedValue State

Recall that SpeedValue acts as an observer state, which monitors the status of the FAN1 and FAN2 states. To add the SpeedValue state, follow these steps:

- 1 Add another substate to PowerOn under FAN1 and FAN2, either by using the state tool icon or copying an existing state in the chart.

You might need to resize the substate to prevent overlap with other substates, but remain within the borders of PowerOn.

- 2 Name the state SpeedValue.

Like FAN1 and FAN2, SpeedValue appears as a parallel substate because its parent, the superstate PowerOn, has parallel decomposition.

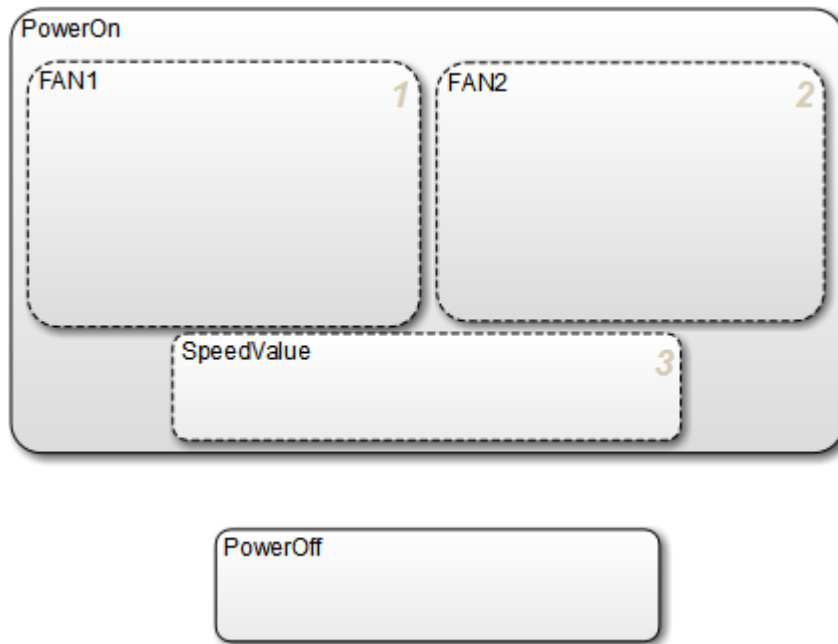

- 3 Save the model Stage2States, but leave the chart open for the next exercise, “Setting Explicit Ordering of Parallel States” on page 1-30.

Setting Explicit Ordering of Parallel States

Recall that, by default, Stateflow software assigns execution order of parallel states based on order of creation in the chart. This behavior is called *explicit ordering*. In this exercise, you will set the execution order explicitly for each parallel state in your chart.

- 1 In the Stateflow Editor, in the **Modeling** tab, select **Chart Properties**.
- 2 In the Chart properties dialog box, verify that the check box **User-specified state/transition execution order** is selected and click **OK**.

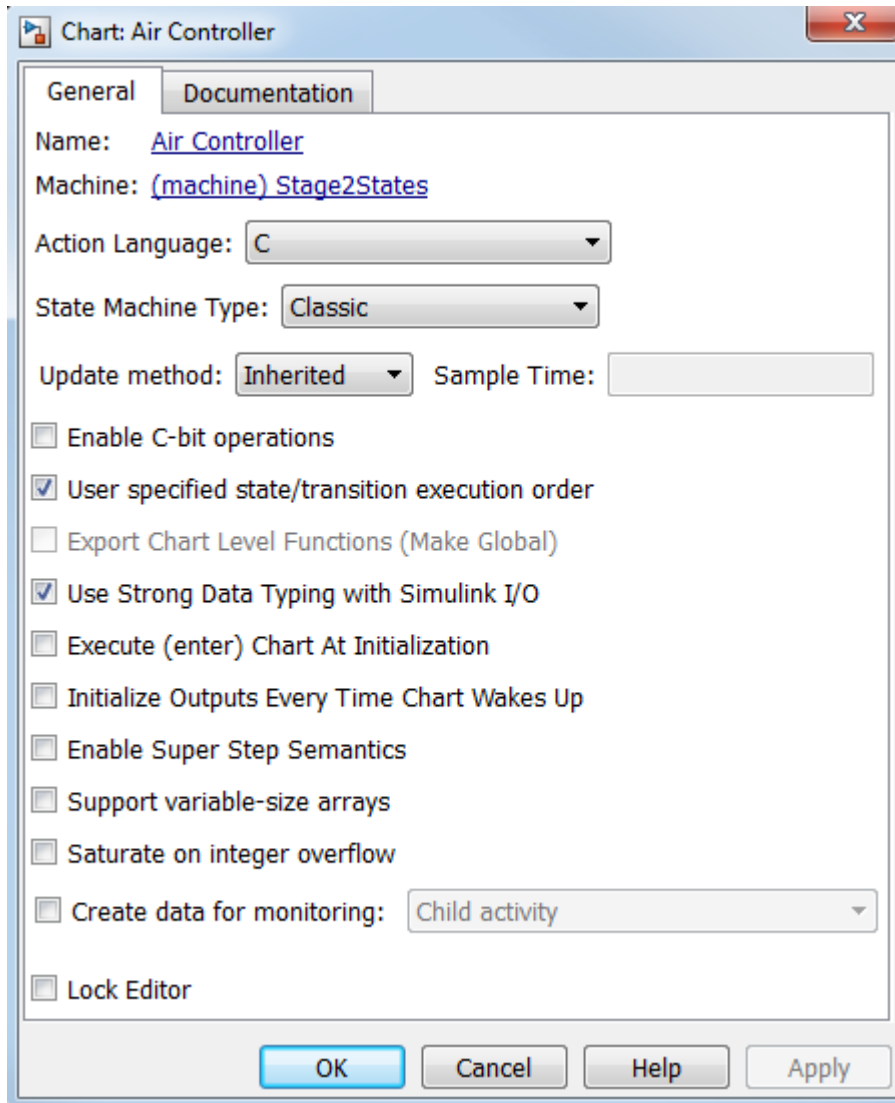

Note This option also lets you explicitly specify the order in which transitions execute when there is a choice of transitions to take from one state to another. This behavior does not apply to the Air Controller chart because it is deterministic: for each exclusive (OR) state, there is one and only one transition to a next exclusive (OR) state. You will learn more about transitions in “Drawing the Transitions Between States” on page 1-34.

- 3 Assign order of execution for each parallel state in the Air Controller chart:
 - a Right-click inside each parallel state to bring up its state properties submenu.
 - b From the submenu, select **Execution Order** and make these assignments:

For State:	Assign:
FAN1	1
FAN2	2

For State:	Assign:
SpeedValue	3

Here is the rationale for this order of execution:

- FAN1 should execute first because it cycles on at a lower temperature than FAN2.
 - SpeedValue should execute last so it can observe the most current status of FAN1 and FAN2.
- 4 Save the model Stage2States, but leave the chart open for the next exercise, “Adding the On and Off States for the Fans” on page 1-32.

Adding the On and Off States for the Fans

In this exercise, you will enter the on and off substates for each fan. Because fans cannot cycle on and off at the same time, these states must be exclusive, not parallel. Even though FAN1 and FAN2 are parallel states, their *decomposition* is exclusive (OR) by default. As a result, any substate that you add to FAN1 or FAN2 will be an exclusive (OR) state.

Follow these steps:

- 1 Add two substates inside FAN1 and FAN2.
- 2 Resize the substates to fit within the borders of FAN1 and FAN2.
- 3 In each fan state, name one substate On and name the other Off.

Your Air Controller chart should now look something like this:

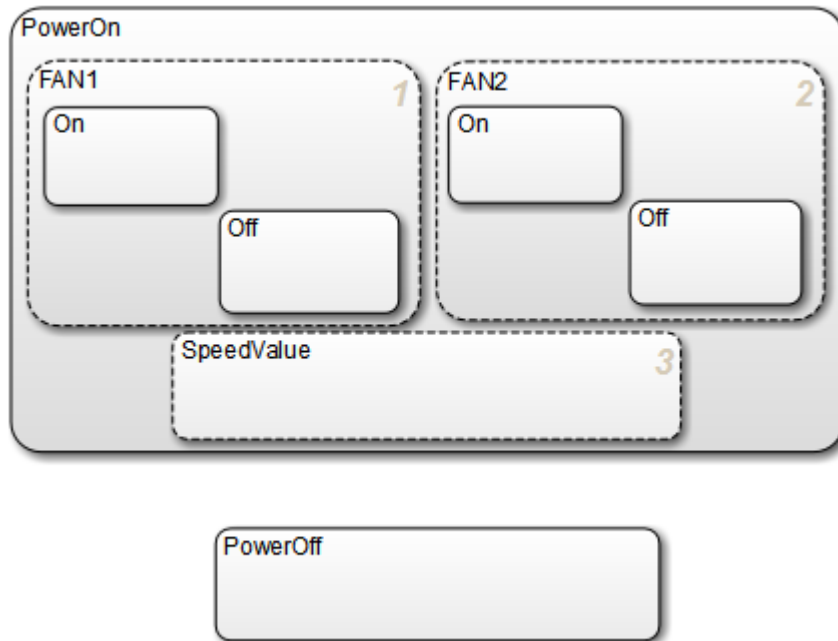

- 4 Save the model Stage2States.

Where to go next. Now you are ready to specify the actions that execute when a state is active.

Adding the Transitions

In phase 4 of this workflow, you *define the transitions between states*.

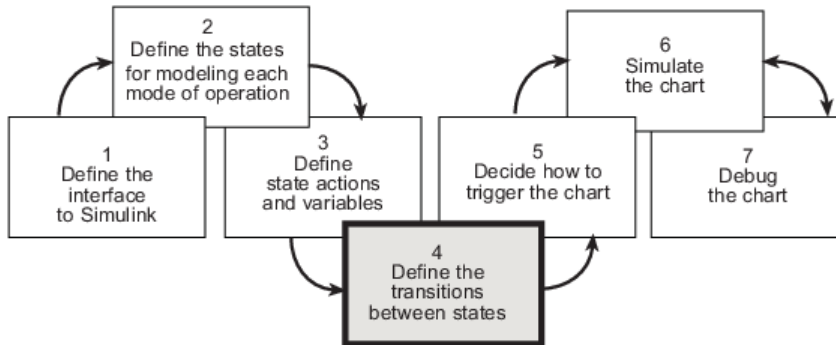

Build It Yourself or Use the Supplied Model

To add the transitions yourself, work through the exercises in this section. Otherwise, open the supplied model to see how the transitions should appear in the chart. Enter this command at the MATLAB prompt:

```
addpath(fullfile(docroot, 'toolbox', 'stateflow', 'gs', 'examples'))
Stage4Transitions
```

Design Considerations for Defining Transitions Between States

The following sections describe the decisions you make for defining state transitions.

Deciding How and When to Transition Between Operating Modes

Transitions create paths for the logic flow of a system from one state to another. When a transition is taken from state A to state B, state A becomes inactive and state B becomes active.

Transitions have direction and are represented in a Stateflow chart by lines with arrowheads. Transitions are unidirectional, not bidirectional. You must add a transition for each direction of flow between two states.

Exclusive (OR) states require transitions. Recall that no two exclusive states can be active at the same time. Therefore, you need to add transitions to specify when and where control flows from one exclusive state to another.

Typically, parallel (AND) states do not require transitions because they execute concurrently.

The Air Controller chart models a system in which power can cycle on and off and, while power is on, fans can cycle on and off. Six exclusive (OR) states represent these operating modes. To model this activity, you need to add the following transitions between exclusive (OR) states:

- PowerOff to PowerOn
- PowerOn to PowerOff
- FAN1.Off to FAN1.On
- FAN1.On to FAN1.Off

- FAN2.Off to FAN2.On
- FAN2.On to FAN2.Off

Deciding Where to Place Default Transitions

Good design practice requires that you specify default transitions for exclusive (OR) states at each level of hierarchy. *Default transitions* indicate which exclusive (OR) state is to be active when there is ambiguity between two or more exclusive (OR) states at the same level in the Stateflow hierarchy. There are three such areas of ambiguity in the Air Controller chart:

- When the chart wakes up, should power be on or off?
- When FAN1 becomes active, should it be on or off?
- When FAN2 becomes active, should it be on or off?

In each case, the initial state should be off so you will add default transitions to the states PowerOff, FAN1.Off, and FAN2.Off.

Deciding How to Guard the Transitions

Guarding a transition means specifying a condition, action, or event that allows the transition to be taken from one state to another. Based on the design of the Air Controller chart, here are the requirements for guarding the transitions from one exclusive operating mode to another:

Transition	When Should It Occur?	How to Guard It
PowerOff to PowerOn	At regular time intervals	Specify an edge-triggered event
PowerOn to PowerOff		
FAN1.Off to FAN1.On	When the temperature of the physical plant rises above 120 degrees	Specify a condition based on temperature value
FAN1.On to FAN1.Off	When the temperature of the physical plant falls below 120 degrees	
FAN2.Off to FAN2.On	When the temperature rises above 150 degrees, a threshold indicating that first fan is not providing the required amount of cooling	
FAN2.On to FAN2.Off	When the temperature falls below 150 degrees	

Drawing the Transitions Between States

In “Design Considerations for Defining Transitions Between States” on page 1-33, you learned that the following transitions occur in the Air Controller chart:

- Power for the control system can cycle on and off.
- Each fan can cycle on and off.

You will model this activity by drawing transitions between the PowerOn and PowerOff states and between the On and Off states for each fan. Follow these steps:

- 1 Open the model `Stage3Actions` — either the one you created in the previous exercises or the supplied model for stage 3.

To open the supplied model, enter the following command at the MATLAB prompt:

```
addpath(fullfile(docroot, 'toolbox', 'stateflow', 'gs', 'examples'))
Stage3Actions
```

- 2 Save the model as `Stage4Transitions` in your local work folder.
- 3 In `Stage4Transitions`, double-click the Air Controller block to open the Stateflow chart.

The chart opens on your desktop.

- 4 Draw transitions between the `PowerOff` to `PowerOn` states:
 - a Move your pointer over the top edge of `PowerOff` until the pointer shape changes to crosshairs.
 - b Hold down the left mouse button, drag your pointer to the bottom edge of `PowerOn`, and release the mouse.

You should see a transition pointing from `PowerOff` to `PowerOn`:

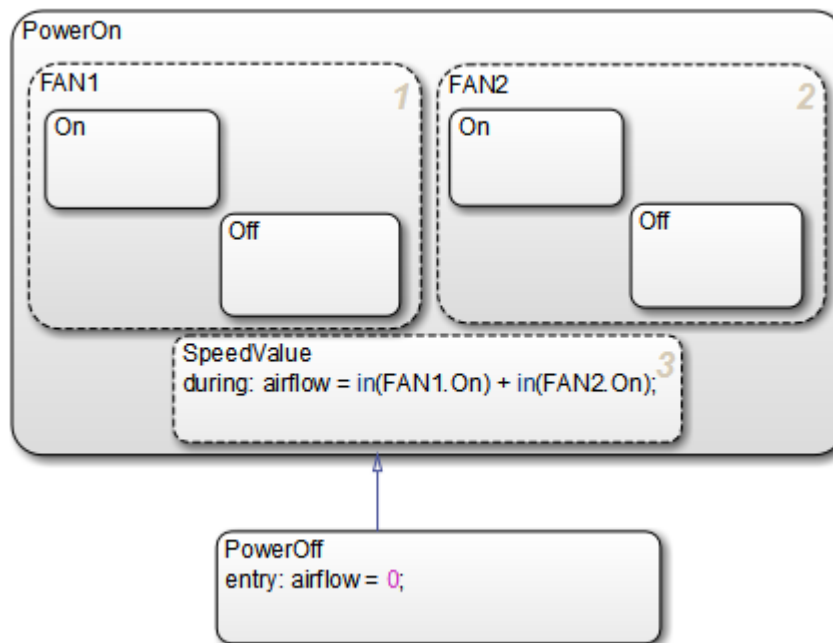

- c Follow the same procedure to draw a transition from `PowerOn` to `PowerOff`.

Your chart should now look like this:

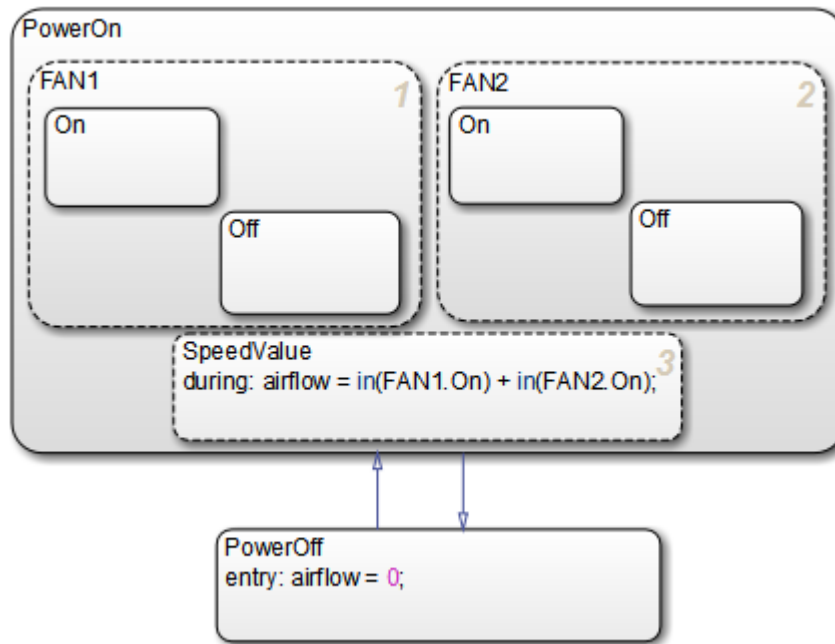

5 Follow the procedure described in step 3 to draw the following transitions between the Off and On states for each fan:

- Transition from Off to On in FAN1
- Transition from On to Off in FAN1
- Transition from Off to On in FAN2
- Transition from On to Off in FAN2

Your chart should now look like this:

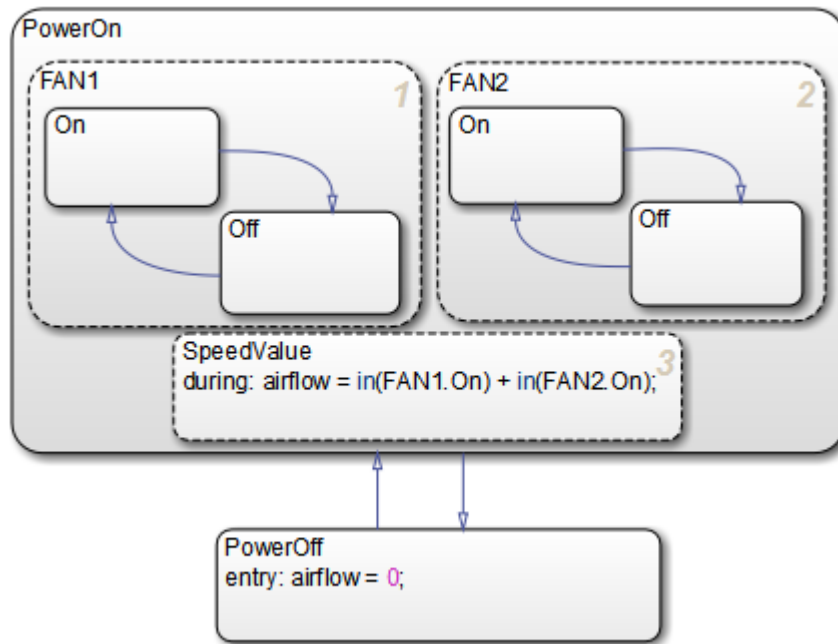

- 6 Save Stage4Transitions, but leave the chart open for the next exercise.

Adding Default Transitions

In “Deciding Where to Place Default Transitions” on page 1-34, you learned that you need to add default transitions to `PowerOff`, `FAN1.Off`, and `FAN2.Off`. Follow these steps:

- 1 In the Stateflow Editor, left-click the default transition icon in the object palette:



- 2 Move your pointer into the drawing area.

The pointer changes to a diagonal arrow.

- 3 Place your pointer at the left edge of the `PowerOff` state.

- 4 When the arrow becomes orthogonal to the edge, release the mouse button.

The default transition attaches to the `PowerOff` state. It appears as a directed line with an arrow at its head and a closed tail:

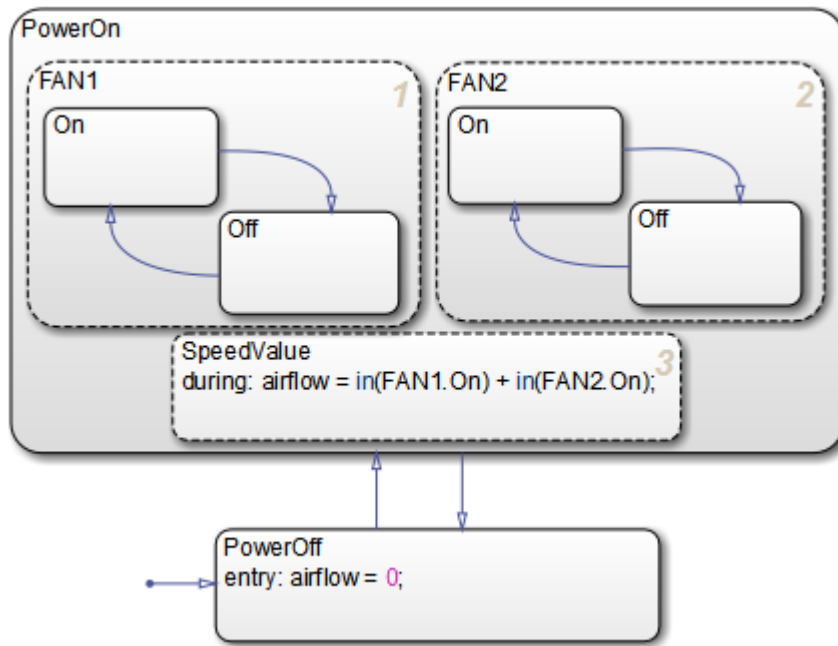

- Repeat the same procedure to add default transitions at the top edges of **FAN1.Off** and **FAN2.Off**.

Your chart should now look like this:

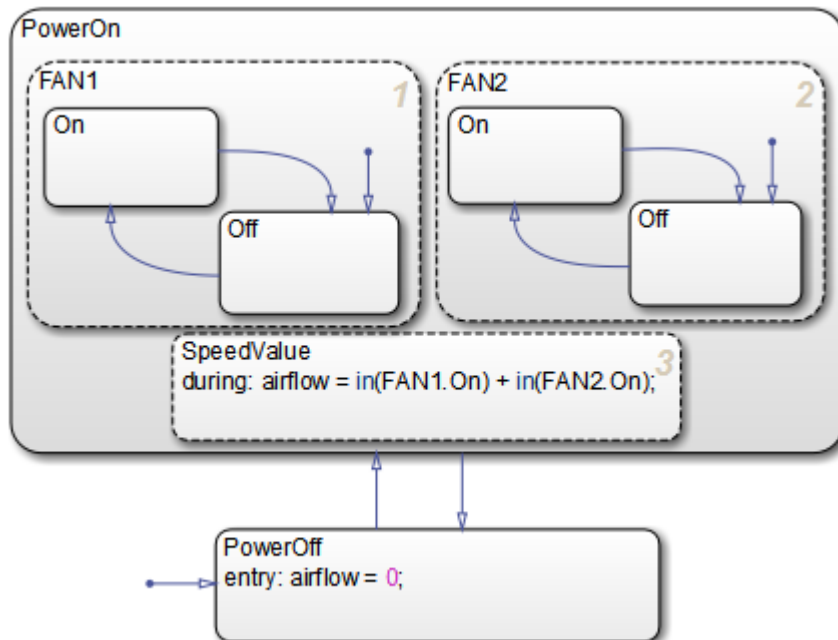

Tip The location of the tail of a default transition determines the state it activates. Therefore, make sure that your default transition fits completely inside the parent of the state that it

activates. In the Air Controller chart pictured above, notice that the default transition for `FAN1.Off` correctly resides inside the parent state, `FAN1`. Now consider this chart:

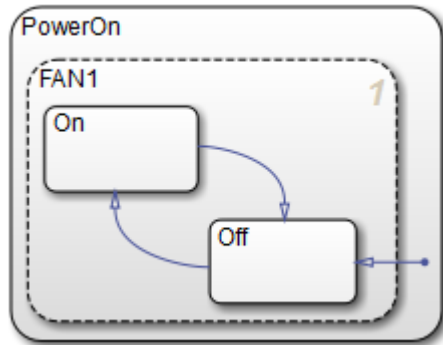

In this example, the tail of the default transition resides in `PowerOn`, not in `FAN1`. Therefore, it will activate `FAN1` instead of `FAN1.Off`.

- 6 Save `Stage4Transitions`, but leave the chart open for the next exercise.

Adding Conditions to Guard Transitions

Conditions are expressions enclosed in square brackets that evaluate to true or false. When the condition is true, the transition is taken to the destination state; when the condition is false, the transition is not taken and the state of origin remains active.

As you learned in “Deciding How to Guard the Transitions” on page 1-34, the fans cycle on and off depending on the air temperature. In this exercise, you will add conditions to the transitions in `FAN1` and `FAN2` that model this behavior.

Follow these steps:

- 1 Click the transition from `FAN1.Off` to `FAN1.On`.

The transition appears highlighted and displays a question mark (?).

- 2 Click next to the question mark to display a blinking text cursor.
- 3 Type the following expression:

```
[temp >= 120]
```

You may need to reposition the condition for readability. Click outside the condition, then left-click and drag the condition expression to a new location.

- 4 Repeat these steps to add the following conditions to the other transitions in `FAN1` and `FAN2`:

Transition	Condition
<code>FAN1.On</code> to <code>FAN1.Off</code>	<code>[temp < 120]</code>
<code>FAN2.Off</code> to <code>FAN2.On</code>	<code>[temp >= 150]</code>
<code>FAN2.On</code> to <code>FAN2.Off</code>	<code>[temp < 150]</code>

Your chart should look like this:

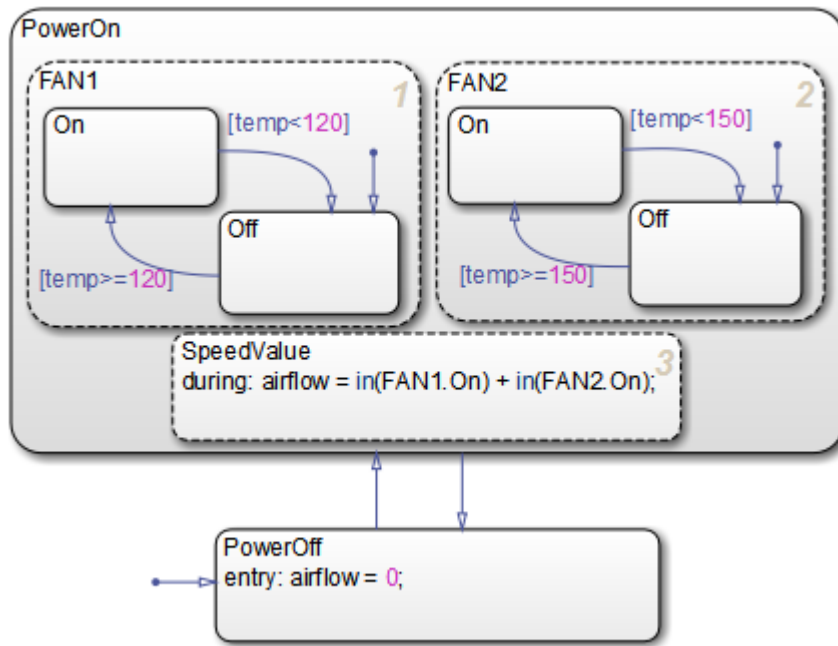

- 5 Save Stage4Transitions, but leave the chart open for the next exercise.

Adding Events to Guard Transitions

Events are nongraphical objects that trigger activities during the execution of a Stateflow chart. Depending on where and how you define events, they can trigger a transition to occur, an action to be executed, and state status to be evaluated. In this exercise, you will define an event that triggers transitions.

As you learned in “Deciding How to Guard the Transitions” on page 1-34, the control system should power on and off at regular intervals. You model this behavior by first defining an event that occurs at the rising or falling edge of an input signal, and then associating that event with the transitions between the **PowerOn** and **PowerOff** states.

Follow these steps to define an edge-triggered event and associate it with the transitions:

- 1 From the Stateflow Editor, in the **Modeling** tab, under **Design Data**, click **Event Input**.

The Event properties dialog box opens on your desktop:

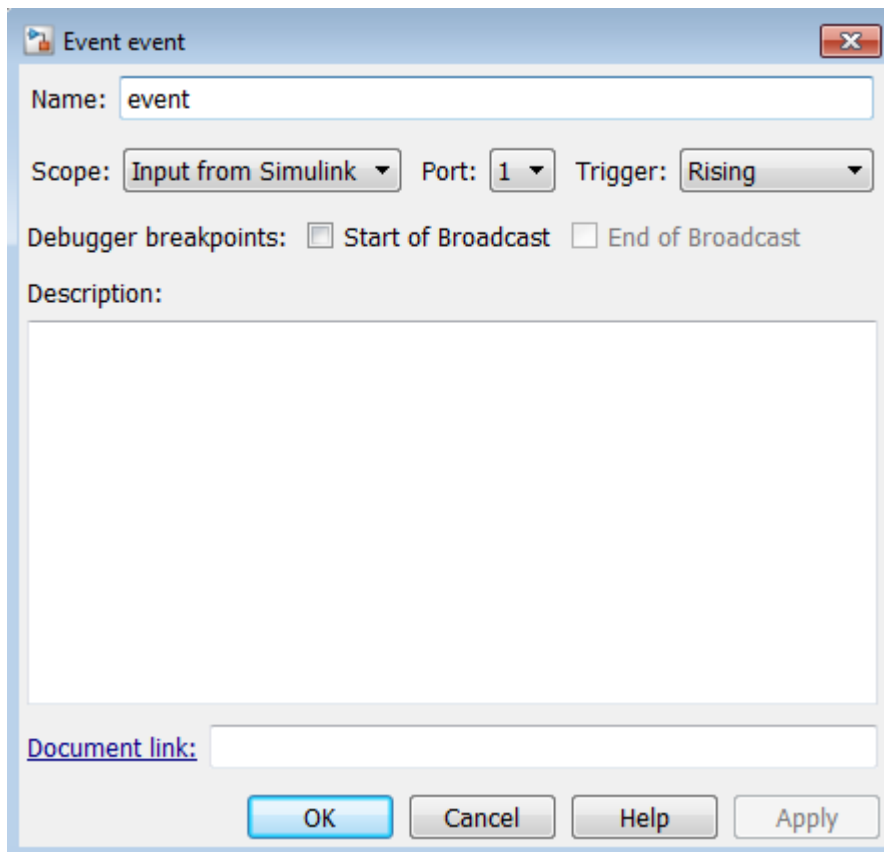

Note that the event is assigned to trigger port 1.

- 2 Edit the following properties:

Property	What to Specify
Name	Change the name to SWITCH.
Trigger	Select Either from the drop-down menu so the event can be triggered by either the rising edge or falling edge of a signal.

- 3 Click **OK** to record the changes and close the dialog box.
- 4 Look back at the model and notice that a trigger port appears at the top of the Stateflow block:

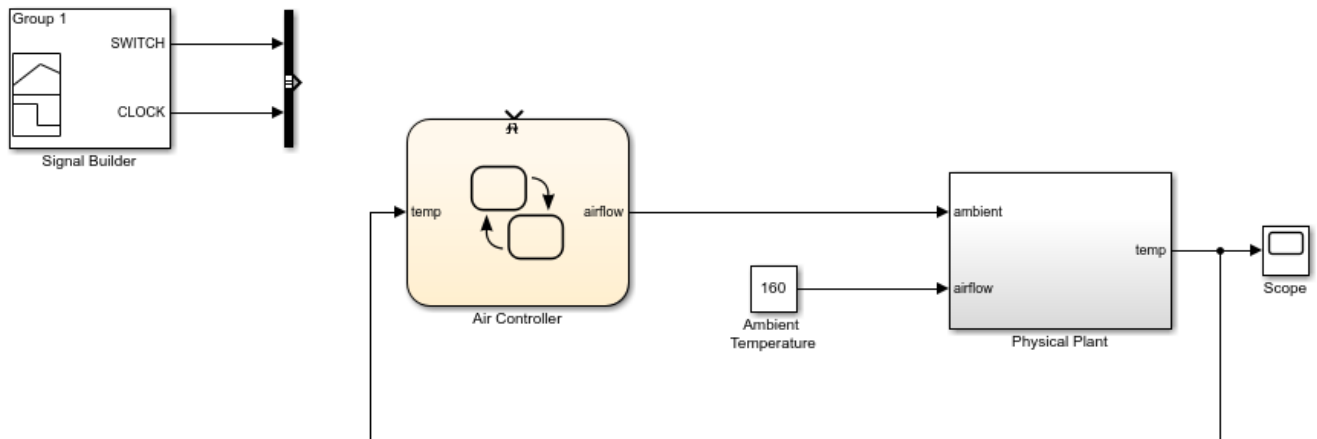

When you define one or more input events for a chart, Stateflow software adds a single trigger port to the block. External Simulink blocks can trigger the input events via a signal or vector of signals connected to the trigger port.

- 5** Back in the Stateflow Editor, associate the input event **SWITCH** with the transitions:
 - a** Select the transition from **PowerOff** to **PowerOn** and click the question mark to get a text cursor.
 - b** Type the name of the event you just defined, **SWITCH**.

You might need to reposition the event text for readability. If so, click outside the text, left-click the text, and drag it to the desired location.

- c** Repeat these steps to add the same event, **SWITCH**, to the transition from **PowerOn** to **PowerOff**.

Your chart should now look something like this:

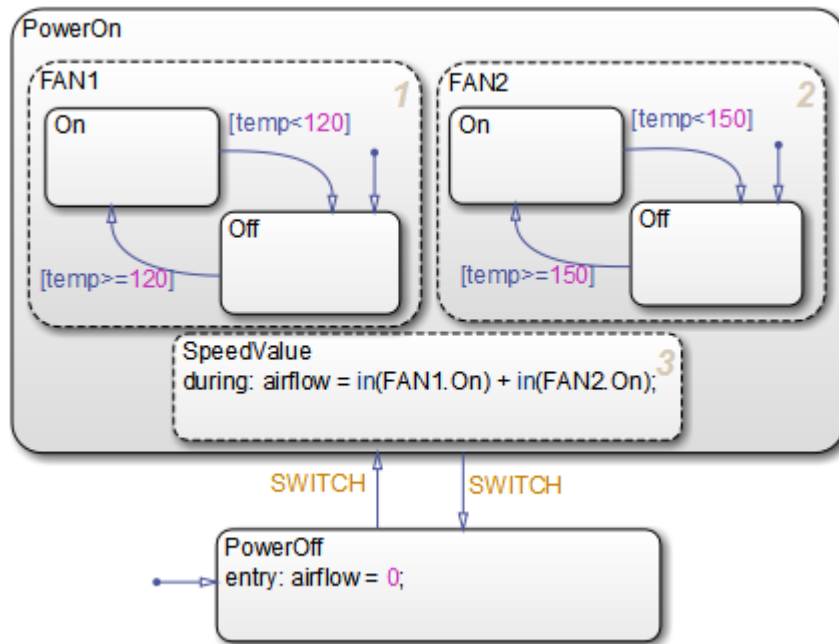

Now that you have associated these transitions with the event `SWITCH`, the control system will alternately power on and off every time `SWITCH` occurs — that is, every time the chart detects a rising or falling signal edge.

Note that the `sf_aircontrol` model has already defined the pulse signal `SWITCH` in the Signal Builder block at the top level of the model hierarchy:

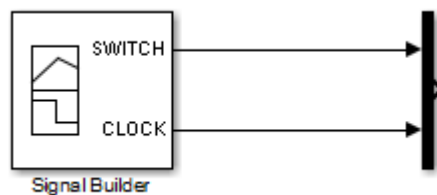

In the next phase of the workflow, you will connect your Stateflow chart to the `SWITCH` signal to trigger the transitions between power on and power off.

6 Save Stage4Transitions.

Where to go next. Now you are ready to implement an edge-triggered event to wake up the chart at regular intervals. See “Implementing the Triggers” on page 1-44.

Implementing the Triggers

In phase 5 of this workflow, you *decide how to trigger the chart*.

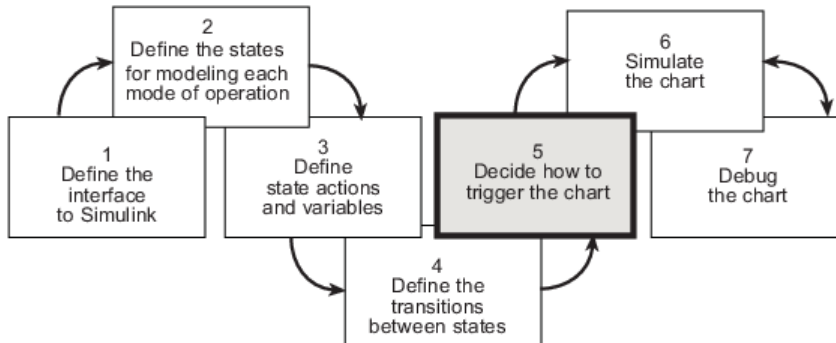

Build It Yourself or Use the Supplied Model

To implement the triggers yourself, work through the exercises in this section. Otherwise, open the supplied model to see how the triggers should appear in the chart. Enter this command at the MATLAB prompt:

```
addpath(fullfile(docroot, 'toolbox', 'stateflow', 'gs', 'examples'))
Stage5Trigger
```

Design Considerations for Triggering Stateflow Charts

A Simulink model can wake up a Stateflow chart by

- Sampling the chart at a specified or inherited rate
- Using a signal as a trigger
- Using one Stateflow chart to drive the activity of another

A signal trigger works best for the Air Controller chart because it needs to monitor the temperature of the physical plant at regular intervals. To meet this requirement, you will use a periodic signal to trigger the chart. The source is a square wave signal called `CLOCK`, provided by a Signal Builder block in the Simulink model, described in “How the Stateflow Chart Works with the Simulink Model” on page 1-7. To harness the signal, you will set up an edge trigger event that wakes the chart at the rising or falling edge of `CLOCK`.

The rationale for using an edge trigger in this case is that it uses the regularity and frequency of the signal to wake up the chart. When using edge triggers, keep in mind that there can be a delay from the time the trigger occurs to the time the chart begins executing. This is because an edge trigger causes the chart to execute at the beginning of the next simulation time step, regardless of when the edge trigger actually occurred during the previous time step. The Air Controller can tolerate this delay, as long as the edge occurs frequently enough. (For more information about triggering Stateflow charts, see “Implement Interfaces to Simulink Models” on page 25-9 in the Stateflow User's Guide.)

Recall that you already defined one edge-triggered event, `SWITCH`, to guard the transitions between `PowerOff` and `PowerOn`. You will now define a second edge-triggered event, `CLOCK`, to wake up the chart.

Defining the CLOCK Event

To define the CLOCK event, follow these steps:

- 1 Open the model `Stage4Transitions` — either the one you created in the previous exercises or the supplied model for stage 4.

To open the supplied model, enter the following command at the MATLAB prompt:

```
addpath(fullfile(docroot, 'toolbox', 'stateflow', 'gs', 'examples'))
Stage4Transitions
```

- 2 Save the model as `Stage5Trigger` in your local work folder.
- 3 In `Stage5Trigger`, double-click the Air Controller block to open the Stateflow chart.
- 4 From the Stateflow Editor, in the **Modeling** tab, under **Design Data**, click **Event Input**.
- 5 In the Event properties dialog box, edit the following fields:

Property	What to Specify
Name	Change the name to <code>CLOCK</code> .
Trigger	Select <code>Either</code> from the drop-down menu so that the rising or falling edge of a signal can trigger the event.

Because the `SWITCH` event you created in “Adding Events to Guard Transitions” on page 1-40 was assigned to trigger port 1, the `CLOCK` event is assigned to trigger port 2. Nevertheless, only one trigger port appears at the top of the Air Controller block to receive trigger signals. This means that each signal must be indexed into an array, as described in “Connecting the Edge-Triggered Events to the Input Signals” on page 1-45.

- 6 Click **OK** to record the changes and close the dialog box.
- 7 Save `Stage5Trigger`, but leave it open for the next exercise.

Connecting the Edge-Triggered Events to the Input Signals

You need to connect the edge-triggered events to the Simulink input signals in a way that

- Associates each event with the correct signal
- Indexes each signal into an array that can be received by the Air Controller trigger port

In `Stage5Trigger`, notice that the two input signals `SWITCH` and `CLOCK` feed into a Mux block where they are joined in an array to a single output. `SWITCH` is a pulse signal and `CLOCK` is a square wave. When you connect the Mux to the trigger port, the index of the signals in the array are associated with the like-numbered ports. Therefore, the `SWITCH` signal at the top input port of the Mux triggers the event `SWITCH` on trigger port 1. Likewise, the `CLOCK` signal at the second input port of the Mux triggers the event `CLOCK` on trigger port 2.

To connect the Mux to the trigger port, follow these steps:

- 1 Click the Mux block, hold down the **Ctrl** key, and click the Air Controller block.

The output signal of the Mux block connects to the input trigger port of the Stateflow block. Your model should look like this:

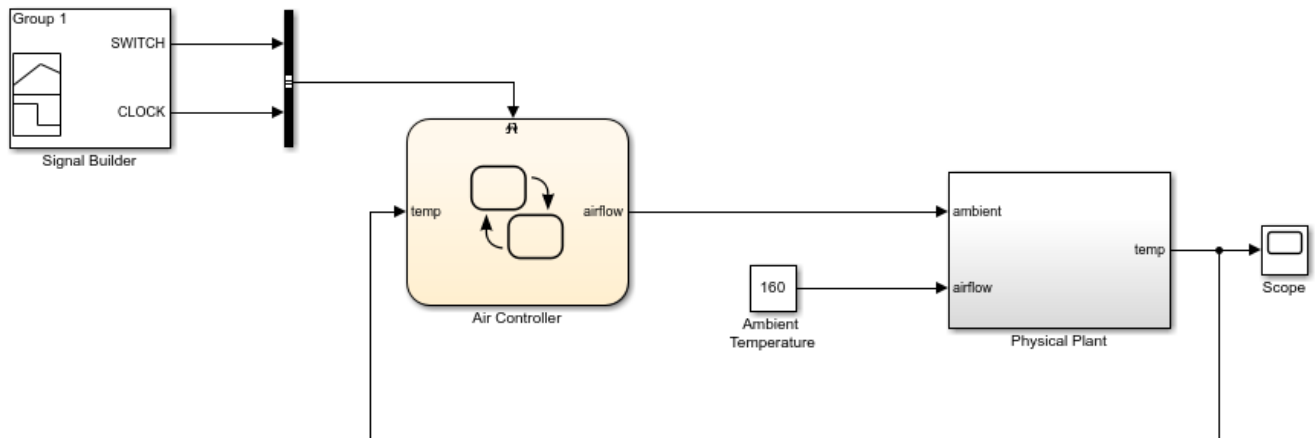

2 Save Stage5Trigger.

Where to go next. Now you are ready to simulate your chart. See “Setting Simulation Parameters and Breakpoints” on page 1-47.

Setting Simulation Parameters and Breakpoints

In phase 6 of this workflow, you *simulate the chart* to test its behavior. During simulation, you can *animate* Stateflow charts to highlight states and transitions as they execute.

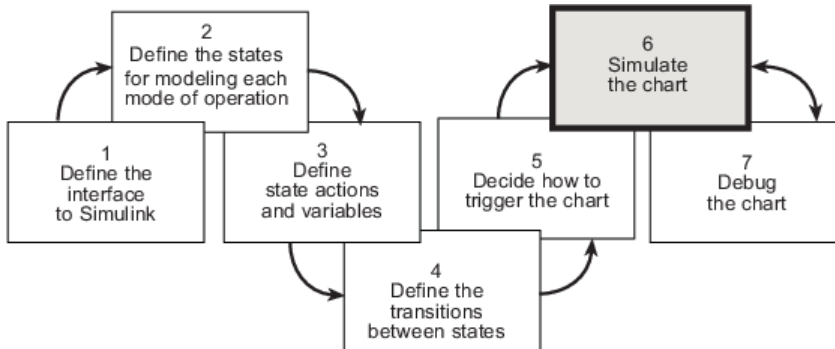

Prepare the Chart Yourself or Use the Supplied Model

To prepare the chart for simulation yourself, work through the exercises in this section. Otherwise, open the supplied model to see how simulation parameters should appear. Enter this command at the MATLAB prompt:

```
addpath(fullfile(docroot, 'toolbox', 'stateflow', 'gs', 'examples'))
Stage6Simulate
```

Checking That Your Chart Conforms to Best Practices

Before starting a simulation session, you should examine your chart to see if it conforms to recommended design practices:

- A default transition must exist at every level of the Stateflow hierarchy that contains exclusive (OR) states (has exclusive [OR] decomposition). (See “Deciding Where to Place Default Transitions” on page 1-34.)
- Whenever possible, input data objects *should* inherit properties from the associated Simulink input signal to ensure consistency, minimize data entry, and simplify maintenance of your model. Recall that in “Defining the Inputs and Outputs” on page 1-16, you defined the input `temp` to inherit its size and type from the Simulink output port `temp`, which provides the input value to the Air Controller chart.
- Output data objects *should not* inherit types and sizes because the values are back propagated from Simulink blocks and may, therefore, be unpredictable. Recall that in “Defining the Inputs and Outputs” on page 1-16, you specified the data type as `uint8` and the size as `scalar` (the default). (See “Avoid Inheriting Output Data Properties from Simulink Blocks” on page 9-3 in the Stateflow User's Guide.)

Tip You can specify data types and sizes as expressions in which you call functions that return property values of other variables already defined in Stateflow, MATLAB, or Simulink software. Such functions include `type` on page 13-17 and `fixdt`. For more information, see “Specify Data Properties by Using MATLAB Expressions” on page 9-16 in the Stateflow User's Guide.

Setting the Length of the Simulation

To specify the length of the simulation, follow these steps:

- 1 Open the model `Stage5Trigger` — either the one you created in the previous exercises or the supplied model for stage 5.

To open the supplied model, enter the following command at the MATLAB prompt:

```
addpath(fullfile(docroot, 'toolbox', 'stateflow', 'gs', 'examples'))  
Stage5Trigger
```

- 2 Save the model as `Stage6Simulate` in your local work folder.
- 3 Double-click `Air Controller` to open the chart.
- 4 Check the settings for simulation time:
 - a In the Simulink Editor, in the **Modeling** tab, click **Model Settings**.

The following dialog box opens:

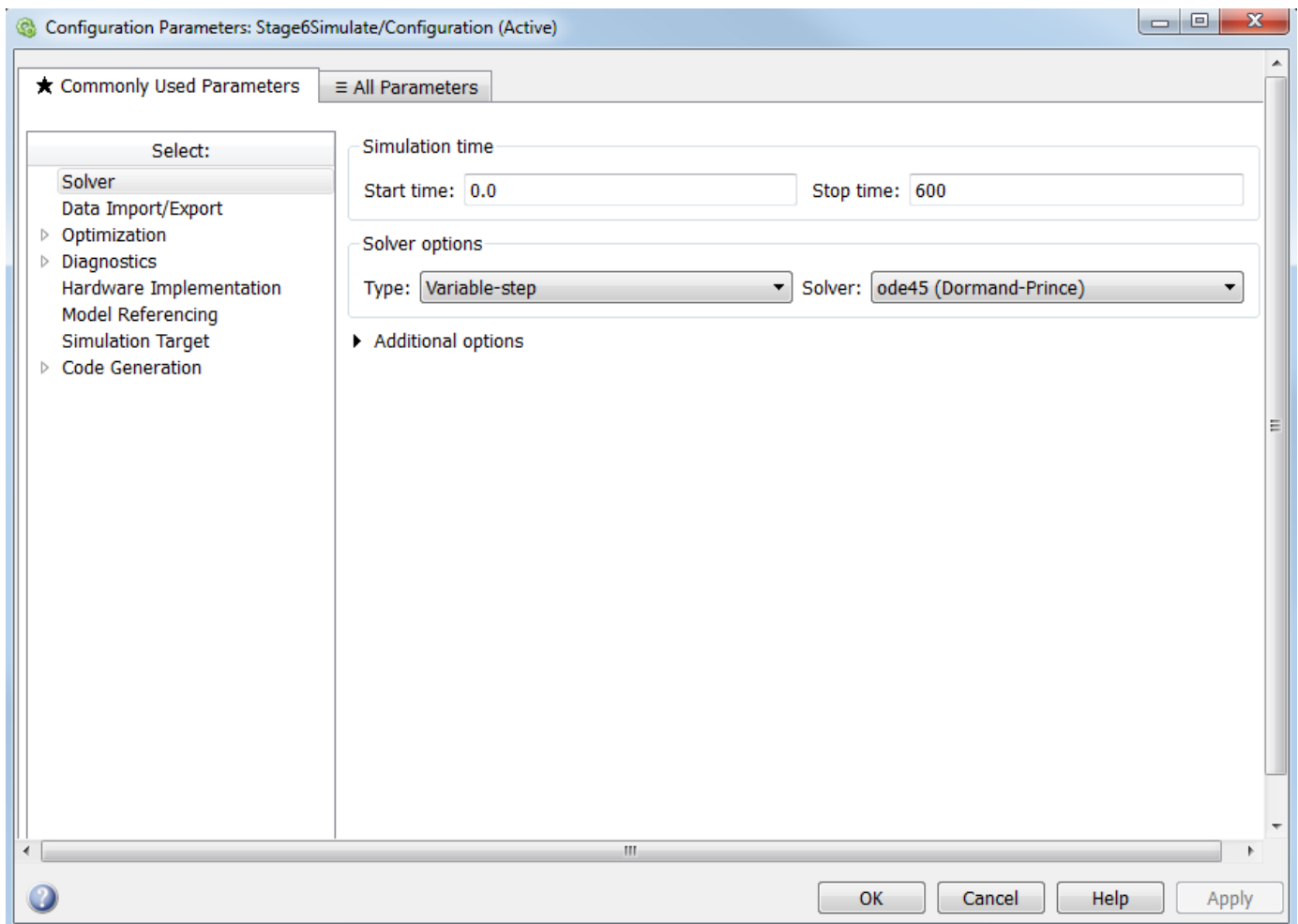

- b Click **Solver** in the left **Select** pane if it is not already selected.

Under **Simulation time** on the right, note that the start and stop times have been preset for you. You can adjust these times later as you become more familiar with the run-time behavior of the chart.

- c Keep the preset values for now and click **OK** to close the dialog box.
- 5 Leave the chart open for the next exercise.

Configuring Animation for the Chart

When you simulate a Simulink model, Stateflow animates charts to highlight states and transitions as they execute. Animation provides visual verification that your chart behaves as you expect. Animation is enabled by default to Fast. Slowing it down gives you more time to view the execution order of objects. To configure animation for your simulation session, follow these steps:

- 1 Set the speed of animation to medium. In the Stateflow Editor, in the **Debug** tab, set the animation speed to **Medium**. This slows the animation down.
- 2 Leave the Air Controller chart open for the next exercise.

Setting Breakpoints to Observe Chart Behavior

In this exercise, you will learn how to set breakpoints to pause simulation during key run-time activities so you can observe the behavior of your chart in slow motion. You will set the following breakpoints:

Breakpoint	Description
Chart Entry	Simulation halts when the Stateflow chart wakes up.
State Entry	Simulation halts when a state becomes active.

You will also learn how to examine data values when simulation pauses.

Follow these steps:

- 1 Right click in the chart, and select **Set Breakpoint on Chart Entry**.
- 2 For each state `PowerOn` and `PowerOff`, right click in the state, and select **Set Breakpoints > On State Entry**.

Simulating the Air Controller Chart

In this exercise, you will simulate the Air Controller chart. During simulation, you will change breakpoints and observe data values when execution pauses. Follow these steps.

- 1 In `Stage6Simulate`, open the Scope block. Position the Scope block and the Air Controller chart so they are visible on your desktop.
- 2 Start simulation by clicking **Run**.

After the simulation target is built, the chart appears with a gray background, indicating that simulation has begun. Simulation continues until it reaches the first breakpoint, when the Air Controller chart wakes up.

- 3 Right click a transition in the state FAN1, and select **Add to watch > (Input) temp**. This adds the variable `temp` to the Stateflow Breakpoints and Watch window.
- 4 Right click in the state `SpeedValue`, and select **Add to watch > (Output) airflow**. This adds the variable `airflow` to the Stateflow Breakpoints and Watch window.

Tip You can also view data values from the MATLAB command line at simulation breakpoints. Here's how to do it:

- a When simulation pauses at a breakpoint, click in the MATLAB command line and press the **Enter** key.

The MATLAB Command Window displays a `debug>>` prompt.

- b At the prompt, type the name of the data object.

The MATLAB Command Window displays the value of the data object.

- 5 View the values of `temp` and `airflow`.

Note that `temp` is 70 (below the threshold for turning on FAN1) and `airflow` is 0 (indicating that no fans are running).

- 6 Resume simulation by clicking the Continue button.

Simulation continues until the next breakpoint, activation of the `PowerOff` state, which appears highlighted in the chart (as part of animation).

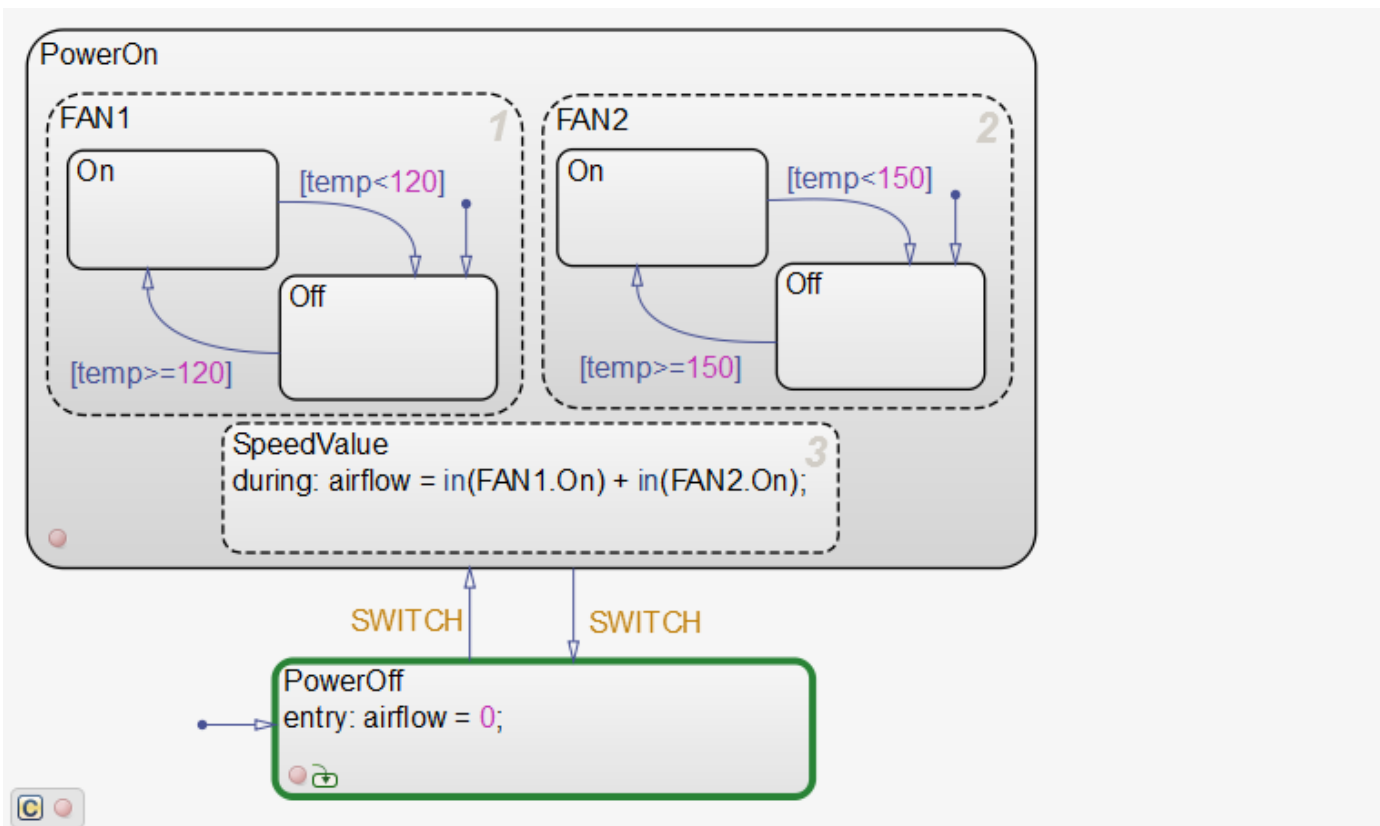

The default transition activates PowerOff after the chart wakes up.

- 7 In the **Breakpoints** tab of the Stateflow Breakpoints and Watch Data window, clear the breakpoint on Chart Entry. Hover the cursor over the name of the breakpoint, and select the delete button, . Continue simulation.

Simulation continues to the next breakpoint, the activation of the PowerOn state:

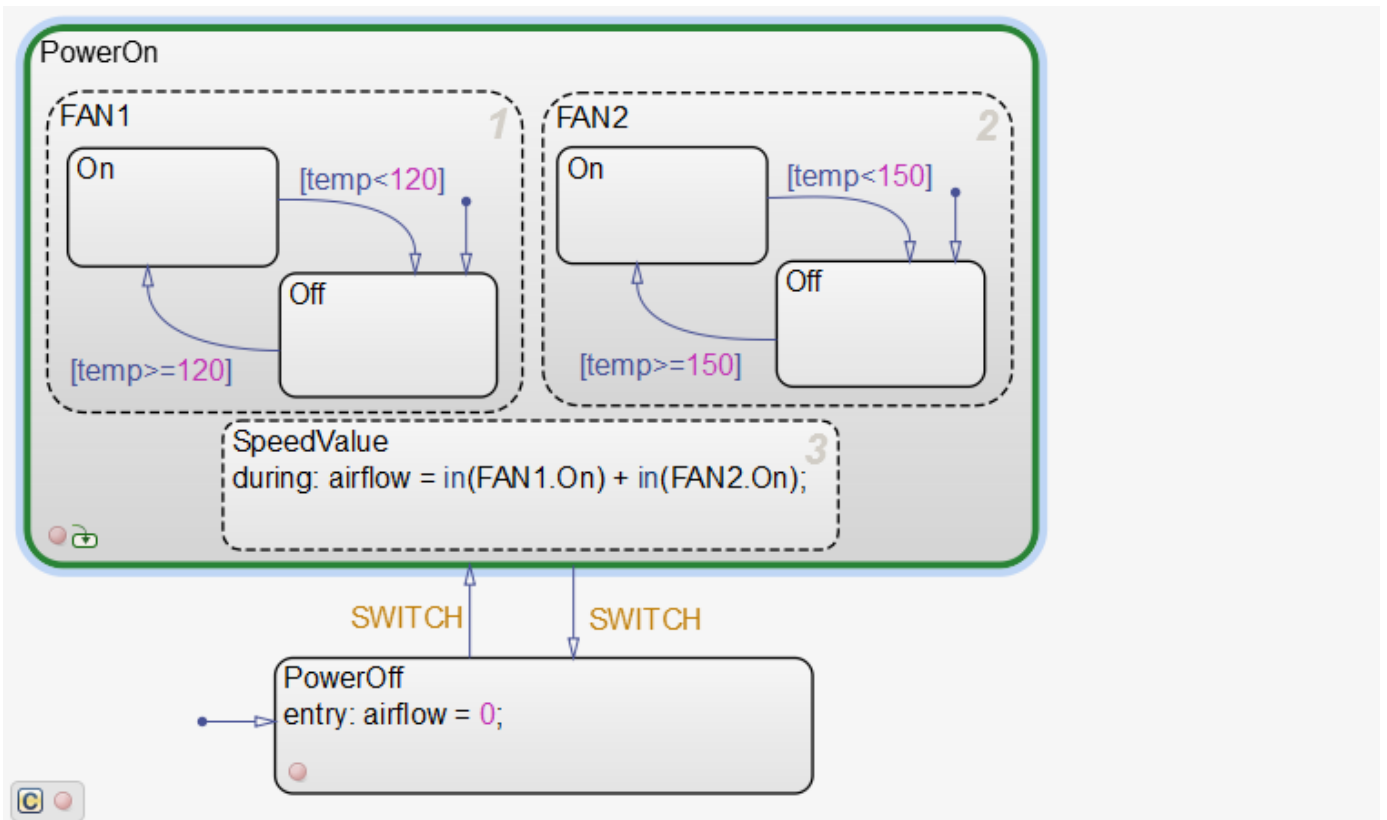

Note that `temp` has risen to over 157 degrees. The Scope displays the temperature pattern:

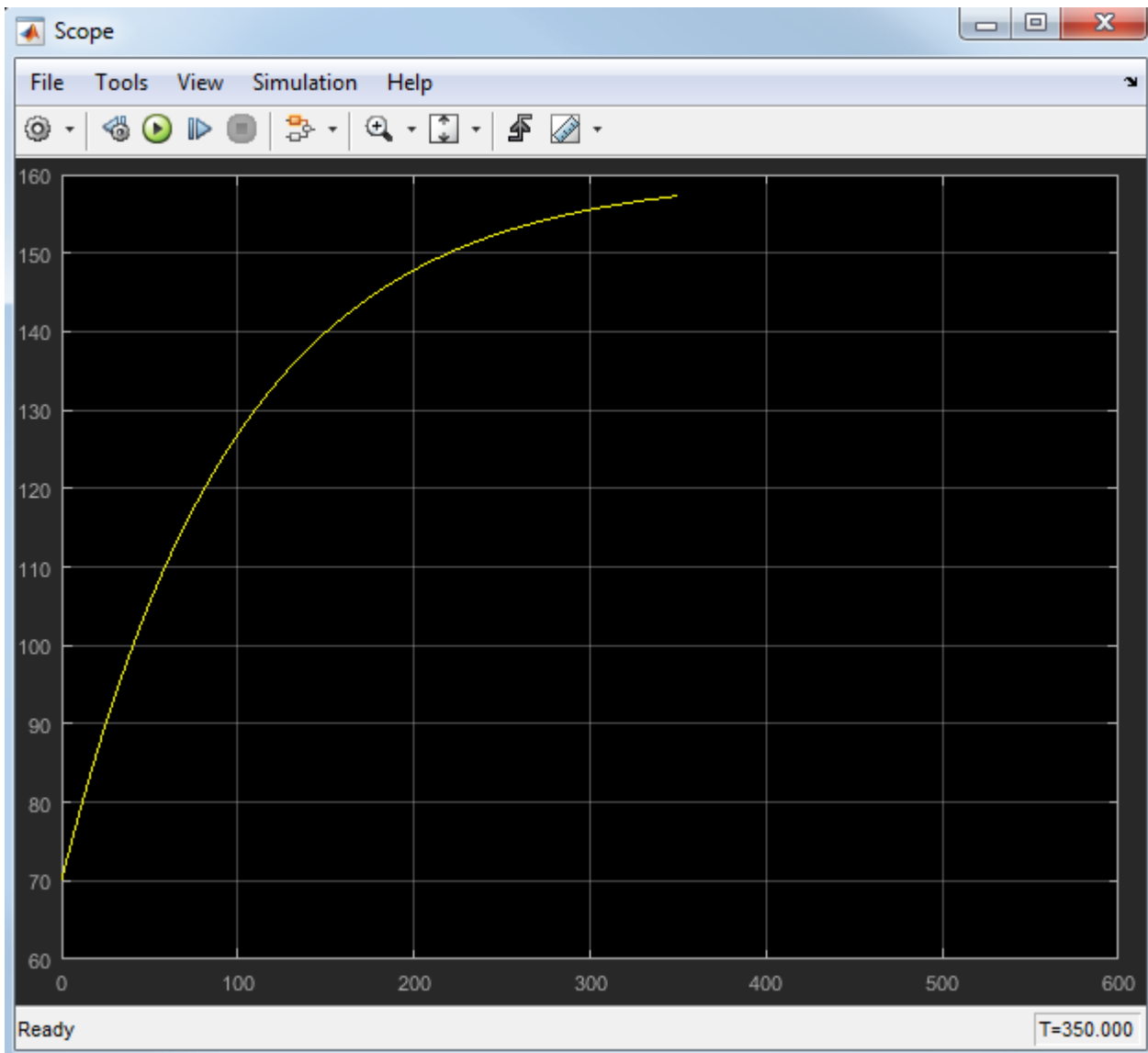

- 8 To speed through the rest of the simulation, clear all breakpoints, and continue simulation.

Notice that FAN1 continues to cycle on and off as temp fluctuates between 119 and 120 degrees until power cycles off at 500 seconds. After power cycles off, the fans stop running and temp begins to rise unchecked until simulation reaches stop time at 600 seconds.

The Scope captures this activity:

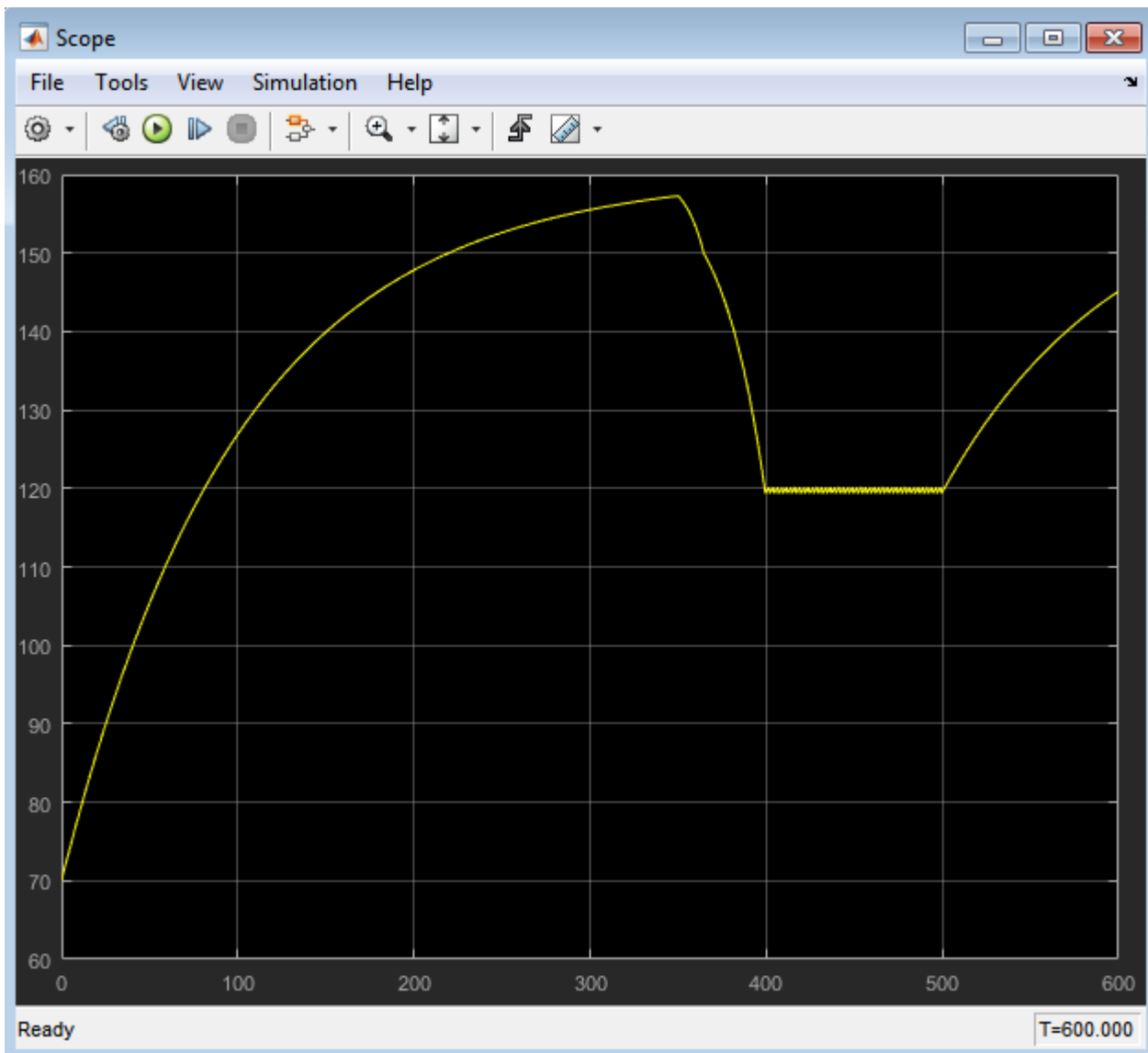

Note This display should look the same as the Scope after running the prebuilt model in “Running the Model” on page 1-10.

- 9 Save Stage6Simulate, and close all other windows and dialog boxes.

Debugging Common Modeling Errors

In phase 7 of this workflow, you *debug the chart*.

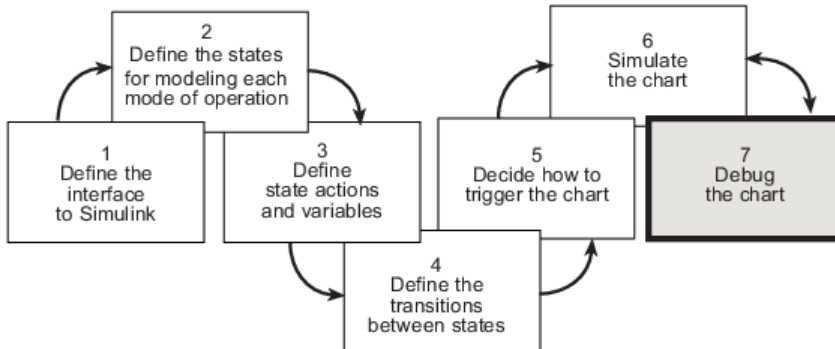

Debugging State Inconsistencies

In this exercise, you will introduce a state inconsistency error in your chart and troubleshoot the problem. Follow these steps:

- 1 Open the model `Stage6Simulate` — either the one you created in the previous exercises or the supplied model for stage 6.

To open the supplied model, enter the following command at the MATLAB prompt:

```
addpath(fullfile(docroot, 'toolbox', 'stateflow', 'gs', 'examples'))
Stage6Simulate
```

- 2 Save the model as `Stage7Debug` in your local work folder.
- 3 Double-click `Air Controller` to open the chart.
- 4 Delete the default transition to `FAN2.Off` by selecting it and pressing the **Delete** key.

Removing the default transition will cause a state inconsistency error. (Recall from “Checking That Your Chart Conforms to Best Practices” on page 1-47 that there must be a default transition at every level of the Stateflow hierarchy that has exclusive [OR] decomposition.)

Your chart should look like this:

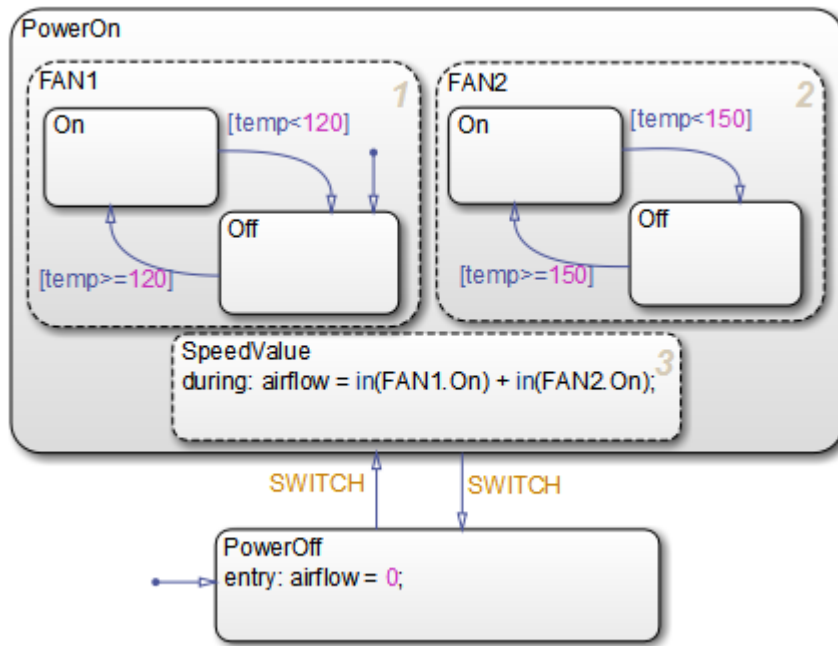

- 5 Save the chart, and start simulation.

An error appears in the Diagnostic Viewer. The error indicates that the state FAN2 has no default paths to a substate.

Note The state number in your dialog display can differ from the one pictured above.

- 6 Locate the offending state in the Air Controller chart, by clicking the link to the state name.

FAN2 appears highlighted in the chart:

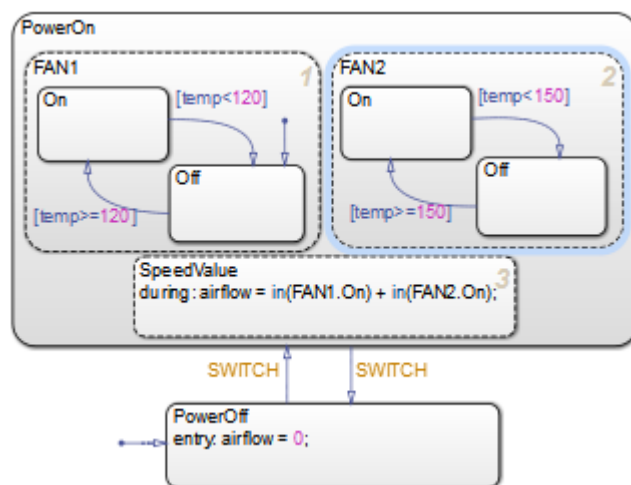

- 7 Add back the default transition to FAN2 .Off.

The default transition provides an unconditional default path to one of the substates of FAN2.

- 8 Simulate the model again.

This time, simulation proceeds without any errors.

- 9 Save Stage7Debug, and leave the chart open for the next exercise.

Debugging Data Range Violations

In this exercise, you will introduce a data range violation in your chart and troubleshoot the problem. To enable data range violation checking, set **Simulation range checking** in the **Diagnostics: Data Validity** pane of the Configuration Parameters dialog box to error.

Follow these steps:

- 1 In the Air Controller chart, modify the during action in the SpeedValue state by adding 1 to the computed value, as follows:

```
during: airflow = in(FAN1.0n) + in(FAN2.0n) + 1;
```

Recall that in “Defining the Inputs and Outputs” on page 1-16, you set a limit range of 0 to 2 for `airflow`. By adding 1 to the computation, the value of `airflow` will exceed the upper limit of this range when two fans are running.

- 2 Start simulation.

Simulation pauses because of an out-of-range data error:

As expected, the error occurs in the during action of SpeedValue because the value of `airflow` is out of range.

- 3 To isolate the problem, double-click the last line in the error message:

```
Data '#439 (0:0:0)': 'airflow'
```

The Model Explorer opens on your desktop, allowing you to view the properties of `airflow` in the right, read-only pane (read-only because simulation is running).

Note The ID number of the data that appears in the error message can vary from the value shown.

- 4 Check the limit range for `airflow`:

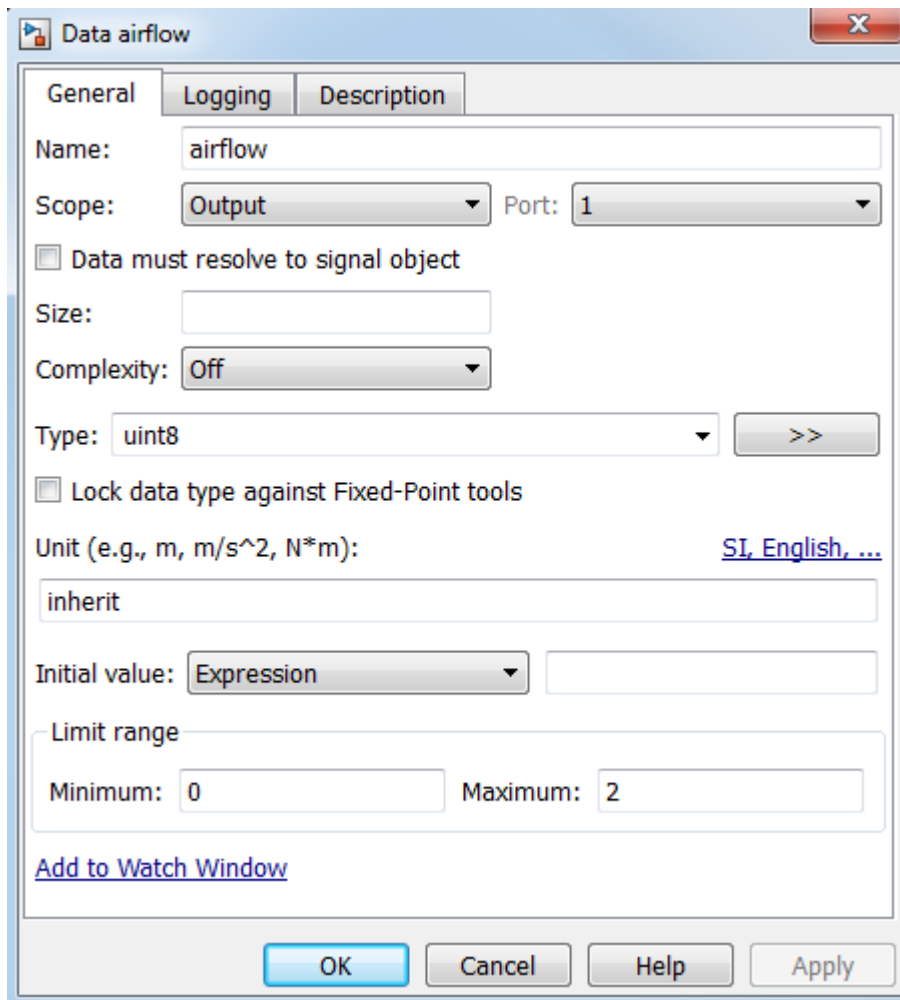

- 5 Hover your cursor over `airflow` to view the value.

`airflow = 3`

This value exceeds the upper limit of 2.

- 6 Stop simulation.
- 7 Restore the `during` action to its previous code, and then restart simulation for the model.

The model should simulate with no errors or warnings.

See Also

Related Examples

- “Set Breakpoints to Debug Charts” on page 33-3
- “Inspect and Modify Data and Messages While Debugging” on page 33-9

Stateflow Chart Notation

- “Overview of Stateflow Objects” on page 2-2
- “Rules for Naming Stateflow Objects” on page 2-5
- “States” on page 2-8
- “State Hierarchy” on page 2-14
- “State Decomposition” on page 2-16
- “Transitions” on page 2-18
- “Self-Loop Transitions” on page 2-24
- “Inner Transitions” on page 2-25
- “Default Transitions” on page 2-28
- “Combine Transitions and Junctions to Create Branching Paths” on page 2-31
- “History Junctions” on page 2-36
- “Reusable Functions in Charts” on page 2-37

Overview of Stateflow Objects

Hierarchy of Stateflow Objects

Stateflow objects are arranged in a hierarchy based on containment. That is, one Stateflow object can contain other Stateflow objects.

Stateflow Hierarchy

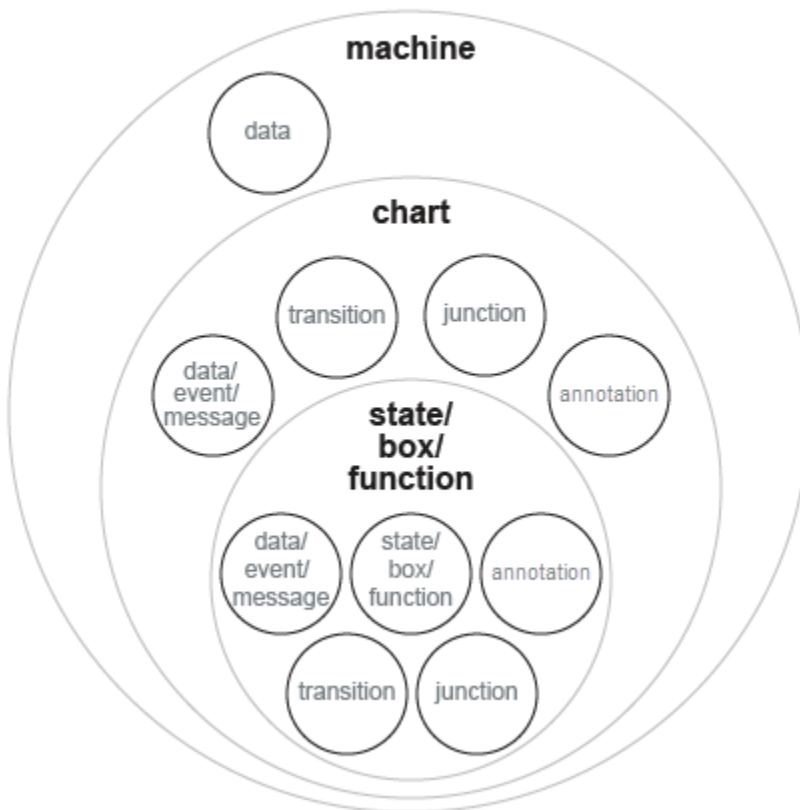











The highest object in Stateflow hierarchy is the Stateflow machine. The Stateflow machine contains all of the Stateflow charts in a Simulink model. In addition, the Stateflow machine for a model can contain its own data.

Stateflow charts can contain states, boxes, functions, data, events, messages, transitions, junctions, and annotations. States, boxes, and functions can contain other states, boxes, functions, transitions, junctions, annotations, data, events, and messages. Levels of nesting can continue indefinitely.

Graphical Objects

To manage graphical objects, use the Stateflow Editor. This table lists each type of graphical object and the palette icon to use for drawing the object.

Type of Graphical Object	Palette Icon	Reference
State		"Represent Operating Modes by Using States" on page 4-5
Transition	Not applicable. Point and drag from the source state to the destination state.	"Transition Between Operating Modes" on page 4-14
Connective junction		"Combine Transitions and Junctions to Create Branching Paths" on page 2-31
Default transition		"Default Transitions" on page 2-28
Box		"Group Chart Objects by Using Boxes" on page 8-22
Simulink based state		"Simulink Subsystems as States" on page 6-2
Simulink function		"Reuse Simulink Components in Stateflow Charts" on page 30-2
Graphical function		"Reuse Logic Patterns by Defining Graphical Functions" on page 8-13
MATLAB function		"Reuse MATLAB Code by Defining MATLAB Functions" on page 29-2
Truth table function		"Use Truth Tables to Model Combinatorial Logic" on page 28-2
History junction		"Record State Activity by Using History Junctions" on page 8-2
Annotation		"Add Descriptive Comments in a Chart" on page 8-32

Nongraphical Objects

You can define data, event, and message objects that do not appear graphically in the Stateflow Editor. To manage nongraphical objects, use the Symbols pane or Model Explorer. For more information, see:

- "Manage Data, Events, and Messages in the Symbols Pane" on page 34-2
- "Use the Model Explorer with Stateflow Objects" on page 34-10

Data Objects

A Stateflow chart stores and retrieves data that it uses to control its execution. Stateflow data resides in its own workspace, but you can also access data that resides externally in the Simulink model or application that embeds the Stateflow machine. You must define any internal or external data that you use in a Stateflow chart.

Event Objects

An event is a Stateflow object that can trigger a whole Stateflow chart or individual actions in a chart. Because Stateflow charts execute by reacting to events, you specify and program events into your charts to control their execution. You can broadcast events to every object in the scope of the object sending the event, or you can send an event to a specific object. You can define explicit events that you specify directly, or you can define implicit events to take place when certain actions are performed, such as entering a state. For more information, see “Synchronize Model Components by Broadcasting Events” on page 11-2.

Message Objects

Stateflow message objects are queued objects that can carry data. You can send a message from one Stateflow chart to another to communicate between charts. You can also send local messages within a chart. You define the type of message data. You can view the lifeline of a message in the Sequence Viewer block. For more information, see “Communicate with Stateflow Charts by Sending Messages” on page 12-2.

Rules for Naming Stateflow Objects

You can name Stateflow objects with any combination of alphanumeric and underscore characters. Names cannot begin with a numeric character or contain embedded spaces.

Restriction on Name Length

Name length should comply with the maximum identifier length enforced by Simulink Coder™ software. You can set the **Maximum identifier length** parameter. The default is 31 characters and the maximum length you can specify is 256 characters.

Keywords to Avoid When Naming Stateflow Objects

Avoid using reserved keywords to name Stateflow objects. These keywords are part of the action language syntax.

Usage in Action Language Syntax	Keywords	Syntax References
Boolean symbols	<ul style="list-style-type: none"> • true • false 	“Boolean Symbols, true and false” on page 13-20
Change detection	<ul style="list-style-type: none"> • hasChanged • hasChangedFrom • hasChangedTo 	“Detect Changes in Data Values” on page 13-56
Complex data	<ul style="list-style-type: none"> • complex • imag • real 	“Supported Operations for Complex Data” on page 24-4
Data types	<ul style="list-style-type: none"> • boolean • double • int64 • int32 • int16 • int8 • single • uint64 • uint32 • uint16 • uint8 	“Specify Type of Stateflow Data” on page 9-27
Data type operations	<ul style="list-style-type: none"> • cast • fixdt • type 	“Type Cast Operations” on page 13-16

Usage in Action Language Syntax	Keywords	Syntax References
Explicit events	<ul style="list-style-type: none"> • send 	“Broadcast Local Events to Synchronize Parallel States” on page 13-37
Implicit events	<ul style="list-style-type: none"> • change • chg • en • enter • ex • exit • tick 	“Control Chart Behavior by Using Implicit Events” on page 11-23
Literal symbols	<ul style="list-style-type: none"> • inf • t 	“Supported Symbols in Actions” on page 13-20
	<ul style="list-style-type: none"> • this 	“Debug a Standalone Stateflow Chart” on page 35-13
MATLAB functions and data	<ul style="list-style-type: none"> • matlab • ml 	“Access MATLAB Functions and Workspace Data in C Charts” on page 13-28
Messages	<ul style="list-style-type: none"> • discard • forward • invalid • length • receive • send 	“Control Message Activity in Stateflow Charts” on page 12-9
State actions	<ul style="list-style-type: none"> • bind • du • during • en • entry • ex • exit • on 	“State Action Types” on page 13-2
State activity	<ul style="list-style-type: none"> • in 	“Check State Activity by Using the in Operator” on page 10-14

Usage in Action Language Syntax	Keywords	Syntax References
String manipulation	<ul style="list-style-type: none"> • <code>ascii2str</code> • <code>str2ascii</code> • <code>str2double</code> • <code>strcat</code> • <code>strcmp</code> • <code>strcpy</code> • <code>strlen</code> • <code>substr</code> • <code>tostring</code> 	"Manage Textual Information by Using Strings" on page 21-2
Temporal logic	<ul style="list-style-type: none"> • <code>after</code> • <code>at</code> • <code>before</code> • <code>count</code> • <code>duration</code> • <code>elapsed</code> • <code>every</code> • <code>msec</code> • <code>sec</code> • <code>t</code> • <code>temporalCount</code> • <code>usec</code> 	"Control Chart Execution by Using Temporal Logic" on page 13-40

Note Do not use the file names `sf.sfx` for Stateflow charts or `sf.slx` for Simulink models. Using these file names can shadow Stateflow program files and result in unpredictable behavior.

See Also

More About

- "Specify Properties for Stateflow Charts" on page 25-2
- "Set Data Properties" on page 9-5
- "Identify Data by Using Dot Notation" on page 9-39

States

A state describes an operating mode of a reactive system. In a Stateflow chart, states are used for sequential design to create state transition diagrams.

States can be active or inactive. The activity or inactivity of a state can change depending on events and conditions. The occurrence of an event drives the execution of the state transition diagram by making states become active or inactive. At any point during execution, active and inactive states exist.

State Hierarchy

To manage multilevel state complexity, use hierarchy in your Stateflow chart. With hierarchy, you can represent multiple levels of subcomponents in a system.

State Hierarchy Example

In the following example, three levels of hierarchy appear in the chart. Drawing one state within the boundaries of another state indicates that the inner state is a substate (or child) of the outer state (or superstate). The outer state is the parent of the inner state.

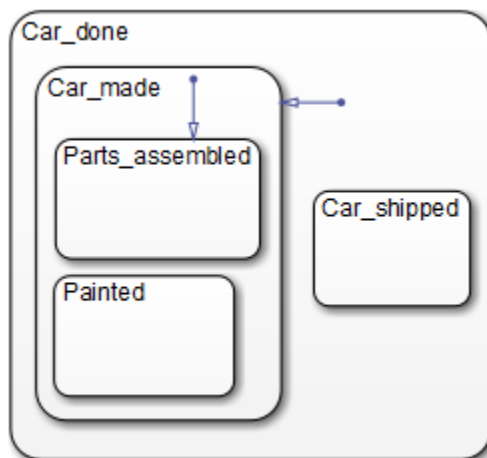

In this example, the chart is the parent of the state `Car_done`. The state `Car_done` is the parent state of the `Car_made` and `Car_shipped` states. The state `Car_made` is also the parent of the `Parts_assembled` and `Painted` states. You can also say that the states `Parts_assembled` and `Painted` are children of the `Car_made` state.

To represent the Stateflow hierarchy textually, use a slash character (`/`) to represent the chart and use a period (`.`) to separate each level in the hierarchy of states. The following list is a textual representation of the hierarchy of objects in the preceding example:

- `/Car_done`
- `/Car_done.Car_made`
- `/Car_done.Car_shipped`
- `/Car_done.Car_made.Parts_assembled`
- `/Car_done.Car_made.Painted`

Objects That a State Can Contain

States can contain all other Stateflow objects. Stateflow chart notation supports the representation of graphical object hierarchy in Stateflow charts with containment. A state is a superstate if it contains other states. A state is a substate if it is contained by another state. A state that is neither a superstate nor a substate of another state is a state whose parent is the Stateflow chart itself.

States can also contain nongraphical data, event, and message objects. The hierarchy of this containment appears in the Model Explorer. You define data, event, and message containment by specifying the parent object.

State Decomposition

Every state (or chart) has a decomposition that dictates what type of substates the state (or chart) can contain. All substates of a superstate must be of the same type as the superstate decomposition. State decomposition can be exclusive (OR) or parallel (AND).

Exclusive (OR) State Decomposition

Substates with solid borders indicate exclusive (OR) state decomposition. Use this decomposition to describe operating modes that are mutually exclusive. When a state has exclusive (OR) decomposition, only one substate can be active at a time.

In the following example, either state A or state B can be active. If state A is active, either state A1 or state A2 can be active at a given time.

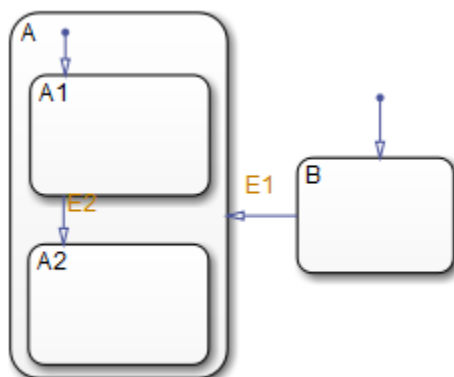

Parallel (AND) State Decomposition

Substates with dashed borders indicate parallel (AND) decomposition. Use this decomposition to describe concurrent operating modes. When a state has parallel (AND) decomposition, all substates are active at the same time.

In the following example, when state A is active, A1 and A2 are both active at the same time.

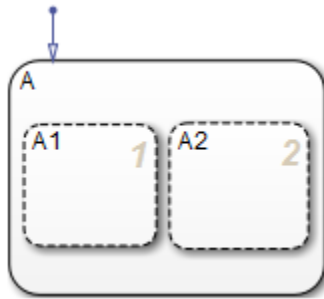

The activity within parallel states is essentially independent, as demonstrated in the following example.

In the following example, when state A becomes active, both states B and C become active at the same time. When state C becomes active, either state C1 or state C2 can be active.

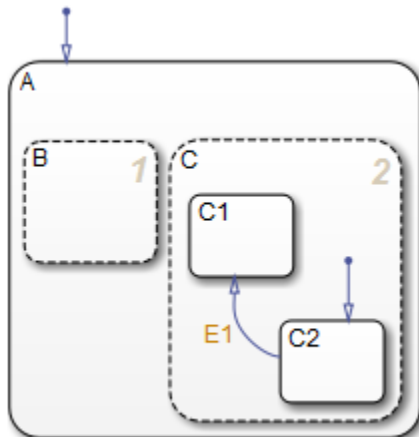

State Labels

The label for a state appears on the top left corner of the state rectangle with the following general format:

```
name/  
entry:entry actions  
during:during actions  
exit:exit actions  
on event_name:on event_name actions  
on message_name:on message_name actions  
bind:events
```

The following example demonstrates the components of a state label.

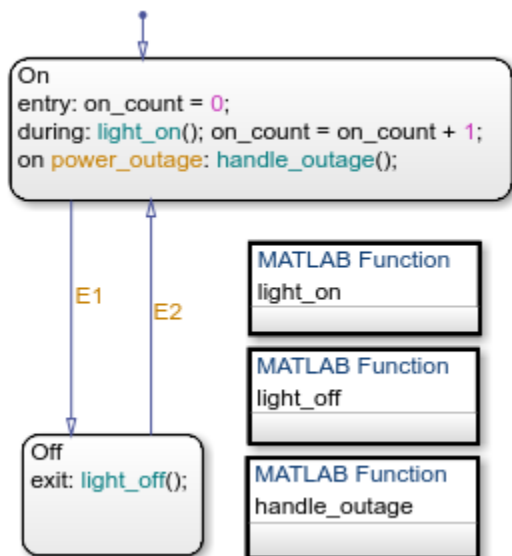

Each action in the state label appears in the subtopics that follow. For more information on state actions, see:

- “Execution of a Stateflow Chart” on page 3-23 — Describes how and when chart execution occurs.
- “State Action Types” on page 13-2 — Gives more detailed descriptions of each type of state action, entry, during, exit.

State Name

A state label starts with the name of the state followed by an optional / character. In the preceding example, the state names are `On` and `Off`. Valid state names consist of alphanumeric characters and can include the underscore (`_`) character. For more information, see “Rules for Naming Stateflow Objects” on page 2-5.

Hierarchy provides some flexibility in naming states. The name that you enter on the state label must be unique when preceded by ancestor states. The name in the Stateflow hierarchy is the text you enter as the label on the state, preceded by the names of parent states separated by periods. Each state can have the same name appear in the label, as long as their full names within the hierarchy are unique. Otherwise, the parser indicates an error.

The following example shows how unique naming of states works.

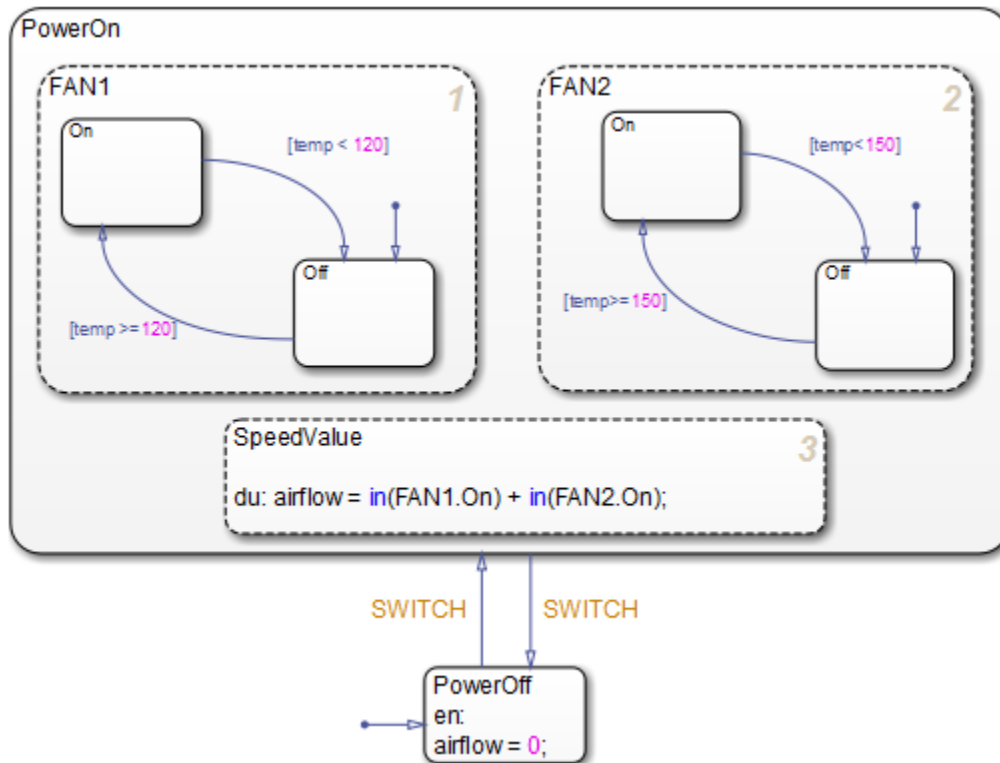

Each of these states has a unique name because of its location in the chart. The full names for the states in FAN1 and FAN2 are:

- PowerOn.FAN1.On
- PowerOn.FAN1.Off
- PowerOn.FAN2.On
- PowerOn.FAN2.Off

State Actions

After the name, you enter optional action statements for the state with a keyword label that identifies the type of action. You can specify none, some, or all of them. The colon after each keyword is required. The slash following the state name is optional as long as it is followed by a carriage return.

For each type of action, you can enter more than one action by separating each action with a carriage return, semicolon, or a comma. You can specify actions for more than one event or message by adding additional `on event_name` or `on message_name` lines.

If you enter the name and slash followed directly by actions, the actions are interpreted as entry action(s). This shorthand is useful if you are specifying only entry actions.

Entry Action

Preceded by the prefix `entry` or `en` for short. In the preceding example, state **On** has entry action `on_count=0`. This means that the value of `on_count` is reset to 0 whenever state **On** becomes active (entered).

During Action

Preceded by the prefix `during` or `du` for short. In the preceding label example, state `On` has two `during` actions, `light_on()` and `on_count++`. These actions are executed whenever state `On` is already active and any event occurs.

Exit Action

Preceded by the prefix `exit` or `ex` for short. In the preceding label example, state `Off` has the `exit` action `light_off()`. If the state `Off` is active, but becomes inactive (exited), this action is executed.

On Action

Preceded by the prefix `on` *event_name*, or `on` *message_name*. In the preceding label example, state `On` has an `on power_outage` action. If state `On` is active and the event `power_outage` occurs, the action `handle_outage()` is executed.

Bind Action

Preceded by the prefix `bind`. Events bound to a state can only be broadcast by that state or its children.

State Hierarchy

To manage multilevel state complexity, use hierarchy in your Stateflow chart. With hierarchy, you can represent multiple levels of subcomponents in a system.

State Hierarchy Example

In the following example, three levels of hierarchy appear in the chart. Drawing one state within the boundaries of another state indicates that the inner state is a substate (or child) of the outer state (or superstate). The outer state is the parent of the inner state.

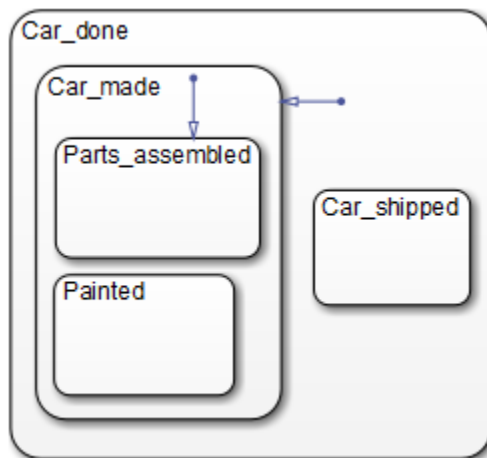

In this example, the chart is the parent of the state `Car_done`. The state `Car_done` is the parent state of the `Car_made` and `Car_shipped` states. The state `Car_made` is also the parent of the `Parts_assembled` and `Painted` states. You can also say that the states `Parts_assembled` and `Painted` are children of the `Car_made` state.

To represent the Stateflow hierarchy textually, use a slash character (`/`) to represent the chart and use a period (`.`) to separate each level in the hierarchy of states. The following list is a textual representation of the hierarchy of objects in the preceding example:

- `/Car_done`
- `/Car_done.Car_made`
- `/Car_done.Car_shipped`
- `/Car_done.Car_made.Parts_assembled`
- `/Car_done.Car_made.Painted`

Objects That a State Can Contain

States can contain all other Stateflow objects. Stateflow chart notation supports the representation of graphical object hierarchy in Stateflow charts with containment. A state is a superstate if it contains other states. A state is a substate if it is contained by another state. A state that is neither a superstate nor a substate of another state is a state whose parent is the Stateflow chart itself.

States can also contain nongraphical data, event, and message objects. The hierarchy of this containment appears in the Model Explorer. You define data, event, and message containment by specifying the parent object.

State Decomposition

Every state (or chart) has a decomposition that dictates what type of substates the state (or chart) can contain. All substates of a superstate must be of the same type as the superstate decomposition. State decomposition can be exclusive (OR) or parallel (AND).

Exclusive (OR) State Decomposition

Substates with solid borders indicate exclusive (OR) state decomposition. Use this decomposition to describe operating modes that are mutually exclusive. When a state has exclusive (OR) decomposition, only one substate can be active at a time.

In the following example, either state A or state B can be active. If state A is active, either state A1 or state A2 can be active at a given time.

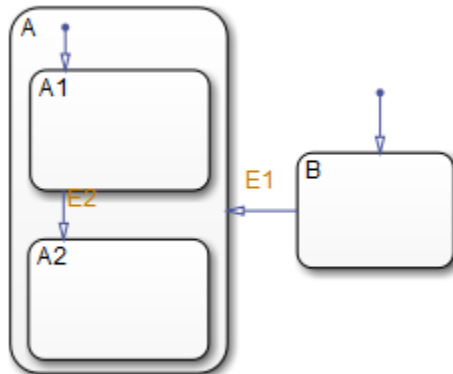

Parallel (AND) State Decomposition

Substates with dashed borders indicate parallel (AND) decomposition. Use this decomposition to describe concurrent operating modes. When a state has parallel (AND) decomposition, all substates are active at the same time.

In the following example, when state A is active, A1 and A2 are both active at the same time.

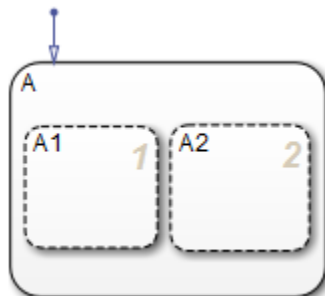

The activity within parallel states is essentially independent, as demonstrated in the following example.

In the following example, when state A becomes active, both states B and C become active at the same time. When state C becomes active, either state C1 or state C2 can be active.

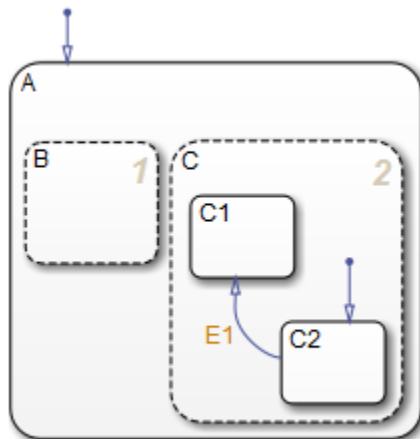

Transitions

A transition is a line with an arrowhead that links one graphical object to another. In most cases, a transition represents the passage of the system from one mode (state) to another. A transition typically connects a source and a destination object. The source object is where the transition begins and the destination object is where the transition ends. The following chart shows a transition from a source state, B, to a destination state, A.

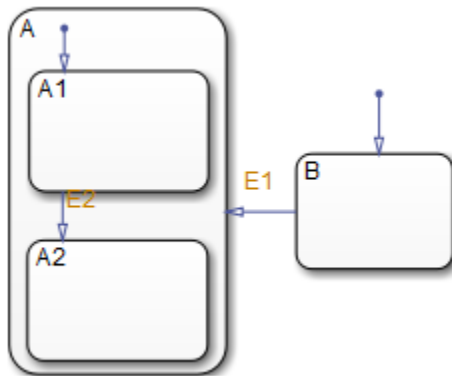

Junctions divide a transition into transition segments. In this case, a full transition consists of the segments taken from the origin to the destination state. Each segment is evaluated in the process of determining the validity of a full transition.

The following example has two segmented transitions: one from state On to state Off, and the other from state On to itself:

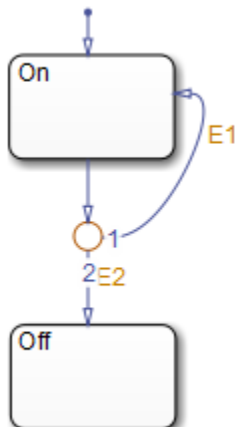

A default transition is a special type of transition that has no source object. See “Default Transitions” on page 2-28 for details.

Transition Hierarchy

Transitions cannot contain other objects the way that states can. However, transitions are contained by states. The hierarchy for a transition is described in terms of its parent, source, and destination states. The parent is the lowest level that contains the source and destination of the transition. Consider the parents for the transitions in the following example:

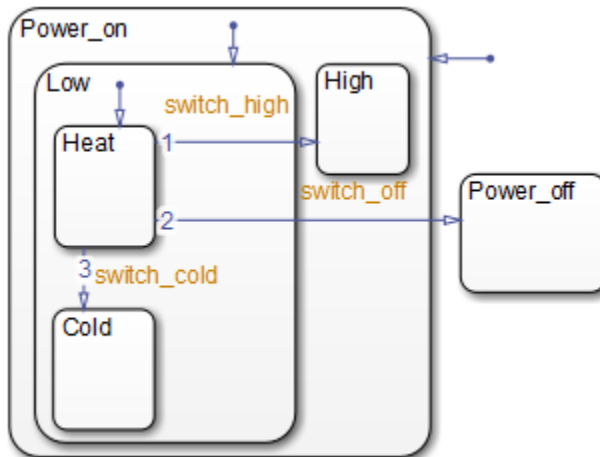

The following table resolves the parentage of each transition in the preceding example. The / character represents the chart. Each level in the hierarchy of states is separated by the period (.) character.

Transition Label	Transition Parent	Transition Source	Transition Destination
switch_off	/	/Power_on.Low.Heat	/Power_off
switch_high	/Power_on	/Power_on.Low.Heat	/Power_on.High
switch_cold	/Power_on.Low	/Power_on.Low.Heat	/Power_on.Low.Cold

Transition Label Notation

A transition label can consist of an event or message, a condition, a condition action, and a transition action. Each part of the label is optional. The ? character is the default transition label. Transition labels have this overall format:

event_or_message[condition]{condition_action}/transition_action

This example illustrates the parts of a transition label.

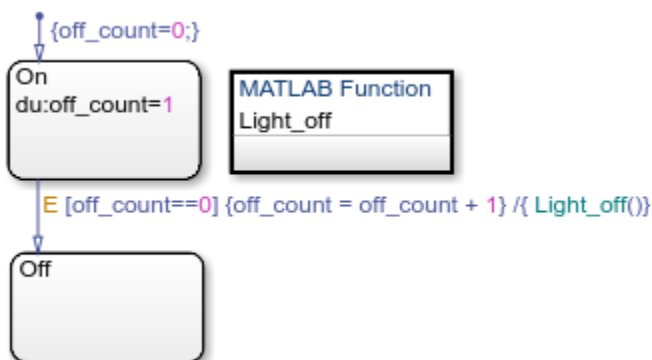

Event or Message Trigger

Specifies an event or message that causes the transition to occur when the condition is true. Specify multiple events using the OR logical operator (|). Specifying an event or message is optional. The

absence of an event or message indicates that the transition takes place on the occurrence of any event. For more information, see “Synchronize Model Components by Broadcasting Events” on page 11-2 and “Communicate with Stateflow Charts by Sending Messages” on page 12-2.

In the previous example, the broadcast of event E triggers the transition from On to Off if the condition `[off_count==0]` is true.

Condition

Specifies a Boolean expression that, when true, validates a transition for the specified event or message trigger. Enclose the condition in square brackets (`[]`). If no condition is specified, an implied condition evaluates to true. For more information, see “Conditions” on page 13-8.

In the previous example, when the event E occurs, the condition `[off_count==0]` must evaluate as true for the transition from On to Off to be valid.

Condition Action

Executes after the condition for the transition is evaluated as true, but before the transition to the destination is determined to be valid. Enclose the condition action in curly braces (`{}`) following the condition. For more information, see “Condition Action Behavior” on page B-9.

In the previous example, if the event E occurs and the condition `[off_count==0]` is true, then the condition action `{off_count = off_count + 1}` is immediately executed.

Transition Action

Executes after the transition to the destination is determined to be valid. If the transition consists of multiple segments, then the transition action is executed when the entire transition path to the final destination is determined to be valid. Transition actions occur after the exit actions of the source state and before the entry actions of the destination state. Precede the transition action with a `/`. For more information, see “Condition and Transition Action Behavior” on page B-9.

In the preceding example, if the event E occurs and the condition `[off_count==0]` is true, then the transition action `{Light_off()}` is executed when the transition from On to Off is determined to be valid. The transition action occurs after On becomes inactive, but before Off becomes active.

Transition actions are supported only in Stateflow charts in Simulink models.

Valid Transitions

Usually, a transition is valid when the source state of the transition is active and the transition label is valid. Default transitions are different because there is no source state. Validity of a default transition to a substate is evaluated when there is a transition to its superstate, assuming the superstate is active. This labeling criterion applies to both default transitions and general case transitions. The following table lists possible combinations of valid transition labels.

Transition Label	Is Valid If..
Event only	That event occurs
Event and condition	That event occurs and the condition is true
Message only	That message occurs

Transition Label	Is Valid If...
Message and condition	That message occurs and the condition is true
Condition only	Any event occurs and the condition is true
Action only	Any event occurs
Not specified	Any event occurs

Transition Connections

Transitions to and from Exclusive (OR) States

This example shows simple transitions to and from exclusive (OR) states.

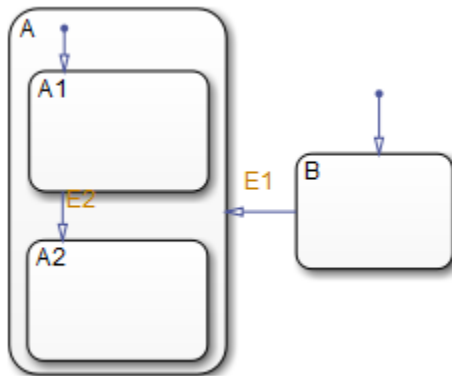

The following transition...	Is valid when...
B to A	State B is active and the event E1 occurs.
A1 to A2	State A1 is active and event E2 occurs.

See “Transition Between Exclusive States” on page B-4 for more information on the semantics of this notation.

Transitions to and from Junctions

The following chart shows transitions to and from connective junctions.

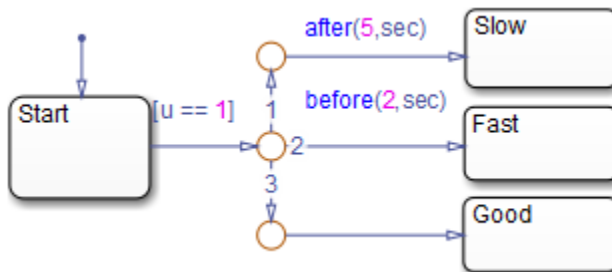

The chart uses temporal logic to determine when the input u equals 1.

If the input equals 1...	A transition occurs from...
Before t = 2	Start to Fast
Between t = 2 and t = 5	Start to Good
After t = 5	Start to Slow

For more information about temporal logic, see “Control Chart Execution by Using Temporal Logic” on page 13-40. For more information on the semantics of this notation, see “Transition from a Common Source to Multiple Destinations” on page B-28.

Transitions to and from Exclusive (OR) Superstates

This example shows transitions to and from an exclusive (OR) superstate and the use of a default transition.

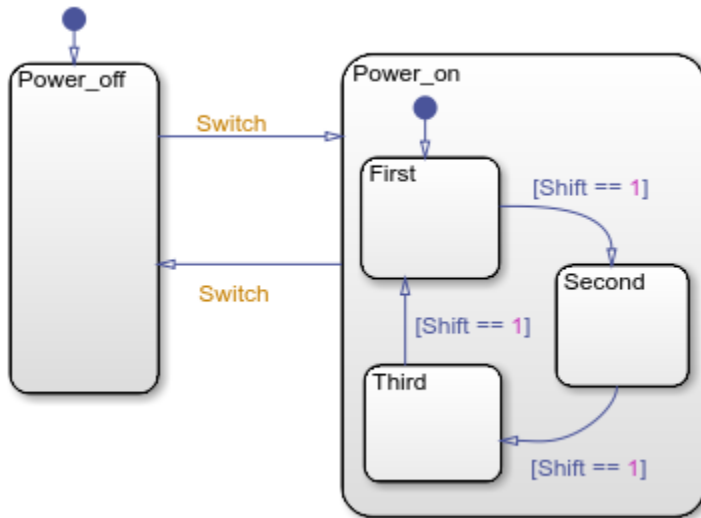

The chart has two states at the highest level in the hierarchy, **Power_off** and **Power_on**. By default, **Power_off** is active. The event **Switch** toggles the system between the **Power_off** and **Power_on** states. **Power_on** has three substates: **First**, **Second**, and **Third**. By default, when **Power_on** becomes active, **First** also becomes active. When **Shift** equals 1, the system transitions from **First** to **Second**, **Second** to **Third**, **Third** to **First**, for each occurrence of the event **Switch**, and then the pattern repeats.

For more information on the semantics of this notation, see “Control Chart Execution by Using Default Transitions” on page B-14.

Transitions to and from Substates

The following example shows transitions to and from exclusive (OR) substates.

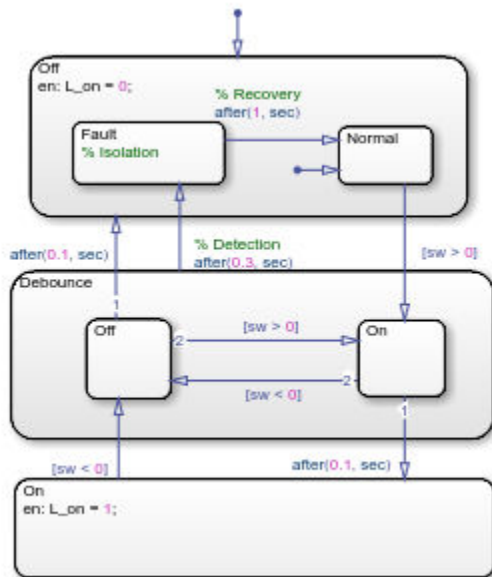

For details on how this chart works, see “Debounce Signals with Fault Detection” on page 27-4. For information on the semantics of this notation, see “Transition from a Substate to a Substate with Events” on page B-7.

See Also

More About

- “Default Transitions” on page 2-28
- “Transition Action Types” on page 13-7
- “Control Chart Execution by Using Condition Actions” on page B-9
- “Synchronize Model Components by Broadcasting Events” on page 11-2
- “Communicate with Stateflow Charts by Sending Messages” on page 12-2

Self-Loop Transitions

A self-loop transition is a transition that originates from and terminates on the same state. The following chart contains four self-loop transitions:

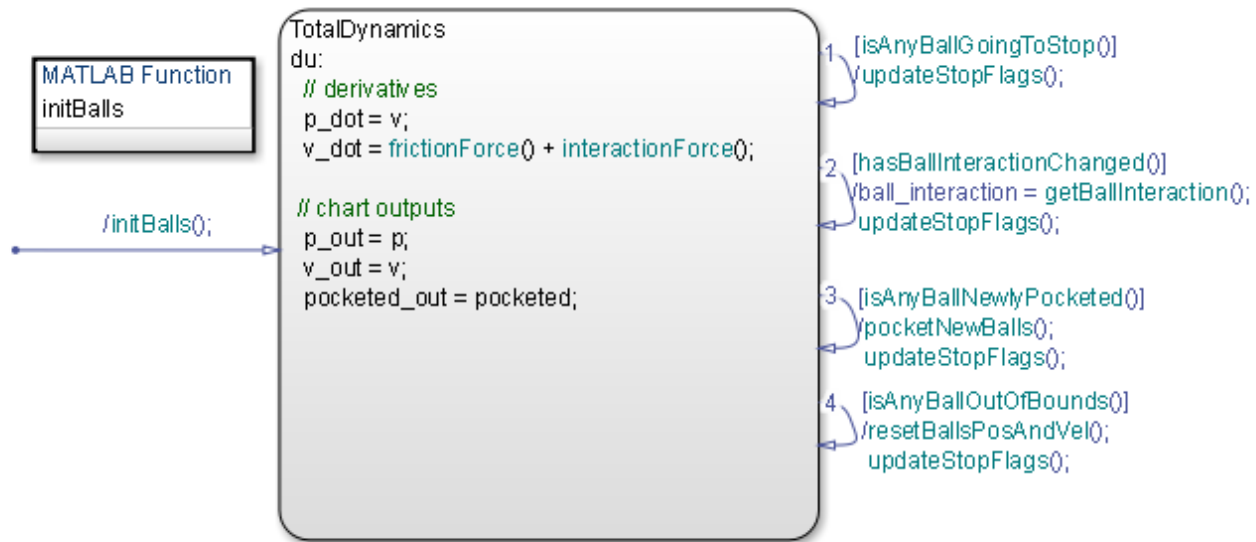

MATLAB Function
yn = isAnyBallOutOfBounds

MATLAB Function f = interactionForce

MATLAB Function
balli = getBallInteraction

MATLAB Function resetBallsPosAndVel

MATLAB Function
yn = hasBallInteractionChanged

MATLAB Function
yn = isAnyBallNewlyPocketed

MATLAB Function pocketNewBalls

MATLAB Function
yn = nearHole(pp)

MATLAB Function
yn = isAnyBallGoingToStop

MATLAB Function updateStopFlags

MATLAB Function
f = frictionForce

See these sections for more information about the semantics of this notation:

- “Self-Loop Transition” on page B-24
- “For-Loop Construct” on page B-25

Inner Transitions

An inner transition is a transition that does not exit the source state. Inner transitions are powerful when defined for superstates with exclusive (OR) decomposition. Use of inner transitions can greatly simplify a Stateflow chart, as shown by the following examples:

- “Before Using an Inner Transition” on page 2-25
- “After Using an Inner Transition to a Connective Junction” on page 2-25
- “Using an Inner Transition to a History Junction” on page 2-26

Before Using an Inner Transition

This chart is an example of how you can simplify logic using an inner transition.

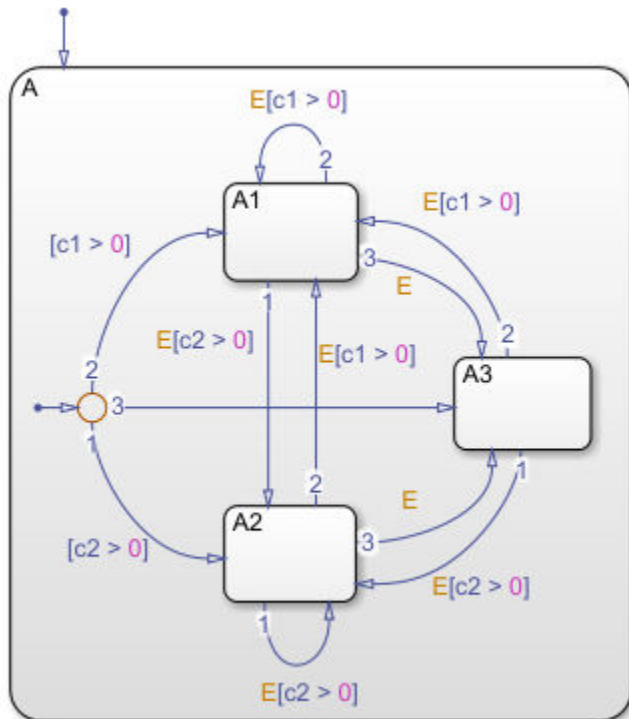

Any event occurs and awakens the Stateflow chart. The default transition to the connective junction is valid. The destination of the transition is determined by $[c1 > 0]$ and $[c2 > 0]$. If $[c1 > 0]$ is true, the transition to A1 is true. If $[c2 > 0]$ is true, the transition to A2 is valid. If neither $[c1 > 0]$ nor $[c2 > 0]$ is true, the transition to A3 is valid. The transitions among A1, A2, and A3 are determined by E, $[c1 > 0]$, and $[c2 > 0]$.

After Using an Inner Transition to a Connective Junction

This example simplifies the preceding example using an inner transition to a connective junction.

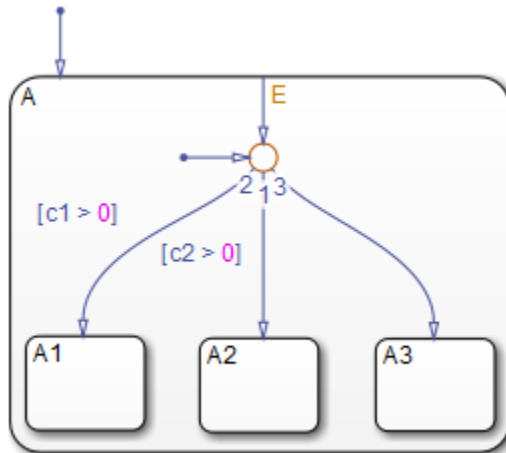

An event occurs and awakens the chart. The default transition to the connective junction is valid. The destination of the transitions is determined by $[c1 > 0]$ and $[c2 > 0]$.

You can simplify the chart by using an inner transition in place of the transitions among all the states in the original example. If state A is already active, the inner transition is used to reevaluate which of the substates of state A is to be active. When event E occurs, the inner transition is potentially valid. If $[c1 > 0]$ is true, the transition to A1 is valid. If $[c2 > 0]$ is true, the transition to A2 is valid. If neither $[c1 > 0]$ nor $[c2 > 0]$ is true, the transition to A3 is valid. This chart design is simpler than the previous one.

Note When you use an inner transition to a connective junction, an active substate can exit and reenter when the transition condition for that substate is valid. For example, if substate A1 is active and $[c1 > 0]$ is true, the transition to A1 is valid. In this case:

- 1 Exit actions for A1 execute and complete.
 - 2 A1 becomes inactive.
 - 3 A1 becomes active.
 - 4 Entry actions for A1 execute and complete.
-

See “Process the First Event with an Inner Transition to a Connective Junction” on page B-20 for more information on the semantics of this notation.

Using an Inner Transition to a History Junction

This example shows an inner transition to a history junction.

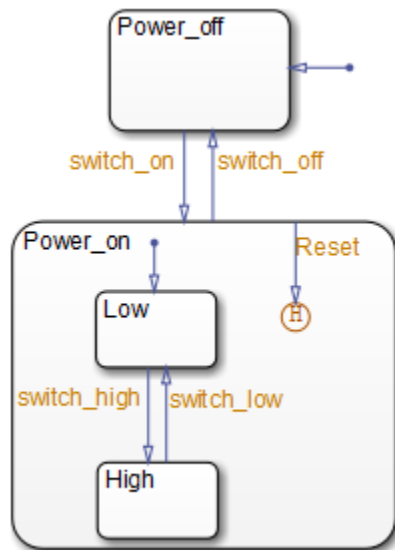

State `Power_on.High` is initially active. When event `Reset` occurs, the inner transition to the history junction is valid. Because the inner transition is valid, the currently active state, `Power_on.High`, is exited. When the inner transition to the history junction is processed, the last active state, `Power_on.High`, becomes active (is reentered). If `Power_on.Low` was active under the same circumstances, `Power_on.Low` would be exited and reentered as a result. The inner transition in this example is equivalent to drawing an outer self-loop transition on both `Power_on.Low` and `Power_on.High`.

See “Example of History Junctions” on page 2-36 for another example using a history junction.

See “Inner Transition to a History Junction” on page B-21 for more information on the semantics of this notation.

Default Transitions

A default transition specifies which exclusive (OR) state to enter when there is ambiguity among two or more neighboring exclusive (OR) states. A default transition has a destination but no source object. For example, a default transition specifies which substate of a superstate with exclusive (OR) decomposition the system enters by default, in the absence of any other information, such as a history junction. A default transition can also specify that a junction should be entered by default.

Drawing Default Transitions

Click the **Default transition** button in the toolbar, and click a location in the drawing area close to the state or junction you want to be the destination for the default transition. Drag the mouse to the destination object to attach the default transition. In some cases, it is useful to label default transitions.

A common programming mistake is to create multiple exclusive (OR) states without a default transition. In the absence of the default transition, there is no indication of which state becomes active by default. Note that this error is flagged when you simulate the model with the **State Inconsistencies** option enabled.

Label Default Transitions

You can label default transitions as you would other transitions. For example, you might want to specify that one state or another should become active depending upon the event that has occurred. In another situation, you might want to have specific actions take place that are dependent upon the destination of the transition.

Tip When labeling default transitions, ensure that there is at least one valid default transition. Otherwise, a chart can transition into an inconsistent state.

Default Transition Examples

The following examples show the use of default transitions in Stateflow charts:

- “Default Transition to a State Example” on page 2-28
- “Default Transition to a Junction Example” on page 2-29
- “Default Transition with a Label Example” on page 2-30

Default Transition to a State Example

This example shows a default transition to a state.

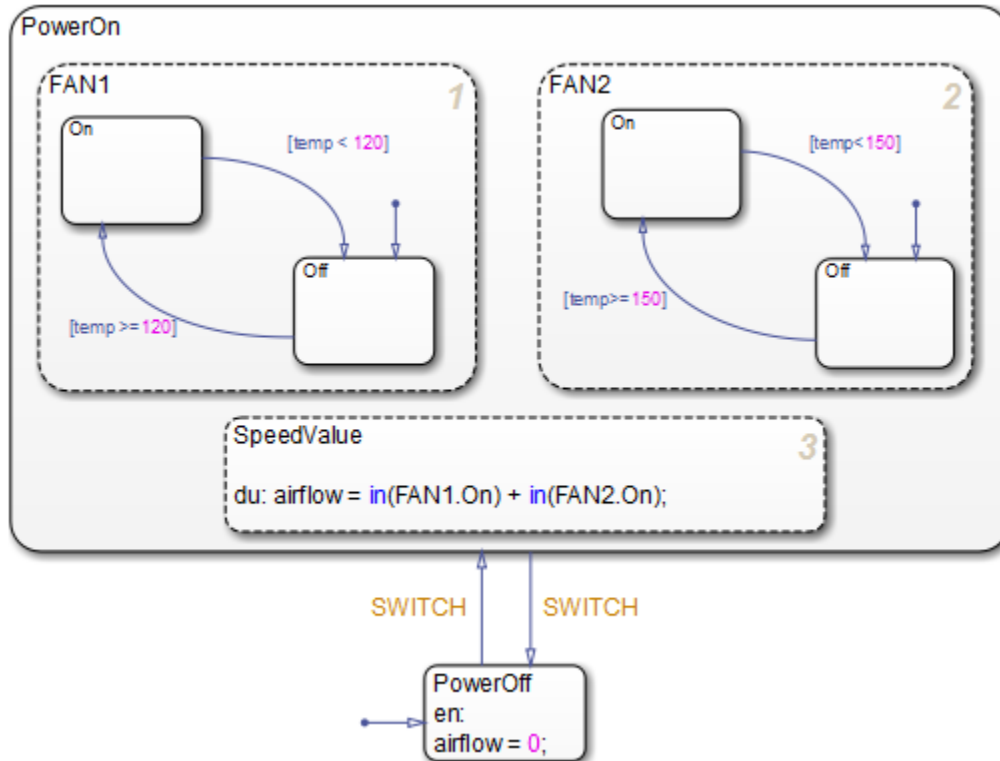

Without the default transition to state **PowerOff**, when the Stateflow chart wakes up, none of the states becomes active. A state inconsistency error is reported at run time.

See “Control Chart Execution by Using Default Transitions” on page B-14 for information on the semantics of this notation.

Default Transition to a Junction Example

This example shows a default transition to a connective junction.

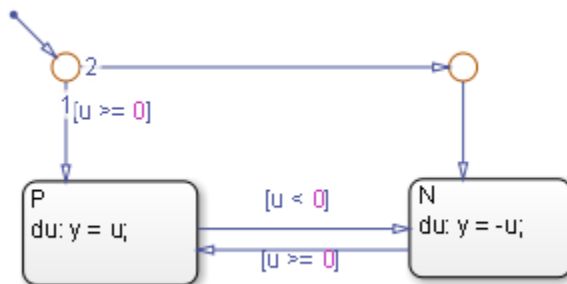

The default transition to the connective junction defines that upon entering the chart, the destination depends on the condition of each transition segment.

See “Default Transition to a Junction” on page B-14 for information on the semantics of this notation.

Default Transition with a Label Example

This example shows a default transition with a label.

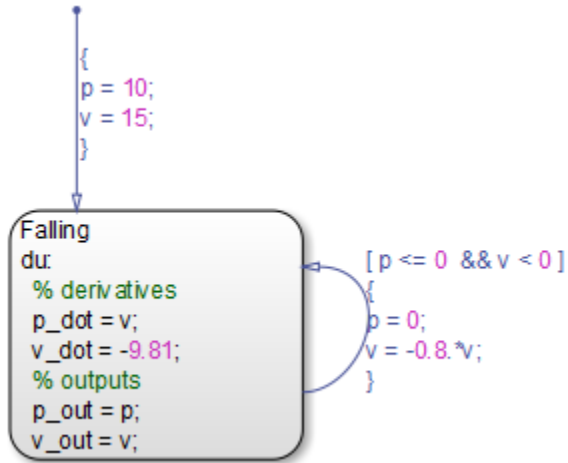

When the chart wakes up, the data `p` and `v` initialize to 10 and 15, respectively.

See “Labeled Default Transitions” on page B-16 for more information on the semantics of this notation.

Combine Transitions and Junctions to Create Branching Paths

A connective junction represents a decision point in a transition path. You can combine transitions and connective junctions to create paths from a common source to multiple destinations or from multiple sources to a common destination. For more information on the semantics of branching paths, see “Represent Multiple Paths by Using Connective Junctions” on page B-23.

Add a Connective Junction

When you add a transition to a chart, the Stateflow Editor provides graphical cues that allow you to add a junction or a state. To place a junction at the end of the transition, click the circular junction cue.

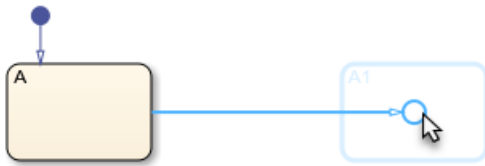

Alternatively, to add an isolated junction to a chart:

- 1 Open the Stateflow Editor.
- 2 From the object palette, click the **Junction** icon  and move the pointer to the chart canvas. A connective junction appears.
- 3 To place the connective junction, click a location on the canvas.

Modify Connective Junction Properties

To change the size of one or more connective junctions:

- 1 Select the connective junctions.
- 2 Right-click one of the selected junctions and select **Junction Size**.
- 3 From the drop-down list, select a junction size.

To change other properties of a connective junction, right-click a connective junction and select **Properties**. The Connective Junction dialog box displays these properties:

- **Parent** — Parent state of the connective junction. To bring the parent to the foreground, click the hypertext link. This property is read-only.
- **Description** — Textual description of the junction. You can enter a brief description and comments.
- **Document link** — Link to online documentation for the junction. You can enter a web URL address or a MATLAB command that displays documentation in a suitable online format, such as an HTML file or text in the MATLAB Command Window. When you click the **Document link** hyperlink, Stateflow evaluates the link and displays the documentation.

Examples of Transition Paths with Connective Junctions

By combining transitions and connective junctions, you can construct common transition patterns such as:

- `if-then-else` decision patterns
- `for` loop patterns
- `while` loop patterns

To reduce the creation time of these patterns, use the Pattern Wizard. For more information, see “Create Flow Charts by Using Pattern Wizard” on page 5-5.

If-then-else Pattern with All Conditions Specified

In this example, the state `Checked_in` has a default transition path with three connective junctions. Each branch of the path is guarded by a condition.

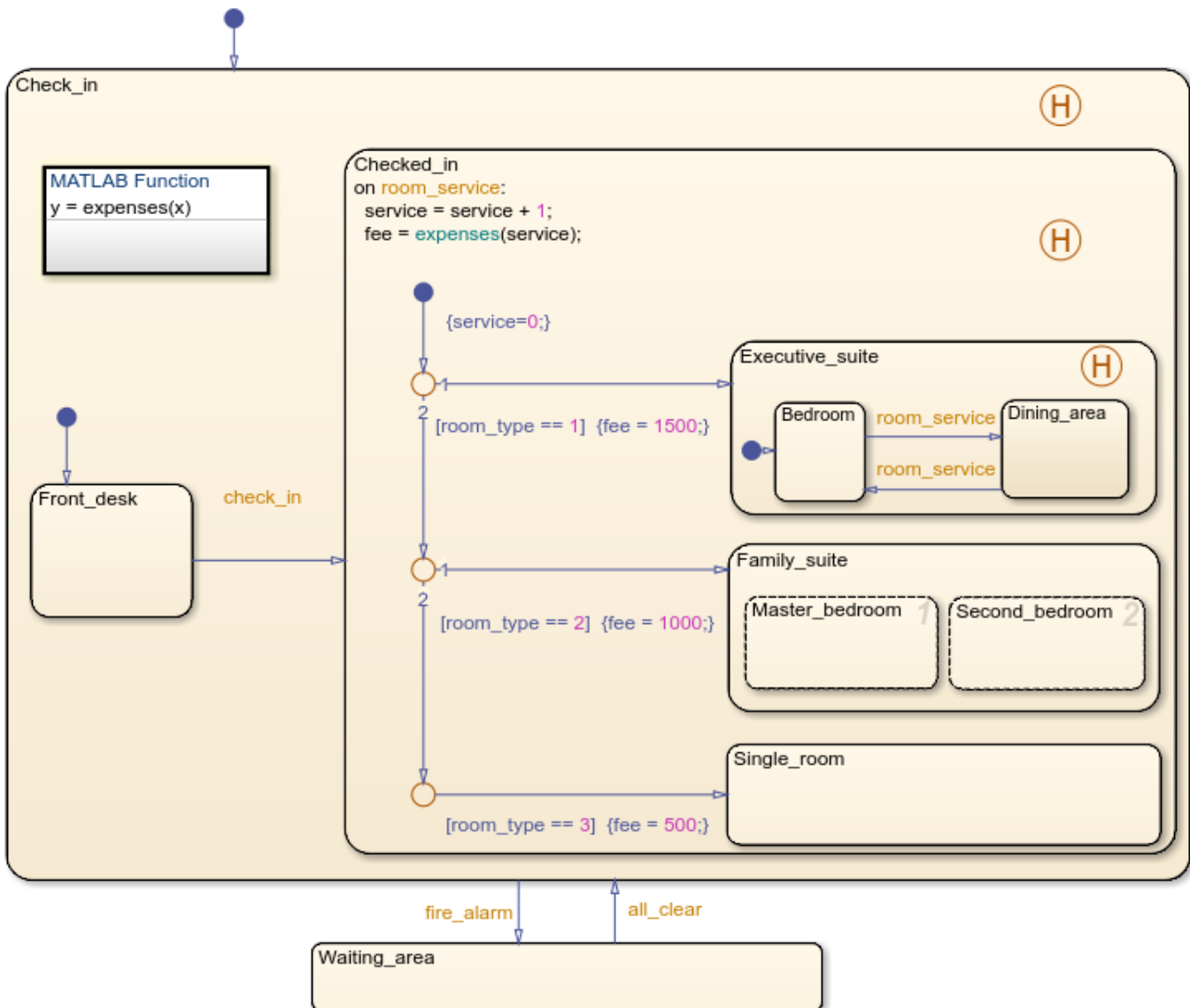

If the state `Front_desk` is active, the event `check_in` triggers the execution of the default transition in `Checked_in`. The outcome of the default transition depends on the value of `room_type`:

- If `room_type` is 1, the substate `Executive_suite` becomes active.
- If `room_type` is 2, the substate `Family_suite` becomes active.
- If `room_type` is 3, the substate `Single_room` becomes active.
- If none of these conditions is true, the default transition path is not valid and `Front_desk` remains active.

For more information about this chart, see “How Stateflow Objects Interact During Execution” on page 3-5.

If-then-else Pattern with an Unconditional Transition

In this example, the transition from state *Start* has three connective junctions. The first two branches of the path are guarded by a condition. The last branch of the path is unconditional.

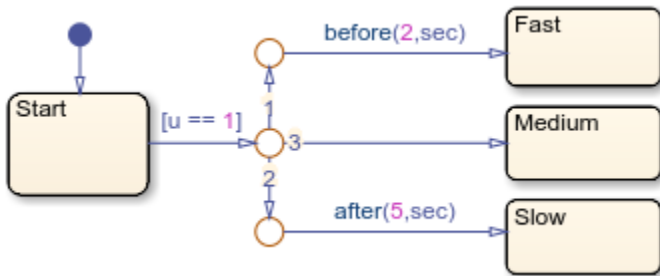

The chart uses temporal logic to determine when the input *u* equals 1:

- If *u* equals 1 before time $t = 2$, the state *Fast* becomes active.
- If *u* equals 1 between $t = 2$ and $t = 5$, the state *Good* becomes active.
- If *u* equals 1 after $t = 5$, the state *Slow* becomes active.

For more information about this chart, see “Detect Elapsed Time” on page 13-46.

For Loop Pattern

In this example, a flow chart uses a combination of transitions and connective junctions to construct a for loop.

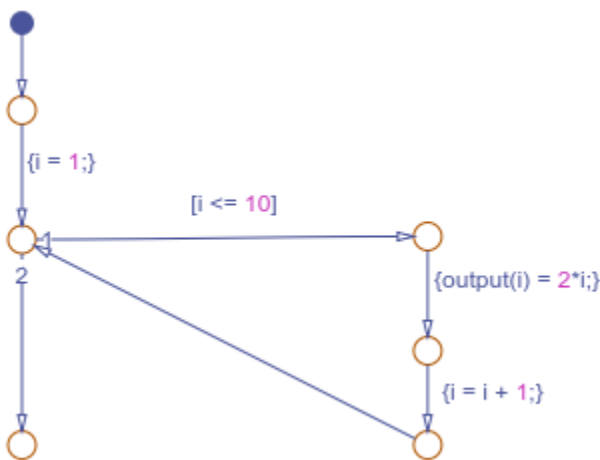

As the value of the counter *i* increases from 1 to 10, the flow chart defines the elements of an array *output*. The loop in this flow chart is equivalent to this snippet of MATLAB code:

```

for i = 1:10
    output(i) = 2*i;
end

```

While Loop Pattern

In this example, a flow chart combines transitions and connective junctions to construct a while loop that computes the greatest common divisor of the inputs.

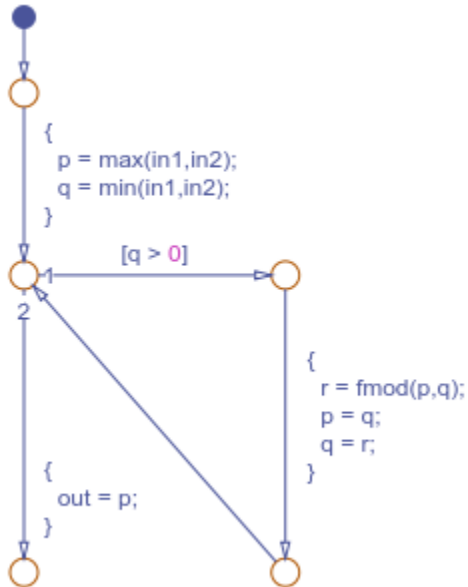

The loop in this flow chart is equivalent to this snippet of C code:

```

while(q > 0) {
    r = fmod(p, q);
    p = q;
    q = r;
}

```

See Also

More About

- “Create Flow Charts by Using Pattern Wizard” on page 5-5
- “Represent Multiple Paths by Using Connective Junctions” on page B-23
- “How Stateflow Objects Interact During Execution” on page 3-5
- “Control Chart Execution by Using Temporal Logic” on page 13-40

History Junctions

A history junction represents historical decision points in the Stateflow chart. The decision points are based on historical data relative to state activity. Placing a history junction in a superstate indicates that historical state activity information is used to determine the next state to become active. The history junction applies only to the level of the hierarchy in which it appears.

Example of History Junctions

The following example uses a history junction:

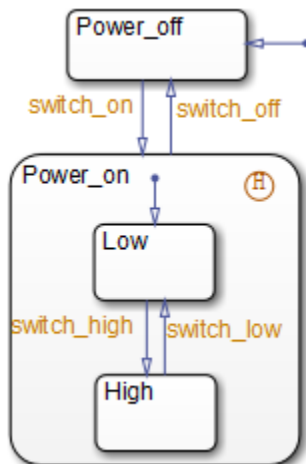

Superstate **Power_on** has a history junction and contains two substates. If state **Power_off** is active and event `switch_on` occurs, the system can enter **Power_on.Low** or **Power_on.High**. The first time superstate **Power_on** is entered, substate **Power_on.Low** is entered because it has a default transition. At some point afterward, if state **Power_on.High** is active and event `switch_off` occurs, superstate **Power_on** is exited and state **Power_off** becomes active. Then event `switch_on` occurs. Because **Power_on.High** was the last active substate, it becomes active again. After the first time **Power_on** becomes active, the history junction determines whether to enter **Power_on.Low** or **Power_on.High**.

See “Default Transition and a History Junction” on page B-15 for more information on the semantics of this notation.

History Junctions and Inner Transitions

By specifying an inner transition to a history junction, you can specify that, based on a specified event or condition, the active state is to be exited and then immediately reentered.

See “Using an Inner Transition to a History Junction” on page 2-26 for an example of this notation.

See “Inner Transition to a History Junction” on page B-21 for more information on the semantics of this notation.

Reusable Functions in Charts

State actions and transition conditions can be complicated enough that defining them inline on the state or transition is not feasible. In this case, express the conditions or actions using one of the following types of Stateflow functions:

- Flow chart — Encapsulate flow charts containing if-then-else, switch-case, for, while, or do-while patterns. For more information, see “Reuse Logic Patterns by Defining Graphical Functions” on page 8-13.
- MATLAB — Write matrix-oriented algorithms; call MATLAB functions for data analysis and visualization. For more information, see “Reuse MATLAB Code by Defining MATLAB Functions” on page 29-2.
- Simulink — Call Simulink function-call subsystems directly to streamline design and improve readability. For more information, see “Reuse Simulink Components in Stateflow Charts” on page 30-2.
- Truth table — Represent combinational logic for decision-making applications such as fault detection and mode switching. For more information, see “Use Truth Tables to Model Combinatorial Logic” on page 28-2.

Use the function format that is most natural for the type of calculation required in the state action or transition condition.

If the four standard types of Stateflow functions do not work, you can write your own C or C++ code for integration with your chart. For more information about custom code integration, see “Reuse Custom Code in Stateflow Charts” on page 31-19.

See Also

More About

- “Reuse Logic Patterns by Defining Graphical Functions” on page 8-13
- “Reuse MATLAB Code by Defining MATLAB Functions” on page 29-2
- “Use Truth Tables to Model Combinatorial Logic” on page 28-2
- “Reuse Simulink Components in Stateflow Charts” on page 30-2
- “Reuse Custom Code in Stateflow Charts” on page 31-19

Stateflow Semantics

- “Stateflow Semantics” on page 3-2
- “How Stateflow Objects Interact During Execution” on page 3-5
- “Modeling Guidelines for Stateflow Charts” on page 3-19
- “Types of Chart Execution” on page 3-21
- “Execution of a Stateflow Chart” on page 3-23
- “Enter a Chart or State” on page 3-28
- “Exit a State” on page 3-34
- “Evaluate Transitions” on page 3-37
- “Super Step Semantics” on page 3-45
- “Use Events to Execute Charts” on page 3-51
- “Group and Execute Transitions” on page 3-56
- “Execution Order for Parallel States” on page 3-58

Stateflow Semantics

In Stateflow, semantics describe the execution behavior of your Stateflow chart. Various factors can affect how your chart executes, including:

- Explicit or implicit ordering of states
- Transition ordering between states
- Events sent by parallel or superstates

As you build your chart, you expect it to behave in a certain way. By knowing how these factors affect your chart, you can create a chart that behaves with intentional interaction of the graphical and nongraphical objects. Graphical and nongraphical objects are the building blocks for all Stateflow charts.

Stateflow Objects

Stateflow objects are the building blocks of Stateflow charts. These objects can be categorized as either graphical or nongraphical. Graphical objects consist of objects that appear graphically in a chart. Nongraphical objects appear textually in a chart and often refer to data, events, and messages. This chart shows a variety of both graphical and nongraphical objects.

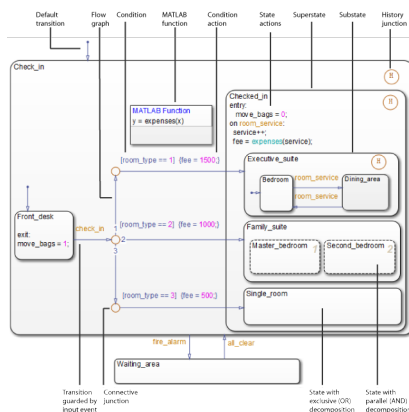

Graphical Objects

To build graphical objects, use the object palette in the Stateflow Editor (see “Stateflow Editor Operations” on page 4-20).

Graphical Objects	Types	References
Flow charts	Decision logic patterns	“Flow Charts in Stateflow” on page 5-2
	Loop logic patterns	
Functions	Graphical functions	“Reuse Logic Patterns by Defining Graphical Functions” on page 8-13
	MATLAB functions	“Reuse MATLAB Code by Defining MATLAB Functions” on page 29-2

Graphical Objects	Types	References
	Truth table functions	“Use Truth Tables to Model Combinatorial Logic” on page 28-2
	Simulink functions	“Reuse Simulink Components in Stateflow Charts” on page 30-2
Junctions	Connective junctions	“Combine Transitions and Junctions to Create Branching Paths” on page 2-31
	History junctions	“History Junctions” on page 2-36
States	States with exclusive (OR) decomposition	“Exclusive (OR) State Decomposition” on page 2-9
	States with parallel (AND) decomposition	“Parallel (AND) State Decomposition” on page 2-9
	Substates and superstates	“Create Substates and Superstates” on page 4-5
Transitions	Default transitions	“Default Transitions” on page 2-28
	Object-to-object transitions	“Transition Connections” on page 2-21
	Inner transitions	
	Self-loop transitions	

Nongraphical Objects

You create nongraphical objects textually in your chart. See “Add Stateflow Data” on page 9-2, “Define Events in a Chart” on page 11-2, and “Define Messages in a Chart” on page 12-2 for details. Examples of nongraphical objects include:

Nongraphical Object	Description	Reference
Condition	Boolean expression that specifies that a transition path is valid if the expression is true; part of a transition label	“Transition Label Notation” on page 2-19 and “Conditions” on page 13-8
Condition action	Action that executes as soon as the condition evaluates to true; part of a transition label	“Transition Label Notation” on page 2-19 and “Condition Actions” on page 13-8
State actions	Expressions that specify actions to take when a state is active, such as initializing or updating data; part of a state label	“State Labels” on page 2-10 and “State Action Types” on page 13-2
Function calls	Expression used to activate a specific function within a chart.	“Reuse MATLAB Code by Defining MATLAB Functions” on page 29-2 and “Reuse Simulink Components in Stateflow Charts” on page 30-2
Temporal logic statements	Operators that are used to control chart actions.	“Control Chart Execution by Using Temporal Logic” on page 13-40

See Also

More About

- “Graphical Objects” on page 2-2
- “Nongraphical Objects” on page 2-3
- “Types of Chart Execution” on page 3-21

How Stateflow Objects Interact During Execution

During execution, Stateflow objects interact with each other to simulate real-world behavior. In the following model, different Stateflow objects are shown and their interactions are explained.

Overview of the Example Model

The example model shows how common graphical and nongraphical objects in a chart interact during execution. These objects include:

- Conditions and condition actions
- Exclusive (OR) states
- Flow charts
- Function calls
- History junctions
- Parallel (AND) states
- State actions
- Transitions guarded by input events

For details of the chart semantics, see “Phases of Chart Execution” on page 3-8.

Model of the Check-In Process for a Hotel

This example uses the hotel check-in process to explain Stateflow chart semantics.

The `sf_semantics_hotel_checkin` model consists of four Manual Switch blocks, one Mux block, one Multiport Switch block, a Hotel chart, and a Display block.

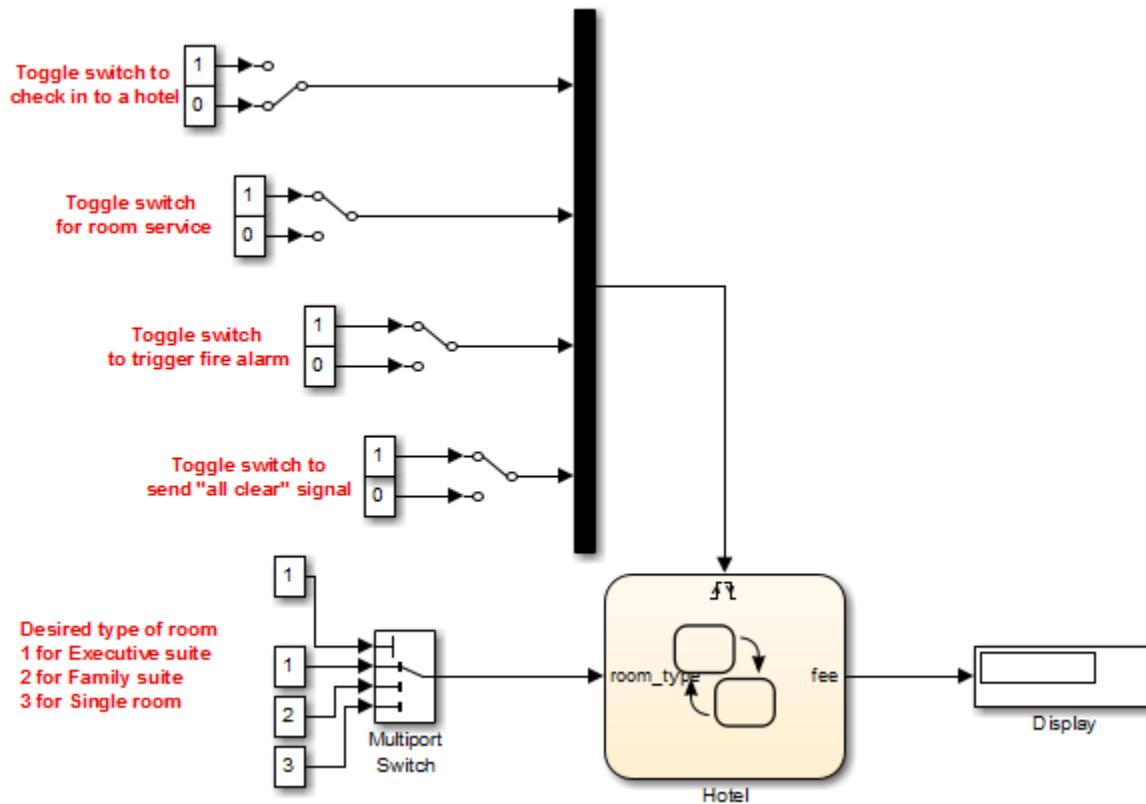

Block	Purpose	Rationale
Manual Switch	Enable toggling between two settings during simulation without having to pause or restart.	During simulation, you can interactively trigger the chart by sending one of these input events: <ul style="list-style-type: none"> • Checking in to a hotel • Calling room service • Triggering a fire alarm • Sending an all-clear signal after a fire alarm
Mux	Combine multiple input signals into a vector.	A chart can support multiple input events only if they connect to the trigger port of a chart as a vector of inputs.
Multiport Switch	Enable selection among more than two inputs.	This block provides a value for the chart input data <code>room_type</code> , where each room type corresponds to a number (1, 2, or 3). A Manual Switch block cannot support more than two inputs, but a Multiport Switch block can.
Display	Show up-to-date numerical value for input signal.	During simulation, any change to the chart output data <code>fee</code> appears in the display.

The Hotel chart contains graphical objects, such as states and history junctions, and nongraphical objects, such as conditions and condition actions.

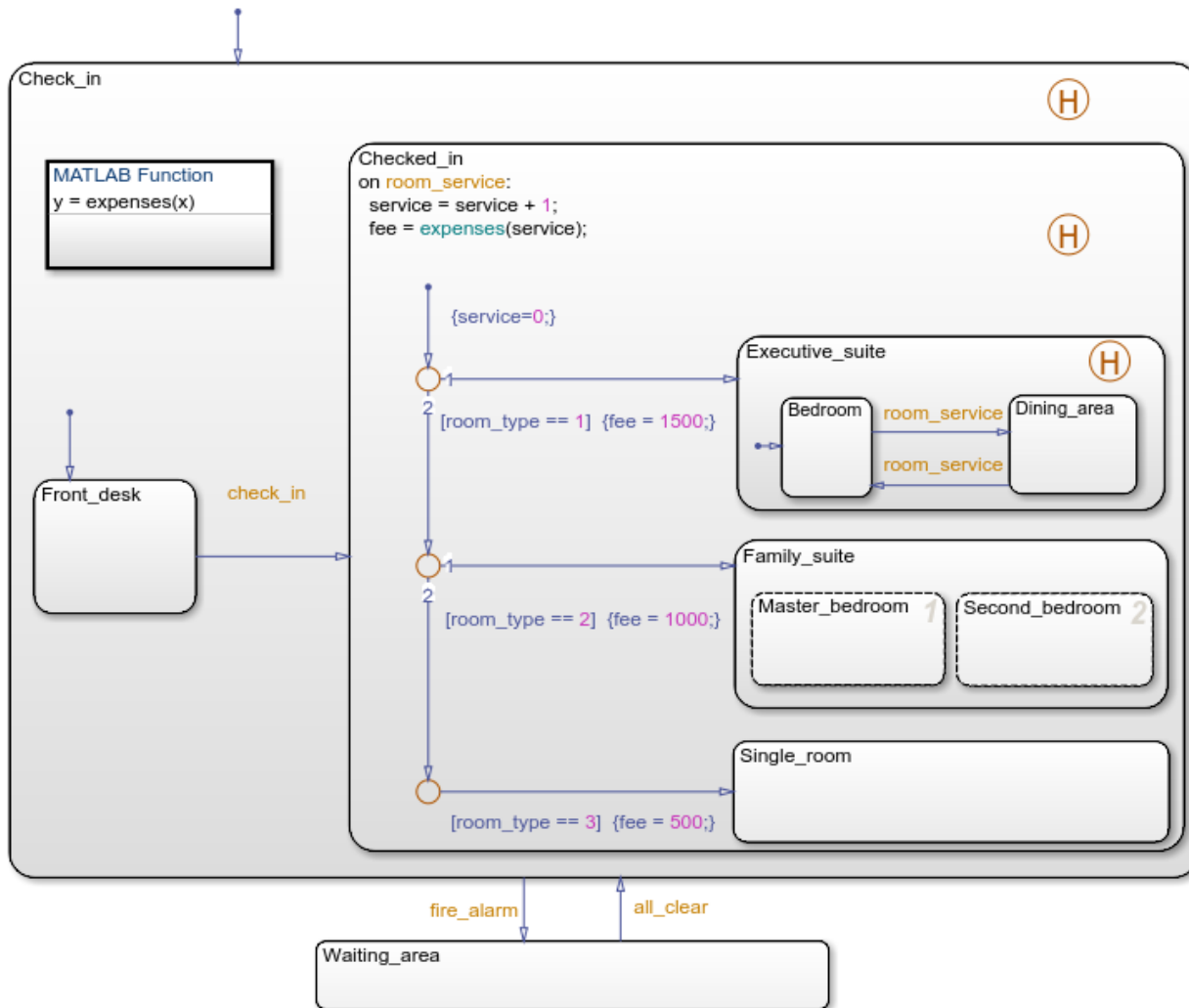

For a mapping of objects to their locations in the chart, see “Stateflow Objects” on page 3-2.

How the Chart Interacts with Simulink Blocks

Chart Initialization

When simulation starts, the chart wakes up and executes its default transitions because the **Execute (enter) Chart At Initialization** option is on (see “Execution of a Chart at Initialization” on page 3-21). Then the chart goes to sleep.

Note If this option is off, the chart does not wake up until you toggle one of the Manual Switch blocks. You can verify the setting for this option in the Chart properties dialog box. Right-click inside the top level of the chart and select **Properties** from the context menu.

Chart Interaction with Other Blocks

The chart wakes up again only when an *edge-triggered* input event occurs: `check_in`, `room_service`, `fire_alarm`, or `all_clear`. When you toggle a Manual Switch block for an input event during simulation, the chart detects a rising or falling edge and wakes up. While the chart is awake:

- The Multiport Switch block provides a value for the chart input data `room_type`.
- The Display block shows any change in value for the chart output data `fee`.

Chart Inactivity

After completing all possible phases of execution, the chart goes back to sleep.

Phases of Chart Execution

The following sections explain chart execution for each shaded region of the Hotel chart.

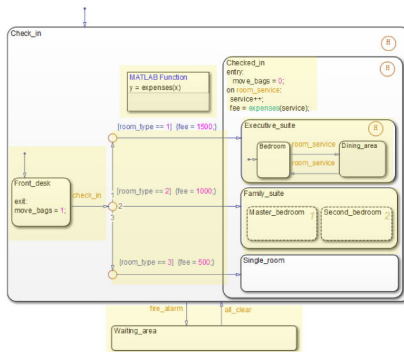

Phase: Chart Initialization

This section describes what happens in the `Front_desk` state just after the chart wakes up.

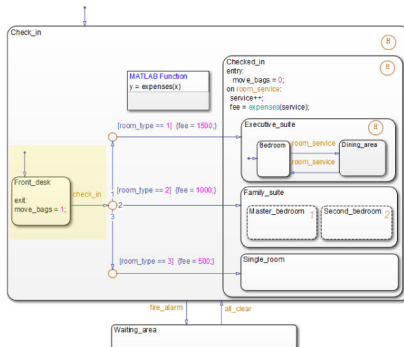

Stage	Hotel Scenario	Chart Behavior
1	Your first stop is at the front desk of the hotel.	At the chart level, the default transition to <code>Check_in</code> occurs, making that state active. Then, the default transition to <code>Front_desk</code> occurs, making that state active. For reference, see “Enter a Chart or State” on page 3-28.
2	You leave the front desk after checking in to the hotel.	The <code>check_in</code> event guards the outgoing transition from <code>Front_desk</code> . When the chart receives an event broadcast for <code>check_in</code> , the transition becomes valid. For reference, see “How Stateflow Charts Respond to Events” on page 3-51.
3	Just before you leave the front desk, you pick up your bags to move to your room.	Just before the transition occurs, the <code>exit</code> action of <code>Front_desk</code> sets the <code>move_bags</code> local data to 1. Then, <code>Front_desk</code> becomes inactive. For reference, see “Exit a State” on page 3-34.

Modeling Guidelines for Chart Initialization. The following guidelines apply to chart initialization.

Modeling Guideline	Why This Guideline Applies	Reference
Use exclusive (OR) decomposition when no two states at a level of the hierarchy can be active at the same time.	This guideline ensures proper chart execution. For example, <code>Check_in</code> and <code>Waiting_area</code> are exclusive (OR) states, because you cannot be inside and outside the hotel at the same time.	<ul style="list-style-type: none"> • “State Decomposition” on page 2-9 • “Specify Substate Decomposition” on page 4-7
Use a default transition to mark the first state to become active among exclusive (OR) states.	This guideline prevents state inconsistency errors during chart execution.	<ul style="list-style-type: none"> • “Default Transitions” on page 2-28 • “State Inconsistencies” on page 33-35
Use events, instead of conditions, to guard transitions that depend on occurrences without inherent numerical value.	Since you cannot easily quantify the numerical value of checking into a hotel, model such an occurrence as an event.	<ul style="list-style-type: none"> • “Activate a Stateflow Chart by Sending Input Events” on page 11-7

Modeling Guideline	Why This Guideline Applies	Reference
<p>Use an <code>exit</code> action to execute a statement once, just before a state becomes inactive.</p>	<p>Other types of state actions execute differently and do not apply:</p> <ul style="list-style-type: none"> • <code>Entry</code> actions execute once, just after a state becomes active. • <code>During</code> actions execute at every time step (except the first time step after a state becomes active). Execution continues as long as the chart remains in that state and no valid outgoing transitions exist. • <code>On <i>event_name</i></code> actions execute only after receiving an event broadcast. 	<ul style="list-style-type: none"> • “State Action Types” on page 13-2

Phase: Evaluation of Outgoing Transitions from a Single Junction

This section describes what happens after exiting the `Front_desk` state: the evaluation of a group of outgoing transitions from a single junction.

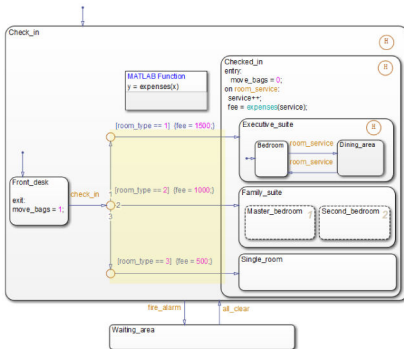

Stage	Hotel Scenario	Chart Behavior
1	<p>You can move to one of three types of rooms.</p>	<p>After the <code>check_in</code> event triggers a transition out of <code>Front_desk</code>, three transition paths are available based on the type of room you select with the Multiport Switch block. Transition testing occurs based on the priority you assign to each path.</p> <p>For reference, see “Order of Execution for a Set of Flow Charts” on page 3-56.</p>

Stage	Hotel Scenario	Chart Behavior
2	If you choose an executive suite, the base fee is 1500.	<p>If the <code>room_type</code> input data equals 1, the top transition is valid. If this condition is true, the condition action executes by setting the <code>fee</code> output data to 1500.</p> <hr/> <p>Note If the top transition is not valid, control flow backtracks to the central junction so that testing of the next transition can occur. This type of backtracking is intentional.</p> <p>To learn about <i>unintentional</i> backtracking and how to avoid it, see “Backtrack in Flow Charts” on page B-30 and “Best Practices for Creating Flow Charts” on page 5-2.</p>
3	If you choose a family suite, the base fee is 1000.	If <code>room_type</code> equals 2, the middle transition is valid. If this condition is true, the condition action executes by setting <code>fee</code> to 1000.
4	If you choose a single room, the base fee is 500.	If <code>room_type</code> equals 3, the bottom transition is valid. If this condition is true, the condition action executes by setting <code>fee</code> to 500.

What happens if `room_type` has a value other than 1, 2, or 3?

Because the Multiport Switch block outputs only 1, 2, or 3, `room_type` cannot have any other values. However, if `room_type` has a value other than 1, 2, or 3, the chart stays in the `Front_desk` state. This behavior applies because no transition path out of that state is valid.

Modeling Guidelines for Evaluation of Outgoing Transitions. The following guidelines apply to transition syntax.

Modeling Guideline	Why This Guideline Applies	Reference
Use conditions, instead of events, to guard transitions that depend on occurrences with numerical value.	Because you can quantify a type of hotel room numerically, express the choice of room type as a condition.	“Flow Charts in Stateflow” on page 5-2
Use condition actions instead of transition actions whenever possible.	<p>Condition actions execute as soon as the condition evaluates to true. Transition actions do not execute until after the transition path is complete, to a terminating junction or a state.</p> <p>Unless an execution delay is necessary, use condition actions instead of transition actions.</p>	“Transition Action Types” on page 13-7

Modeling Guideline	Why This Guideline Applies	Reference
Use explicit ordering to control the testing order of a group of outgoing transitions.	You can specify <i>explicit</i> or <i>implicit</i> ordering of transitions. By default, a chart uses explicit ordering. If you switch to implicit ordering, the transition testing order can change when graphical objects move.	“Transition Evaluation Order” on page 3-38

Phase: Execution of State Actions for a Superstate

This section describes what happens after you enter the Checked_in state, regardless of which substate becomes active.

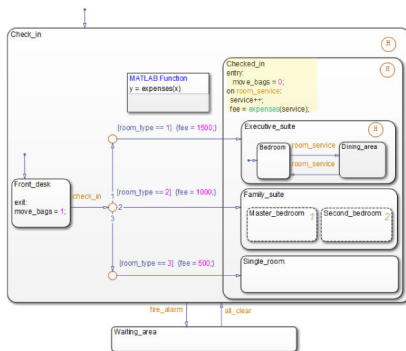

Stage	Hotel Scenario	Chart Behavior
1	After reaching your desired room, you finish moving your bags.	The entry action executes by setting the move_bags local data to 0.
2	If you order room service, your hotel bill increases by a constant amount.	<p>If the chart receives an event broadcast for room_service, these actions occur:</p> <ol style="list-style-type: none"> 1 The counter for the service local data increments by 1. 2 A function call to expenses occurs, which returns the value of the hotel bill stored by the fee output data. <p>For reference, see “How Stateflow Charts Respond to Events” on page 3-51.</p>

Modeling Guidelines for Execution of State Actions. The following guidelines apply to state actions.

Modeling Guideline	Why This Guideline Applies	Reference
Use an entry action to execute a statement once, right after a state becomes active.	Other types of state actions execute differently and do not apply: <ul style="list-style-type: none"> • During actions execute at every time step until there is a valid transition out of the state. 	“State Action Types” on page 13-2

Modeling Guideline	Why This Guideline Applies	Reference
Use an <i>On event_name</i> or <i>On message_name</i> action to execute a statement only after receiving an event broadcast or a message.	<ul style="list-style-type: none"> Exit actions execute once, just before a state becomes inactive. 	
Use a superstate to enclose multiple substates that share the same state actions.	This guideline enables reuse of state actions that apply to multiple substates. You write the state actions only <i>once</i> , instead of writing them separately in each substate.	“Create Substates and Superstates” on page 4-5

Phase: Function Call from a State Action

This part of the chart describes how you can perform function calls while a state is active.

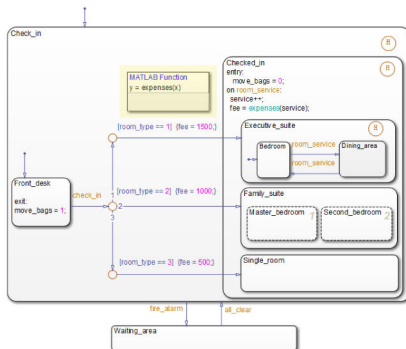

Stage	Hotel Scenario	Chart Behavior
1	Based on your room type and the total number of room service requests, you can track your hotel bill.	<p>expenses is a MATLAB function that takes the total number of room service requests as an input and returns the current hotel bill as an output.</p> <p>If you double-click the function box, you see this script in the function editor:</p> <pre>function y = expenses(x) if (room_type == 1) y = 1500 + (x*50); else if (room_type == 2) y = 1000 + (x*25); else y = 500 + (x*5); end end end</pre>

Modeling Guidelines for Function Calls. The following guidelines apply to function calls.

Modeling Guideline	Why This Guideline Applies	Reference
Use MATLAB functions for performing numerical computations in a chart.	MATLAB functions are better at handling numerical computations than graphical functions, truth tables, or Simulink functions.	"Reuse MATLAB Code by Defining MATLAB Functions" on page 29-2
Use descriptive names in function signatures.	Descriptive function names enhance readability of chart objects.	

Phase: Execution of State with Exclusive Substates

This part of the chart shows how a state with exclusive (OR) decomposition executes.

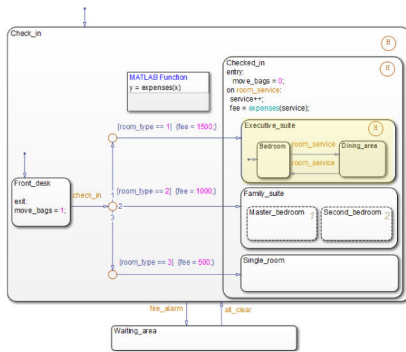

Stage	Hotel Scenario	Chart Behavior
1	When you reach the executive suite, you enter the bedroom first. Note The executive suite has separate bedroom and dining areas. Therefore, you can be in only one area of the suite at any time.	When the condition <code>room_type == 1</code> is true, the condition action <code>fee = 1500</code> executes. Completion of that transition path triggers these state initialization actions: <ol style="list-style-type: none"> 1 Checked_in becomes active and executes its entry action. 2 Executive_suite becomes active. 3 The default transition to Bedroom occurs, making that state active. For reference, see "Enter a Chart or State" on page 3-28.
2	When you order room service, you enter the dining area to eat.	When the <code>room_service</code> event occurs, the transition from Bedroom to Dining_area occurs.
3	When you want the food removed from the dining area, you order room service again and then return to the bedroom.	When the <code>room_service</code> event occurs, the transition from Dining_area to Bedroom occurs.

Stage	Hotel Scenario	Chart Behavior
4	If you leave the executive suite because of a fire alarm, you return to your previous room after the all-clear signal.	If a transition out of <code>Executive_suite</code> occurs, the history junction records the last active substate, <code>Bedroom</code> or <code>Dining_area</code> . For details on how this transition can occur, see “Phase: Events Guard Transitions Between States” on page 3-17.

Modeling Guidelines for Execution of Exclusive (OR) States. The following guidelines apply to exclusive (OR) states.

Modeling Guideline	Why This Guideline Applies	Reference
Use exclusive (OR) decomposition when no two states at that level of the hierarchy can be active at the same time.	This guideline ensures proper chart execution. For example, <code>Bedroom</code> and <code>Dining_area</code> are exclusive (OR) states, because you cannot be in both places at the same time.	<ul style="list-style-type: none"> • “State Decomposition” on page 2-9 • “Specify Substate Decomposition” on page 4-7
If reentry to a state with exclusive (OR) decomposition depends on the previously active substate, use a history junction. This type of junction records the active substate when the chart exits the state.	<p>If you do not record the previously active substate, the default transition occurs and the wrong substate can become active upon state reentry.</p> <p>For example, if you were eating when a fire alarm sounded, you would return to the bedroom instead of the dining room.</p>	<ul style="list-style-type: none"> • “History Junctions” on page 2-36

Phase: Execution of State with Parallel Substates

This part of the chart shows how a state with parallel (AND) decomposition executes.

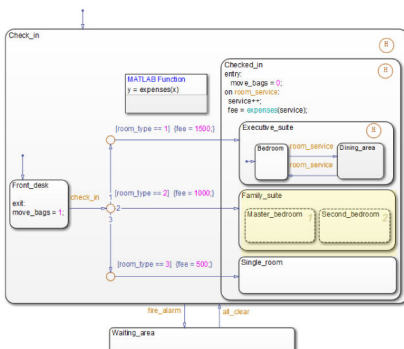

Stage	Hotel Scenario	Chart Behavior
1	When your family reaches the suite, family members can be in both bedrooms (for example, parents in the master bedroom and children in the second bedroom). A default room choice does not apply.	<p>When the condition <code>room_type == 2</code> is true, the condition action <code>fee = 1000</code> executes. Completion of that transition path triggers these state initialization actions:</p> <ol style="list-style-type: none"> 1 Checked_in becomes active and executes its entry action. 2 Family_suite becomes active. 3 The parallel states wake up in the order given by the number in the upper right corner of each state: <code>Master_bedroom</code>, then <code>Second_bedroom</code>. <p>How do I specify the order?</p> <p>To specify the order:</p> <ol style="list-style-type: none"> a Verify that the chart uses explicit ordering. <ul style="list-style-type: none"> In the Chart properties dialog box, select the User-specified state/transition execution order check box. b Right-click in a parallel state and select a number from the Execution Order menu. <p>For reference, see “Enter a Chart or State” on page 3-28.</p>
2	You can occupy both rooms at the same time.	<code>Master_bedroom</code> and <code>Second_bedroom</code> remain active at the same time.

Modeling Guidelines for Execution of Parallel (AND) States. The following guidelines apply to parallel (AND) states.

Modeling Guideline	Why This Guideline Applies	Reference
Use parallel (AND) decomposition when all states at that level of the hierarchy can be active at the same time.	This guideline ensures proper chart execution. For example, <code>Master_bedroom</code> and <code>Second_bedroom</code> are parallel states, because you can occupy both rooms at the same time.	<ul style="list-style-type: none"> • “State Decomposition” on page 2-9 • “Specify Substate Decomposition” on page 4-7
Use <i>no</i> history junctions in states with parallel (AND) decomposition.	This guideline prevents parsing errors. Since all parallel states at a level of hierarchy are active at the same time, history junctions have no meaning.	<ul style="list-style-type: none"> • “History Junctions” on page 2-36

Modeling Guideline	Why This Guideline Applies	Reference
Use explicit ordering to control the execution order of parallel (AND) states.	You can specify <i>explicit</i> or <i>implicit</i> ordering of parallel states. By default, a chart uses explicit ordering. If you switch to implicit ordering, the execution order can change when parallel states move.	<ul style="list-style-type: none"> “Execution Order for Parallel States” on page 3-58

Phase: Events Guard Transitions Between States

This part of the chart describes how events can guard transitions between exclusive (OR) states.

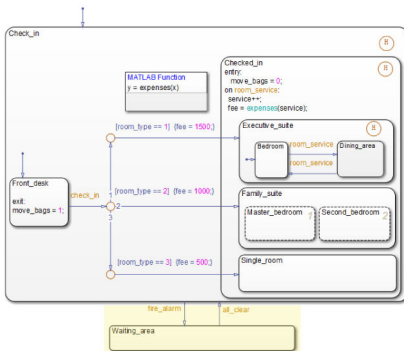

Stage	Hotel Scenario	Chart Behavior
1	If a fire alarm sounds, you leave the hotel and move to a waiting area outside.	<p>When the chart receives an event broadcast for <code>fire_alarm</code>, a transition occurs from a substate of <code>Check_in</code> to <code>Waiting_area</code>.</p> <p>How does this transition occur?</p> <p>Suppose that <code>Check_in</code>, <code>Checked_in</code>, <code>Executive_suite</code>, and <code>Dining_area</code> are active when the chart receives <code>fire_alarm</code>.</p> <ol style="list-style-type: none"> States become inactive in <i>ascending</i> order of hierarchy: <ol style="list-style-type: none"> <code>Dining_area</code> <code>Executive_suite</code> <code>Checked_in</code> <code>Check_in</code> <code>Waiting_area</code> becomes active.

Stage	Hotel Scenario	Chart Behavior
2	If an all-clear signal occurs, you can leave the waiting area and return to your previous location inside the hotel.	<p>When the chart receives an event broadcast for <code>all_clear</code>, a transition from <code>Waiting_area</code> to the previously active substate of <code>Check_in</code> occurs.</p> <p>The history junction at each level of hierarchy in <code>Check_in</code> enables the chart to remember which substate was previously active before the transition to <code>Waiting_area</code> occurred.</p> <p>How does this transition occur?</p> <p>Suppose that <code>Check_in</code>, <code>Checked_in</code>, <code>Executive_suite</code>, and <code>Dining_area</code> were active when the chart received <code>fire_alarm</code>.</p> <ol style="list-style-type: none"> 1 <code>Waiting_area</code> becomes inactive. 2 States become active in <i>descending</i> order of hierarchy: <ol style="list-style-type: none"> a <code>Check_in</code> b <code>Checked_in</code> (The default transition does not apply.) c <code>Executive_suite</code> d <code>Dining_area</code> (The default transition does not apply.)

Modeling Guidelines for Guarding Transitions. The following guideline discusses the use of events versus conditions.

Modeling Guideline	Why This Guideline Applies	Reference
Use events, instead of conditions, to guard transitions that depend on occurrences without numerical value.	Because you cannot easily quantify the numerical value of a fire alarm or an all-clear signal, model such an occurrence as an event.	"Activate a Stateflow Chart by Sending Input Events" on page 11-7

Modeling Guidelines for Stateflow Charts

Use these guidelines to efficiently model charts with events, states, and transitions.

Use signals of the same data type for input events

When you use multiple input events to trigger a chart, verify that all input signals use the same data type. Otherwise, simulation stops and an error message appears. For more information, see “Data Types Allowed for Input Events” on page 11-9.

Use a default transition to mark the first state to become active among exclusive (OR) states

This guideline prevents state inconsistency errors during chart execution.

Use condition actions instead of transition actions whenever possible

Condition actions execute as soon as the condition evaluates to true. Transition actions do not execute until after the transition path is complete, to a terminating junction or a state.

Unless an execution delay is necessary, use condition actions instead of transition actions.

Use explicit ordering to control the testing order of a group of outgoing transitions

You can specify *explicit* or *implicit* ordering of transitions. By default, a chart uses explicit ordering. If you switch to implicit ordering, the transition testing order can change when graphical objects move.

Verify intended backtracking behavior in flow charts

If your chart contains unintended backtracking behavior, a warning message appears with instructions on how to avoid that problem. For more information, see “Best Practices for Creating Flow Charts” on page 5-2.

Use a superstate to enclose substates that share the same state actions

When you have multiple exclusive (OR) states that perform the same state actions, group these states in a superstate and define state actions at that level.

This guideline enables reuse of state actions that apply to multiple substates. You write the state actions only once, instead of writing them separately in each substate.

Note You cannot use boxes for this purpose because boxes do not support state actions.

Use MATLAB functions for performing numerical computations in a chart

MATLAB functions are better at handling numerical computations than graphical functions, truth tables, or Simulink functions.

Use descriptive names in function signatures

Descriptive function names enhance readability of chart objects.

Use history junctions to record state history

If reentry to a state with exclusive (OR) decomposition depends on the previously active substate, use a history junction. This type of junction records the active substate when the chart exits the state. If you do not record the previously active substate, the default transition occurs and the wrong substate can become active upon state reentry.

Do not use history junctions in states with parallel (AND) decomposition

This guideline prevents parsing errors. Since all parallel states at a level of hierarchy are active at the same time, history junctions have no meaning.

Use explicit ordering to control the execution order of parallel (AND) states

You can specify *explicit* or *implicit* ordering of parallel states. By default, a chart uses explicit ordering. If you switch to implicit ordering, the execution order can change when parallel states move.

Types of Chart Execution

Life Cycle of a Stateflow Chart

Stateflow charts go through several stages of execution:

Stage	Description
Inactive	Chart has no active states
Active	Chart has active states
Sleeping	Chart has active states, but no events to process

When a Simulink model first triggers a Stateflow chart, the chart is inactive and has no active states. After the chart executes and completely processes its initial trigger event from the Simulink model, it transfers control back to the model and goes to sleep. At the next Simulink trigger event, the chart changes from the sleeping to active stage.

See “Use Events to Execute Charts” on page 3-51.

Execution of an Inactive Chart

When a chart is inactive and first triggered by an event from a Simulink model, it first executes its set of default flow charts (see “Order of Execution for a Set of Flow Charts” on page 3-56). If this action does not cause an entry into a state and the chart has parallel decomposition, then each parallel state becomes active (see “Enter a Chart or State” on page 3-28).

If executing the default flow paths does not cause state entry, a state inconsistency error occurs.

Execution of an Active Chart

After a chart has been triggered the first time by the Simulink model, it is an active chart. When the chart receives another event from the model, it executes again as an active chart. If the chart has no states, each execution is equivalent to initializing a chart. Otherwise, the active substates execute. Parallel states execute in the same order that they become active.

Execution of a Chart at Initialization

By default, the first time a chart wakes up, it executes the default transition paths. At this time, the chart can access inputs, write to outputs, and broadcast events.

If you want your chart to begin executing from a known configuration, you can enable the **Execute (enter) Chart At Initialization** chart property. When you turn on this option, the state configuration of a chart initializes at time 0 instead of the first occurrence of an input event. The default transition paths of the chart execute during the model initialization phase at time 0, corresponding to the `mdlInitializeConditions()` phase for S-functions. For more information, see “Execute (Enter) Chart at Initialization” on page 25-5.

Note If an output of this chart connects to a SimEvents® block, do not select this check box. To learn more about using Stateflow charts and SimEvents blocks together in a model, see the SimEvents documentation.

Due to the transient nature of the initialization phase, do not perform certain actions in the default transition paths of the chart — and associated state entry actions — which execute at initialization. Follow these guidelines:

- Do not access chart input data, because blocks connected to chart input ports might not have initialized their outputs yet.
- Do not call exported graphical functions from other charts, because those charts might not have initialized yet.
- Do not broadcast function-call output events, because the triggered subsystems might not have initialized yet.

You can control the level of diagnostic action for invalid access to chart input data in the **Diagnostics** > **Stateflow** pane of the Configuration Parameters dialog box. For more information, see the documentation for the “Invalid input data access in chart initialization” (Simulink) diagnostic.

Execute at initialization is ignored in Stateflow charts that do not contain states.

See Also

More About

- “Execution of a Stateflow Chart” on page 3-23
- “Exit a State” on page 3-34
- “Evaluate Transitions” on page 3-37

Execution of a Stateflow Chart

When a Stateflow chart wakes up, the chart follows a workflow and executes actions. A Stateflow chart wakes up:

- At each time step according to the Simulink solver.
- When the Stateflow chart receives an event.

When a chart wakes up for the first time, the chart is initialized and becomes active. See “Chart Entry” on page 3-30. Once the chart is active but with no more actions to take, the chart goes to sleep until it is triggered by a new time step or an event.

Workflow for Stateflow Chart Execution

This flow chart shows the progression of events that Stateflow takes for executing a chart or state. In this flow chart, the current state refers to the state in which a decision or a process is taking place.

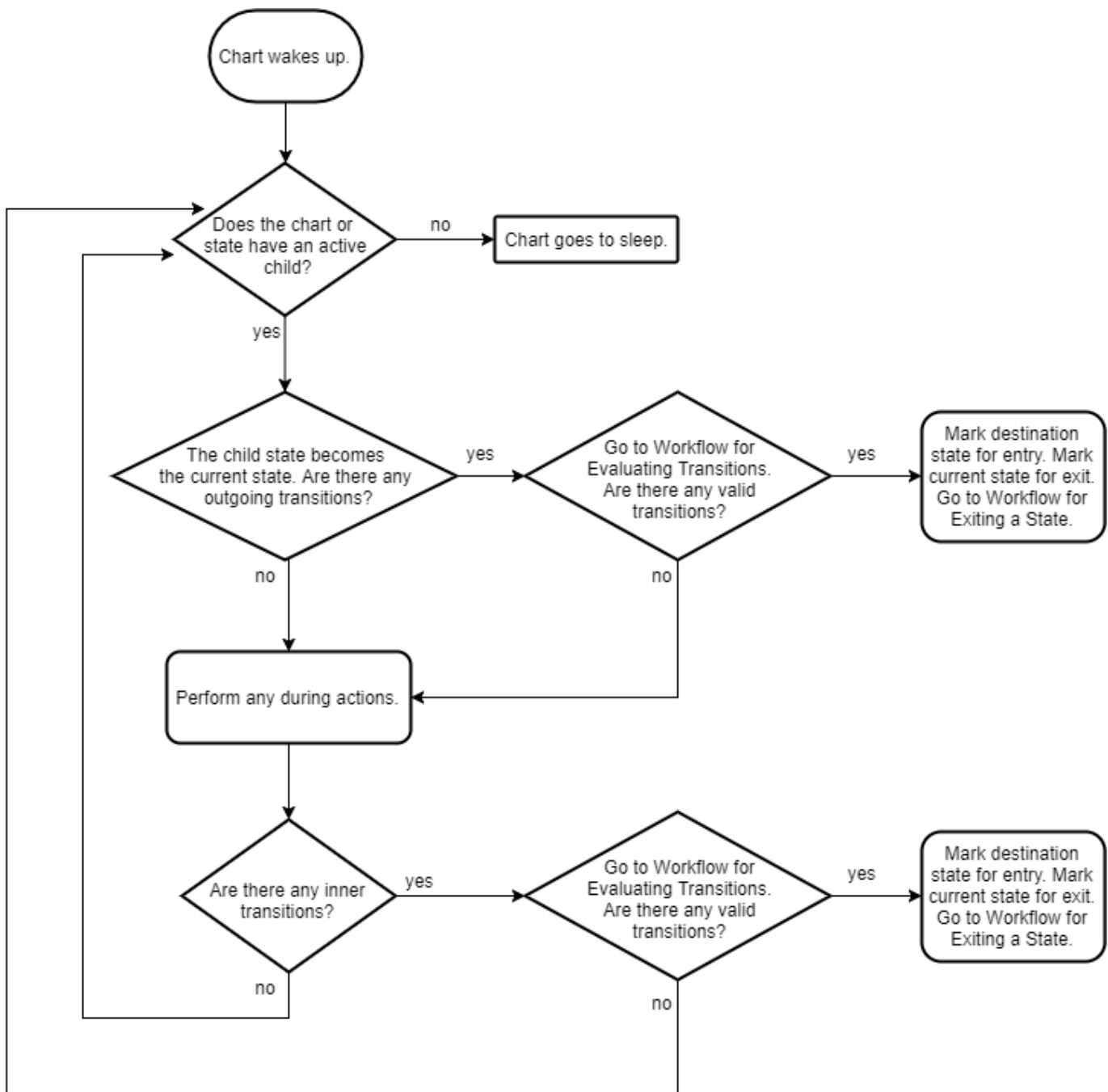

During Actions

During actions for a state execute when:

- The state is active, a new time step occurs, and no valid transition to another state is available.
- The state is active, an event occurs, and no valid transition to another state is available.

During actions are preceded by the prefix `during` or `du`, and then followed by a required colon (`:`), followed by one or more actions. Separate multiple actions with a carriage return, semicolon (`;`), or a comma (`,`). If you do not specify the state action type explicitly for a statement, the chart treats that statement as an entry,during action.

A state performs its `during` actions (if specified) when the chart wakes up. The preceding flow chart depicts the process of state execution and shows when `during` actions occur.

If your Stateflow chart does not contain states, each time the chart is executed, Stateflow always evaluates the default transition path.

Outgoing Transition

Stateflow marks outgoing transitions for evaluation as a part of the execution of a Stateflow chart. Once an outgoing transition is marked for evaluation, follow the “Workflow for Evaluating Transitions” on page 3-38. For more information about how Stateflow evaluates outgoing transitions, see “Evaluate Transitions” on page 3-37.

Inner Transitions

Stateflow marks inner transitions for evaluation as a part of the execution of a Stateflow chart. Once an inner transition is marked for evaluation, follow the “Workflow for Evaluating Transitions” on page 3-38. For more information about how Stateflow evaluates inner transitions, see “Evaluate Transitions” on page 3-37.

Chart Execution with a Valid Transition

In this example, the Stateflow chart is initialized and the entry actions are performed for StateA and StateA1. A new time step occurs and the chart wakes up.

At this time step, $x = 5$, $y = 2$, and $z = 0$.

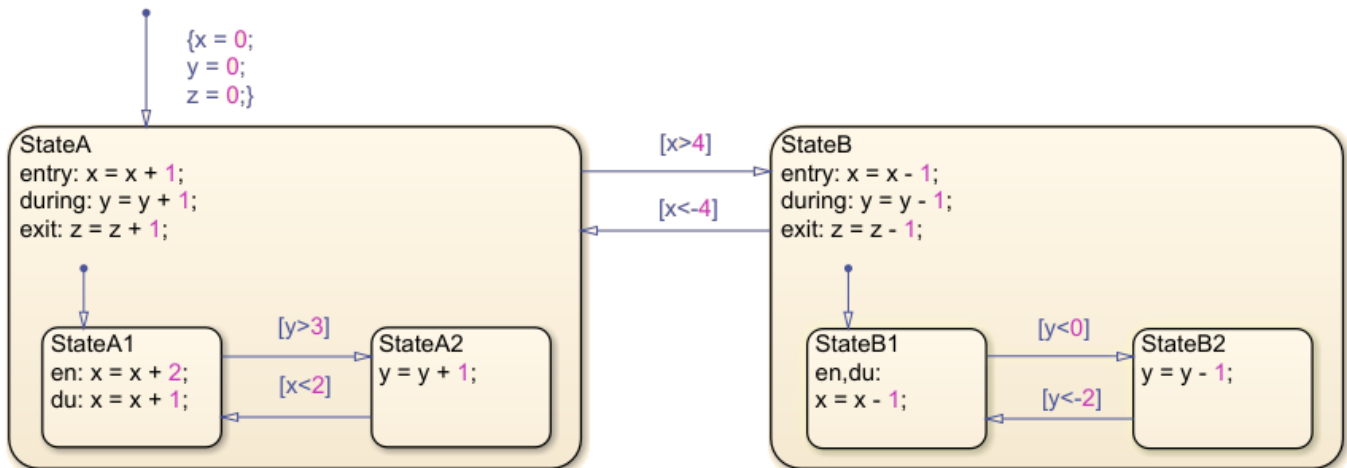

By following the “Workflow for Stateflow Chart Execution” on page 3-23, the execution steps for chart execution are in this order:

- 1 The chart has an active substate, StateA.
- 2 StateA has an outgoing transition to StateB. By following the “Workflow for Evaluating Transitions” on page 3-38, the transition is determined to be valid.
- 3 StateB is marked for entry and StateA is marked for exit.

To complete the time step, follow the “Workflow for Exiting a State” on page 3-34 for StateA and the “Workflow for Entering a Chart or State” on page 3-28 for StateB.

Chart Execution Without a Valid Transition

In this example, the Stateflow chart is initialized and the entry actions are performed for StateA and StateA1. A new time step occurs and the chart wakes up.

At this time step, $x = 3$, $y = 0$, and $z = 0$.

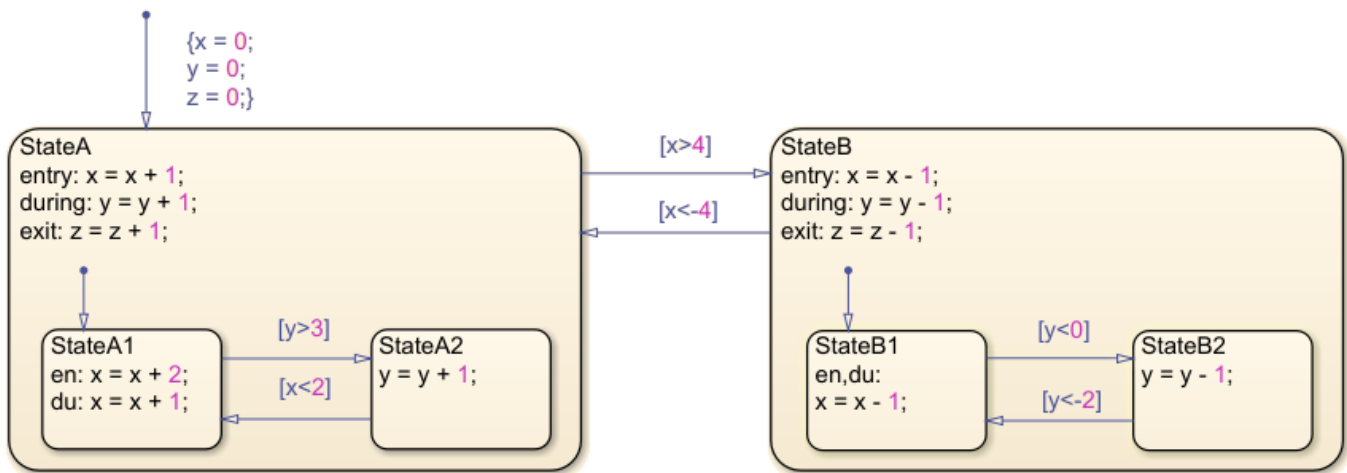

By following the “Workflow for Stateflow Chart Execution” on page 3-23 until the chart goes to sleep, the execution steps for chart execution are in this order:

- 1 The chart has an active substate, StateA.
- 2 StateA has an outgoing transition to StateB. By following the “Workflow for Evaluating Transitions” on page 3-38, the transition is determined to be invalid.
- 3 Perform the during actions for StateA. Now $y = 1$.
- 4 StateA does not have any inner transitions.
- 5 The active substate of StateA is StateA1.
- 6 StateA1 has an outgoing transition to StateA2. By following the “Workflow for Evaluating Transitions” on page 3-38, the transition is determined to be invalid.
- 7 Perform the during actions for StateA1. Now $x = 4$.
- 8 StateA1 does not have any active substates.
- 9 The chart goes to sleep.

Steps 1 through 9 take place in the second time step.

See Also

More About

- “Enter a Chart or State” on page 3-28
- “Exit a State” on page 3-34
- “Evaluate Transitions” on page 3-37

Enter a Chart or State

Chart and state entry occurs when:

- A chart is activated for the first time. This is called chart initialization.
- A valid transition into a state exists. See “Evaluate Transitions” on page 3-37.

Workflow for Entering a Chart or State

This flow chart shows the progression of events that Stateflow takes for entry into a chart or a state. In this flow chart, the current state refers to the state in which a decision or a process is taking place.

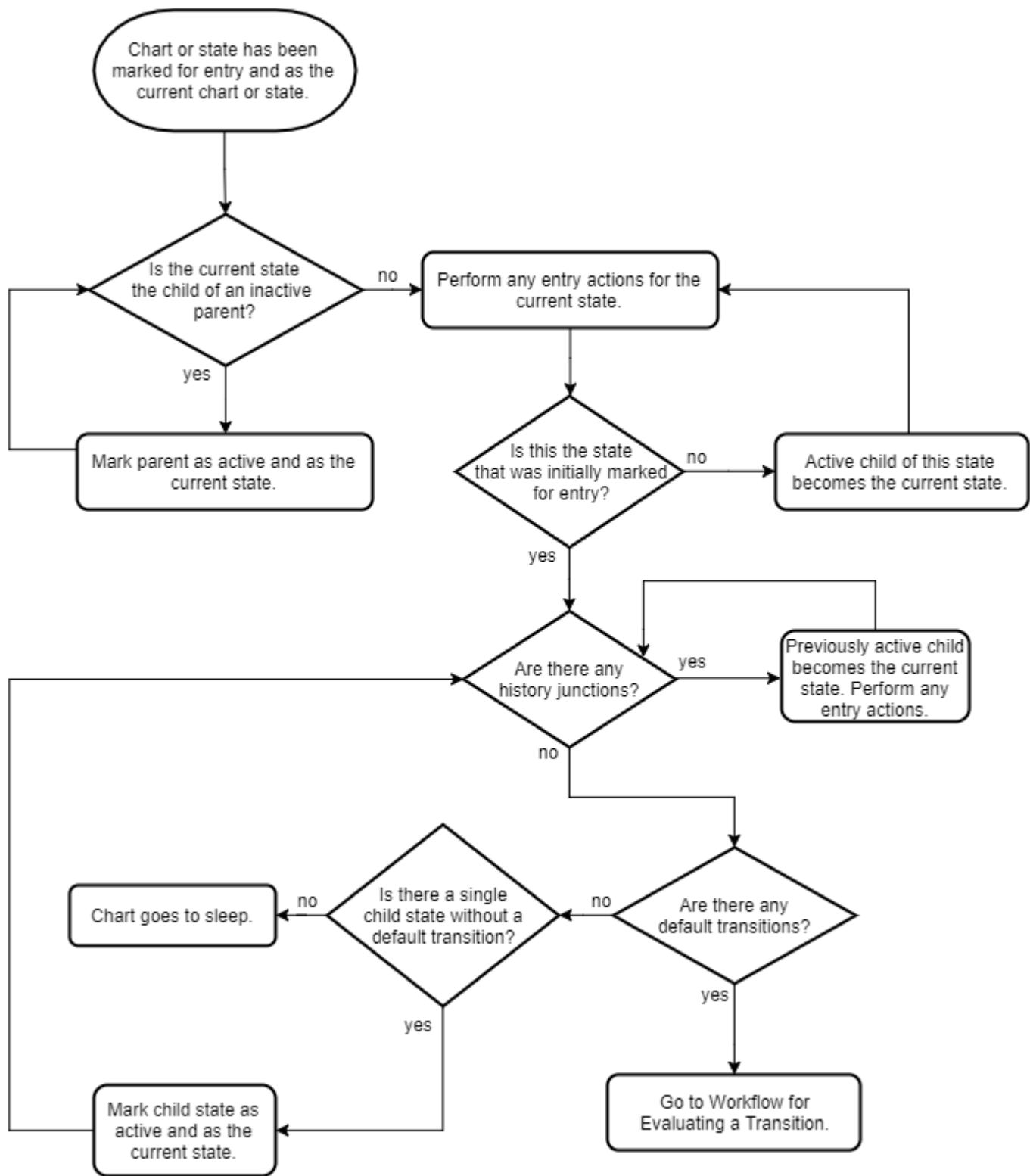

Chart Entry

The first time that your Stateflow chart becomes active is called initialization. When initialization of your chart occurs, the chart is entered and Stateflow executes any default transitions for exclusive (OR) states. If the states at the top level of your chart are parallel (AND), they become active based on their order number.

If you want your chart to take any default transitions before time $t = 0$, in the Chart Properties dialog box, select the **Execute (enter) Chart At Initialization** check box. This option causes the Stateflow chart to initialize at the same time as Simulink initialization. The default transition paths of the chart then execute during the model initialization phase.

State Entry

When a state is marked for entry, entry actions for a state execute. Once your chart is active and has gone through initialization, the top-level state becomes active. A state is marked for entry in one of these ways:

- An incoming transition crosses state boundaries.
- An incoming transition ends at the state boundary.
- The state is a parallel state child of an active state.

Entry Actions

Entry actions are preceded by the prefix `entry` or `en` for short, followed by a required colon (`:`), and then followed by one or more actions. You separate multiple actions by using a carriage return, a semicolon (`;`), or a comma (`,`). If you do not specify the state action type explicitly for a statement, the chart treats that statement as an `entry,during` action.

Enter a Stateflow Chart

In this example, the first time the chart becomes active, chart initialization occurs.

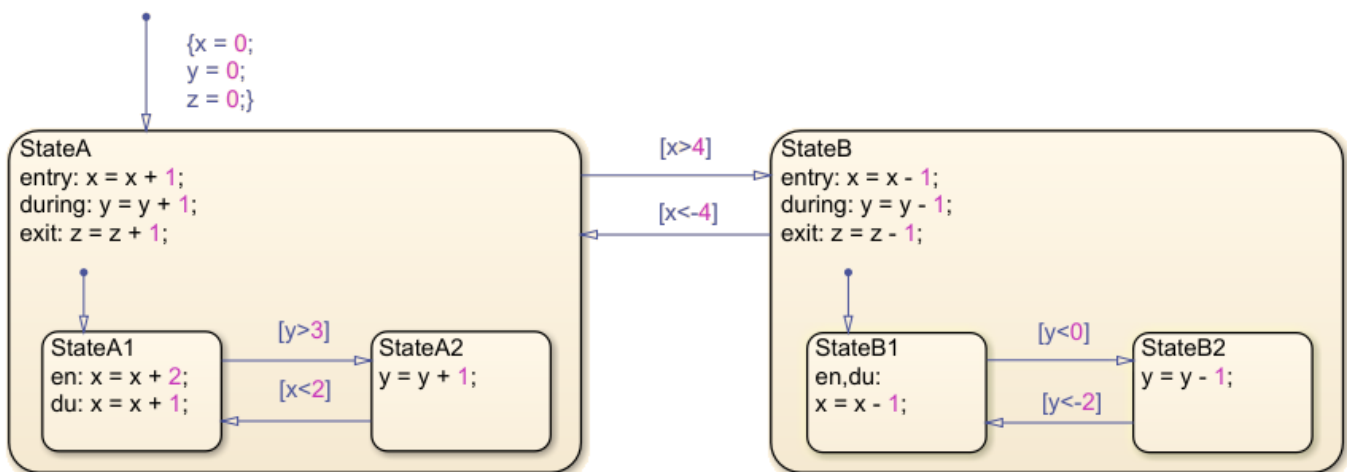

By following the “Workflow for Entering a Chart or State” on page 3-28 until the chart goes to sleep, the steps for chart initialization are in this order:

- 1 The default transition actions are executed, and $x = 0$, $y = 0$, and $z = 0$.
- 2 StateA is marked for entry.
- 3 StateA is not a substate of an inactive parent. Perform the entry actions for StateA. Now $x = 1$.
- 4 StateA is the state that was initially marked for entry.
- 5 StateA does not contain any history junctions.
- 6 There is a default transition to the substate, StateA1. Go to the Evaluate Transitions flow chart.
- 7 By following the Evaluate Transitions flow chart, mark StateA1 for entry. Go to the Exit Actions flow chart.
- 8 The current state, StateA, is a superstate of the destination state, StateA1. Return to the Entry Actions flow chart.
- 9 StateA1 is not a substate of an inactive parent. Perform entry actions for StateA1. Now $x = 3$.
- 10 StateA1 is the state that was initially marked for entry.
- 11 StateA1 does not contain any history junctions.
- 12 StateA1 does not contain any default transitions.
- 13 StateA1 does not contain any single substates.
- 14 The chart goes to sleep.

Steps 1 through 14 take place in the initial time step. This completes the chart initialization process.

Entering a State by Using History Junctions

If you want your Stateflow chart to remember and return to a substate that was previously active, regardless of a default transition, use a history junction. Placing a history junction within a state overrides the default transition leading to exclusive (OR) substates. After placing a history junction within a state, upon entry, your Stateflow chart remembers and enters the previously active substate. The history junction applies only to the level of the hierarchy in which it appears.

In this example, a light can be on or off. These options are indicated by the states `Power_on` and `Power_off`. The options are controlled by the input events `switch_on` and `switch_off`. When the light is on, it can be dim or bright. These options are indicated by the states `Low` and `High` and are controlled by the input events `switch_low` and `switch_high`.

Initially, the chart is asleep. The state `Power_off` is active. When the state `Power_on` was last active, `High` was the previously active substate. The event `switch_on` occurs and the state `Power_on` is marked for entry. At this time $p = 0$.

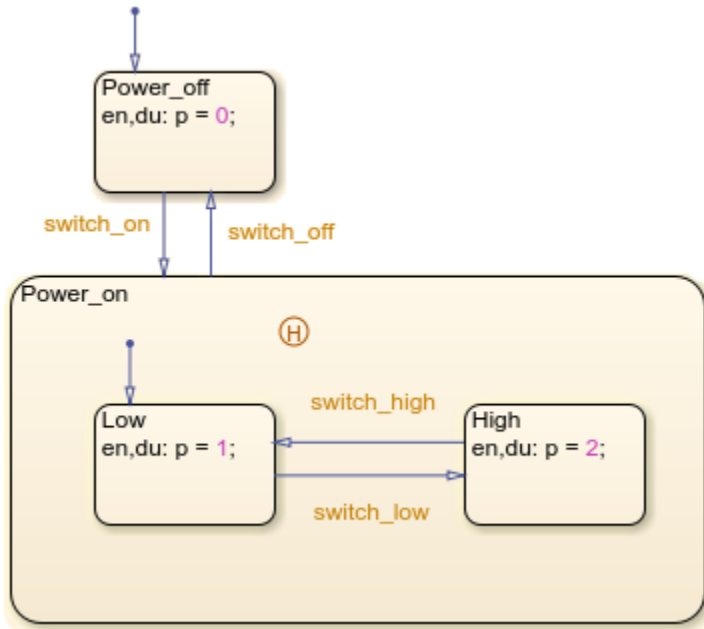

By following the “Workflow for Entering a Chart or State” on page 3-28 until the chart goes to sleep, the execution steps for entering the state `Power_on` are in this order:

- 1 `Power_on` is not the child of an inactive parent.
- 2 There are no entry actions for `Power_on`.
- 3 `Power_on` is the state that was initially marked for entry.
- 4 There are history junctions in `Power_on`.
- 5 `High` was the previously active substate. Now $p = 2$.
- 6 `High` does not contain any history junctions.
- 7 `High` does not contain any default transitions.
- 8 `High` does not contain any single substates.
- 9 The chart goes to sleep.

This completes the entry actions for `Power_on` and `High`.

Entering a State by Using Supertransitions

A supertransition is a transition between different levels in a chart. A supertransition can be between a state in a top-level chart and a state in one of its subcharts, or between states residing in different subcharts at the same or different levels in a chart. You can create supertransitions that span any number of levels in your chart.

When a state is entered through a supertransition, before the entry actions for the final destination are executed, its superstates must be marked active and their entry actions must be executed. In this example, `StateB1` has been marked for entry from `StateA2`. At this point, $x = 5$, $y = 5$, and $z = 1$.

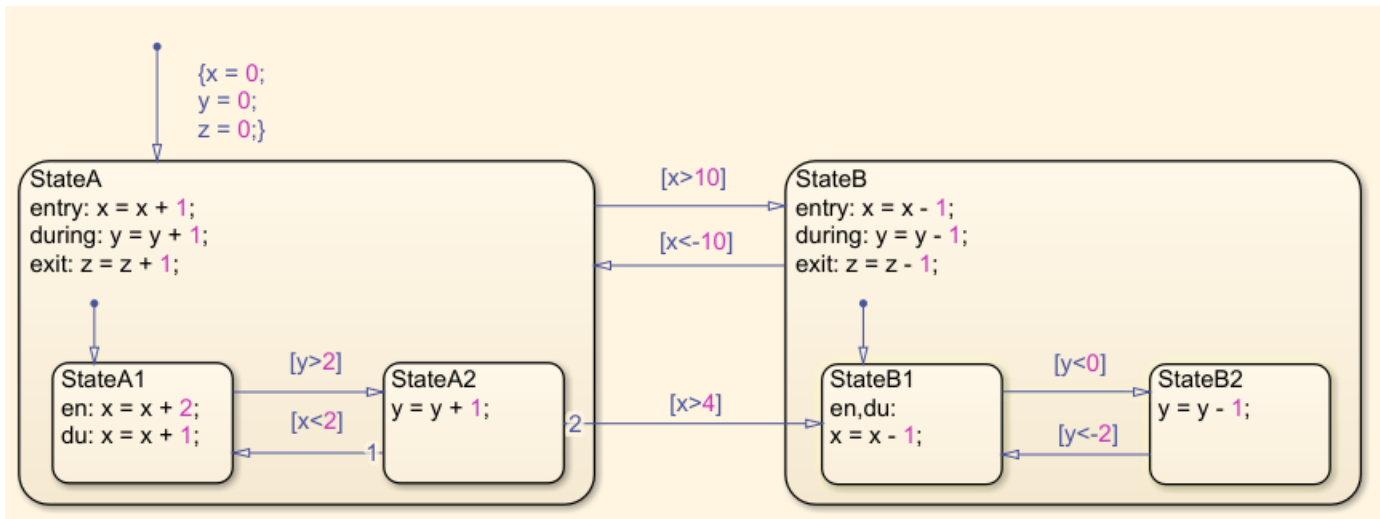

By following the “Workflow for Entering a Chart or State” on page 3-28 until the chart goes to sleep, the execution steps for entering the state **StateB1** are in this order:

- 1 **StateB1** is the substate of an inactive parent (**StateB**).
- 2 **StateB** is marked as active.
- 3 **StateB** is not the substate of an inactive parent.
- 4 Perform the entry actions for **StateB**. Now `x = 4`.
- 5 **StateB** is not the state that was initially marked for entry.
- 6 Perform the entry actions for **StateB1**. Now `x = 3`.
- 7 **StateB1** is the state that was initially marked for entry.
- 8 **StateB1** has no history junctions.
- 9 **StateB1** does not contain any default transitions.
- 10 **StateB1** does not contain any single substates.
- 11 The chart goes to sleep.

This completes the entry actions for **StateB** and **StateB1**.

See Also

More About

- “Execution of a Stateflow Chart” on page 3-23
- “Exit a State” on page 3-34
- “Evaluate Transitions” on page 3-37

Exit a State

When there is a valid transition out of a state, that state is marked for exit. A state is marked for exit in one of these ways:

- The outgoing transition originates at the state boundary.
- The outgoing transition crosses the state boundary.
- The destination state is a parallel state child of an activated state.

Workflow for Exiting a State

This flow chart shows the progression of events in Stateflow for exiting a state. In this flow chart, the current state refers to the state in which a decision or a process is taking place.

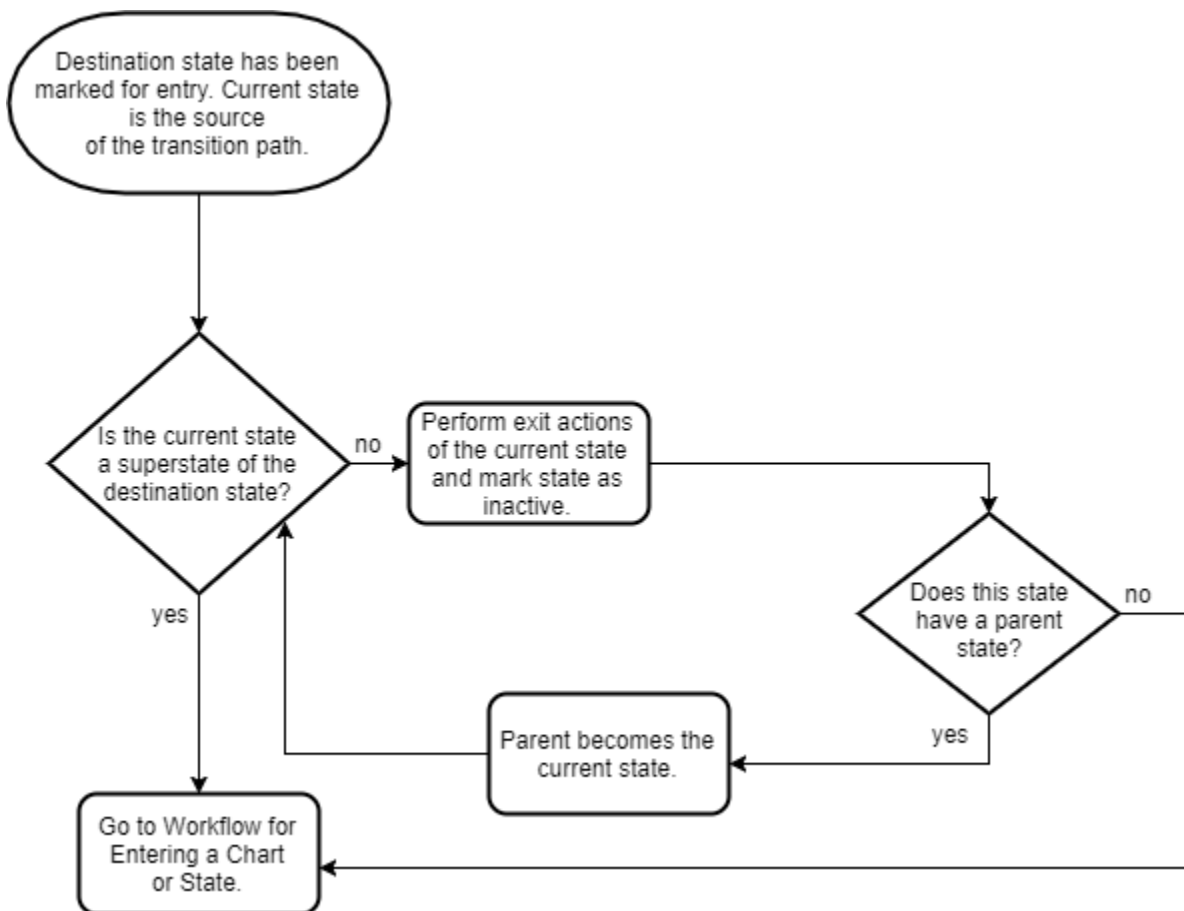

Exit Actions

Exit actions for a state execute when the state is active and a valid transition from the state exists. A state performs its exit actions before becoming inactive.

Exit actions are preceded by the prefix `exit` or `ex`, followed by a required colon (:), and then followed by one or more actions. Separate multiple actions with a carriage return, semicolon (;), or a comma (,).

Exit a State Example

In this example, the Stateflow chart is initialized and the entry actions are performed for `StateA` and `StateA1`. For this chart, the during actions for this chart have occurred twice. A new time step occurs, and then the chart wakes up.

By following the “Workflow for Stateflow Chart Execution” on page 3-23 and the “Workflow for Evaluating Transitions” on page 3-38, `StateB` has been marked for entry. `StateA` is the source of the transition. At this time step $x = 5$, $y = 2$, and $z = 0$.

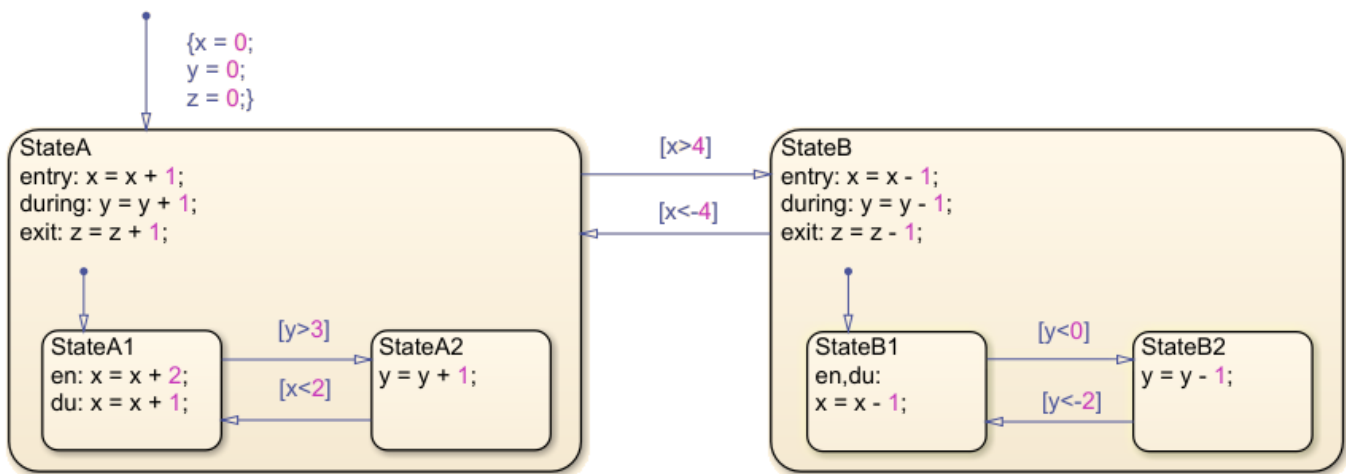

By following the flow chart for state exit actions until the chart goes to sleep, the execution steps for this chart are in this order:

- 1 `StateA` is not a superstate of `StateB`.
- 2 Perform the exit actions of `StateA` and mark `StateA` as inactive. Now $z = 1$.
- 3 `StateA` does not have a parent state.
- 4 Go to “Entry Actions” on page 3-30.

These steps complete the exit workflow for `StateA`. However, the chart is not yet asleep.

Perform the “Workflow for Entering a Chart or State” on page 3-28 for `StateB` to complete the time step.

Exit a State by Using Supertransitions

A supertransition is a transition between different levels in a chart. A supertransition can be between a state in a top-level chart and a state in one of its substates, or between states residing in different substates. You can create supertransitions that span any number of levels in your chart.

When a state is exited through a supertransition, after the exit actions for the source of the transition are executed, its superstates are marked inactive and exit actions of the superstates are executed. In this example, `StateA2` is marked for exit and `StateB1` is marked for entry. At this point, $x = 5$, $y = 5$, and $z = 0$.

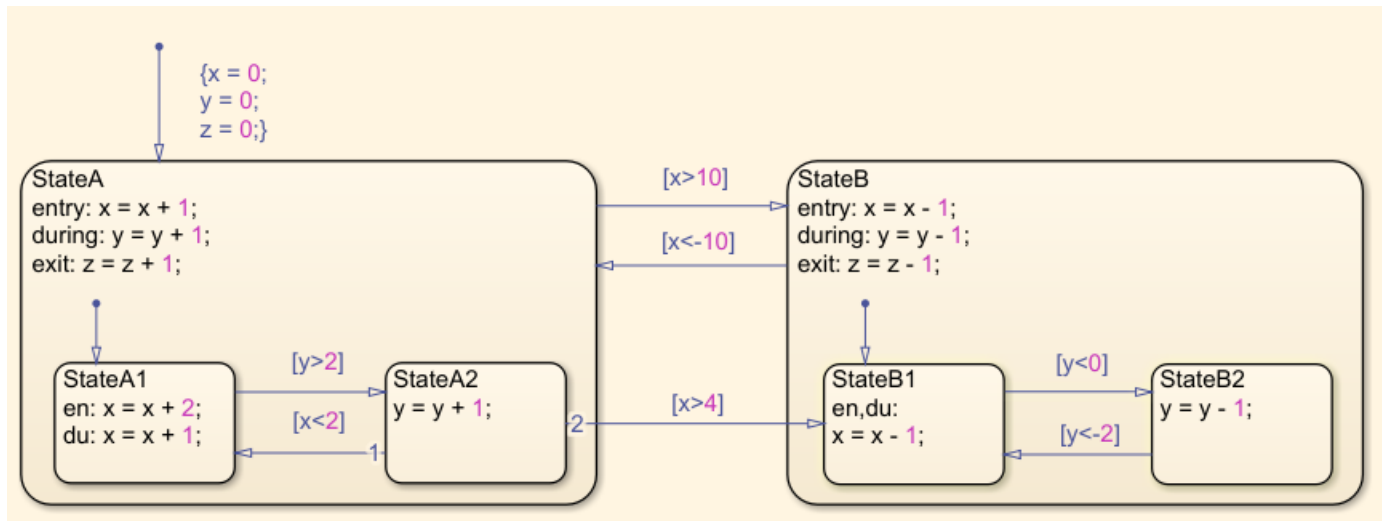

By following the “Workflow for Entering a Chart or State” on page 3-28 until the chart goes to sleep, the execution steps for exiting the state StateA2 are in this order:

- 1 StateA2 is not a superstate of the destination state (StateB1).
- 2 Perform the exit actions for StateA2 and mark StateA2 as inactive.
- 3 StateA2 does have a parent state, StateA.
- 4 StateA is not a superstate of the destination state (StateB1).
- 5 Perform the exit actions for StateA, and mark StateA as inactive.
- 6 StateA does not have a parent state.

These actions complete the exit workflow for StateA2 and StateA. However, the chart is not yet asleep.

Perform the “Workflow for Entering a Chart or State” on page 3-28 for StateB and StateB1 to complete the time step.

See Also

More About

- “Execution of a Stateflow Chart” on page 3-23
- “Enter a Chart or State” on page 3-28
- “Evaluate Transitions” on page 3-37

Evaluate Transitions

Stateflow uses transitions in charts to move from one exclusive (OR) state to another exclusive (OR) state. For the entry and execution workflows of chart execution, Stateflow evaluates transitions to determine if they are valid. A valid transition is a transition whose condition labels are true and whose path ends at a state. If a transition is valid, Stateflow exits from the source state and enters the destination state. To learn about when evaluation occurs during the execution and entry workflows, see “Execution of a Stateflow Chart” on page 3-23 and “Enter a Chart or State” on page 3-28.

Workflow for Evaluating Transitions

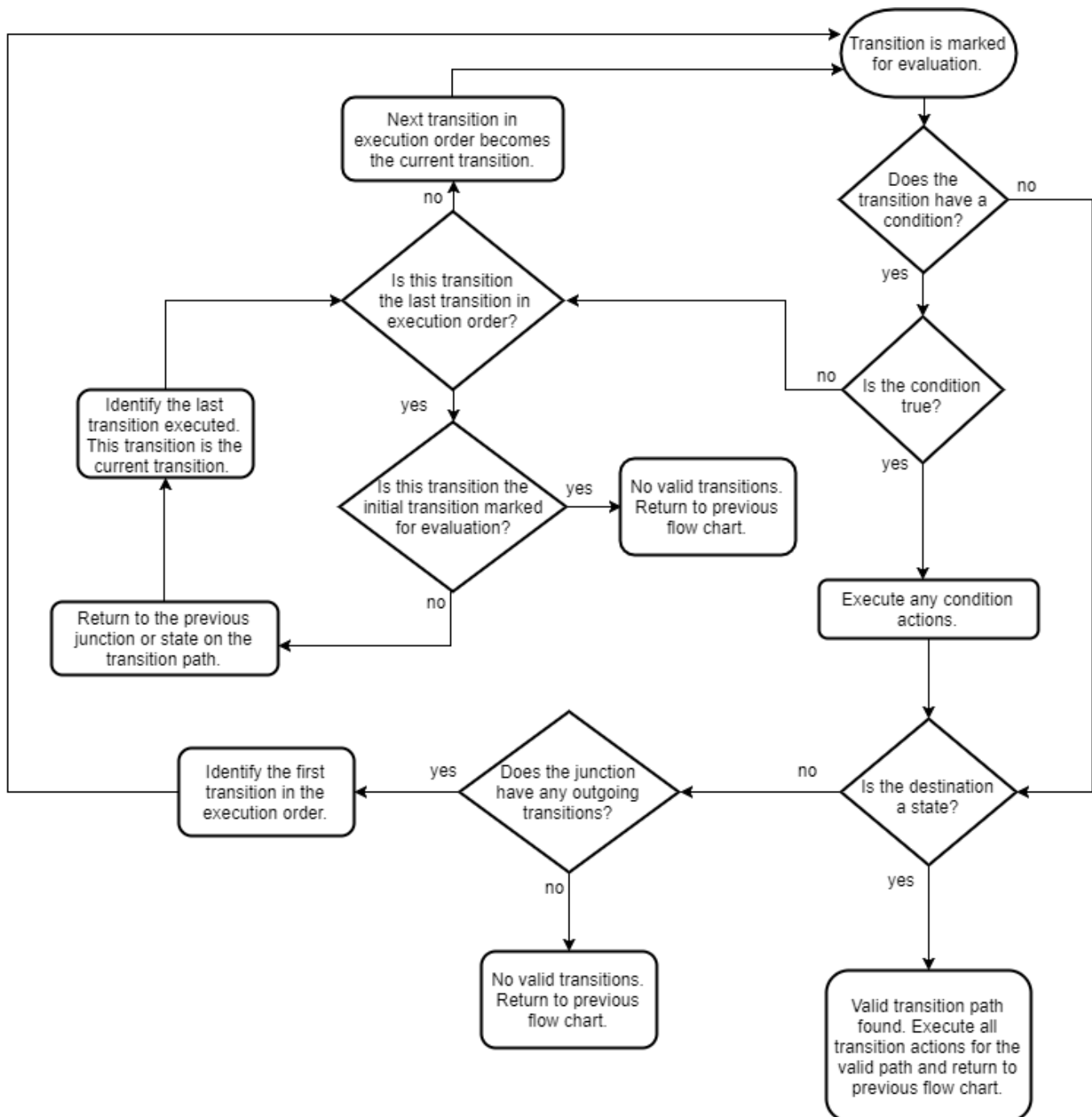

Transition Evaluation Order

When multiple transitions originate from a single source, such as a state or junction, Stateflow uses evaluation order to determine when to test each transition. Depending on which action language your chart uses, you can create the order of your transitions explicitly or implicitly. Whether explicitly or

implicitly ordered, transitions show a number near the source of the transition that designates the transition order.

Note Use explicit ordering to avoid your transitions from changing order while you are editing a chart.

Explicit Ordering

When you open a new Stateflow chart, all outgoing transitions from a source are automatically numbered in the order in which you create them. The order starts with 1 and continues to the next available number for the source.

To change the execution order of a transition, right-click the transition, place your cursor over **Execution Order**, and select the order in which you want your transition to execute. When you change a transition number, the Stateflow chart automatically renumbers the other outgoing transitions for the source by preserving their relative order.

Implicit Ordering

For C charts in implicit ordering mode, a Stateflow chart evaluates a group of outgoing transitions from a single source based on:

- Hierarchy.

A chart evaluates a group of outgoing transitions in an order based on the hierarchical level of the parent of each transition.

- Label.

A chart evaluates a group of outgoing transitions with equal hierarchical priority based on the labels, in the following order of precedence:

- 1 Labels with events and conditions
- 2 Labels with events
- 3 Labels with conditions
- 4 No label

- Angular surface position of transition source.

A chart evaluates a group of outgoing transitions with equal hierarchical and label priority based on angular position on the surface of the source object. The transition with the smallest clock position has the highest priority. For example, a transition with a 2 o'clock source position has a higher priority than a transition with a 4 o'clock source position. A transition with a 12 o'clock source position has the lowest priority.

Outgoing Transition Example

In this example, the Stateflow chart is initialized and the entry actions are performed for `StateA`. A new time step occurs and the chart wakes up. By following the “Workflow for Stateflow Chart Execution” on page 3-23, Stateflow finds multiple outgoing transitions from `StateA`. At this time step $x = 1$, $y = 1$, and $z = 1$.

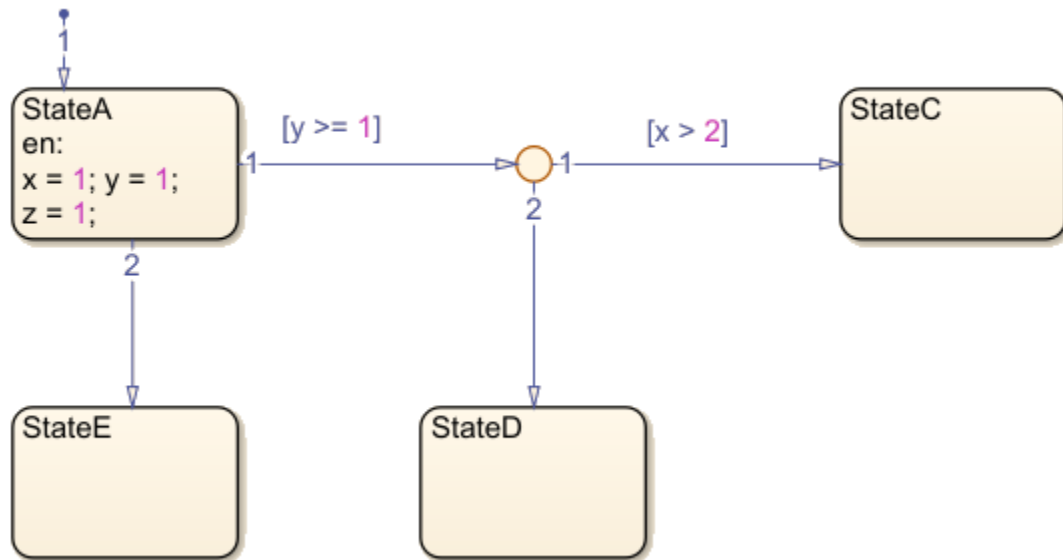

Evaluate Outgoing Transitions

By following the “Workflow for Evaluating Transitions” on page 3-38, the steps for evaluating the transitions of this chart are in this order:

- 1 Transition 1 from StateA is marked for evaluation.
- 2 Transition 1 from StateA has a condition.
- 3 The condition is true.
- 4 The destination of transition 1 from StateA is not a state.
- 5 The junction does have outgoing transitions.
- 6 Transition 1 from the junction is marked for evaluation.
- 7 Transition 1 from the junction has a condition.
- 8 The condition is false.
- 9 Transition 2 from the junction is marked for evaluation.
- 10 Transition 2 from the junction does not have a condition.
- 11 The destination of transition 2 from the junction is a state (StateD).
- 12 StateD is marked for entry, and StateA is marked for exit.

To complete the time step, follow the “Workflow for Exiting a State” on page 3-34 for StateA and the “Workflow for Entering a Chart or State” on page 3-28 for StateE.

Outgoing Transition Example with Backtracking

When all outgoing transitions from a source are invalid or do not end with a terminating junction, but there are previously unevaluated transitions, Stateflow returns to the previous state or junction to evaluate all possible paths.

In this example, the Stateflow chart is initialized and the entry actions are performed for StateA. A new time step occurs, and the chart wakes up. By following the “Workflow for Stateflow Chart

Execution” on page 3-23, Stateflow finds multiple outgoing transitions from StateA. At this time step $x = 1$, $y = 1$, and $z = 1$.

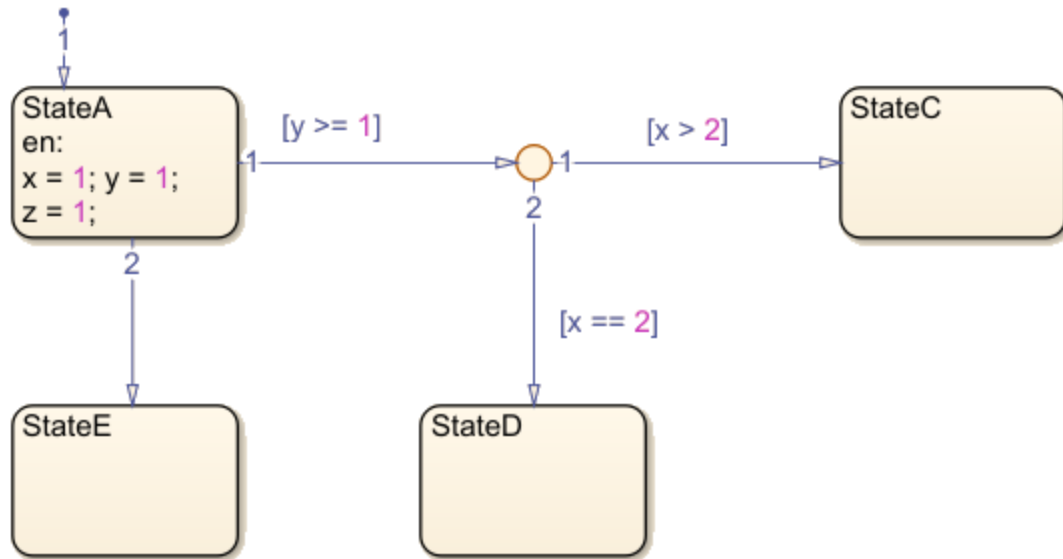

Evaluate Outgoing Transitions with Backtracking

By following the “Workflow for Evaluating Transitions” on page 3-38, the steps for evaluating the transitions of this chart are in this order:

- 1 Transition 1 from StateA is marked for evaluation.
- 2 Transition 1 from StateA has a condition.
- 3 The condition is true.
- 4 The destination of transition 1 from StateA is not a state.
- 5 The junction does have outgoing transitions.
- 6 Transition 1 from the junction is marked for evaluation.
- 7 Transition 1 from the junction has a condition.
- 8 The condition is false.
- 9 Transition 2 from the junction is marked for evaluation.
- 10 Transition 2 from the junction has a condition.
- 11 The condition is false.
- 12 Transition 2 from StateA is marked for evaluation.
- 13 Transition 2 from StateA does not have a condition.
- 14 The destination of transition 2 from StateA is a state (StateE).
- 15 StateE is marked for entry, and StateA is marked for exit.

To complete the time step, follow the “Workflow for Exiting a State” on page 3-34 for StateA and the “Workflow for Entering a Chart or State” on page 3-28 for StateE.

Prevent Backtracking

In this example, a terminating junction prevents backtracking. The Stateflow chart is initialized and the entry actions are performed for StateA. A new time step occurs and the chart wakes up. By following the “Workflow for Stateflow Chart Execution” on page 3-23, Stateflow finds multiple outgoing transitions from StateA. At this time step $x = 1$, $y = 1$, and $z = 1$.

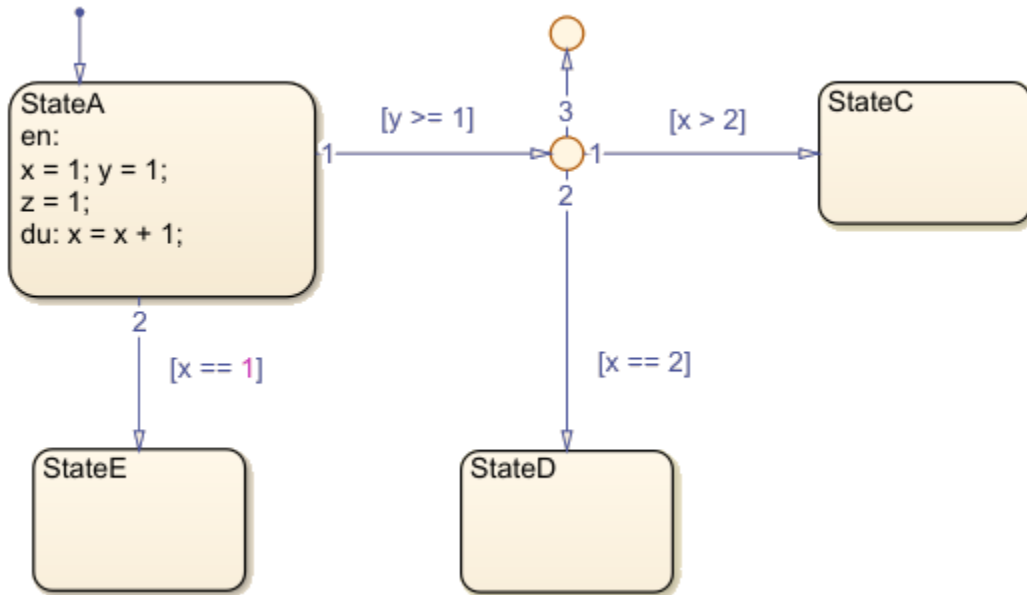

By following the “Workflow for Evaluating Transitions” on page 3-38, the steps for evaluating the transitions of this chart are in this order:

- 1 Transition 1 from StateA is marked for evaluation.
- 2 Transition 1 from StateA has a condition.
- 3 The condition is true.
- 4 The destination of transition 1 from StateA is not a state.
- 5 The junction does have outgoing transitions.
- 6 Transition 1 from the junction is marked for evaluation.
- 7 Transition 1 from the junction has a condition.
- 8 The condition is false.
- 9 Transition 2 from the junction is marked for evaluation.
- 10 Transition 2 from the junction has a condition.
- 11 The condition is false.
- 12 Transition 3 from the junction is marked for evaluation.
- 13 Transition 3 from the junction does not have a condition.
- 14 The destination is not a state and does not have any outgoing transitions.
- 15 Return to “Workflow for Stateflow Chart Execution” on page 3-23.

To complete the time step, follow the “Workflow for Stateflow Chart Execution” on page 3-23 for StateA, starting where you left off.

Condition and Transition Actions

Condition Actions

In transition label syntax, condition actions follow the transition condition and are enclosed in curly braces (`{}`). Condition actions are executed when the condition is evaluated as true but before the transition path has been determined to be valid.

Transition Actions

In transition label syntax, transition actions are preceded with a forward slash (`/`) and are enclosed in curly braces (`{}`). Transition actions execute only after the transition path is determined to be valid.

In this example, both condition actions and transition actions exist. The Stateflow chart is initialized and the entry actions are performed for StateA. A new time step occurs and the chart wakes up. There are multiple outgoing transitions from StateA. At this time step $x = 1$, $y = 1$, and $z = 1$.

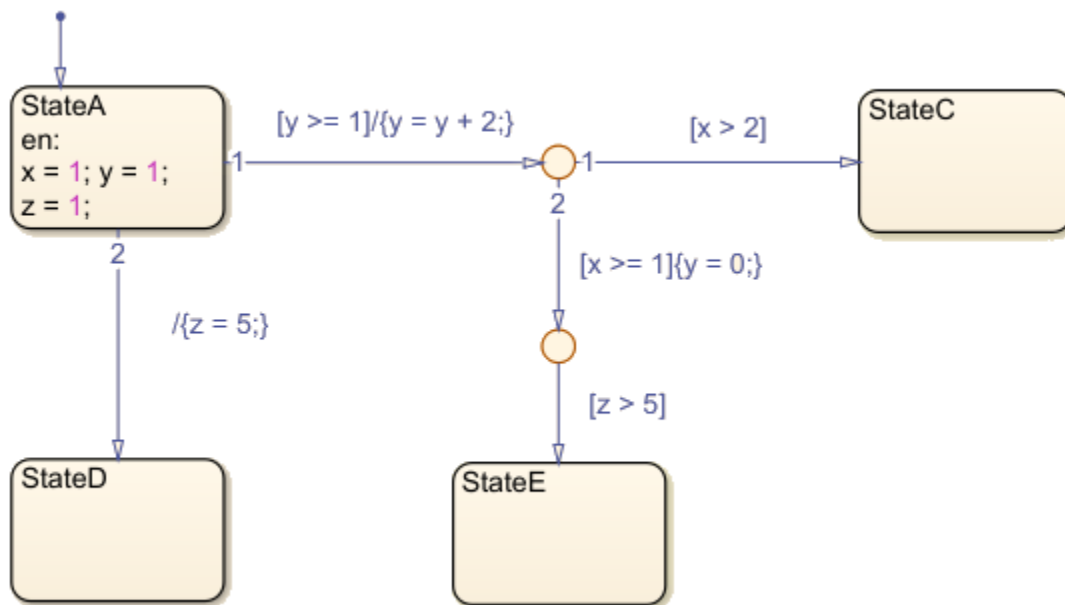

Evaluate Outgoing Transitions with Condition and Transition Actions

By following the “Workflow for Evaluating Transitions” on page 3-38, the steps for evaluating the transitions of this chart are in this order:

- 1 Transition 1 from StateA is marked for evaluation.
- 2 Transition 1 from StateA has a condition (`[y >= 1]`).
- 3 The condition is true.
- 4 There are no condition actions.
- 5 The destination of transition 1 from StateA is not a state.
- 6 The junction does have outgoing transitions.
- 7 Transition 1 from the junction is marked for evaluation.
- 8 Transition 1 from the junction has a condition (`[x > 2]`).

- 9 The condition is false.
- 10 Transition 2 from the junction is marked for evaluation.
- 11 Transition 2 from the junction has a condition ($[x \geq 1]$).
- 12 The condition is true.
- 13 There is a condition action ($\{y = 0;\}$). Now $y = 0$.
- 14 The junction does have outgoing transitions.
- 15 The transition from the junction is marked for evaluation.
- 16 Transition 1 from the junction has a condition ($[z \geq 5]$).
- 17 The condition is false.
- 18 Transition 2 from StateA is marked for evaluation.
- 19 Transition 2 from StateA does not have a condition.
- 20 The destination of transition 2 from StateA is a state (StateD).
- 21 StateD is marked for entry, and StateA is marked for exit. Execute the transition action for this valid path ($/\{z = 5\}$). Now $z = 5$.

To complete the time step, follow the “Workflow for Exiting a State” on page 3-34 for StateA and the “Workflow for Entering a Chart or State” on page 3-28 for StateE.

See Also

More About

- “Execution of a Stateflow Chart” on page 3-23
- “Enter a Chart or State” on page 3-28
- “Exit a State” on page 3-34

Super Step Semantics

By default, Stateflow charts execute once for each input event or time step. If you are modeling a system that must react quickly to inputs, you can enable super step semantics. Super step semantics are supported only in Stateflow charts in a Simulink model.

When you enable super step semantics, a Stateflow chart executes multiple times for every active input event or for every time step when the chart has no input events. The chart takes valid transitions until *either* of these conditions occurs:

- No more valid transitions exist, that is, the chart is in a stable active state configuration.
- The number of transitions taken exceeds a user-specified maximum number of iterations.

In a super step, your chart responds faster to inputs but performs more computations in each time step. Therefore, when generating code for an embedded target, make sure that the chart can finish the computation in a single time step. To achieve this behavior, fine-tune super step parameters by setting an upper limit on the number of transitions that the chart takes per time step (see “Maximum Number of Iterations” on page 3-45).

For simulation targets, specify whether the chart goes to the next time step or generates an error if it reaches the maximum number of transitions prematurely. However, in generated code for embedded targets, the chart always goes to the next time step after taking the maximum number of transitions.

Maximum Number of Iterations

In a super step, your chart always takes at least one transition. Therefore, when you set a maximum number of iterations in each super step, the chart takes that number of transitions plus 1. For example, if you specify 10 as the maximum number of iterations, your chart takes 11 transitions in each super step. To set maximum number of iterations in each super step, see “Enable Super Step Semantics” on page 3-45.

Enable Super Step Semantics

To enable super step semantics:

- 1 Right-click inside the top level of a chart and select **Properties** from the context menu.
- 2 In the Chart properties dialog box, select the **Enable Super Step Semantics** check box.

Two additional fields appear below that check box.

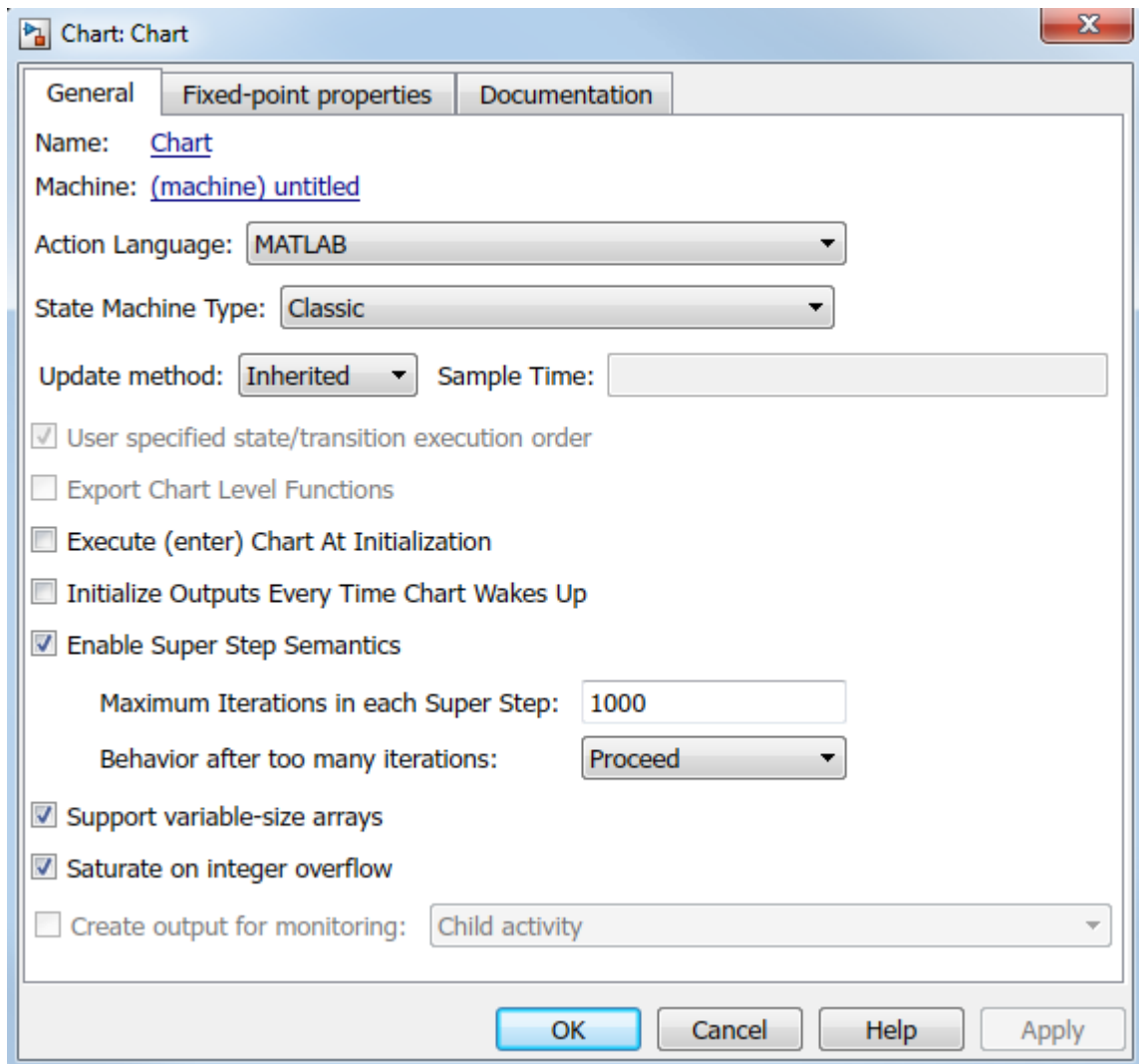

- 3 Enter a value in the field **Maximum Iterations in each Super Step**.

The chart always takes one transition during a super step, so the value N that you specify represents the maximum number of *additional* transitions (for a total of $N+1$). Try to choose a number that allows the chart to reach a stable state within the time step, based on the mode logic of your chart. For more information, see “Maximum Number of Iterations” on page 3-45

- 4 Select an action from the drop-down menu in the field **Behavior after too many iterations**.

Your selection determines how the chart behaves during simulation if it exceeds the maximum number of iterations in the super step before reaching a stable state.

Behavior	Description
Proceed	The chart goes back to sleep with the last active state configuration, that is, after updating local data at the last valid transition in the super step.

Behavior	Description
Throw Error	Simulation stops and the chart generates an error, indicating that too many iterations occurred while trying to reach a stable state. Note Selecting Throw Error can help detect infinite loops in transition cycles (see “Detection of Infinite Loops in Transition Cycles” on page 3-50).

Note This option is relevant only for simulation targets. For embedded targets, code generation goes to the next time step rather than generating an error.

Super Step Example

The following model shows how super step semantics differs from default semantics:

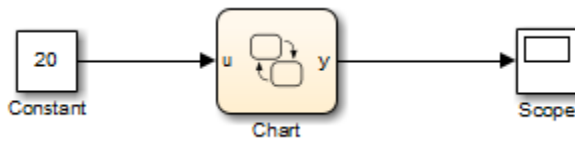

In this model, a Constant block outputs a constant value of 20 to input u in a Stateflow chart. Because the value of u is always 20, each transition in the chart is valid:

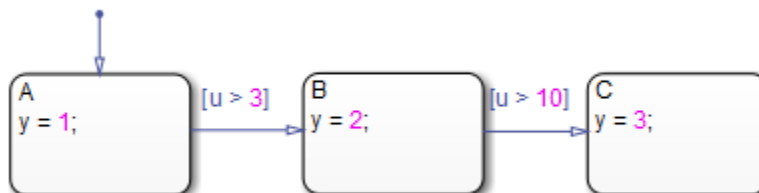

By default, the chart takes only one transition in each simulation step, incrementing y each time.

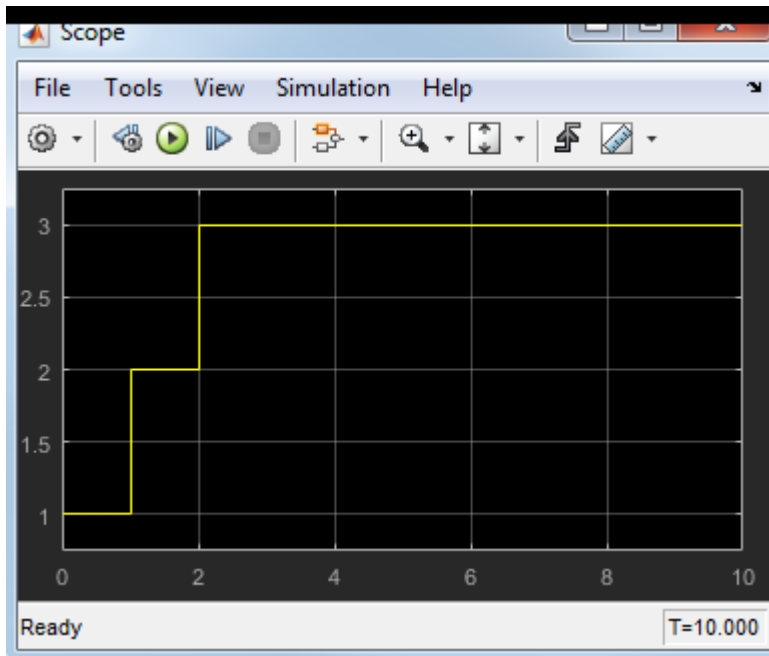

When you enable super step semantics, the chart takes all valid transitions in each time step, stopping at state C with $y = 3$.

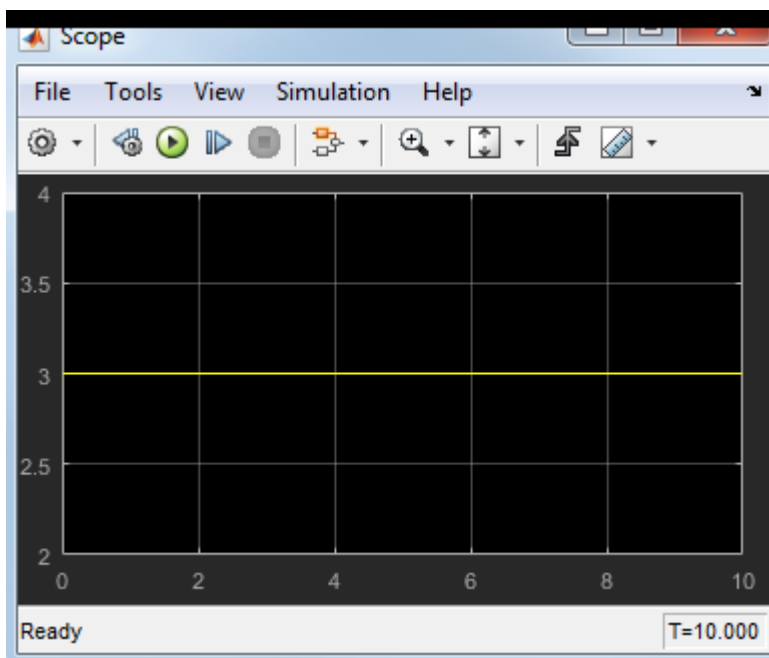

How Super Step Semantics Works with Multiple Input Events

When you enable super step semantics for a chart with multiple active input events, the chart takes all valid transitions for the first active event before it begins processing the next active event. For example, consider the following model:

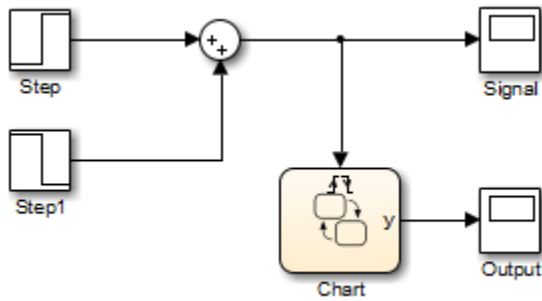

In this model, the Sum block produces a 2-by-1 vector signal that goes from [0,0] to [1,1] at time $t = 1$. As a result, when the model wakes up the chart, events E1 and E2 are both active:

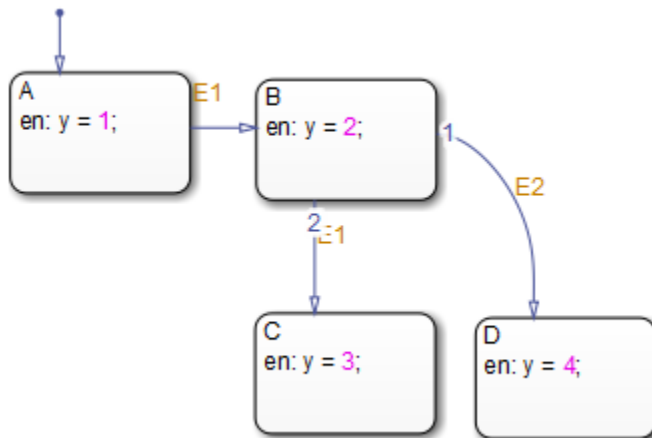

If you enable super step semantics, the chart takes all valid transitions for event E1. The chart takes transitions from state A to B and then from state B to C in a single super step. The scope shows that $y = 3$ at the end of the super step:

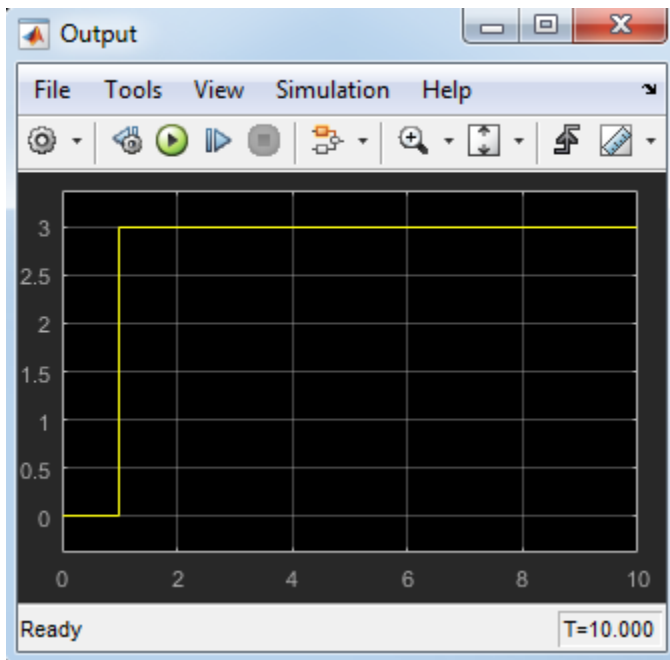

In a super step, this chart never transitions to state D because there is no path from state C to state D.

Detection of Infinite Loops in Transition Cycles

If your chart contains transition cycles, taking multiple transitions in a single time step can cause infinite loops. Consider the following example:

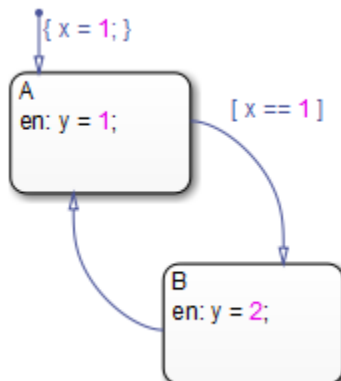

In this example, the transitions between states A and B cycle and produce an infinite loop because the value of x remains constant at 1. One way to detect infinite loops is to configure your chart to generate an error if it reaches a maximum number of iterations in a super step. See "Enable Super Step Semantics" on page 3-45.

Use Events to Execute Charts

An event is a nongraphical object that can wake up and trigger actions in Stateflow chart. For more information, see “Synchronize Model Components by Broadcasting Events” on page 11-2.

How Stateflow Charts Respond to Events

Stateflow charts respond to events in a cyclical manner.

- 1 An event wakes up an inactive chart.
- 2 The chart responds to the event by executing transitions and state actions from the top down through the chart hierarchy. Starting at the chart level:
 - a The chart checks for valid transitions between states.
 - b The chart executes **during** and **on** actions for the active state.
 - c The chart proceeds to the next level down the hierarchy.
- 3 The chart becomes inactive until it receives the next event.

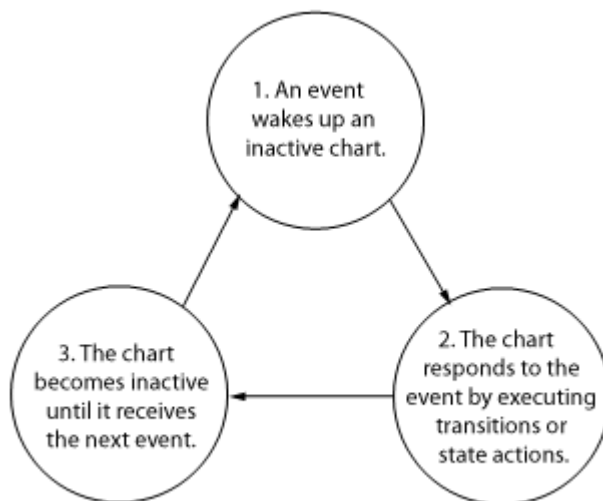

For more information, see “Execution of a Stateflow Chart” on page 3-23.

Events in Simulink Models

In Simulink models, Stateflow charts receive input events from other blocks in the model.

While processing an event, a state or transition action can generate explicit or implicit events that trigger additional steps. For example:

- The operator `send` can broadcast local or output events.
- The operators `enter` and `exit` can generate implicit local events when the chart execution enters or exits a state.
- The operator `change` can generate an implicit local event when the chart sets the value of a variable.

In each case, the chart interrupts its current activity to process the new event. When the activity caused by the new event finishes executing, the chart returns to the activity that was taking place before the interruption.

Note In a Simulink model, the execution of output edge-trigger events is equivalent to toggling the value of an output data value between 0 and 1. This type of event does not interrupt the current activity of a chart. Instead, the receiving block processes the event the next time that the model executes the block. For more information, see “Activate a Simulink Block by Sending Output Events” on page 11-14.

Early Return Logic

The results of processing a local event can conflict with the action that was taking place before the event was generated. Depending on the type of action, charts resolve these conflicts by using early return logic.

Action Type	Early Return Logic
State entry action	If the state is no longer active after the local event is processed, the chart stops the process of entering the state. The chart does not perform the remaining statements in the entry action.
State during action	If the state is no longer active after the local event is processed, the chart stops executing the state. The chart does not perform the remaining statements in the during action.
State exit action	If the state is no longer active after the local event is processed, the chart stops the process of exiting the state. The chart does not perform the remaining statements in the exit action nor any transition actions and state entry actions that result from exiting the state.
Condition action	If the source state of the inner or outer transition path, or the parent state of the default transition path, is no longer active after the local event is processed, the chart stops the transition process. The chart does not perform the remaining actions on the transition path or any state exit and entry actions that result from taking the transition.
Transition action	If the parent of the transition path is not active, or if the parent has an active substate, the chart stops the transition process. The chart does not perform the remaining actions on the transition path or any state entry actions that result from taking the transition.

For example, in this chart, the input event E and the local event F trigger the transitions between states.

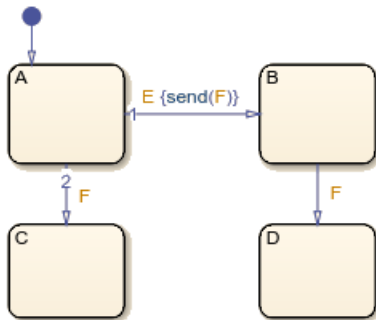

Suppose that state A is active when the chart receives event E. The chart responds to the event with these steps:

- 1 The chart determines that the transition from the active state A to state B is valid as a result of event E.
- 2 The chart executes the condition action of the valid transition and broadcasts event F.
- 3 The chart interrupts the transition from state A to state B and begins to process event F.
- 4 The chart determines that the transition from the active state A to state C is valid as a result of event F.
- 5 State A executes its `exit` action.
- 6 State A becomes inactive.
- 7 State C becomes active.
- 8 State C executes its `entry` action.

After the chart processes event F, state C is the active state of the chart. Because state A is no longer active, the chart uses early return logic and stops the transition from state A to state B.

Tip Avoid using undirected local event broadcasts. Undirected local event broadcasts can cause unwanted recursive behavior in your chart. Instead, send local events by using directed broadcasts. For more information, see “Broadcast Local Events to Synchronize Parallel States” on page 13-37.

You can set the diagnostic level for detecting undirected local event broadcasts. In the Configuration Parameters dialog box, open the **Diagnostics > Stateflow** pane and set the **Undirected event broadcasts** parameter to `none`, `warning`, or `error`. The default setting is `warning`.

Events in Standalone Charts

Standalone Stateflow charts receive an input event when you call the `step` function or an input event function in MATLAB.

Standalone charts also receive implicit events from MATLAB timer objects associated with the absolute-time temporal logic operators `after`, `at`, and `every`. These operators define temporal logic in terms of wall-clock time. If the state associated with the temporal logic operator becomes inactive before the chart processes the implicit event, the event does not wake up the chart.

Queuing of Events

If a chart is processing another operation when it receives an event, the chart queues the event for execution when the current step is completed. You can specify the size of the event queue by setting

the configuration option `-eventQueueSize` when you create the chart object. For more information, see “Chart Object Configuration Options” on page 35-4.

For example, in this chart, the input events E and F trigger the transitions between states. Assume that `SendF` is a function in the MATLAB path that calls the input event function F.

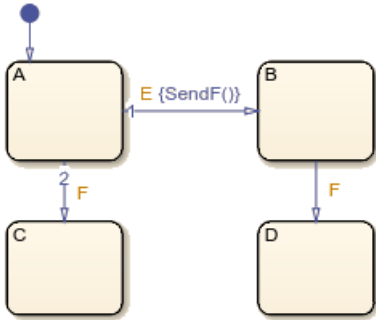

Suppose that state A is active when the chart receives event E. The chart responds to the event with these steps:

- 1 The chart determines that the transition from the active state A to state B is valid as a result of event E.
- 2 The chart executes the condition action of the valid transition and calls the function `SendF`.
- 3 `SendF` calls the input event function F. Because the chart is busy processing a condition action, it queues event F.
- 4 The chart completes executing the condition action.
- 5 State A executes its `exit` action.
- 6 State A becomes inactive.
- 7 State B becomes active.
- 8 State B executes its `entry` action.
- 9 The chart begins to process the queued event F.
- 10 The chart determines that the transition from the active state B to state D is valid as a result of event F.
- 11 State B executes its `exit` action.
- 12 State B becomes inactive.
- 13 State D becomes active.
- 14 State D executes its `entry` action.

After the chart processes event F, state D is the active state of the chart.

See Also

after | at | change | enter | every | exit | send | timer

More About

- “Execution of a Stateflow Chart” on page 3-23

- “Synchronize Model Components by Broadcasting Events” on page 11-2
- “Control Chart Behavior by Using Implicit Events” on page 11-23
- “Control Chart Execution by Using Temporal Logic” on page 13-40

Group and Execute Transitions

Transition Flow Chart Types

Before executing transitions for an active state or chart, Stateflow software groups transitions by the following types:

- Default flow charts are all default transition segments that start with the same parent.
- Inner flow charts are all transition segments that originate on a state and reside entirely within that state.
- Outer flow charts are all transition segments that originate on the respective state but reside at least partially outside that state.

Each set of flow charts includes other transition segments connected to a qualifying transition segment through junctions and transitions. Consider the following example:

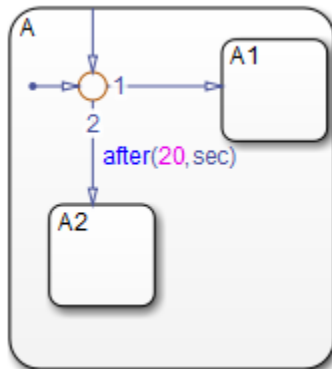

In this example, state A has both an inner and a default transition that connect to a junction with outgoing transitions to states A.A1 and A.A2. If state A is active, its set of inner flow charts includes:

- The inner transition
- The outgoing transitions from the junction to state A.A1 and A.A2

In addition, the set of default flow charts for state A includes:

- The default transition to the junction
- The two outgoing transitions from the junction to state A.A1 and A.A2

In this case, the two outgoing transition segments from the junction are members of more than one flow chart type.

Order of Execution for a Set of Flow Charts

Each flow chart group executes in the order of group priority until a valid transition appears. The default transition group executes first, followed by the outer transitions group and then the inner transitions group. Each flow chart group executes as follows:

- 1 Order the group's transition segments for the active state.

An active state can have several possible outgoing transitions. The chart orders these transitions before checking them for validity. See "Transition Evaluation Order" on page 3-38.

- 2** Select the next transition segment in the set of ordered transitions.
- 3** Test the transition segment for validity.
- 4** If the segment is invalid, go to step 2.
- 5** If the destination of the transition segment is a state, do the following:
 - a** Testing of transition segments stops and a transition path forms by backing up and including the transition segment from each preceding junction back to the starting transition.
 - b** The states that are the immediate substates of the parent of the transition path exit (see "Exit a State" on page 3-34).
 - c** The transition action from the final transition segment of the full transition path executes.
 - d** The destination state becomes active (see "Enter a Chart or State" on page 3-28).
- 6** If the destination is a junction with no outgoing transition segments, do the following:
 - a** Testing stops without any state exits or entries.
- 7** If the destination is a junction with outgoing transition segments, repeat step 1 for the set of outgoing segments.
- 8** After testing all outgoing transition segments at a junction, take the following actions:
 - a** Backtrack the incoming transition segment that brought you to the junction.
 - b** Continue at step 2, starting with the next transition segment after the backup segment.

The set of flow charts completes execution when all starting transitions have been tested.

Execution Order for Parallel States

Ordering for Parallel States

Although multiple parallel (AND) states in the same chart execute concurrently, the Stateflow chart must determine when to activate each one during simulation. This ordering determines when each parallel state performs the actions that take it through all stages of execution.

Unlike exclusive (OR) states, parallel states do not typically use transitions. Instead, order of execution depends on:

- Explicit ordering

Specify explicitly the execution order of parallel states on a state-by-state basis (see “Explicit Ordering of Parallel States” on page 3-58).

- Implicit ordering

Override explicit ordering by letting a Stateflow chart use internal rules to order parallel states (see “Implicit Ordering of Parallel States” on page 3-59).

Parallel states are assigned priority numbers based on order of execution. The lower the number, the higher the priority. The priority number of each state appears in the upper right corner.

Because execution order is a chart property, all parallel states in the chart inherit the property setting. You cannot mix explicit and implicit ordering in the same Stateflow chart. However, you can mix charts with different ordering modes in the same Simulink model.

In code that is generated from Stateflow charts that contain parallel states, each state executes based on its order.

Explicit Ordering of Parallel States

By default, a Stateflow chart orders parallel states explicitly based on execution priorities you set.

How Explicit Ordering Works

When you open a new Stateflow chart — or one that does not yet contain any parallel states — the chart automatically assigns priority numbers to parallel states in the order you create them. Numbering starts with the next available number within the parent container.

When you enable explicit ordering in a chart that contains implicitly ordered parallel states, the implicit priorities are preserved for the existing parallel states. When you add new parallel states, execution order is assigned in the same way as for new Stateflow charts — in order of creation.

You can reset execution order assignments at any time on a state-by-state basis, as described in “Set Execution Order for Parallel States Individually” on page 3-59. When you change execution order for a parallel state, the Stateflow chart automatically renumbers the other parallel states to preserve their relative execution order. For details, see “Order Maintenance for Parallel States” on page 3-60.

Order Parallel States Explicitly

To use explicit ordering for parallel states, perform these tasks:

- 1 “Enable Explicit Ordering at the Chart Level” on page 3-59
- 2 “Set Execution Order for Parallel States Individually” on page 3-59

Enable Explicit Ordering at the Chart Level

To enable explicit ordering for parallel states, follow these steps:

- 1 Right-click inside the top level of the chart and select **Properties** from the context menu.

The Chart properties dialog box appears.

- 2 Select the **User-specified state/transition execution order** check box.
- 3 Click **OK**.

If your chart already contains parallel states that have been ordered implicitly, the existing priorities are preserved until you explicitly change them. When you add new parallel states in explicit mode, your chart automatically assigns priorities based on order of creation (see “How Explicit Ordering Works” on page 3-58). However you can now explicitly change execution order on a state-by-state basis, as described in “Set Execution Order for Parallel States Individually” on page 3-59.

Set Execution Order for Parallel States Individually

In explicit ordering mode, you can change the execution order of individual parallel states. Right-click the parallel state of interest and select a new priority from the **Execution Order** menu.

Implicit Ordering of Parallel States

Rules of Implicit Ordering for Parallel States

In implicit ordering mode, a Stateflow chart orders parallel states implicitly based on location. Priority goes from top to bottom and then left to right, based on these rules:

- The higher the vertical position of a parallel state in the chart, the higher the execution priority for that state.
- Among parallel states with the same vertical position, the leftmost state receives highest priority.

The following example shows how these rules apply to top-level parallel states and parallel substates.



Note Implicit ordering creates a dependency between design layout and execution priority. When you rearrange parallel states in your chart, you can accidentally change order of execution and affect simulation results. For more control over your designs, use the default explicit ordering mode to set execution priorities.

Order Parallel States Implicitly

To use implicit ordering for parallel states, follow these steps:

- 1 Right-click inside the top level of the chart and select **Properties** from the context menu.
- 2 In the Chart properties dialog box, clear the **User-specified state/transition execution order** check box.
- 3 Click **OK**.

Order Maintenance for Parallel States

Whether you use explicit or implicit ordering, a chart tries to reconcile execution priorities when you remove, renumber, or add parallel states. In these cases, a chart reprioritizes the parallel states to:

- Fill in gaps in the sequence so that ordering is contiguous
- Ensure that no two states have the same priority
- Preserve the intended relative priority of execution

How a Chart Preserves Relative Priorities in Explicit Mode

For explicit ordering, a chart preserves the user-specified priorities. Consider this example of explicit ordering:

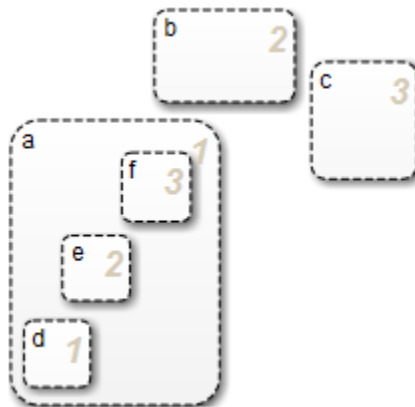

Because of explicit ordering, the priority of each state and substate matches the order of creation in the chart. The chart reprioritizes the parallel states and substates when you perform these actions:

- 1 Change the priority of top-level state **b** to 3.
- 2 Add a top-level state **g**.
- 3 Remove substate **e**.

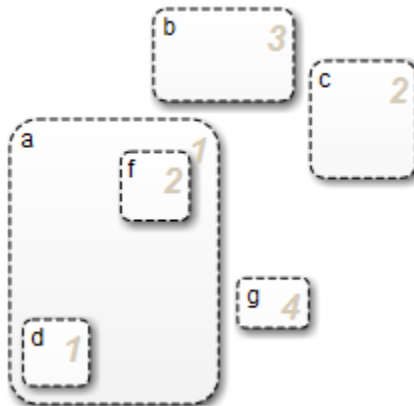

The chart preserves the priority set explicitly for top-level state *b*, but renumbers all other parallel states to preserve their prior relative order.

How a Chart Preserves Relative Priorities in Implicit Mode

For implicit ordering, a chart preserves the intended relative priority based on geometry. Consider this example of implicit ordering:



If you remove top-level state *b* and substate *e*, the chart automatically reprioritizes the remaining parallel states and substates to preserve implicit geometric order:



Execution Priorities in Restored States

There are situations in which you need to restore a parallel state after you remove it from a Stateflow chart. In implicit ordering mode, a chart reassigns the execution priority based on where you restore the state. If you return the state to its original location in the chart, you restore its original priority.

However, in explicit ordering mode, a chart cannot always reinstate the original execution priority to a restored state. It depends on *how* you restore the state.

If you remove a state by...	And restore the state by...	What is the priority?
Deleting, cutting, dragging outside the boundaries of the parent state, or dragging so its boundaries overlap the parent state	Using the undo command	The original priority is restored.
Dragging outside the boundaries of the parent state or so its boundaries overlap the parent state <i>and</i> releasing the mouse button	Dragging it back into the parent state	The original priority is lost. The Stateflow chart treats the restored state as the last created and assigns it the lowest execution priority.
Dragging outside the boundaries of the parent state or so its boundaries overlap the parent state <i>without</i> releasing the mouse button	Dragging it back into the parent state	The original priority is restored.
Dragging so its boundaries overlap one or more sibling states	Dragging it to a location with no overlapping boundaries inside the same parent state	The original priority is restored.
Cutting	Pasting	The original priority is lost. The Stateflow chart treats the restored state as the last created and assigns it the lowest execution priority.

Switching Between Explicit and Implicit Ordering

If you switch to implicit mode after explicitly ordering parallel states, the Stateflow chart resets execution order to follow implicit rules of geometry. However, if you switch from implicit to explicit mode, the chart does not restore the original explicit execution order.

Execution Order of Parallel States in Boxes and Subcharts

When you group parallel states inside a box, the states retain their relative execution order. In addition, the Stateflow chart assigns the box its own priority based on the explicit or implicit ordering rules that apply. This priority determines when the chart activates the parallel states inside the box.

When you convert a state with parallel decomposition into a subchart, its substates retain their relative execution order based on the prevailing explicit or implicit rules.

Create Stateflow Charts

- “Model Reactive Systems in Stateflow” on page 4-2
- “Represent Operating Modes by Using States” on page 4-5
- “Transition Between Operating Modes” on page 4-14
- “Stateflow Editor Operations” on page 4-20

Model Reactive Systems in Stateflow

Identify System Attributes

Before you build a Stateflow chart in a Simulink model, identify your system attributes by answering these questions:

- 1** What are your interfaces?
 - a** What are the event triggers to which your system reacts?
 - b** What are the inputs to your system?
 - c** What are the outputs from your system?
- 2** Does your system have any operating modes?
 - a** If the answer is yes, what are the operating modes?
 - b** Between which modes can you transition? Are there any operating modes that run in parallel?

If your system has no operating modes, the system is stateless. If your system has operating modes, the system is modal.

Select a State Machine Type

After identifying your system attributes, the first step is to create a new chart. For more information, see `sfnw`. Select one of the following state machine types:

- Classic — The default machine type. Provides the full set of semantics for MATLAB charts and C charts.
- Mealy — Machine type in which output is a function of inputs *and* state.
- Moore — Machine type in which output is a function of state.

For more information, see “How Stateflow Objects Interact During Execution” on page 3-5, “Differences Between MATLAB and C as Action Language Syntax” on page 14-5, and “Overview of Mealy and Moore Machines” on page 7-2.

Specify State Actions and Transition Conditions

After you create an empty chart, answer the following questions:

- 1** For each state, what are the actions you want to perform?
- 2** What are the rules for transitioning between your states? If your chart has no states, what are the rules for transitioning between branches of your flow logic?

Using your answers to those questions, specify state actions and transition conditions:

- 1** Draw states to represent your operating modes, if any. See “Represent Operating Modes by Using States” on page 4-5.
- 2** Implement the state actions by adding state labels that use the appropriate syntax. See “State Action Types” on page 13-2.

- 3 Draw transitions to represent the direction of flow logic, between states or between branches of your flow chart. See “Transition Between Operating Modes” on page 4-14.
- 4 Implement the transition conditions by adding transition labels that use the appropriate syntax. See “Transition Action Types” on page 13-7.

Define Persistent Data to Store State Variables

After adding state actions and transition conditions to your chart, determine if the chart requires any local or persistent data to store state variables. If so, follow these steps:

- 1 Add local data to the appropriate level of the chart hierarchy. See “Add Stateflow Data” on page 9-2.

You can also use the Symbol Wizard to add data to your chart. See “Resolve Symbols Through the Symbol Wizard” on page 31-24.

- 2 Specify the type, size, complexity, and other data properties. See “Set Data Properties” on page 9-5.

Simplify State Actions and Transition Conditions with Function Calls

State actions and transition conditions can be complex enough that defining them inline on the state or transition is not feasible. In this case, express the actions or conditions using one of the following types of Stateflow functions:

- Flow chart — Encapsulate flow charts containing if-then-else, switch-case, for, while, or do-while patterns.
- MATLAB — Write matrix-oriented algorithms; call MATLAB functions for data analysis and visualization.
- Simulink — Call Simulink function-call subsystems directly to streamline design and improve readability.
- Truth table — Represent combinational logic for decision-making applications such as fault detection and mode switching.

Use the function format that is most natural for the type of calculation in the state action or transition condition. For more information on the four types of functions, see:

- “Reuse Logic Patterns by Defining Graphical Functions” on page 8-13
- “Reuse MATLAB Code by Defining MATLAB Functions” on page 29-2
- “Reuse Simulink Components in Stateflow Charts” on page 30-2
- “Use Truth Tables to Model Combinatorial Logic” on page 28-2

If the four types of Stateflow functions do not work, you can write your own C or C++ code for integration with your chart. For more information about custom code integration, see “Reuse Custom Code in Stateflow Charts” on page 31-19.

Check That Your System Representation Is Complete

Does your Stateflow chart fully express the logical or event-driven components of your system?

- If the answer is yes, you are done.
- If the answer is no, you can create a separate chart or add hierarchy to your current chart.
 - To create a new chart, repeat all the steps in this basic workflow.
 - To add hierarchy, repeat the previous three steps on lower levels of the current chart.

Represent Operating Modes by Using States

A state describes an operating mode of a reactive system. In a Stateflow chart, states are used for sequential design to create state transition diagrams.

States can be active or inactive. The activity or inactivity of a state can change depending on events and conditions. The occurrence of an event drives the execution of the state transition diagram by making states become active or inactive. For more information, see “States” on page 2-8.

Create a State

You create states by drawing them in the editor for a particular chart (block). Follow these steps:

- 1 Select the State tool:



- 2 Move your pointer into the drawing area.

In the drawing area, the pointer becomes state-shaped (rectangular with oval corners).

- 3 Click in a particular location to create a state.

The created state appears with a question mark (?) label in its upper left-hand corner.

- 4 Click the question mark.

A text cursor appears in place of the question mark.

- 5 Enter a name for the state and click outside of the state when finished.

The label for a state specifies its required name and optional actions. See “Label States” on page 4-11 for more detail.

Move and Resize States

To move a state, do the following:

- 1 Click and drag the state.
- 2 Release it in a new position.

To resize a state, do the following:

- 1 Place your pointer over a corner of the state.

When your pointer is over a corner, it appears as a double-ended arrow (PC only; pointer appearance varies with other platforms).

- 2 Click and drag the state's corner to resize the state and release the left mouse button.

Create Substates and Superstates

A substate is a state that can be active only when another state, called its parent, is active. States that have substates are known as superstates. To create a substate, click the State tool and drag a new state into the state you want to be the superstate. A Stateflow chart creates the substate in the

specified parent state. You can nest states in this way to any depth. To change the parentage of a substate, drag it from its current parent in the chart and drop it in its new parent.

Note A parent state must be graphically large enough to accommodate all its substates. You might need to resize a parent state before dragging a new substate into it. You can bypass the need for a state of large graphical size by declaring a superstate to be a subchart. See “Encapsulate Modal Logic by Using Subcharts” on page 8-4 for details.

Group States

When to Group a State

Group a state to move all graphical objects inside a state together. When you group a state, the chart treats the state and its contents as a single graphical unit. This behavior simplifies editing of a chart. For example, moving a grouped state moves all substates and functions inside that state.

How to Group a State

You can group a state by right-clicking it and then selecting **Group & Subchart > Group** in the context menu. The state appears shaded in gray to indicate that it is now grouped.

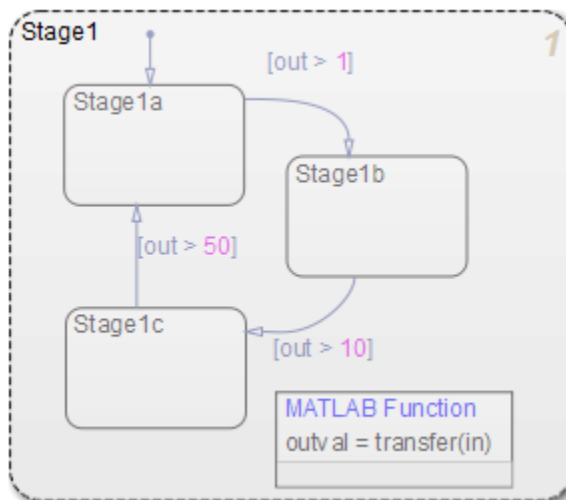

When to Ungroup a State

You must ungroup a state before performing these actions:

- Selecting objects inside the state
- Moving other graphical objects into the state

If you try to move objects such as states and graphical functions into a grouped state, you see an invalid intersection error message. Also, the objects with an invalid intersection have a red border.

How to Ungroup a State

You can ungroup a state by right-clicking it and then clearing **Group & Subchart > Group** in the context menu. The background of the state no longer appears gray.

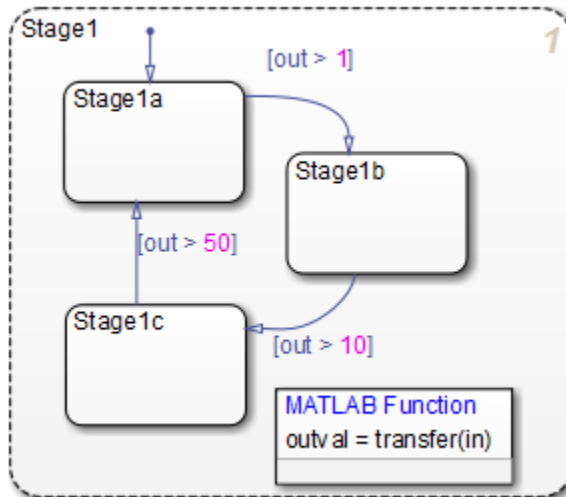

Specify Substate Decomposition

You specify whether a superstate contains parallel (AND) states or exclusive (OR) states by setting its decomposition. A state whose substates are all active when it is active has parallel (AND) decomposition. A state in which only one substate is active when it is active has exclusive (OR) decomposition. An empty state's decomposition is exclusive.

To alter a state's decomposition, select the state, right-click to display the state's **Decomposition** context menu, and select **OR (Exclusive)** or **AND (Parallel)** from the menu.

You can also specify the state decomposition of a chart. In this case, the Stateflow chart treats its top-level states as substates. The chart creates states with exclusive decomposition. To specify a chart's decomposition, deselect any selected objects, right-click to display the chart's **Decomposition** context menu, and select **OR (Exclusive)** or **AND (Parallel)** from the menu.

The appearance of the substates indicates the decomposition of their superstate. Exclusive substates have solid borders, parallel substates, dashed borders. A parallel substate also contains a number in its upper right corner. The number indicates the activation order of the substate relative to its sibling substates.

Specify Activation Order for Parallel States

You can specify activation order by using one of two methods: explicit or implicit ordering.

- By default, when you create a new Stateflow chart, explicit ordering applies. In this case, you specify the activation order on a state-by-state basis.
- You can also override explicit ordering by letting the chart order parallel states based on location. This mode is known as implicit ordering.

For more information, see “Explicit Ordering of Parallel States” on page 3-58 and “Implicit Ordering of Parallel States” on page 3-59.

Note The activation order of a parallel state appears in its upper right corner.

Change State Properties

Use the State dialog box to view and change the properties for a state. To access the State dialog box:

- 1 Right-click the state and select **Properties**.

The State properties dialog box appears. For descriptions of properties, see “Properties You Can Set in the General Pane” on page 4-8 and “Properties You Can Set in the Logging Pane” on page 4-9.

- 2 Modify property settings and then click one of these buttons:
 - **Apply** to save the changes and keep the State dialog box open
 - **Cancel** to return to the previous settings
 - **OK** to save the changes and close the dialog box
 - **Help** to display the documentation in an HTML browser window

Properties You Can Set in the General Pane

The **General** pane of the State properties dialog box appears as shown.

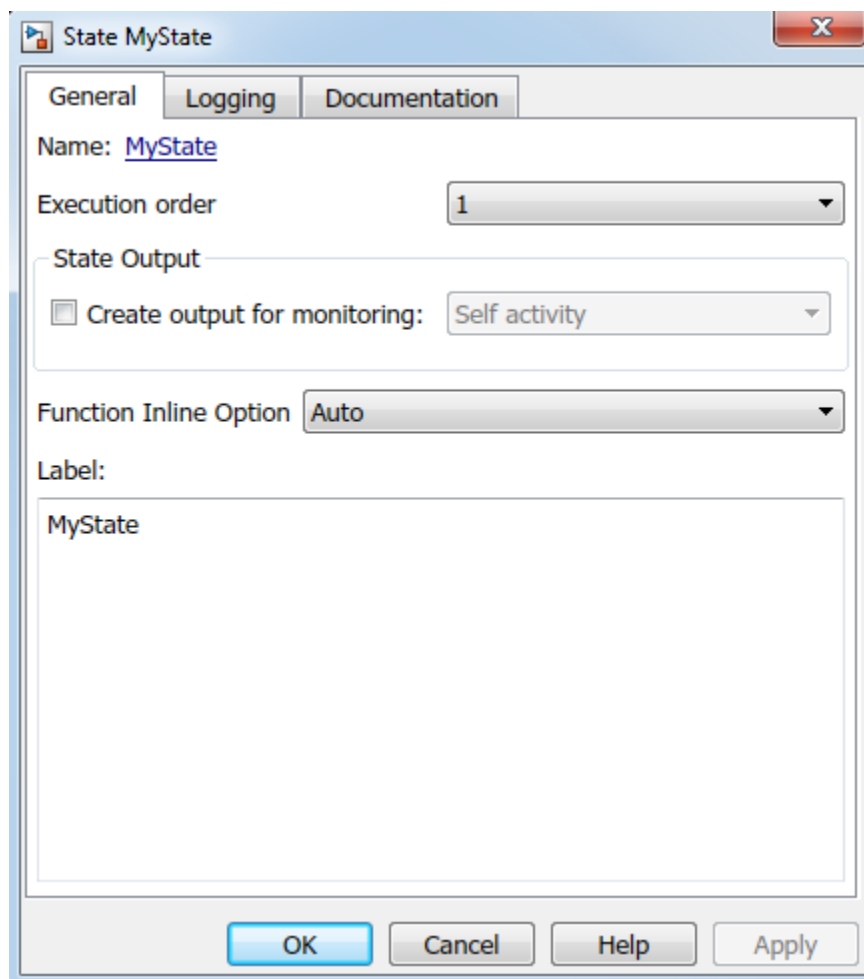

You can set these properties in the **General** pane.

Property	Description
Name	Stateflow chart name; read-only; click this hypertext link to bring the state to the foreground.
Execution order	Set the execution order of a parallel (AND) state. This property does not appear for exclusive (OR) states. See “Execution Order for Parallel States” on page 3-58.
Create data for monitoring	Select this option to create state activity data. See “Monitor State Activity Through Active State Data” on page 10-2.
Function Inline Option	<p>Select one of these options to control the inlining of state functions in generated code:</p> <ul style="list-style-type: none"> • Auto Inlines state functions based on an internal heuristic. • Inline Always inlines state functions in the parent function, as long as the function is not part of a recursion. See “Inline State Functions in Generated Code” (Simulink Coder) • Function Creates separate static functions for each state.
Label	The label for the state, which includes the name of the state and its associated actions. See “Label States” on page 4-11.

Properties You Can Set in the Logging Pane

The **Logging** pane of the State properties dialog box appears as shown.

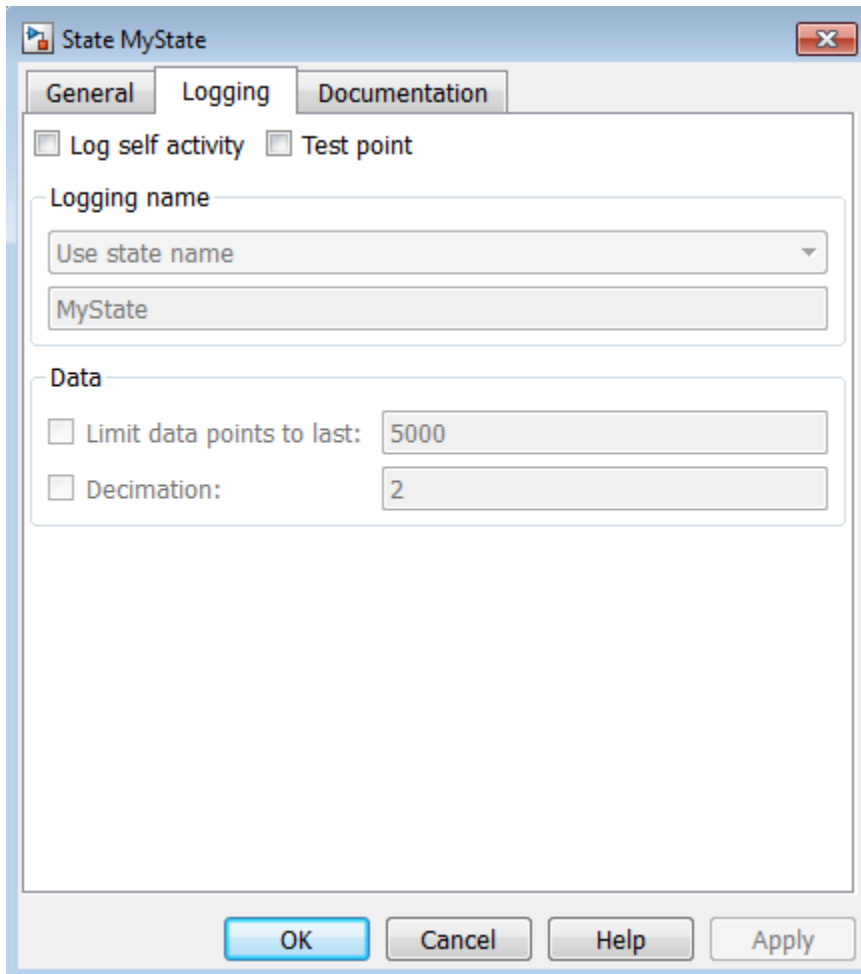

You can set these properties in the **Logging** pane.

Property	Description
Log self activity	Saves the self activity value to the MATLAB workspace during simulation.
Test point	Designates the state as a test point that can be monitored with a floating scope during model simulation. You can also log test point values into MATLAB workspace objects. See “Monitor Test Points in Stateflow Charts” on page 33-41.
Logging name	Specifies the name associated with the logged self activity. Simulink software uses the signal name as its logging name by default. To specify a custom logging name, select Custom from the list box and enter the new name in the adjacent edit field.
Limit data points to last	Limits the self activity logged to the most recent samples.
Decimation	Limits self activity logged by skipping samples. For example, a decimation factor of 2 saves every other sample.

Properties You Can Set in the Documentation Pane

The **Documentation** pane of the State properties dialog box appears as shown.

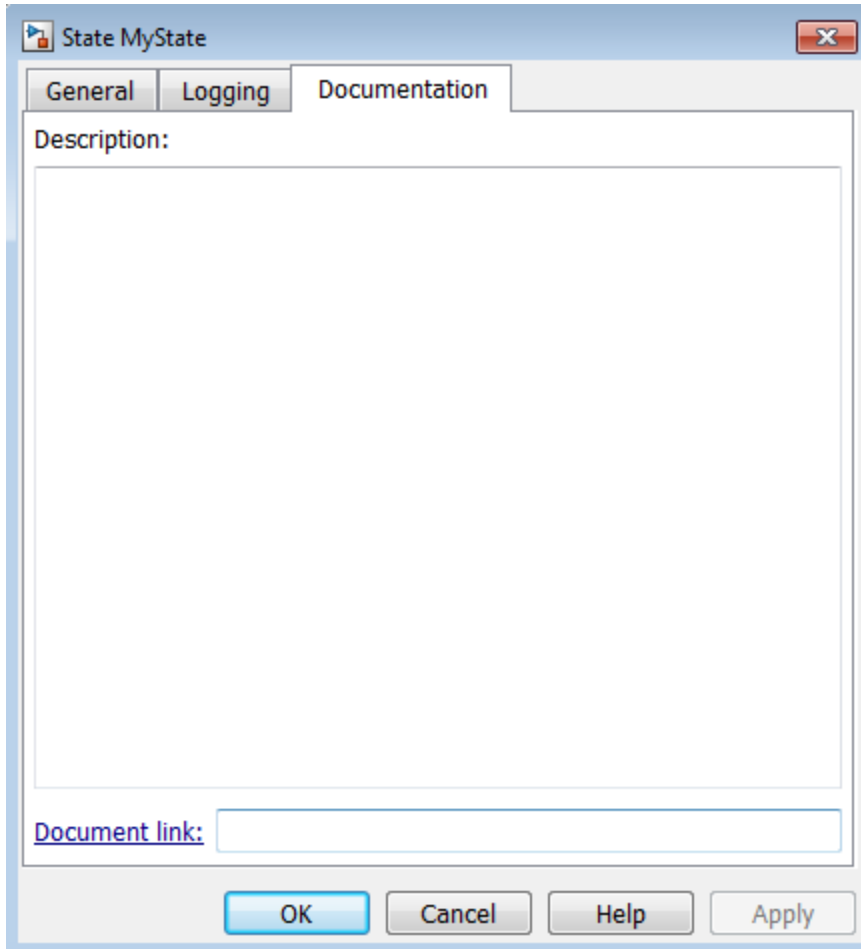

You can set these properties in the **Documentation** pane.

Property	Description
Description	Textual description or comment.
Document link	Enter a URL address or a general MATLAB command. Examples are <code>www.mathworks.com</code> , <code>mailto:email_address</code> , and <code>edit /spec/data/speed.txt</code> .

Label States

The label for a state specifies its required name for the state and the optional actions executed when the state is entered, exited, or receives an event while it is active.

State labels have the following general format.

```
name/
entry:entry actions
```

during:*during actions*
 exit:*exit actions*
 bind:*data and events*
 on *event_or_message_name: on event_or_message_name actions*

The italicized entries in this format have the following meanings:

Keyword	Entry	Description
Not applicable	<i>name</i>	A unique reference to the state with optional slash
entry or en	<i>entry actions</i>	Actions executed when a particular state is entered as the result of a transition taken to that state
during or du	<i>during actions</i>	Actions that are executed when a state receives an event while it is active with no valid transition away from the state
exit or ex	<i>exit actions</i>	Actions executed when a state is exited as the result of a transition taken away from the state
bind	<i>data or events</i>	Binds the specified data or events to this state. Bound data can be changed only by this state or its children, but can be read by other states. Bound events can be broadcast only by this state or its children.
on	<i>event_or_message_name</i> and <i>on event_name actions</i>	A specified event or message and Actions executed when a state is active and the specified event occurs or message is present. For more information, see “Synchronize Model Components by Broadcasting Events” on page 11-2 and “Communicate with Stateflow Charts by Sending Messages” on page 12-2.

Enter the Name

Initially, a state's label is empty. The Stateflow chart indicates this by displaying a ? in the state's label position (upper left corner). Begin labeling the state by entering a name for the state with the following steps:

- 1 Click the state.

The state turns to its highlight color and a question mark character appears in the upper left-hand corner of the state.

- 2 Click the ? to edit the label.

An editing cursor appears. You are now free to type a label.

Enter the state's name in the first line of the state's label. Names are case sensitive. To avoid naming conflicts, do not assign the same name to sibling states. However, you can assign the same name to states that do not share the same parent.

After labeling the state, click outside it. Otherwise, continue entering actions. To reedit the label, click the label text near the character position you want to edit.

Enter Actions

After entering the name of the state in the label, you can enter actions for any of the following action types:

- **Entry Actions** — begin on a new line with the keyword `entry` or `en`, followed by a colon, followed by one or more action statements on one or more lines. To separate multiple actions on the same line, use a comma or a semicolon.

You can begin entry actions on the same line as the state's name. In this case, begin the entry action with a forward slash (/) instead of the entry keyword.

- **Exit Actions** — begin on a new line with the keyword `exit` or `ex`, followed by a colon, followed by one or more action statements on one or more lines. To separate multiple actions on the same line, use a comma or a semicolon.
- **During Actions** — begin on a new line with the keyword `during` or `du`, followed by a colon, followed by one or more action statements on one or more lines. To separate multiple actions on the same line, use a comma or a semicolon.
- **Bind Actions** — begin on a new line with the keyword `bind` followed by a colon, followed by one or more data or events on one or more lines. To separate multiple actions on the same line, use a comma or a semicolon.
- **On Actions** — begin with the keyword `on`, followed by a space and the name of an event or message, followed by a colon, followed by one or more action statements on one or more lines, for example

```
on ev1: exit();
```

To separate multiple actions on the same line, use a comma or a semicolon. If you want different events to trigger different actions, enter multiple `on` blocks in the state label. Each block specifies the action for a specific event or message, for example:

```
on ev1: action1(); on ev2: action2();
```

The execution of the actions you enter for a state is dependent only on their action type, and not the order in which you enter actions in the label. If you do *not* specify the action type explicitly for a statement, the chart treats that statement as an entry action.

Tip You can also edit the label in the properties dialog box for the state. See “Change State Properties” on page 4-8.

See Also

States

More About

- “State Action Types” on page 13-2
- “Eliminate Redundant Code by Combining State Actions” on page 13-10
- “Record State Activity by Using History Junctions” on page 8-2
- “Monitor State Activity Through Active State Data” on page 10-2

Transition Between Operating Modes

A transition is a line with an arrowhead that links one graphical object to another. In most cases, a transition represents the passage of the system from one mode (state) to another. A transition typically connects a source and a destination object. The source object is where the transition begins and the destination object is where the transition ends. For more information, see “Transitions” on page 2-18.

Create a Transition

Follow these steps to create transitions between states and junctions:

- 1 Place your pointer on or close to the border of a source state or junction.

The pointer changes to crosshairs.

- 2 Click and drag a transition to a destination state or junction.
- 3 Release on the border of the destination state or junction.

Attached transitions obey the following rules:

- Transitions do not attach to the corners of states. Corners are used exclusively for resizing.
- Transitions exit a source and enter a destination at angles perpendicular to the source or destination surface.
- All transitions have smart behavior.

To delete a transition, click it and press the **Delete** key.

See the following sections for help with creating self-loop and default transitions:

- “Create Self-Loop Transitions” on page 4-17
- “Create Default Transitions” on page 4-17

Label Transitions

Transition labels contain syntax that accompanies the execution of a transition. The following topics discuss creating and editing transition labels:

- “Edit Transition Labels” on page 4-14
- “Transition Label Format” on page 4-15

For more information on transition concepts, see “Transition Label Notation” on page 2-19.

For more information on transition label contents, see “Transition Action Types” on page 13-7.

Edit Transition Labels

Label unlabeled transitions as follows:

- 1 Select (left-click) the transition.

The transition changes to its highlight color and a question mark (?) appears on the transition. The ? character is the default empty label for transitions.

- 2 Left-click the ? to edit the label.

You can now type a label.

To apply and exit the edit, deselect the object. To reedit the label, simply left-click the label text near the character position you want to edit.

Transition Label Format

Transition labels have the following general format:

```
event_or_message [condition]{condition_action}/transition_action
```

Specify, as appropriate, relevant names for `event_or_message`, `condition`, `condition_action`, and `transition_action`.

Label Field	Description
<code>event_or_message</code>	The event or message that causes the transition to be evaluated.
<code>condition</code>	Defines what, if anything, has to be true for the condition action and transition to take place.
<code>condition_action</code>	If the condition is true, the action specified executes and completes.
<code>transition_action</code>	This action executes after the source state for the transition is exited but before the destination state is entered. Transition actions are supported only in Stateflow charts in Simulink models.

Transitions do not need labels. You can specify some, all, or none of the parts of the label. Rules for writing valid transition labels include:

- Can have any alphanumeric and special character combination, with the exception of embedded spaces
- Cannot begin with a numeric character
- Can have any length
- Can have carriage returns in most cases
- Must have an ellipsis (...) to continue on the next line

Move Transitions

You can move transition lines with a combination of several individual movements. These movements are described in the following topics:

- "Bow the Transition Line" on page 4-15
- "Move Transition Attach Points" on page 4-16
- "Move Transition Labels" on page 4-16

In addition, transitions move along with the movements of states and junctions.

Bow the Transition Line

You can move or "bow" transition lines with the following procedure:

- 1 Place your pointer on the transition at any point along the transition except the arrow or attach points.
- 2 Click and drag your pointer to move the transition point to another location.

Only the transition line moves. The arrow and attachment points do not move.
- 3 Release the mouse button to specify the transition point location.

The result is a bowed transition line. Repeat the preceding steps to move the transition back into its original shape or into another shape.

Move Transition Attach Points

You can move the source or end points of a transition to place them in exact locations as follows:

- 1 Place your pointer over an attach point until it changes to a small circle.
- 2 Click and drag your pointer to move the attach point to another location.
- 3 Release the mouse button to specify the new attach point.

The appearance of the transition changes from a solid to a dashed line when you detach and release a destination attach point. Once you attach the transition to a destination, the dashed line changes to a solid line.

The appearance of the transition changes to a default transition when you detach and release a source attach point. Once you attach the transition to a source, the appearance returns to normal.

Move Transition Labels

You can move transition labels to make the Stateflow chart more readable. To move a transition label, do the following:

- 1 Click and drag the label to a new location.
- 2 Release the left mouse button.

If you mistakenly click and then immediately release the left mouse button on the label, you will be in edit mode for the label. Press the **Esc** key to deselect the label and try again. You can also click an empty location in the chart to deselect the label.

Change Transition Arrowhead Size

The arrowhead size is a property of the destination object. Changing one of the incoming arrowheads of an object causes all incoming arrowheads to that object to be adjusted to the same size. The arrowhead size of any selected transitions, and any other transitions ending at the same object, is adjusted.

To adjust arrowhead size:

- 1 Select the transitions whose arrowhead size you want to change.
- 2 Place your pointer over a selected transition and right-click to select **Arrowhead Size**.
- 3 Select an arrowhead size from the menu.

Create Self-Loop Transitions

A self-loop transition is a transition whose source and destination are the same state or junction. To create a self-loop transition:

- 1 Create the transition by clicking and dragging from the source state or junction.
- 2 Press the **S** key or right-click your mouse to enable a curved transition.
- 3 Continue dragging the transition tip back to a location on the source state or junction.

For the semantics of self-loops, see “Self-Loop Transitions” on page 2-24.

Create Default Transitions

A default transition is a transition with a destination (a state or a junction), but no apparent source object.

Click the **Default Transition** button  in the toolbar and click a location in the drawing area close to the state or junction you want to be the destination for the default transition. Drag your pointer to the destination object to attach the default transition.

The size of the endpoint of the default transition is proportional to the arrowhead size. See “Change Transition Arrowhead Size” on page 4-16.

Default transitions can be labeled just like other transitions. See “Label Default Transitions” on page 2-28 for an example.

Change Transition Properties

Use the Transition properties dialog box to view and change the properties for a transition. To access the dialog box for a particular transition:

- 1 Right-click the transition and select **Properties**.

The Transition properties dialog box appears.

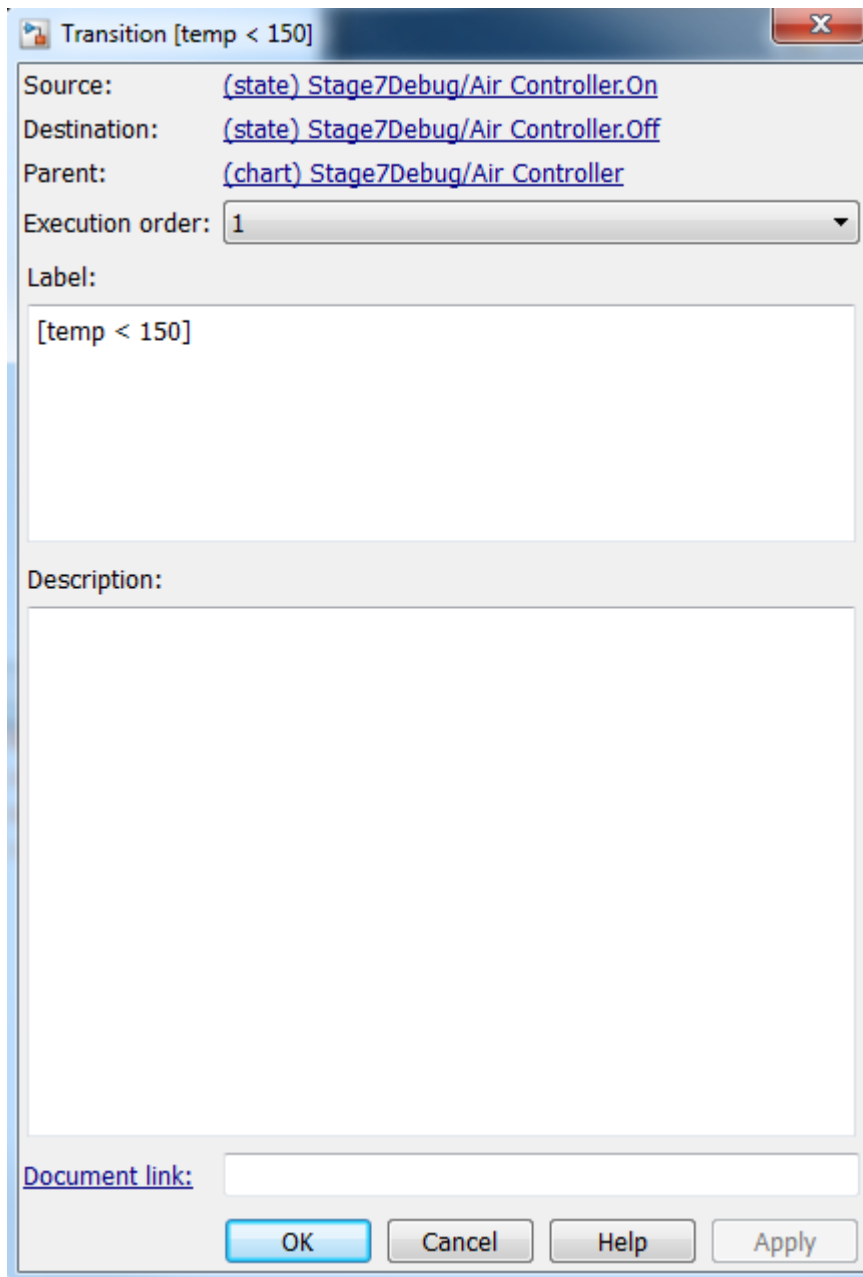

The following transition properties appear in the dialog box:

Field	Description
Source	Source of the transition; read-only; click the hypertext link to bring the transition source to the foreground.
Destination	Destination of the transition; read-only; click the hypertext link to bring the transition destination to the foreground.
Parent	Parent of this state; read-only; click the hypertext link to bring the parent to the foreground.

Field	Description
Execution order	The order in which the chart executes the transition.
Label	The transition's label. See "Transition Label Notation" on page 2-19 for more information on valid label formats.
Description	Textual description or comment.
Document link	Enter a Web URL address or a general MATLAB command. Examples are <code>www.mathworks.com</code> , <code>mailto:email_address</code> , and <code>edit/spec/data/speed.txt</code> .

- 2 After making changes, click one of these buttons:
- **Apply** to save the changes and keep the Transition dialog box open.
 - **Cancel** to return to the previous settings for the dialog box.
 - **OK** to save the changes and close the dialog box.
 - **Help** to display Stateflow online help in an HTML browser window.

See Also

Transitions

More About

- "Transition Action Types" on page 13-7
- "Default Transitions" on page 2-28
- "Inner Transitions" on page 2-25
- "Self-Loop Transitions" on page 2-24

Stateflow Editor Operations

Stateflow Editor

Use the Stateflow Editor to draw, zoom, modify, print, and save a chart shown in the window.

Opening a Stateflow chart displays the chart in the Stateflow Editor.

To open a new Stateflow chart in the Stateflow Editor:

- 1 At the MATLAB command prompt, enter:

Command	Result
<code>sfnew</code>	Creates a chart with the default action language. For more information, see <code>sfnew</code> .
<code>sfnew -matlab</code>	Creates an empty chart with MATLAB as the action language.
<code>sfnew -C</code>	Creates an empty C chart.
<code>stateflow</code>	Creates an empty chart with the default action language and displays the Stateflow block library.

The Simulink Editor opens, with an empty chart.

- 2 Double-click the chart object.

The Stateflow Editor opens.

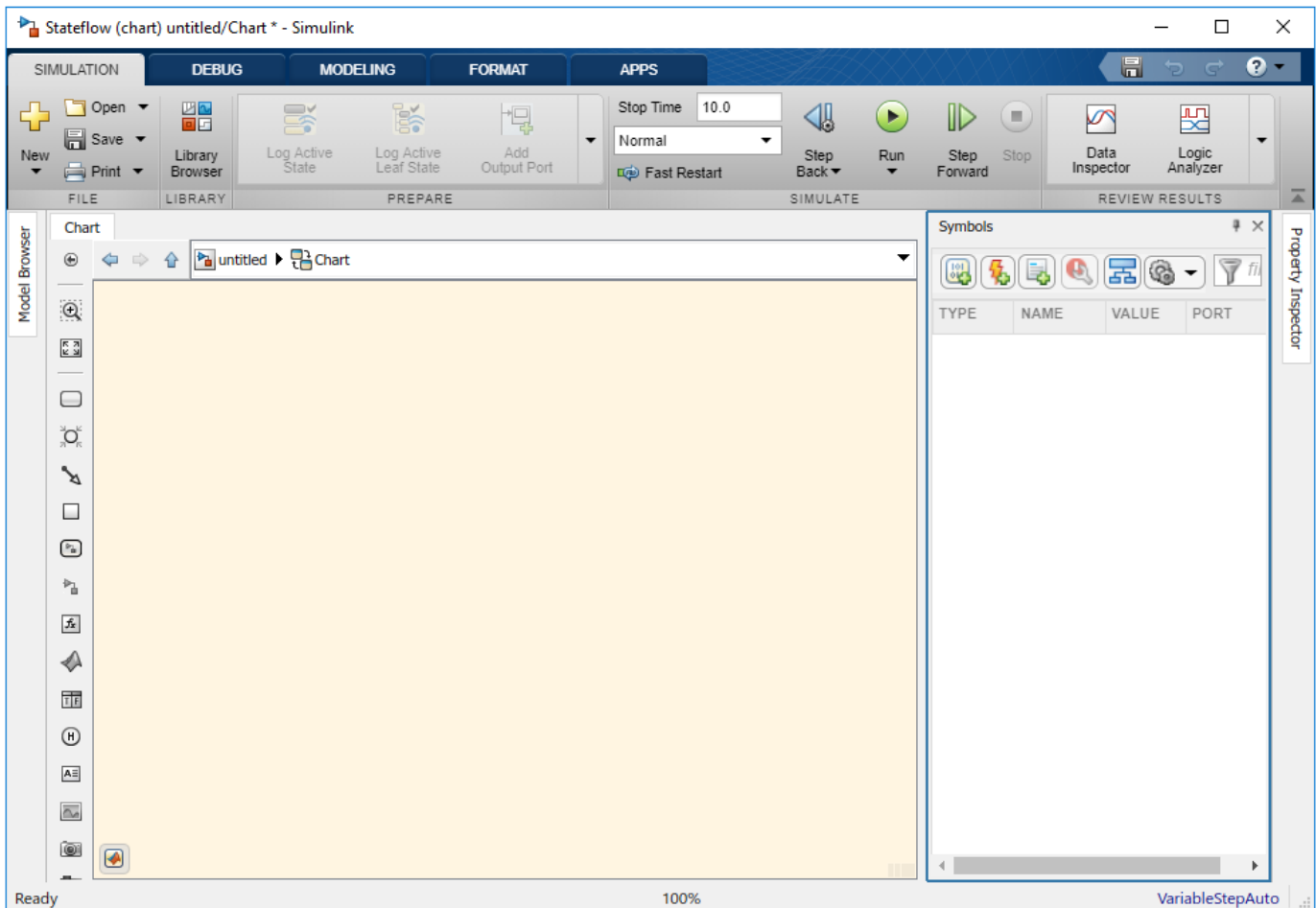

The Stateflow Editor window includes the following sections:

- **Title bar**

Stateflow (chart) untitled/Chart * - Simulink

The full chart name appears here in *model name/chart name** format. The * character appears on the end of the chart name for a newly created chart or for an existing chart that has been edited but not saved yet.

- **Toolstrip**

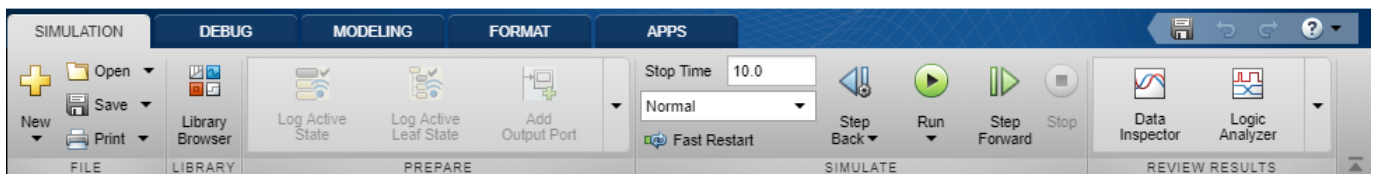

Most editor commands are available from the toolstrip. You can identify each tool of the toolbar by placing your pointer over it until an identifying tool tip appears.

- **Object palette**

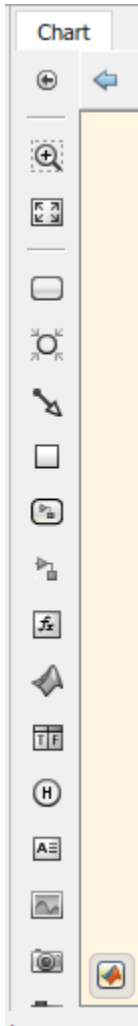

Displays a set of tools for drawing states, transitions, and other chart objects. To add an object, you can use the palette to:

- Click the icon for the object and move the cursor to the spot in the drawing area where you want to place the object.
- Drag the icon for the object into the drawing area.
- Double-click the icon and then click multiple times in the drawing area to make copies of the object.
- **Explorer bar**

untitled > Chart

The breadcrumb shows the systems that you have open in the editor. Click a system in the breadcrumb to display that system. The e also contains buttons for navigating the chart hierarchy (see “Navigate Subcharts” on page 8-6).

- **Model Browser**

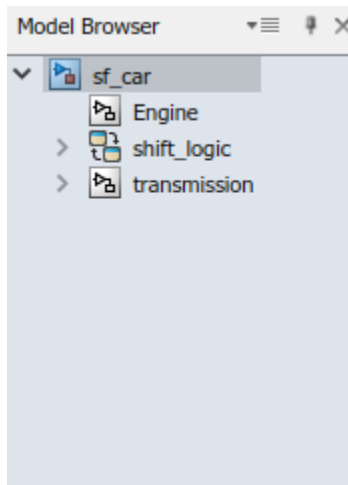

Click the double arrows  in the bottom left corner to open or close a tree-structured view of the model in the editor.

- **Drawing area** — This area displays an editable copy of a chart.
- **Context menus** (shortcut menus) — These menus pop up from the drawing area when you right-click an object. They display commands that apply only to that object. If you right-click an empty area of the chart, the context menu applies to the chart object.
- **Status information** — Near the top of the editor, you can see (and reset) the simulation time and the simulation mode. The bottom status bar displays the status of the Stateflow processing, tool tips, the zoom factor, and the solver.

Undo and Redo Editor Operations

You can undo and redo operations that you perform in a chart. When you undo an operation, you reverse the last edit operation that you performed. After you undo operations in the chart, you can also redo them one at a time.

- To undo an operation in the chart, press **Ctrl + Z**.
- To redo an operation in the chart, press **Ctrl + Y**.

You can undo and redo many operations you complete on Stateflow objects in the Symbols pane or the Property Inspector.

Exceptions for Undo

You can undo or redo all editor operations, with the following exceptions:

- You cannot undo the operation of turning subcharting off for a state previously subcharted.

To understand subcharting, see “Encapsulate Modal Logic by Using Subcharts” on page 8-4.

- You cannot undo the drawing of a supertransition or the splitting of an existing transition.

Splitting of an existing transition refers to the redirection of the source or destination of a transition segment that is part of a supertransition. For a description of supertransitions, see “Draw a Supertransition Into a Subchart” on page 8-8 and “Draw a Supertransition Out of a Subchart” on page 8-10.

- You cannot undo any changes made to the chart using the Stateflow API.

For a description of the Stateflow API, see “Stateflow Programmatic Interface”.

Note When you perform one of the preceding operations, the undo and redo buttons are disabled from undoing and redoing any prior operations.

Specify Colors and Fonts in a Chart

You can change the way Stateflow displays an individual element of a chart or specify the global display options used throughout the entire chart.

Change Size of a Single Element

To change the display size for a single element in the chart, right-click the element, and then select a new **Format** option from the context menu. The options available depend on the element that you select.

Option	States	Transitions	Junctions	Annotations	Other Elements
Font Size	Available	Available	Not Available	Available	Available
Arrowhead Size	Available	Available	Available	Not Available	Not Available
Junction Size	Not Available	Not Available	Available	Not Available	Not Available
Font Style	Not Available	Not Available	Not Available	Available	Not Available
Shadow	Not Available	Not Available	Not Available	Available	Not Available
Text Alignment	Not Available	Not Available	Not Available	Available	Not Available

Change Global Display Options

Through the **Colors & Fonts** dialog box, you can specify a color scheme for the chart or specify colors and label fonts for different types of objects in a chart. To open the **Colors & Fonts** dialog box, in the **Format** tab, click **Style**.

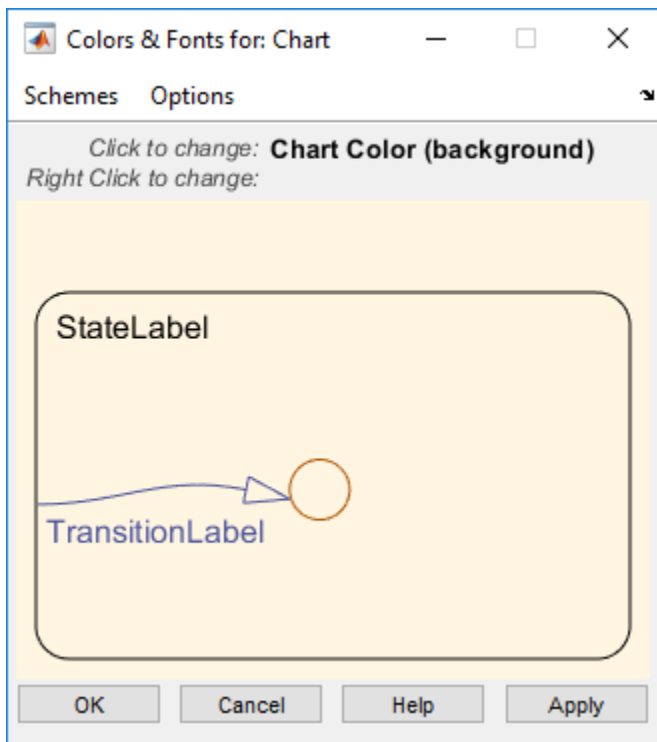

In the **Colors & Fonts** dialog box, the drawing area displays examples of the colors and label fonts specified by the current color scheme for the chart. You can choose a different color scheme from the **Schemes** menu. To modify the display options for a single type of chart element, position your pointer over the sample object.

- To change the color of the element, click the sample object and select a new color in the dialog box.

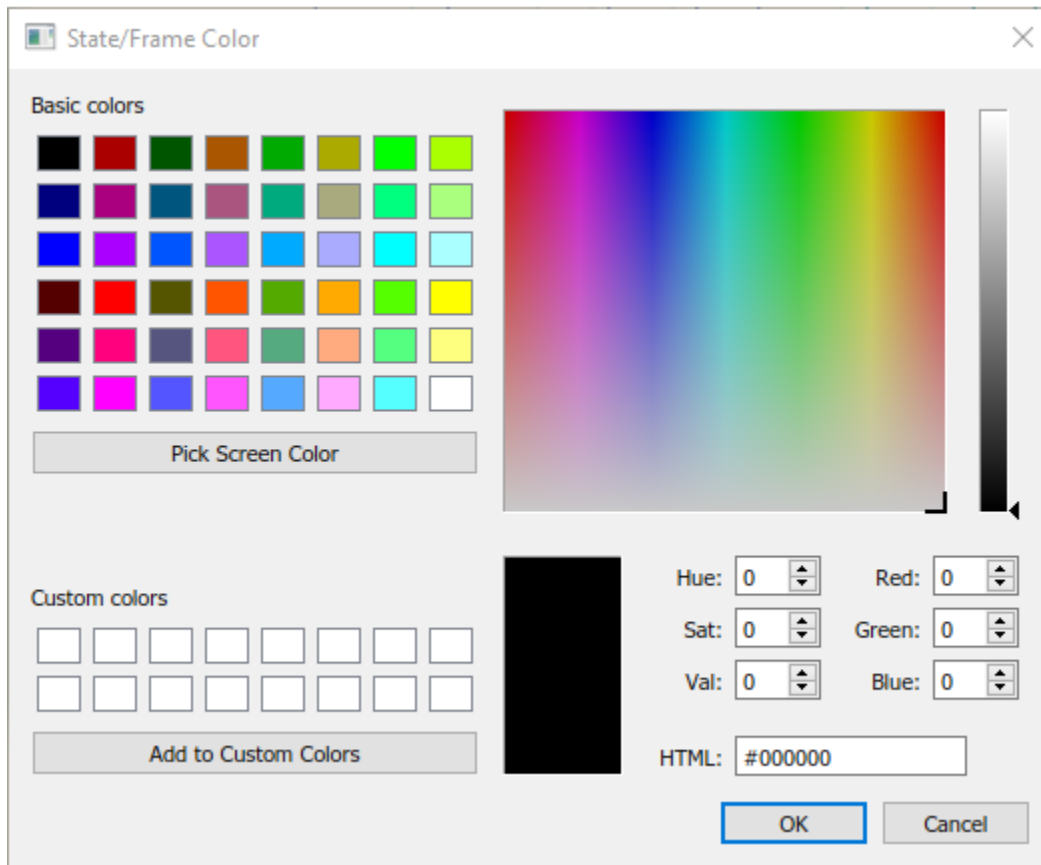

- To change the font of the element, right-click the sample object and select a new font, style, or size in the dialog box.

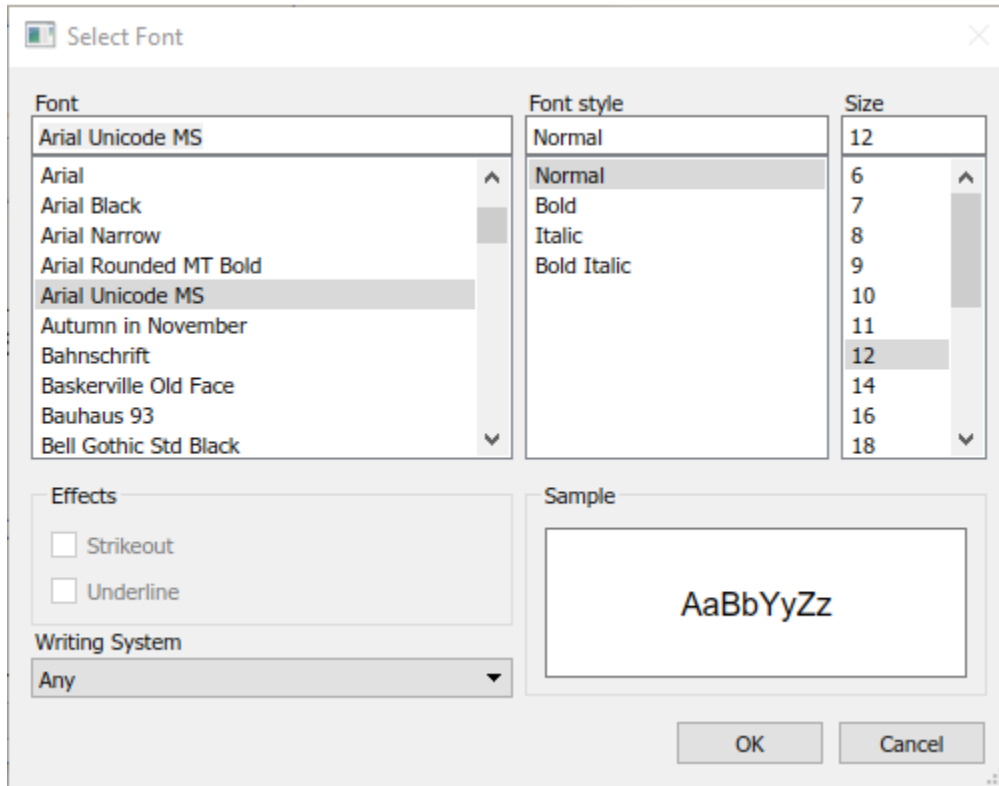

To apply the scheme to the chart, click **Apply**. To apply the scheme and close the dialog box, click **OK**.

To make the scheme the default scheme for all charts, select **Options > Make this the 'Default' scheme**.

To save changes to the default color scheme, select **Options > Save defaults to disk**. If the modified scheme is not the default scheme, choosing **Save defaults to disk** has no effect.

Content Preview for Stateflow Objects

When a chart is closed, you can preview the content of Stateflow charts in Simulink. You can see an outline of the contents of a chart. During simulation, you can see chart animation. When a chart is open, you can preview the content of subcharts and Simulink functions.

For example, the Temporal Logic chart uses content preview. The chart Without Temporal Logic does not.

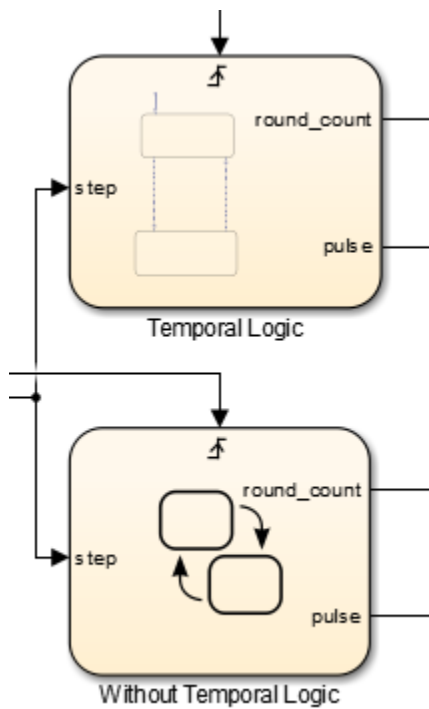

To turn on content preview for Stateflow charts and subcharts, right-click the chart and select **Format > Content Preview**. For Simulink functions, right-click the function and select **Content Preview**. For details on content preview in Simulink, see “Preview Content of Model Components” (Simulink).

Note In order to see the content preview, you may need to enlarge the Stateflow chart or object.

Intelligent Tab Completion for Stateflow Charts

Stateflow tab completion provides context-sensitive editing assistance. Tab completion helps you avoid typographical errors. It also helps you quickly select syntax-appropriate options for keywords, data, event, messages, and function names, without having to navigate the Model Explorer. In a Stateflow chart, to complete entries:

- 1 Type the first few characters of the word that you want.
- 2 Press **Tab** to see the list of possible matches.
- 3 Use the arrow keys to select a word.
- 4 Press **Tab** to make the selection.

Additionally, you can:

- Close the list without selecting anything by pressing the **Esc** key.
- Type additional characters onto your original term to narrow the list of possible matches.

If you press **Tab** and no words are listed, then the current word is the only possible match.

Differentiate Elements of Action Language Syntax

You can use color highlighting to differentiate the following syntax elements:

- Keyword
- Comment
- Event
- Message
- Function
- String
- Number

Syntax highlighting is a user preference, not a model preference.

Default Syntax Highlighting

The following chart illustrates the default highlighting for language elements.

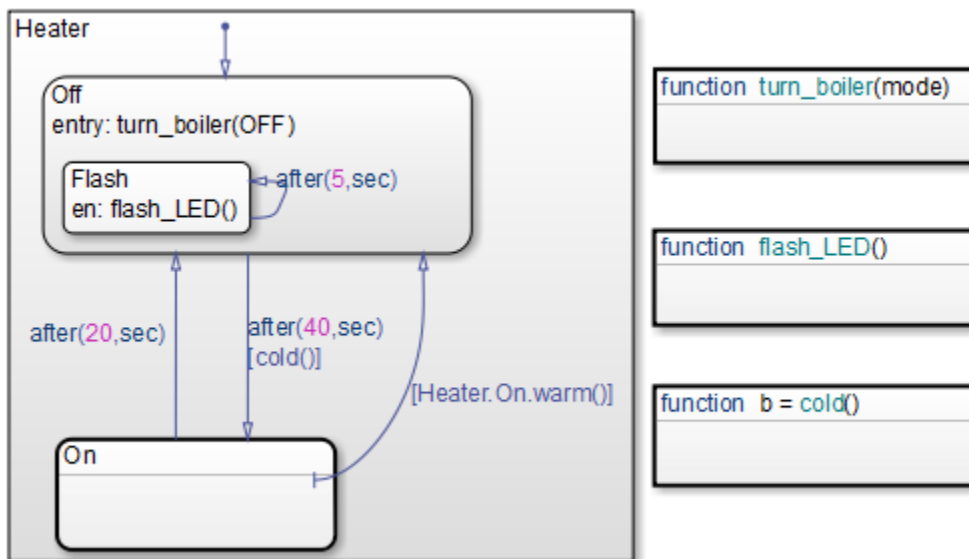

If the parser cannot resolve a syntax element, the chart displays the element in the default text color.

To modify color assignments, see “Edit Syntax Highlighting” on page 4-29. To disable syntax highlighting, see “Enable and Disable Syntax Highlighting” on page 4-30.

Edit Syntax Highlighting

- 1 In the Stateflow Editor, in the **Format** tab, click **Style > Syntax Highlighting**.

The Syntax Highlight Preferences dialog box appears.

- 2 Click the color that you want to change, choose an alternative from the color palette, and click **Apply**.
- 3 Click **OK** to close the Syntax Highlight Preferences dialog box.

Enable and Disable Syntax Highlighting

- 1 In the Stateflow Editor, in the **Format** tab, click **Style > Syntax Highlighting**.

The Syntax Highlight Preferences dialog box appears.

- 2 Select or clear **Enable syntax highlighting** and click **OK**.

Select and Deselect Graphical Objects

Once an object is in the drawing area, to make any changes or additions to that object, select it.

- To select an object, click anywhere inside of the object.
- To select multiple adjacent objects, click and drag a selection box so that the box encompasses or touches the objects that you want to select, and then release the mouse button.

All objects or portions of objects within the box become selected.

- To select multiple separate objects, simultaneously press the **Shift** key and click an object or box a group of objects.

This step adds objects to the list of already selected objects unless an object was already selected, in which case, the object is deselected. This type of multiple object selection is useful for selecting objects within a state without selecting the state itself.

- To deselect all selected objects, click in the drawing area, but not on an object.

When an object is selected, it appears highlighted in the color set as the selection color (blue by default; see “Specify Colors and Fonts in a Chart” on page 4-24 for more information).

Cut and Paste Graphical Objects

You can cut objects from the drawing area or cut and then paste them as many times as you like. You can cut and paste objects from one chart to another. The chart retains a selection list of the most recently cut objects. The objects are pasted in the drawing area location closest to the current pointer location.

- To cut an object, right-click the object and select **Cut** from the context menu.
- To paste the most recently cut selection of objects, right-click in the chart and select **Paste** from the context menu.

Copy Graphical Objects

To copy and paste an object in the drawing area, select the objects and right-click and drag them to the desired location in the drawing area. This operation also updates the chart clipboard.

Note If you copy and paste a state in the chart, these rules apply:

- If the original state uses the default ? label, then the new state retains that label.
 - If the original state does not use the default ? label, then a unique name is generated for the new state.
-

Alternatively, to copy from one chart to another, select **Copy** and then **Paste** from the right-click context menu.

Comment Out Objects

To Comment Out a Stateflow object, right-click the selected object and select **Comment Out**. For more information, see “Commenting Stateflow Objects in a Chart” on page 33-56.

Format Chart Objects

To enhance readability of objects in a chart, in the Stateflow Editor you can use commands in the **Format** tab. These commands include options for:

- Alignment
- Distribution
- Resizing

You can align, distribute, or resize these chart objects:

- States
- Functions
- Boxes
- Junctions

Some of these options appear only after selecting elements within your chart.

Align, Distribute, and Resize Chart Objects

The basic steps to align, distribute, or resize chart objects are similar.

- 1 If the chart includes parallel states or outgoing transitions from a single source, make sure that the chart uses explicit ordering.

To set explicit ordering, in the Chart properties dialog box, select **User-specified state/transition execution order**.

Note If a chart uses implicit ordering to determine execution order of parallel states or evaluation order of outgoing transitions, the order can change after you align, distribute, or resize chart objects. Using explicit ordering prevents this change from occurring. For more information, see “Execution Order for Parallel States” on page 3-58 and “Transition Evaluation Order” on page 3-38.

- 2 Select the chart objects that you want to align, distribute, or resize.

You can select objects in any order, one-by-one or by drawing a box around them.

- 3 Decide which object to use as the anchor for aligning, distributing, or resizing other chart objects. This object is the reference object.

To set an object as the reference, right-click the object. Brackets appear around the reference object. In the following example, the **Door** and **Motion** states are selected, and the **Door** state is the reference.

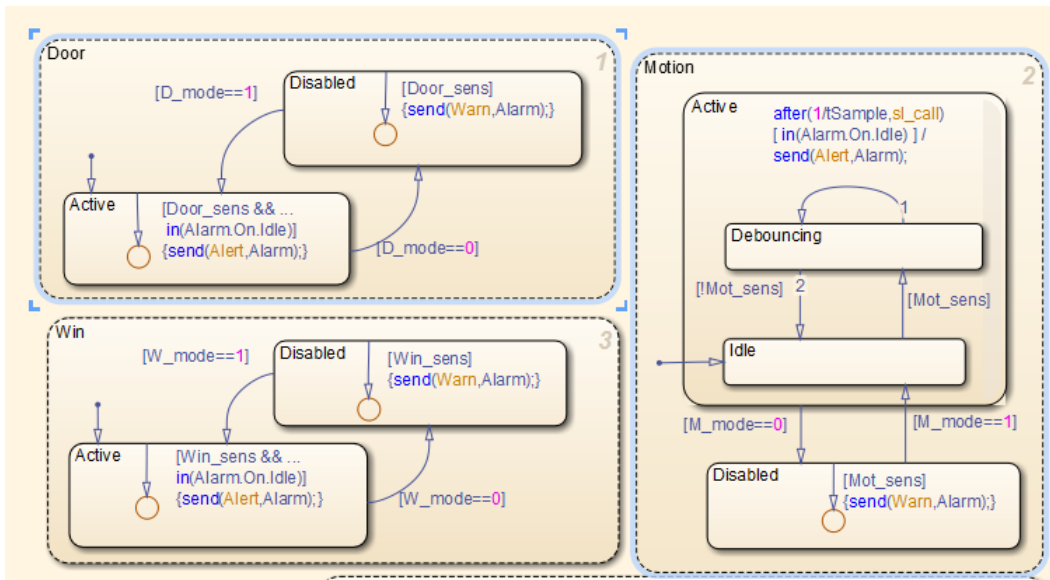

Note If you select objects one-by-one, the last object that you select acts as the reference.

- 4 Select an option from the **Format** tab to align, distribute, or resize your chosen objects.

For more information about chart object distribution options, see “Options for Distributing Chart Objects” on page 4-32

Options for Distributing Chart Objects

Option	Description
Distribute Horizontally	<p>The center-to-center horizontal distance between any two objects is the same.</p> <p>Note The horizontal space for distribution is the distance between the left edge of the leftmost object and the right edge of the rightmost object. If the total width of the objects you select exceeds the horizontal space available, objects can overlap after distribution.</p>
Distribute Vertically	<p>The center-to-center vertical distance between any two objects is the same.</p> <p>Note The vertical space for distribution is the distance between the top edge of the highest object and the bottom edge of the lowest object. If the total height of the objects you select exceeds the vertical space available, objects can overlap after distribution.</p>

Option	Description
Even Horizontal Gaps	The horizontal white space between any two objects is the same. Note The space restriction for Distribute Horizontally applies.
Even Vertical Gaps	The vertical white space between any two objects is the same. Note The space restriction for Distribute Vertically applies.

Example of Aligning Chart Objects

Suppose that you open the sf_pool model and see a chart with multiple MATLAB functions.

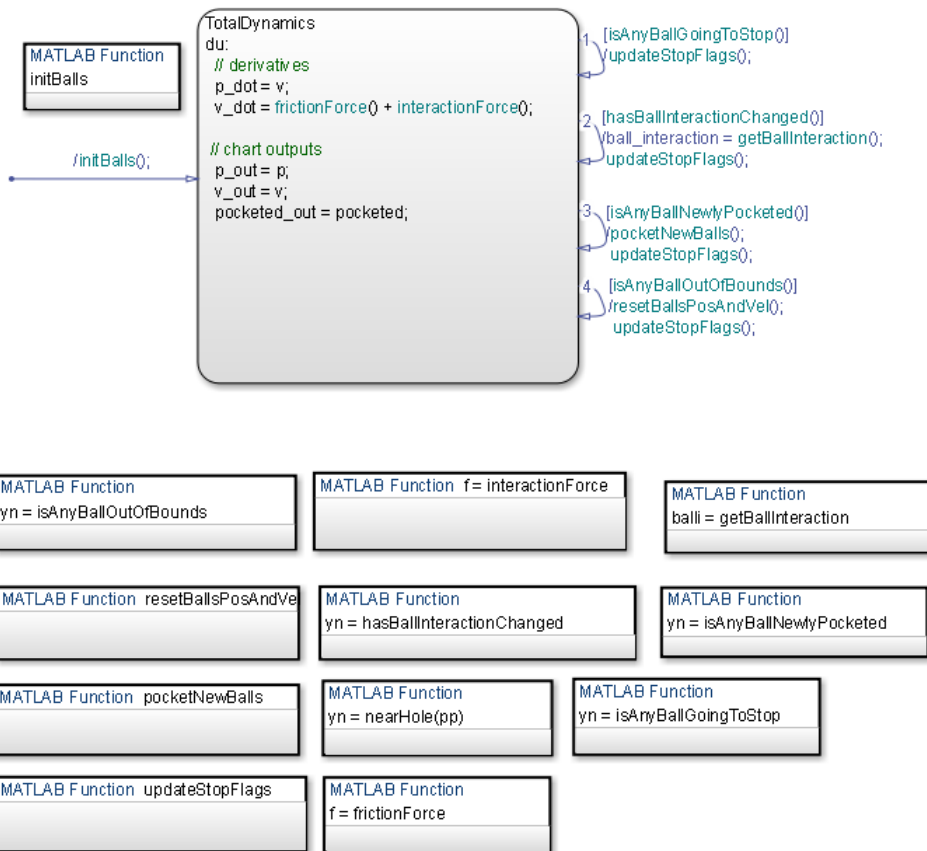

To align the three MATLAB functions on the right:

- 1 Open the sf_pool model. Double-click the Pool block to open the chart.

Tip Expand the Stateflow Editor to see the entire chart.

- 2 Click the function `isAnyBallGoingToStop`.
- 3 Shift-click the function `isAnyBallNewlyPocketed`.
- 4 Shift-click the function `getBallInteraction`.

This object is the reference (or anchor) for aligning the three functions. Brackets appear around the function.

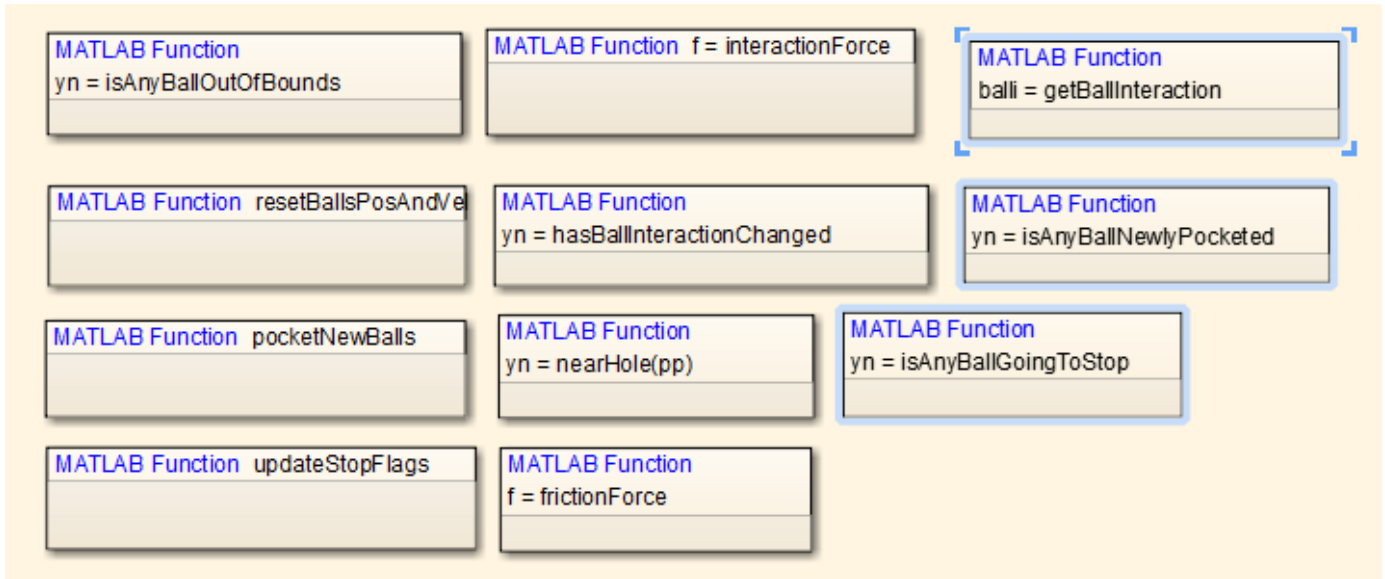

- 5 In the Format tab, click Align Right.

This step aligns the right edges of the three functions based on the right edge of `getBallInteraction`.

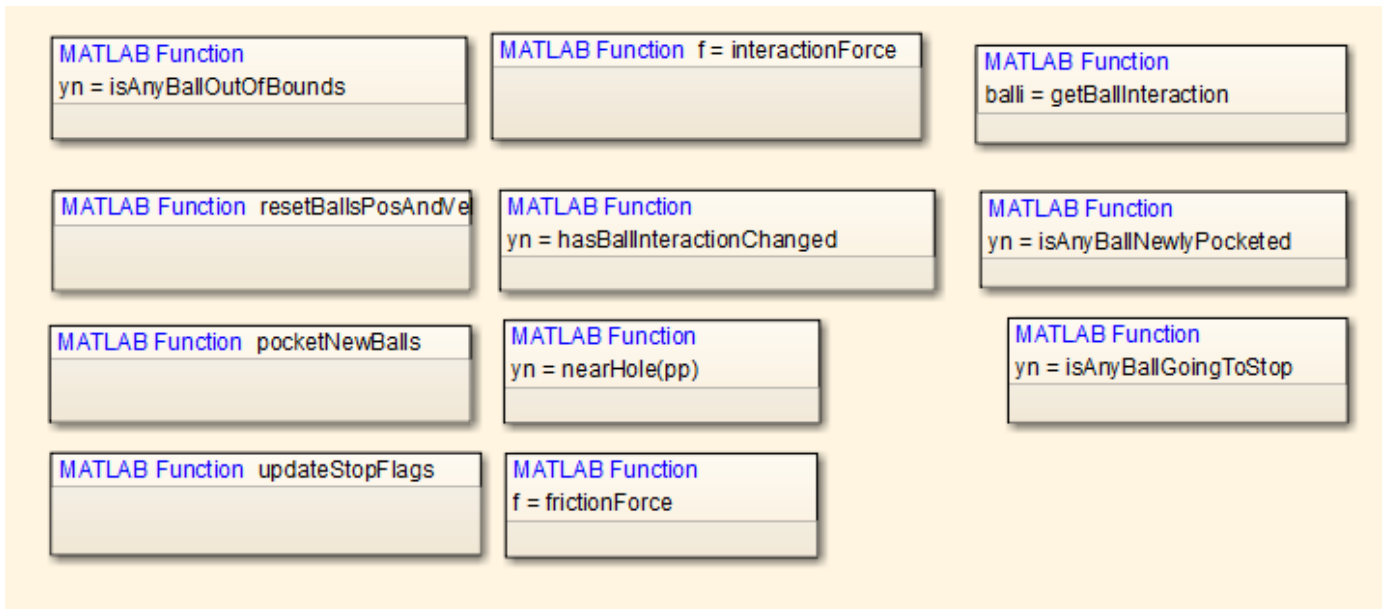

Example of Distributing Chart Objects

Suppose that you open the `sf_frame_sync_controller` model and see a chart with three states.

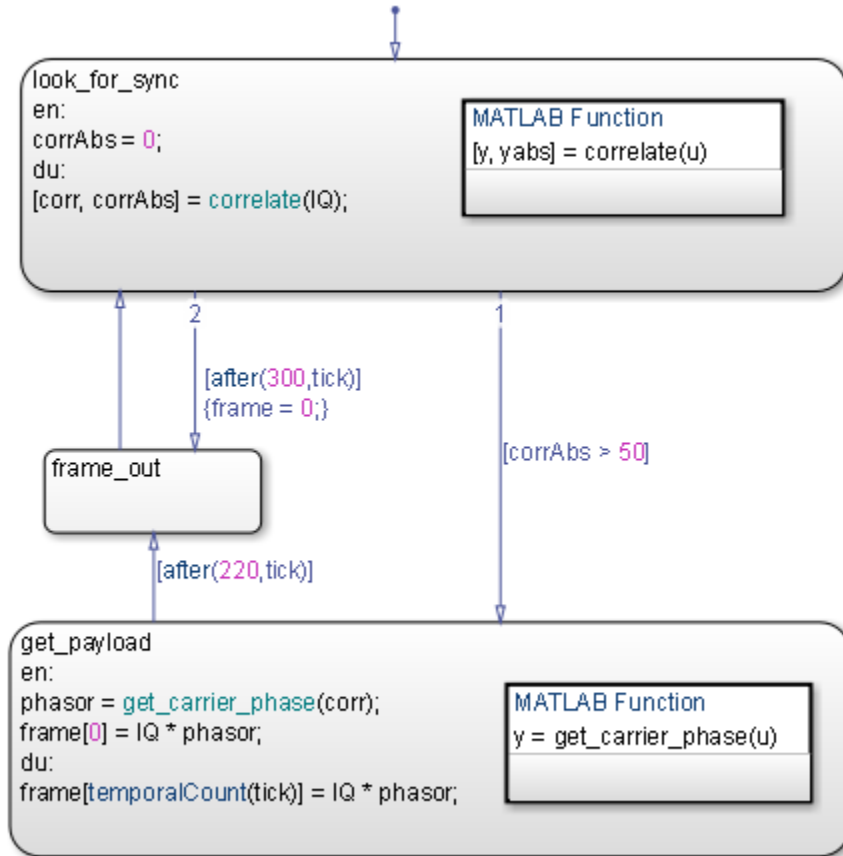

To distribute the three states vertically:

- 1 Open the `sf_frame_sync_controller` model.

Tip Double-click the Frame Sync Controller block to open the chart.

- 2 Select the three states in any order.

Shift-click to select more than one state.

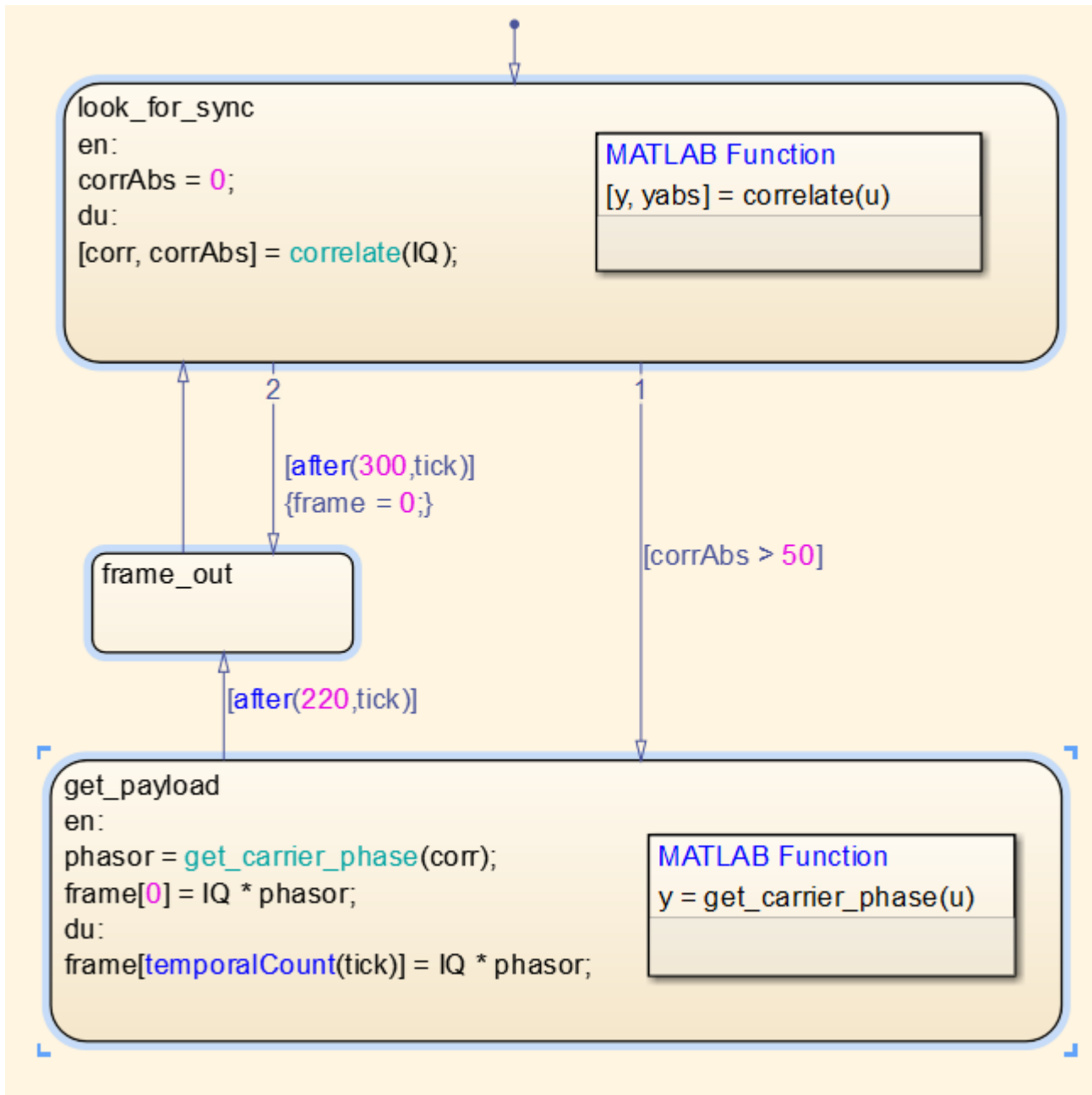

Note When you select the three states in any order, your reference object might differ from the one shown. This difference does not affect distribution of vertical white space.

- 3 In the **Format** tab, click **Even Vertical Gaps** .

This step ensures that the vertical white space between any two states is the same.

Example of Resizing Chart Objects

Suppose that you open the `sf_clutch_enabled_subsystems` model and see a chart with graphical functions of different sizes.

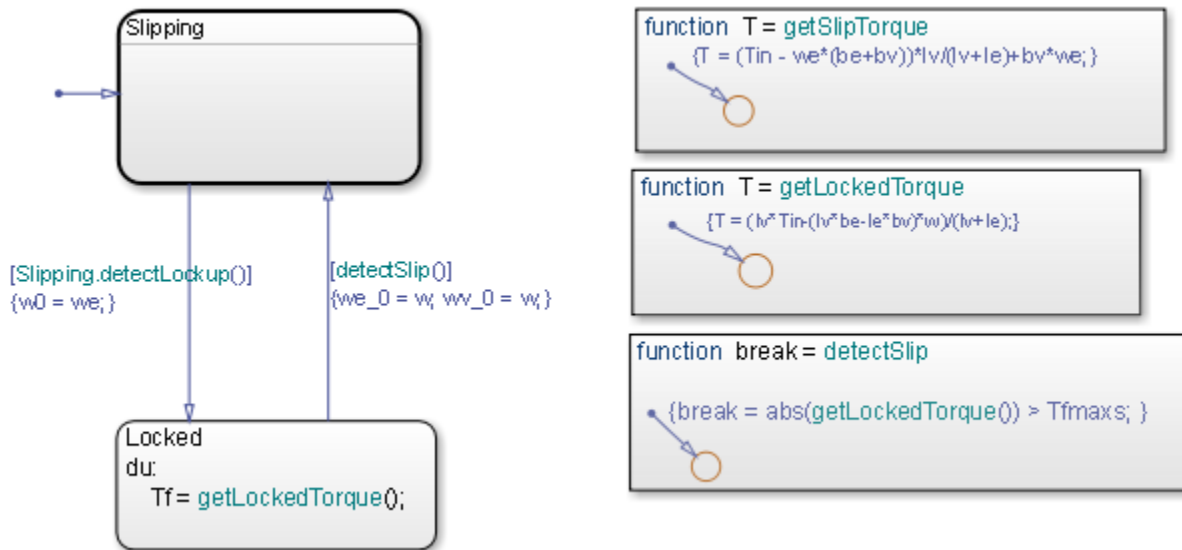

To resize the graphical functions so that they all match the size of `detectSlip`:

- 1 Open the `sf_clutch_enabled_subsystems` model.
- 2 In the Friction Mode chart, select the three graphical functions by drawing a box around them.
- 3 Set `detectSlip` as the reference object to use for resizing.

Right-click the function to mark it with brackets.

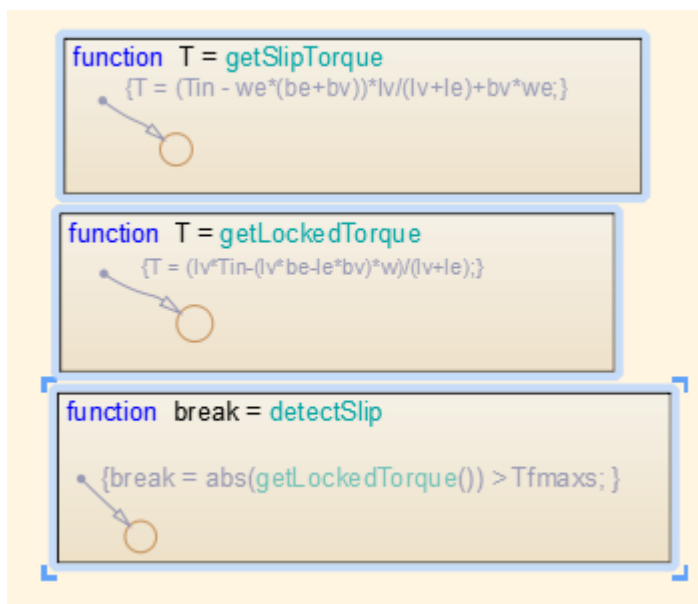

- 4 In the **Format** tab, click **Match Size** .

This step ensures that the three functions are the same size.

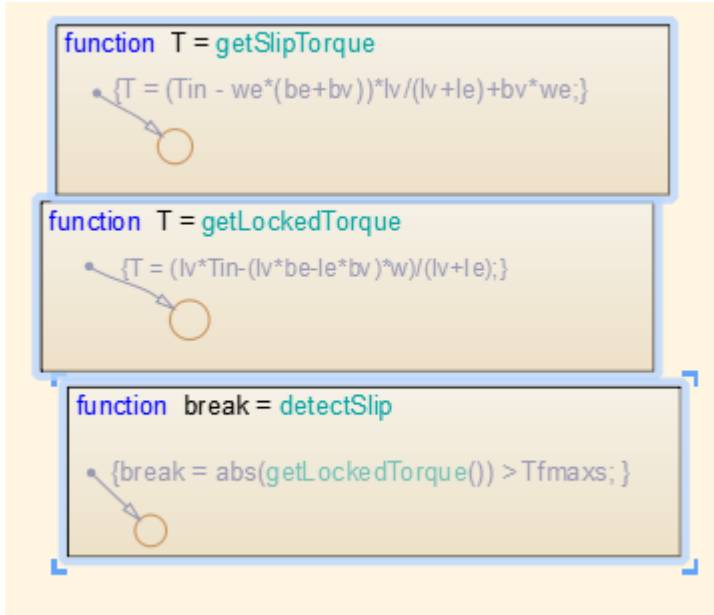

- 5 Adjust the function boxes to correct the format:

- a In the **Format** tab, click **Align Left** .

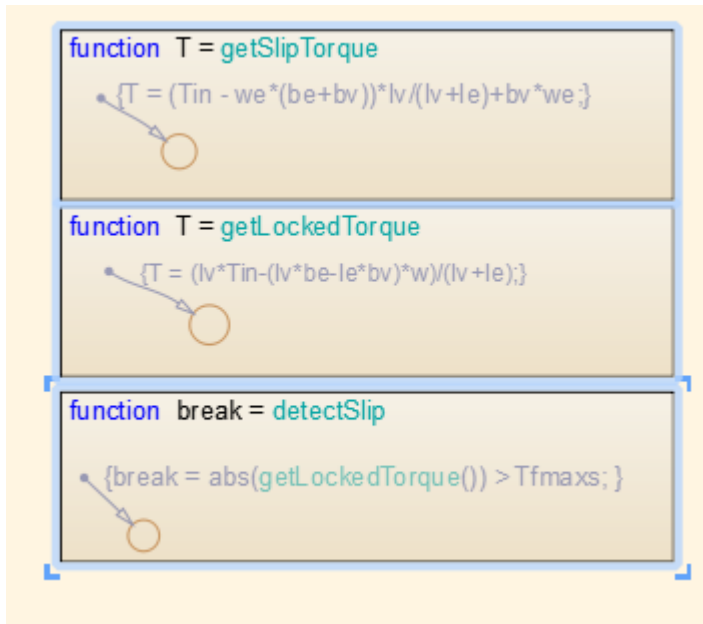

- b In the **Format** tab, click **Even Vertical Gaps** .

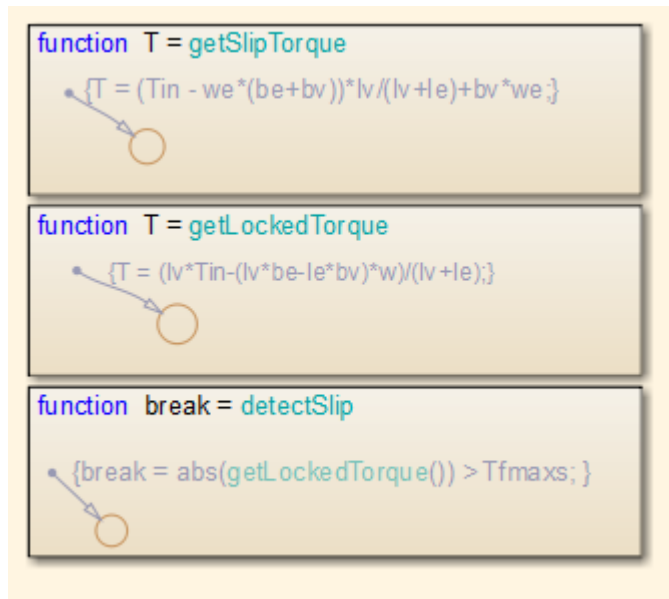

Automatic Chart Formatting

With Arrange Automatically, Stateflow arranges your charts to:

- Expand states and transitions to fit their label strings.
- Resize similar states to be the same size.
- Align states if they were slightly misaligned.
- Straightens transitions.
- Repositions horizontal transition labels to the midpoint.

In the **Format** tab, click **Auto Arrange**.

In this example, the chart has:

- 1 State actions that are outside of the boundary for state A.
- 2 A transition condition that overlaps state B.
- 3 A transition that is not horizontal.

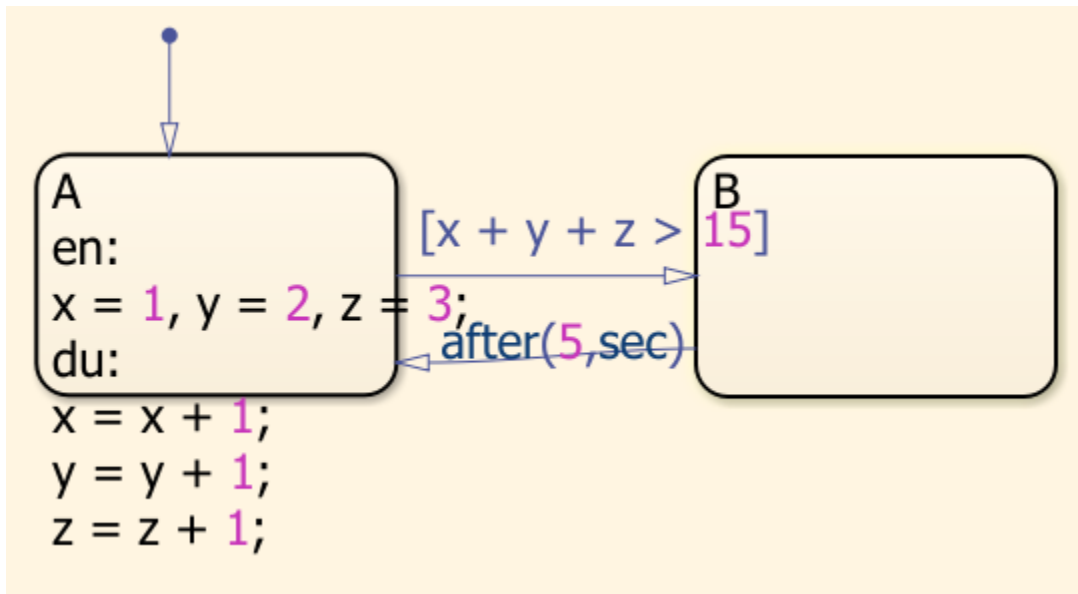

After the layout has been automatically arranged:

- 1 The state actions are contained within state A.
- 2 The transition condition does not overlap into state B.
- 3 The lower transition is horizontal.

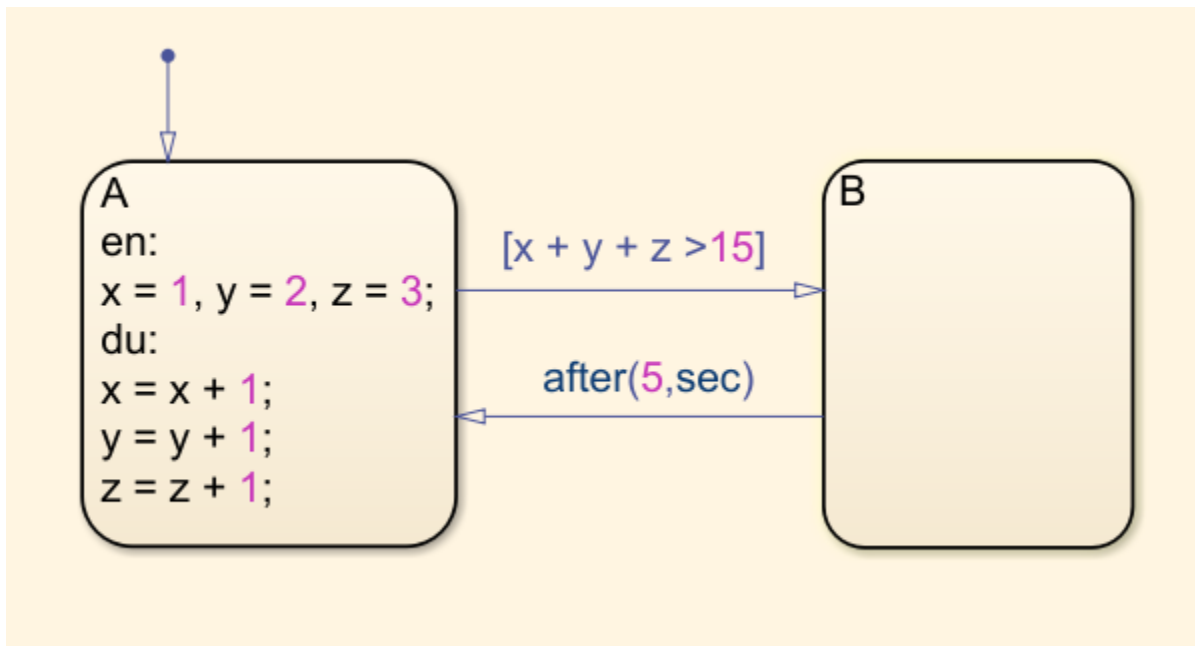

Generate a Model Report

The **Print Details** report is an extension of the **Print Details** report in the Simulink model window. It provides a report of Stateflow and Simulink objects relative to the chart currently in view from which you select the report.

To generate a model report on chart objects:

- 1 Open the chart or subchart for which you want a report.
- 2 In the **Simulation** tab, select **Print > Print Details**.

The Print Details dialog box appears.

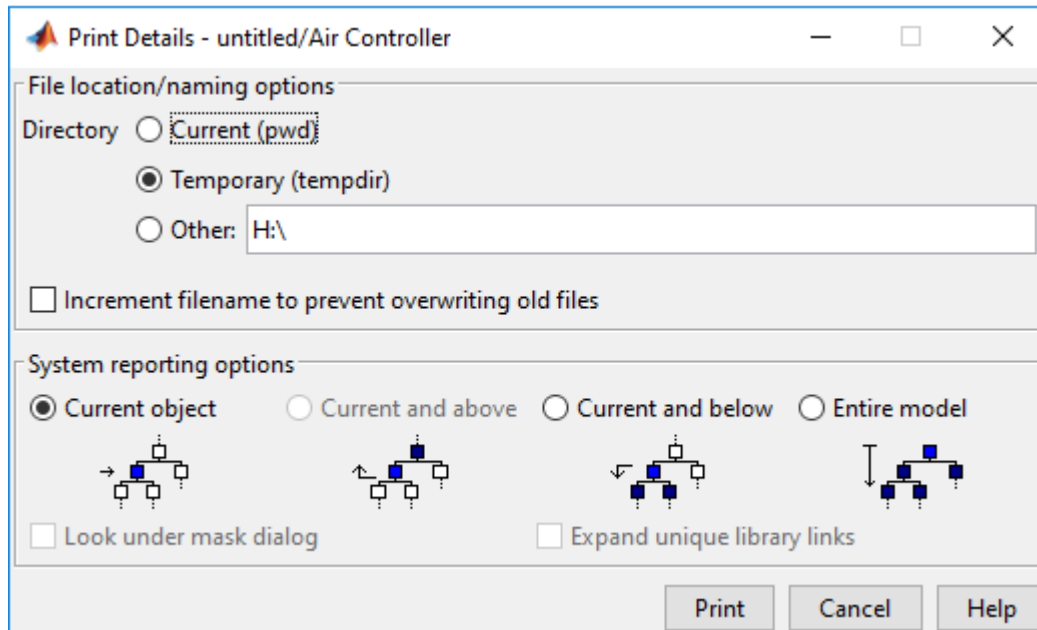

- 3 Enter the destination directory of the report file and select options to specify what objects appear in the report.

For details on setting the fields in the **File locations/naming options** section, see “Print Model Reports” (Simulink). For details on the report you receive, see “System Report Options” on page 4-41 and “Report Format” on page 4-42.

- 4 Click **Print**.

The Print Details dialog box appears and tracks the report generation. See “Print Model Reports” (Simulink) for more details on this window.

The HTML report appears in your default browser.

Tip If you have the Simulink Report Generator™ installed, you can generate a detailed report about a system. To do so, in the **Modeling** tab, under **Design**, select **System Design Report**. For more information, see “System Design Description” (Simulink Report Generator).

System Report Options

Reports for the current Stateflow chart vary with your choice of one of the **System reporting options** fields:

- **Current** — Reports on the chart or subchart in the current editor window and its immediate parent Simulink system.

- **Current and above** — This option is grayed out and unavailable for printing chart details.
- **Current and below** — Reports on the chart or subchart in the current editor window and all contents at lower levels of the hierarchy, along with the immediate Simulink system.
- **Entire model** — Reports on the entire model including all charts and all Simulink systems.

If you select this option, you can modify the report as follows:

- **Look under mask dialog** - Includes the contents of masked subsystems in the report.
- **Expand unique library links** - Includes the contents of library blocks that are subsystems in the report.

The report includes a library subsystem only once even if it occurs in more than one place in the model.

Report Format

The general top-down format of the **Print Details** report is as follows:

- The report shows the title of the system in the Simulink model containing the chart or subchart in current view.
- A representation of Simulink hierarchy for the containing system and its subsystems follows. Each subsystem in the hierarchy links to the report of its Stateflow charts.
- The report section for the Stateflow charts of each system or subsystem begins with a small report on the system or subsystem, followed by a report of each contained chart.
- Each chart report includes a reproduction of its chart with links for subcharted states that have reports of their own.
- An appendix tabulates the covered Stateflow and Simulink objects in the report.

Model Logic Patterns and Iterative Loops Using Flow Charts

- “Flow Charts in Stateflow” on page 5-2
- “Create Flow Charts by Using Pattern Wizard” on page 5-5
- “Convert MATLAB Code into Stateflow Flow Charts” on page 5-18

Flow Charts in Stateflow

A Stateflow flow chart is a graphical construct that models logic patterns such as decision trees and iterative loops. Flow charts represent combinatorial logic in which one result does not depend on prior results. You build flow charts by combining connective junctions and transitions without using any states. The junctions provide decision branches between different transition paths. Executing a flow chart begins at a default transition and ends at a terminating junction (a junction that has no valid outgoing transitions).

A best practice is to encapsulate flow charts in graphical functions to create modular and reusable logic that you can call anywhere in a chart. For more information about graphical functions, see “Reuse Logic Patterns by Defining Graphical Functions” on page 8-13.

An example of a flow chart that models simple **If-Else** logic:

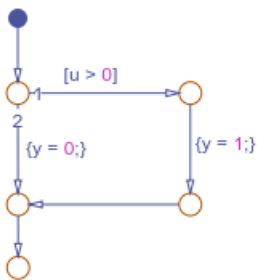

The flow chart models this code:

```
if u > 0
    y = 1;
else
    y = 0;
end
```

Draw a Flow Chart

You can draw and customize flow charts manually by using connective junctions as branch points between alternate transition paths:

- 1 Open a chart.
- 2 From the editor toolbar, drag one or more connective junctions into the chart with the **Connective Junction** tool:



- 3 Add transition paths between junctions.
- 4 Label the transitions.
- 5 Add a default transition to the junction where the flow chart execution starts.

Best Practices for Creating Flow Charts

Follow these best practices to create efficient, accurate flow charts:

Use only one default transition

Flows charts have a single entry point.

Provide only one terminating junction

Multiple terminating junctions reduce readability of a flow chart.

Converge all transition paths to the terminating junction

Execution of a flow chart always reaches the termination point.

Provide an unconditional transition from every junction except the terminating junction

If unintended backtracking occurs during simulation, a warning message appears.

You can control the level of diagnostic action for unintended backtracking in the **Diagnostics > Stateflow** pane of the Model Configuration Parameters dialog box. For more information, see the documentation for the "Unexpected backtracking" (Simulink) diagnostic.

Unintended backtracking can occur at a junction under these conditions:

- The junction does not have an unconditional transition path to a state or terminating junction.
- Multiple transition paths lead to that junction.

Use condition actions to process updates, not transition actions

Flow charts test transitions, but do not execute them (and, therefore, never execute transition actions).

An example that illustrates these best practices:

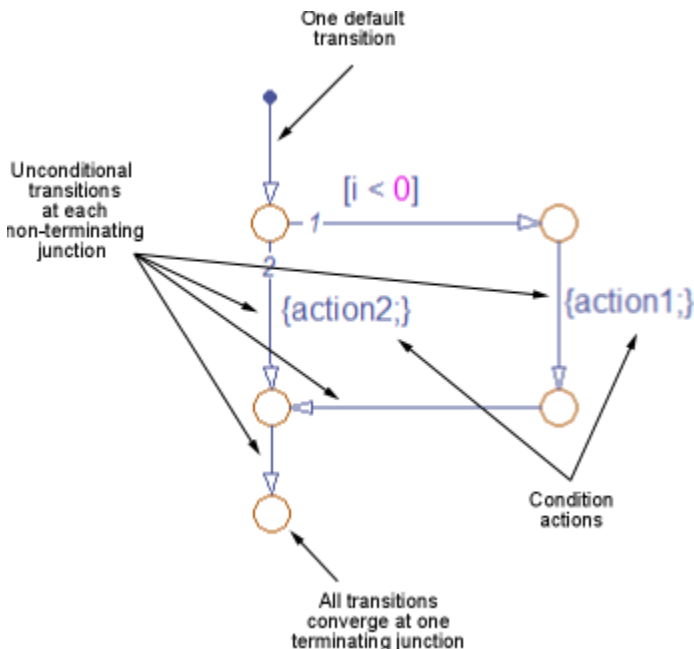

See Also

More About

- “Create Flow Charts by Using Pattern Wizard” on page 5-5
- “Reuse Logic Patterns by Defining Graphical Functions” on page 8-13
- “Convert MATLAB Code into Stateflow Flow Charts” on page 5-18
- “How Stateflow Objects Interact During Execution” on page 3-5

Create Flow Charts by Using Pattern Wizard

The Pattern Wizard is a utility that generates common flow chart patterns for use in graphical functions and charts. The Pattern Wizard offers several advantages over manually creating flow charts. The Pattern Wizard:

- Generates common logic and iterative loop patterns.
- Promotes consistency in geometry and layout across patterns.
- Facilitates storing and reusing patterns from a central location.
- Allows inserting patterns in an existing flow chart.

The Pattern Wizard generates flow charts whose geometry and layout comply with the guidelines from the MathWorks Advisory Board (MAB). You can customize your flow chart by modifying the conditions and actions or by inserting additional logic patterns. You can also save your flow chart as a custom pattern in the Pattern Wizard for later reuse.

For example, suppose that you want to use the Pattern Wizard to create a graphical function for iterating over the upper triangle of a two-dimensional matrix. The function consists of two nested for loops in which the row index i is always less than or equal to the column index j . By using the Pattern Wizard, you can:

- 1 Create a flow chart for the outer loop that iterates over the row index i . See “Create Reusable Flow Charts” on page 5-5.
- 2 Extend the flow chart by inserting an inner loop that iterates over the column index j . See “Insert Logic Patterns in Existing Flow Charts” on page 5-6.
- 3 Save the flow chart as a custom pattern in the Pattern Wizard. See “Save Custom Flow Chart Patterns” on page 5-9.
- 4 Reuse the custom pattern in a graphical function. See “Reuse Custom Flow Chart Patterns” on page 5-9.

Create Reusable Flow Charts

To create a flow chart, on the **Modeling** tab, select a pattern from the **Pattern** gallery. Pattern selections include:

- **If, If-Else, If-Elseif**, and other nested decision patterns.
- **For, While**, and **DoWhile** loop patterns.
- Switch patterns with up to four cases.
- Custom patterns that you saved for later reuse.
- Patterns that you define in a MATLAB `.m` file.

The Pattern dialog box prompts you for conditions and actions specific to the pattern that you select. For more information on flow chart patterns, see “MAB-Compliant Patterns from the Pattern Wizard” on page 5-11.

For example, to create the outer for loop in the upper triangle iterator pattern:

- 1 On the **Modeling** tab, select **Pattern > For Loop**.
- 2 In the Pattern dialog box, specify the initializer, loop test, and counting expressions for iterating through the first dimension of the matrix:

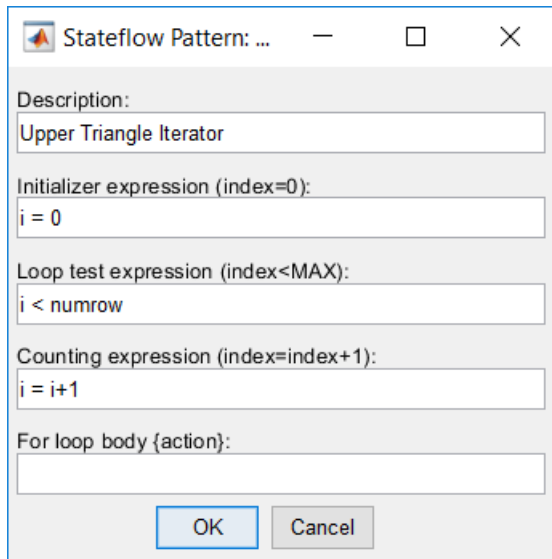

- 3 Click **OK**. The Pattern Wizard generates this flow chart.

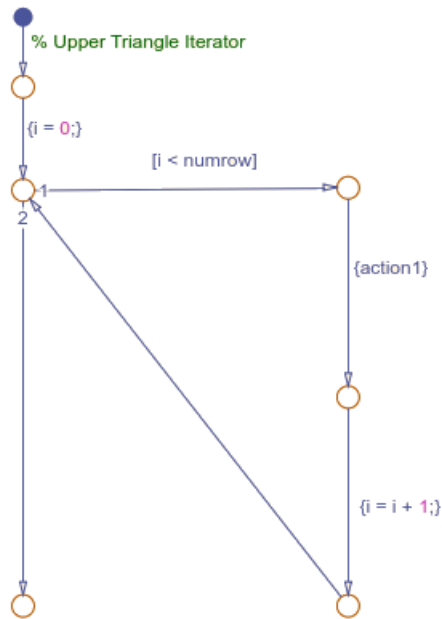

To complete the upper triangle iterator pattern, insert a second **for** loop along the vertical transition in this flow chart.

Insert Logic Patterns in Existing Flow Charts

Use the Pattern Wizard to add loop or decision logic extensions to an existing flow chart. Select an eligible vertical transition and choose a pattern from the **Pattern** gallery. Options include decision, loop, and switch patterns. The Pattern dialog box prompts you for conditions and actions specific to the pattern that you select.

For example, to add the second loop in the upper triangle iterator pattern:

- 1 In the Stateflow Editor, from the outer `for` loop pattern, select the vertical transition labeled `{action1}`.
- 2 On the **Modeling** tab, select **Pattern > For Loop**.
- 3 In the Pattern dialog box, specify the initializer, loop test, and counting expressions for iterating through the second dimension of the matrix. The initializer expression ensures that i never exceeds j . Also enter an action that retrieves each element in the upper triangle of the matrix.

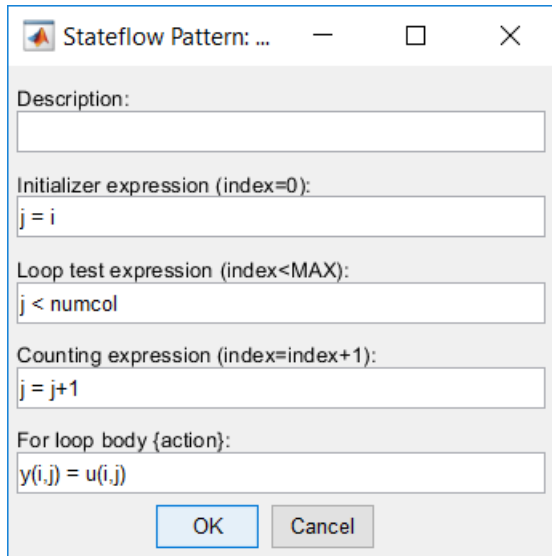

Stateflow Pattern: ...

Description:

Initializer expression (index=0):
j = i

Loop test expression (index<MAX):
j < numcol

Counting expression (index=index+1):
j = j+1

For loop body {action}:
y(i,j) = u(i,j)

OK Cancel

- 4 Click **OK**. The Pattern Wizard adds the second loop to the flow chart.

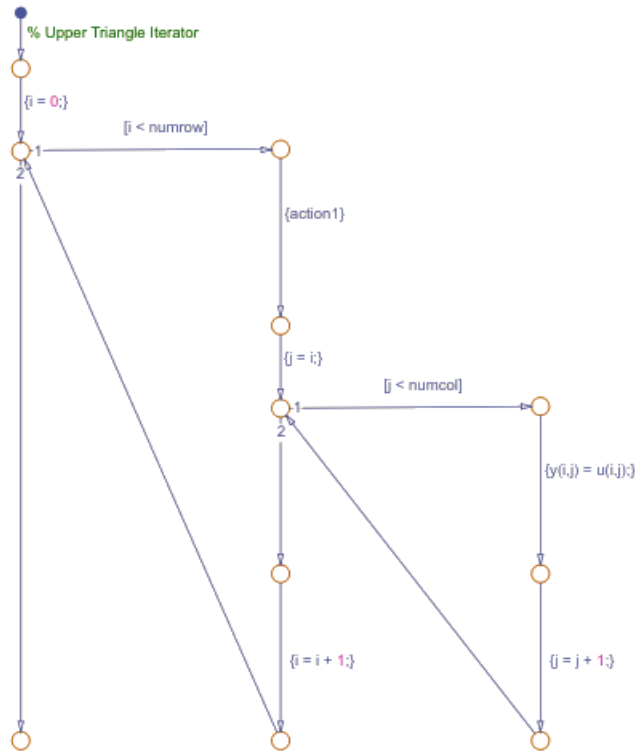

5 Save the model containing the pattern.

Guidelines for Inserting Logic Patterns

When you create logic extensions:

- You can select only one transition to extend at a time. The selected transition must be exactly vertical and have a destination junction.
- You can extend only flow charts created by the Pattern Wizard.
- The Stateflow chart containing the flow chart can contain only junctions and transitions. The chart cannot contain other objects, such as states, functions, or truth tables.
- You cannot extend a pattern that has been custom-created or modified.
- You cannot choose a custom pattern as the extension.

If your selection is not eligible for insertion, when you choose a pattern from the **Pattern** gallery, you see a message instead of pattern options.

Message	Issue
Select a vertical transition	You have not selected a vertical transition.
Selected transition must be exactly vertical	You selected a transition, but it is not vertical.
Select only one vertical transition	You have selected more than one transition.

Message	Issue
Editor must contain only transitions and junctions	There are other objects, such as states, functions, or truth tables, in the chart.

Save Custom Flow Chart Patterns

Use the Pattern Wizard to save flow chart patterns in a central location, and then easily retrieve them for reuse in graphical functions and charts. Select the flow chart with the pattern that you want to save and select **Pattern > Save As Pattern**.

For example, suppose that you want to save the upper triangle iterator pattern for later reuse:

- 1 Create a folder for storing your custom patterns. See “Guidelines for Creating a Custom Pattern Folder” on page 5-9.
- 2 In the Stateflow Editor, select the upper triangle iterator flow chart.
- 3 On the **Modeling** tab, select **Pattern > Save As Pattern**.
- 4 If you have not designated the custom pattern folder, the Pattern Wizard prompts you to select a folder. Choose the folder that you created and click **Select Folder**.
- 5 At the prompt, name your pattern `UpperTriangleIterator` and click **Save**. The Pattern Wizard saves your pattern as a model file `UpperTriangleIterator.slx` in the custom pattern folder.

Note You can use the Pattern Wizard to reuse only flow charts. To reuse states and subcharts, create an atomic subchart. For more information, see “Create Reusable Subcomponents by Using Atomic Subcharts” on page 16-2.

Guidelines for Creating a Custom Pattern Folder

The Pattern Wizard uses a single, flat folder for saving and retrieving flow chart patterns.

- Store all flow charts at the top level of the custom pattern folder. Do not create subfolders.
- Make sure that all flow chart files have an `.mdl` or `.slx` extension.

Change Your Custom Pattern Folder

The Pattern Wizard remembers your choice of custom pattern folder for future sessions. To choose a different folder, rename your existing custom pattern folder and do one of the following:

- Save a new custom pattern to the Pattern Wizard.
- Reuse an existing custom pattern from the Pattern Wizard.

The Pattern Wizard prompts you to choose a new folder.

Reuse Custom Flow Chart Patterns

The Pattern Wizard stores your flow charts as model files in the custom pattern folder. The patterns that you save in this folder appear in a drop-down list when you select **Pattern > Custom**. You can add a custom pattern directly to a chart or to a subcharted graphical function in your chart.

For example, to add the upper triangle iterator custom pattern to a graphical function:

- 1 From the object palette, add a graphical function to your chart as described in “Define a Graphical Function” on page 8-13.
- 2 Enter this function signature:

```
function y = ut_iterator(u, numrow, numcol)
```

The function takes three inputs.

Input	Description
<i>u</i>	2-D matrix
<i>numrow</i>	Number of rows in the matrix
<i>numcol</i>	Number of columns in the matrix

- 3 Right-click inside the function and select **Group & Subchart > Subchart**. The function appears as an opaque box.

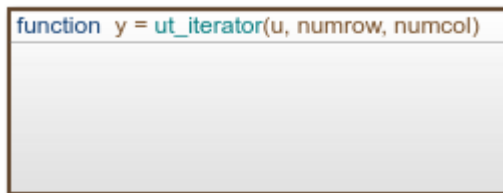

- 4 Double-click the subcharted function to open it.
- 5 Remove the default flow chart from the graphical function.
- 6 On the **Modeling** tab, select **Pattern > Custom**. A dialog box opens, listing all the patterns that you have saved in your custom pattern folder.

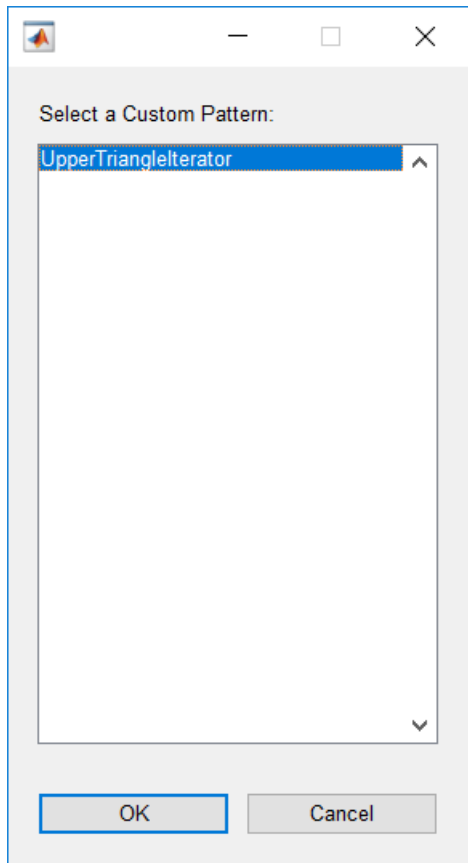

- 7 Select the upper triangle iterator pattern and click **OK**. The Pattern Wizard adds your custom pattern to the graphical function.
- 8 In the graphical function, in place of `action1`, substitute an appropriate action. This action repeats once for every row of the matrix.

MAB-Compliant Patterns from the Pattern Wizard

The Pattern Wizard generates flow charts whose geometry and layout comply with the guidelines from the MathWorks Automotive Advisory Board (MAB).

Decision Patterns

If

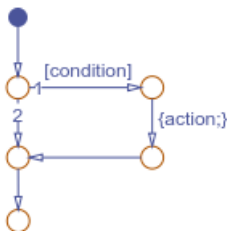

If-Else

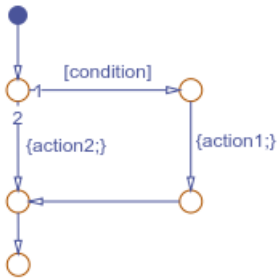

If-Elseif

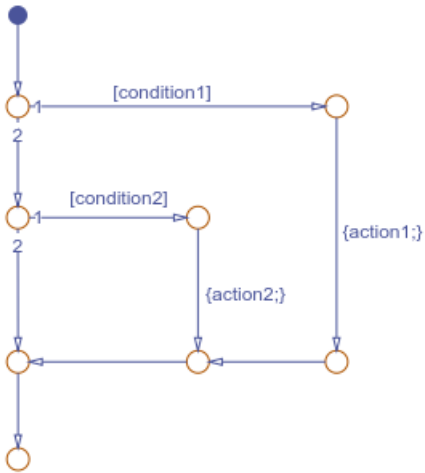

If-Elseif-Else

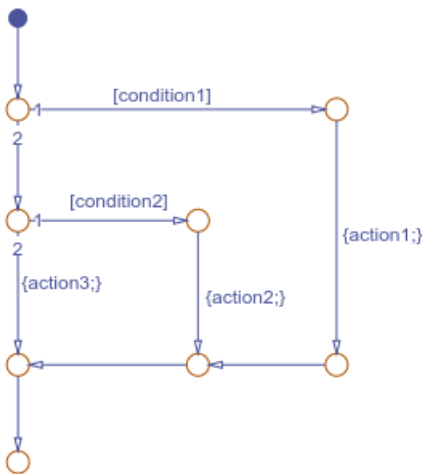

If-Elseif-Elseif-Else

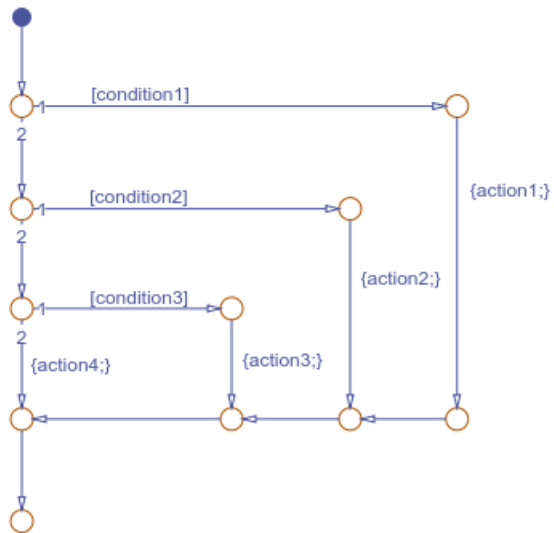

Nested If

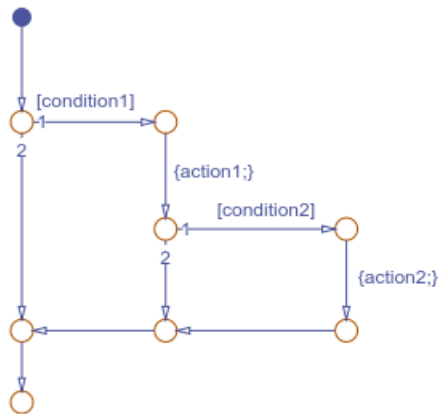

Loop Patterns

For Loop

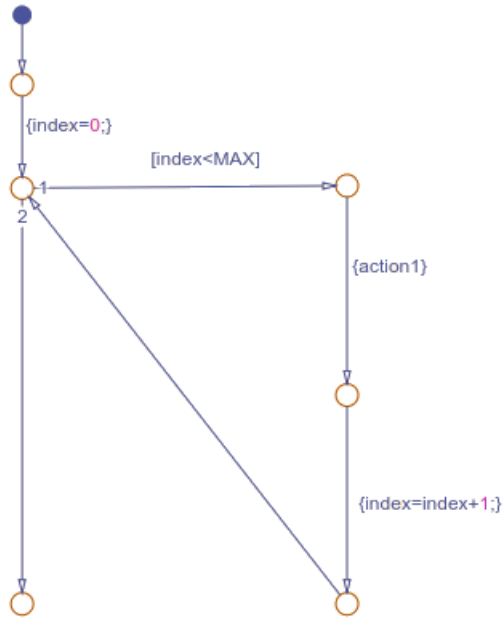

While Loop

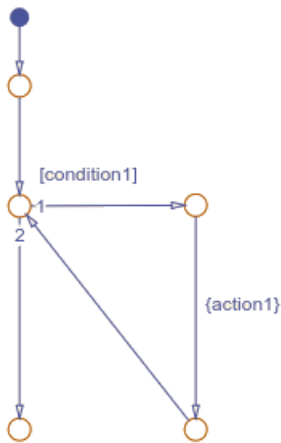

DoWhile Loop

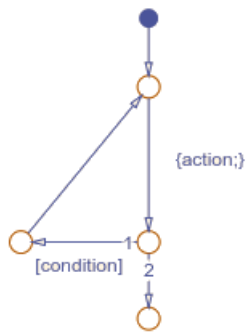

Switch Patterns

Two Cases

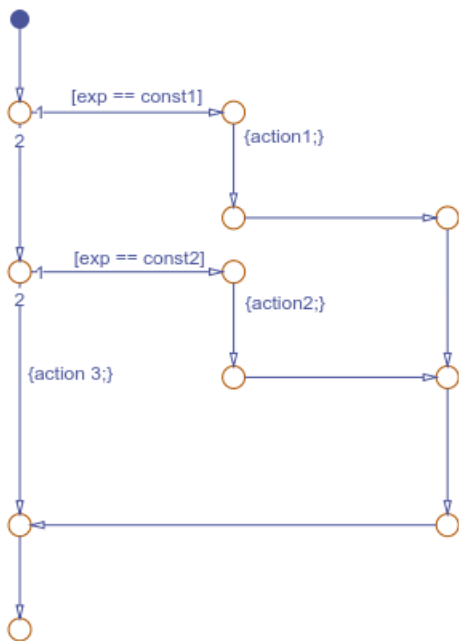

Three Cases

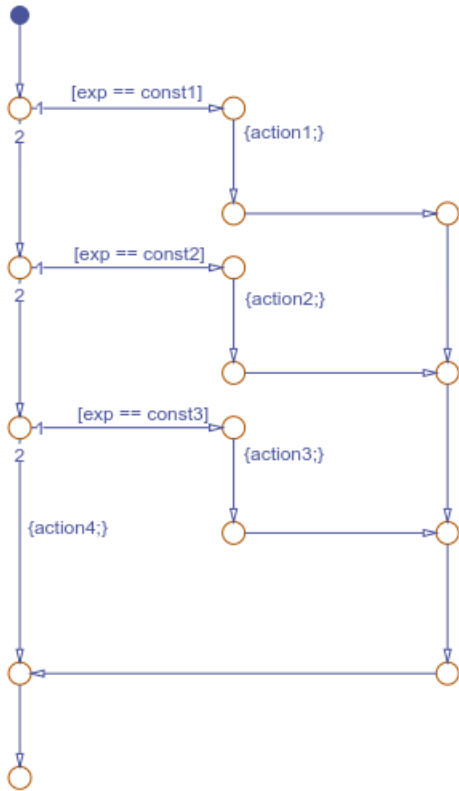

Four Cases

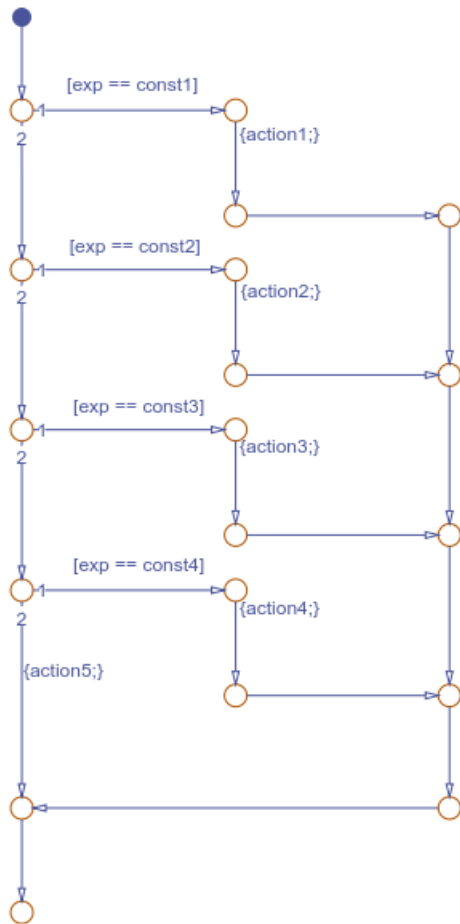

See Also

More About

- “Flow Charts in Stateflow” on page 5-2
- “Reuse Logic Patterns by Defining Graphical Functions” on page 8-13
- “Convert MATLAB Code into Stateflow Flow Charts” on page 5-18

Convert MATLAB Code into Stateflow Flow Charts

To transform your MATLAB code into Stateflow flow charts and graphical functions, use the Pattern Wizard. Supported patterns for conversion include:

- `if`, `if-else`, and other nested decision statements.
- `for` and `while` loops.
- `switch` statements.

The Pattern Wizard can convert MATLAB functions and scripts.

- MATLAB functions are converted to Stateflow graphical functions.
- MATLAB scripts are converted to Stateflow flow charts.

Converting MATLAB code is supported only in standalone Stateflow charts. For more information, see “Create Stateflow Charts for Execution as MATLAB Objects” on page 35-2.

Create Flow Charts from MATLAB Scripts

This MATLAB script empirically verifies one instance of the Collatz conjecture. When given the numeric input u , the script computes the hailstone sequence $n_0 = u, n_1, n_2, n_3, \dots$ by iterating this rule:

- If n_i is even, then $n_{i+1} = n_i/2$.
- If n_i is odd, then $n_{i+1} = 3n_i + 1$.

The Collatz conjecture states that every positive integer has a hailstone sequence that eventually reaches one.

```
% Hailstone sequence u, c(u), c(c(u)),...
y = [u];
while y(end) ~= 1
    y(end+1) = c(y(end));
end
disp(y);

function n = c(n)
% Compute next number in hailstone sequence.
% If n is even, then c(n) = n/2.
% If n is odd, then c(n) = 3*n+1.
    if rem(n,2) == 0
        n = n/2;
    else
        n = 3*n+1;
    end
end
```

The script executes a `while` loop that repeatedly calls the auxiliary function `c` until it produces an output value of one. The function `c` consists of a conditional `if-else` statement whose output depends on the parity of the input.

To convert this script into a flow chart and a graphical function:

- 1 Open a new standalone chart.

edit `hailstone.sfx`

- On the **State Chart** tab, select **Pattern > Select File**.
- In the dialog box, choose the MATLAB script and click **Open**. The Pattern Wizard adds a flow chart and a graphical function to your Stateflow chart. Double-click the graphical function to see its contents.

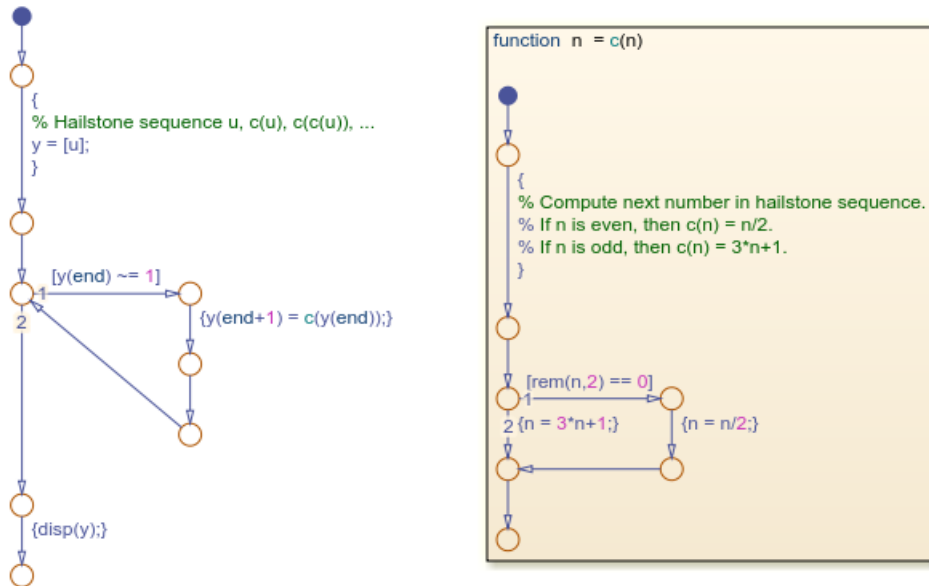

- In the Symbols pane, click **Resolve Undefined Symbols** . The Stateflow Editor resolves `u` and `y` as local data.

- Save your chart.

- To execute the chart from the Stateflow Editor, in the Symbols pane, enter a value of `u = 9` and

click **Run** . While the flow chart is executing, the Stateflow Editor highlights the active transitions through chart animation. When the execution stops, the MATLAB Command Window displays the hailstone sequence, starting with a value of nine:

9 28 14 7 22 11 34 17 52 26 13 40 20 10 5

- Click **Stop** .

You can copy generated flow charts and graphical functions and paste them in other charts, including Stateflow charts in Simulink models. If your MATLAB code uses functionality that is restricted for code generation in Simulink, you must modify the flow chart actions before simulating the chart. For more information, see “Call Extrinsic MATLAB Functions in Stateflow Charts” on page 31-26.

Note Suppose that you use `nargin` in a MATLAB function that you convert to a graphical function in a chart. Because `nargin` counts the chart object as one of the input arguments of the graphical function, the value of `nargin` in the graphical function is equal to one plus the value of `nargin` in the original MATLAB function. For more information, see “Execute a Standalone Chart” on page 35-2.

See Also

More About

- “Flow Charts in Stateflow” on page 5-2
- “Create Flow Charts by Using Pattern Wizard” on page 5-5
- “Reuse Logic Patterns by Defining Graphical Functions” on page 8-13
- “Create Stateflow Charts for Execution as MATLAB Objects” on page 35-2

Simulink Subsystems as Stateflow States

- “Simulink Subsystems as States” on page 6-2
- “Create and Edit Simulink Based States” on page 6-11
- “Access Block State Data” on page 6-17
- “Map Variables for Simulink Based States” on page 6-23
- “Set Simulink Based State Properties” on page 6-25

Simulink Subsystems as States

By using a Simulink subsystem within a Stateflow state, you can model hybrid dynamic systems or systems that switch between periodic or continuous time dynamics. In your Stateflow chart, you can use Simulink based states to model a periodic or continuous dynamic system combined with switching logic that uses transitions. You can access inputs and outputs from your chart within each Simulink based state. Simulink based states are supported only in Stateflow charts in a Simulink model.

To initialize Simulink blocks when switching between Simulink based states, use Stateflow textual notation or Simulink State Reader and State Writer blocks.

To create linked Simulink based states, use libraries to save action subsystems. When you copy an action subsystem from a library model into a Stateflow chart, it appears as a linked Simulink based state. When you update the library block, the changes are reflected in all Stateflow charts containing the block.

Using Simulink based states means that you do not have to use complex textual syntax in Stateflow to model hybrid systems.

When to Use Simulink Based States

Use Simulink based states when:

- You want to model hybrid dynamic systems that include continuous or periodic dynamics.
- The structure of the system dynamics change substantially between the various modes of operation, for example, modeling PID controllers.

For systems where you call logic intermittently, use Simulink functions.

When the structure of the Simulink algorithm remains substantially unchanged, but certain gains or parameters switch between various models, use Simulink logic outside of Stateflow. An example of this type of algorithm is gain scheduling. See “Model Gain-Scheduled Control Systems in Simulink” (Simulink Control Design).

Model a Pole Vaulter by Using Simulink Based States

This Stateflow chart models a person moving through the stages of pole vaulting by using Simulink based states. The first stage is the approach run of the vaulter, which is modeled in the Simulink based state `Run_up`. In the second stage, the vaulter plants the pole and takes off, which is modeled by the Simulink based state `Take_off`. The final stage happens when the vaulter clears the bar and releases the pole, which is modeled by the Simulink based state `Fly`.

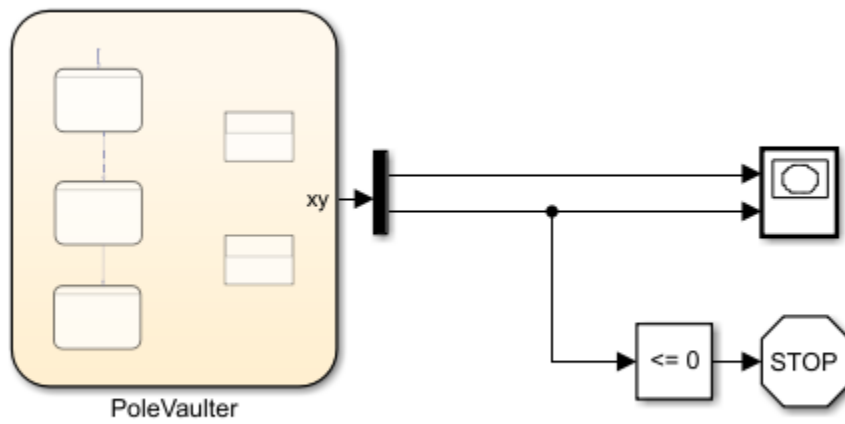

The Stateflow chart contains this logic:

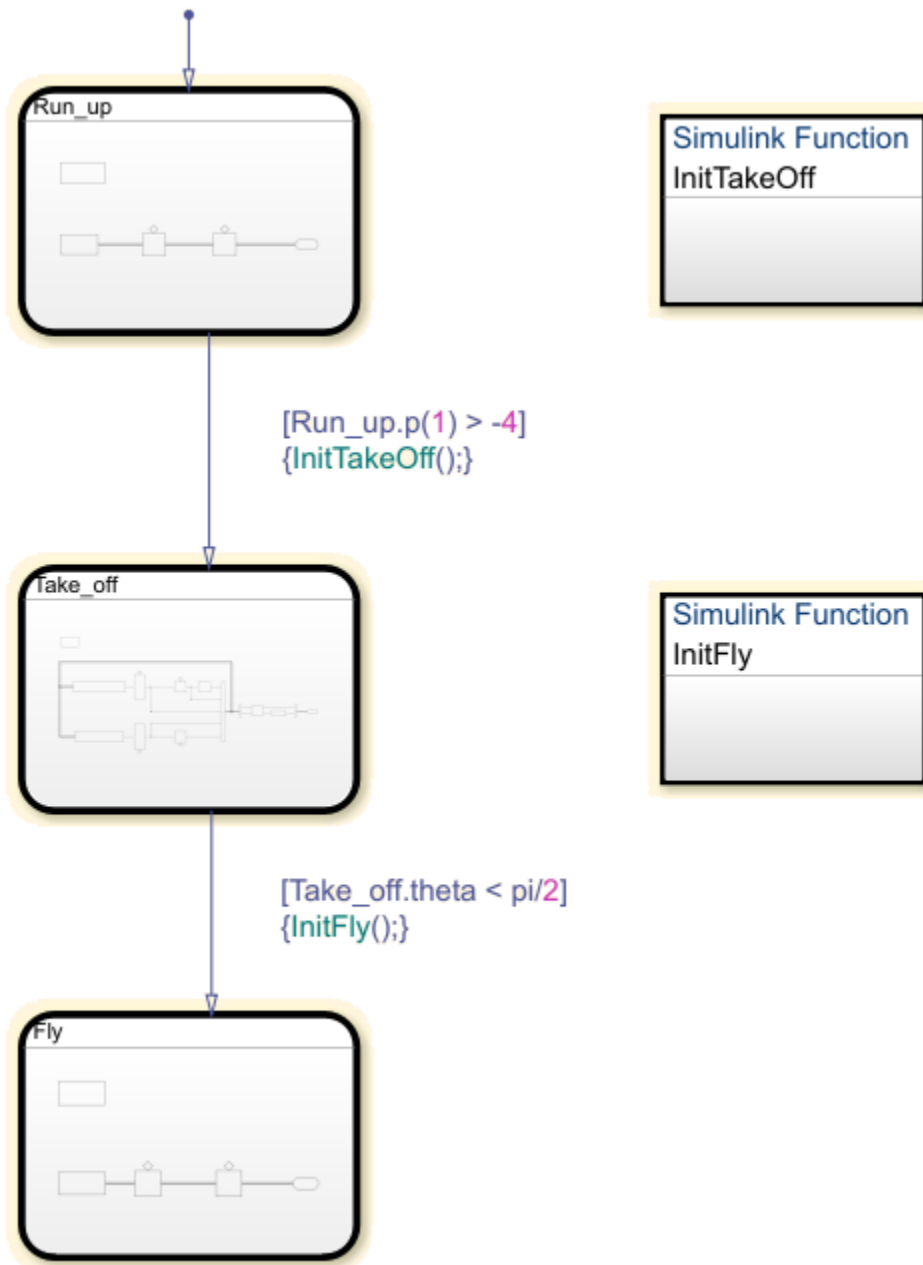

The states Run_up and Fly are easier to model by using Cartesian coordinates. The state Take_off is easier to model by using polar coordinates. To switch from one coordinate system to another, use Simulink functions InitTakeOff and InitFly.

Model the Approach of the Pole Vaulter

The Simulink based state Run_up contains this logic:

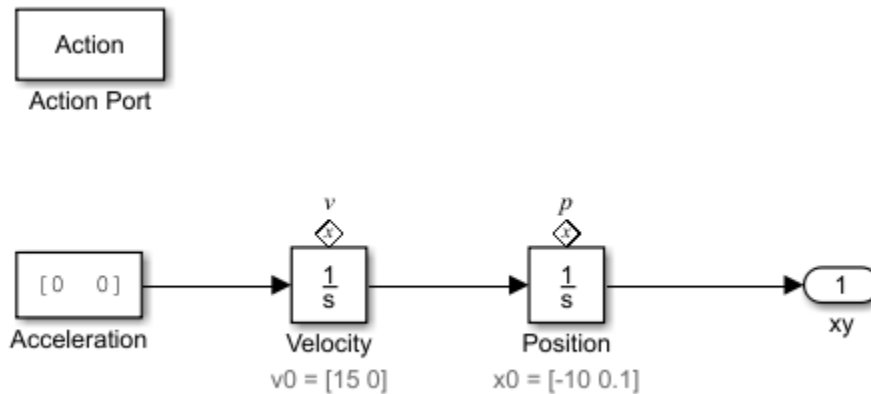

The default state in the chart PoleVault is Run_up. This state models the pole vaulter traveling along the ground toward the jump. The pole vaulter starts at -10 on the x-axis and runs toward zero. As the pole vaulter moves along the ground, the position of the pole vaulter in the xy-plane is continuously changing, but the state of running remains the same. In this model, the integrator blocks Position and Velocity are state owner blocks for State Reader blocks in the Simulink function InitTakeOff. This subsystem outputs the Cartesian coordinates of the pole vaulter.

Convert Cartesian Coordinates to Polar Coordinates

The Simulink function InitTakeOff contains this logic:

f()
f

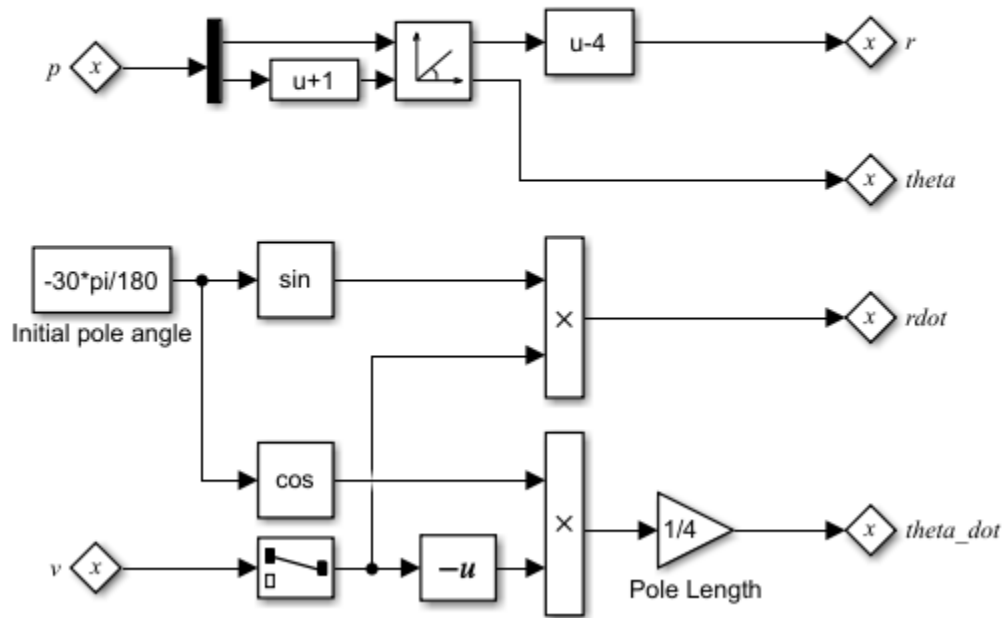

Once the position of the pole vaulter along the x-axis, $Run_up.p(1)$, becomes greater than -4, the transition from Run_up to $Take_off$ occurs. During the transition $InitTakeOff$ is initialized, the State Reader block connects to its owner block, and the function is executed. This function converts the Cartesian coordinates from Position and Velocity to polar coordinates, r , $theta$, $rdot$, and $theta_dot$. These coordinates are output as State Writer blocks, which are connected to owner blocks in the state $Take_off$.

Model the Take Off of the Pole Vaulter

The Simulink based state $Take_off$ contains this logic:

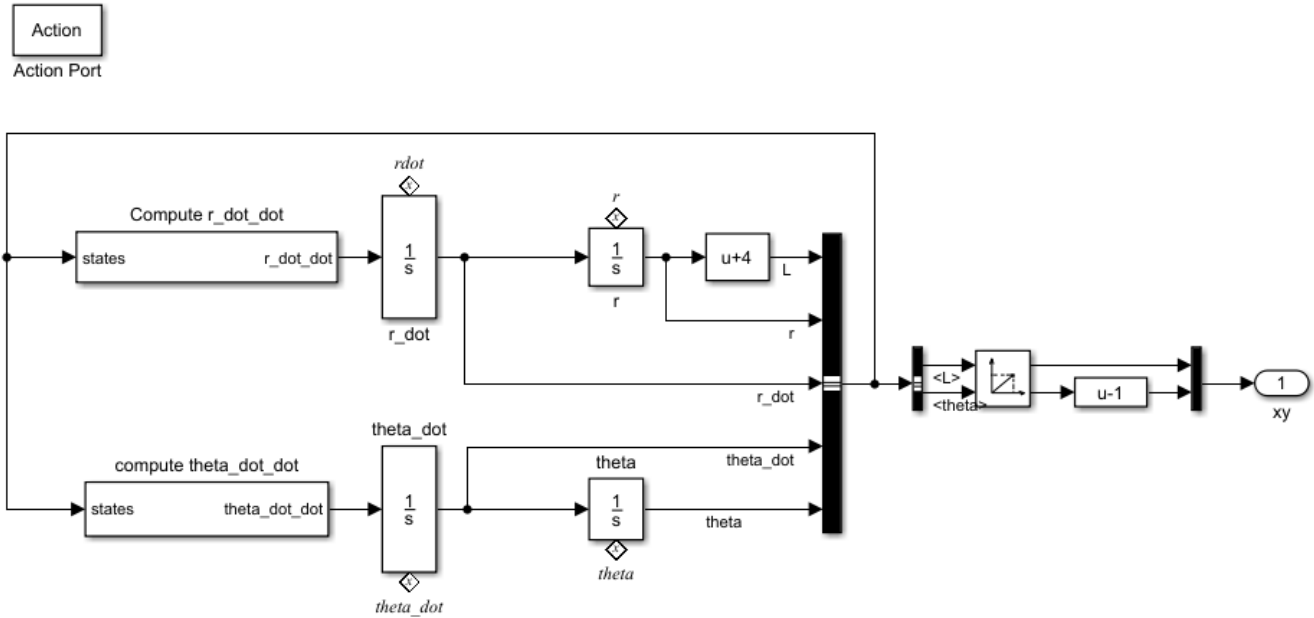

Once the position of the pole vaulter along the x-axis, $\text{Run_up.p}(1)$, becomes greater than -4, the active state becomes Take_off . This Simulink subsystem models the pole vaulter during the take off phase of the jump. The subsystem outputs the Cartesian coordinates of the pole vaulter.

Convert Polar Coordinates to Cartesian Coordinates

The Simulink function InitFly contains this logic:

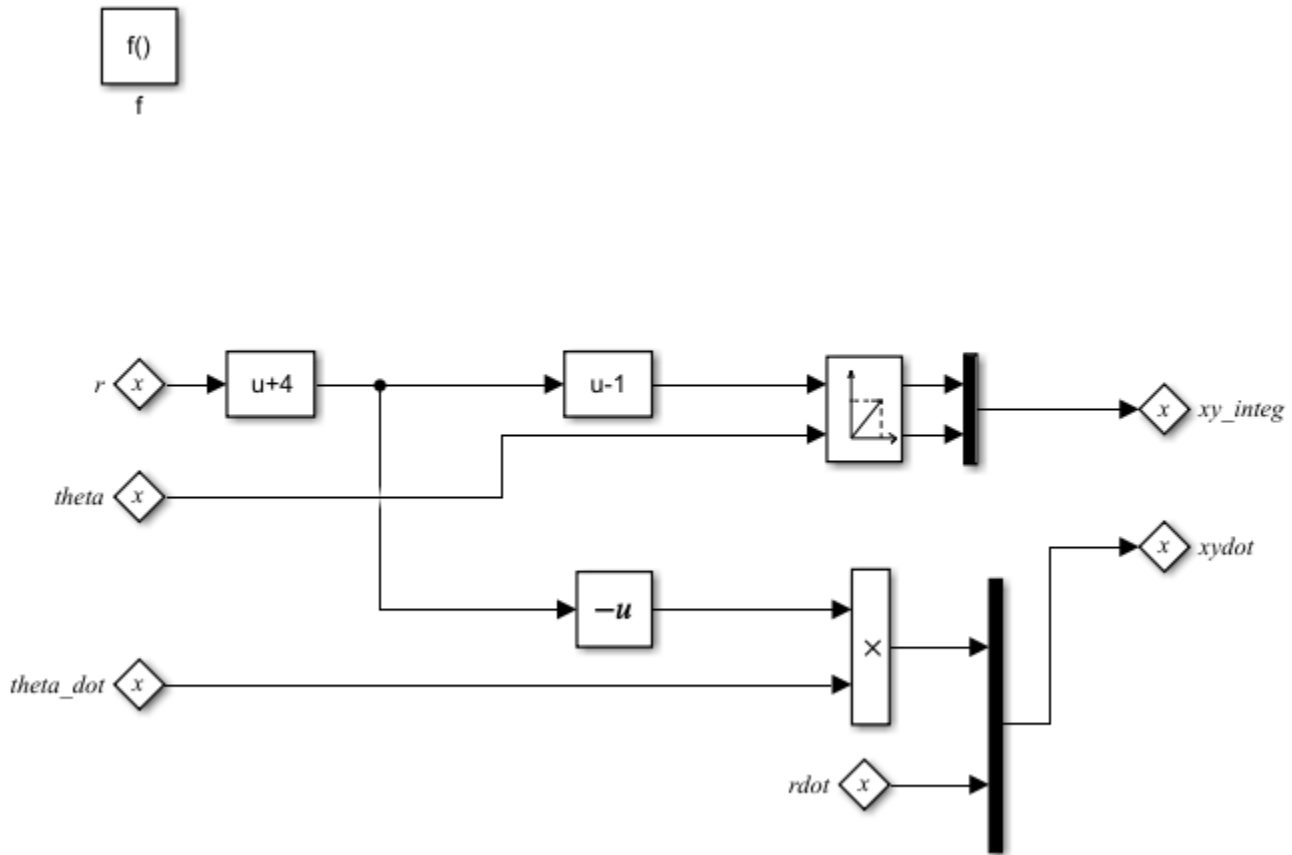

Once the angle of the pole vaulter, $theta$, becomes less than $\pi/2$, the transition from `Take_off` to `Fly` occurs. During the transition `InitFly` is initialized, the State Reader block connects to its owner block, and the function is executed. This function converts the polar coordinates from r , $theta$, and $theta_dot$ to Cartesian coordinates, xy_integ and $xydot$. These coordinates are output as State Writer blocks, which are connected to owner blocks in the state `Fly`.

Model the Free Fall of the Pole Vaulter

The Simulink based state `Fly` contains this logic:

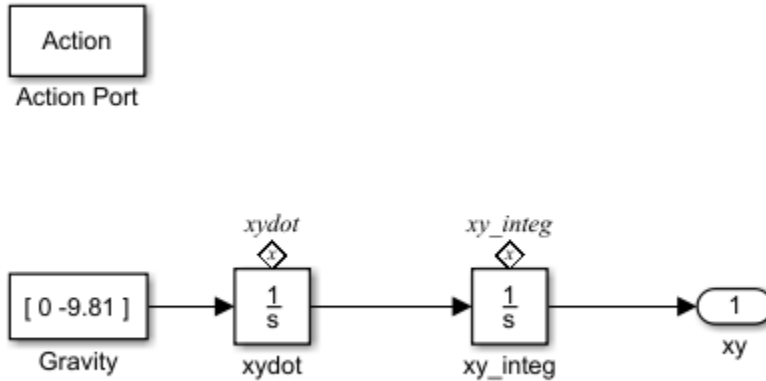

Once the angle of the pole vaulter, θ , is less than $\pi/2$, the active state becomes Fly. This state models the pole vaulter after the jump has cleared and the pole vaulter is falling to the ground. As the pole vaulter falls, the position of the pole vaulter in the x-y plane is continuously changing, but the state of falling remains the same. In this model, the integrator blocks `xydot` and `xy_integ` are state owner blocks for State Writer blocks in the Simulink function `InitFly`. This subsystem outputs the Cartesian coordinates of the pole vaulter.

The results of this simulation are seen in the XY Graph.

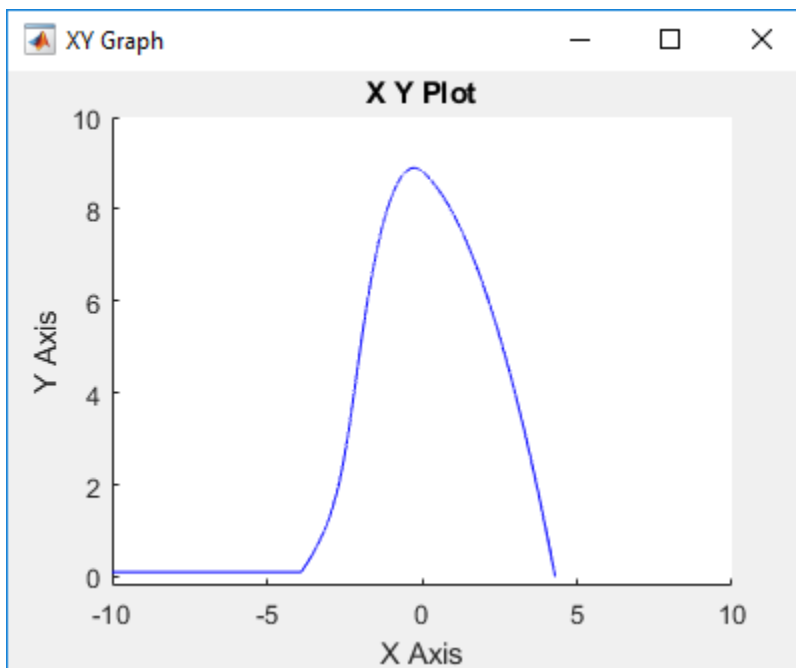

Limitations

You cannot use Simulink based states with:

- Moore charts

- Discrete Event charts
- HDL Coder
- PLC Coder
- Simulink Code Inspector
- Super step transitions

Simulink based states do not support debugging.

See Also

More About

- “Create and Edit Simulink Based States” on page 6-11
- “Reuse Charts in Models with Chart Libraries” on page 25-12
- “Create a Custom Library” (Simulink)

Create and Edit Simulink Based States

To model systems that switch between periodic or continuous time dynamics, use Simulink based states. Simulink based states are supported only in Stateflow charts in a Simulink model. For more information, see “Simulink Subsystems as States” on page 6-2.

You can create Simulink based state by using the drawing tool. To reuse systems from separate Simulink models, copy and paste enabled subsystems. To reuse subsystems in multiple Stateflow charts, copy and paste action subsystems that are saved in a library.

Create a Simulink Based State

To create a Simulink based state, do one of the following:

- Create an empty Simulink based state by using the Simulink based state drawing tool.
- Create a Simulink based state from another model by copying an enabled subsystem or an action subsystem to your Stateflow chart.
- Create a linked Simulink based state by copying an action subsystem from a library to your Stateflow chart.

Create an Empty Simulink Based State

- 1 Add a Stateflow chart block to a Simulink model. To open the Stateflow Editor, double-click the block.
- 2 On the object palette, click the Simulink based state drawing tool . Move your cursor onto your chart.
- 3 To place the new Simulink based state, click the Stateflow canvas. A shaded state appears.

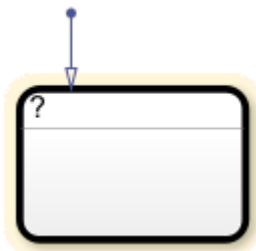

- 4 Enter the state label. In this example, the state models a pole vaulter running along a flat surface, so the state label is Run_up. Simulink based states are action subsystems, so an Action Port appears with your new state.



- Build your Simulink subsystem. This subsystem outputs the Cartesian coordinates of the pole vaulter. For more information about this model, see “Access Block State Data” on page 6-17.

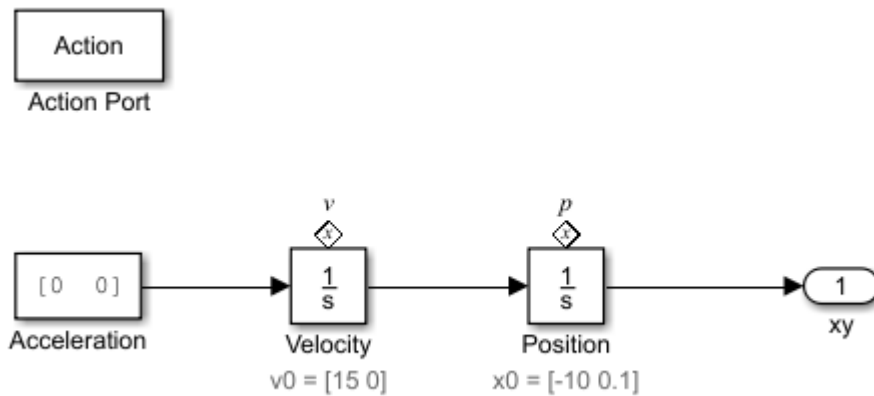

Create a Simulink Based State from an Enabled Subsystem

To create a Simulink based state in your Stateflow chart, copy enabled subsystems from separate Simulink models. You can reuse components from Simulink models in a Stateflow chart without creating a brand new Simulink based state.

- Open the sf_clutch_enabled_subsystems model.

Building a Clutch Lock-Up Model Using Stateflow(R) and Simulink(R)

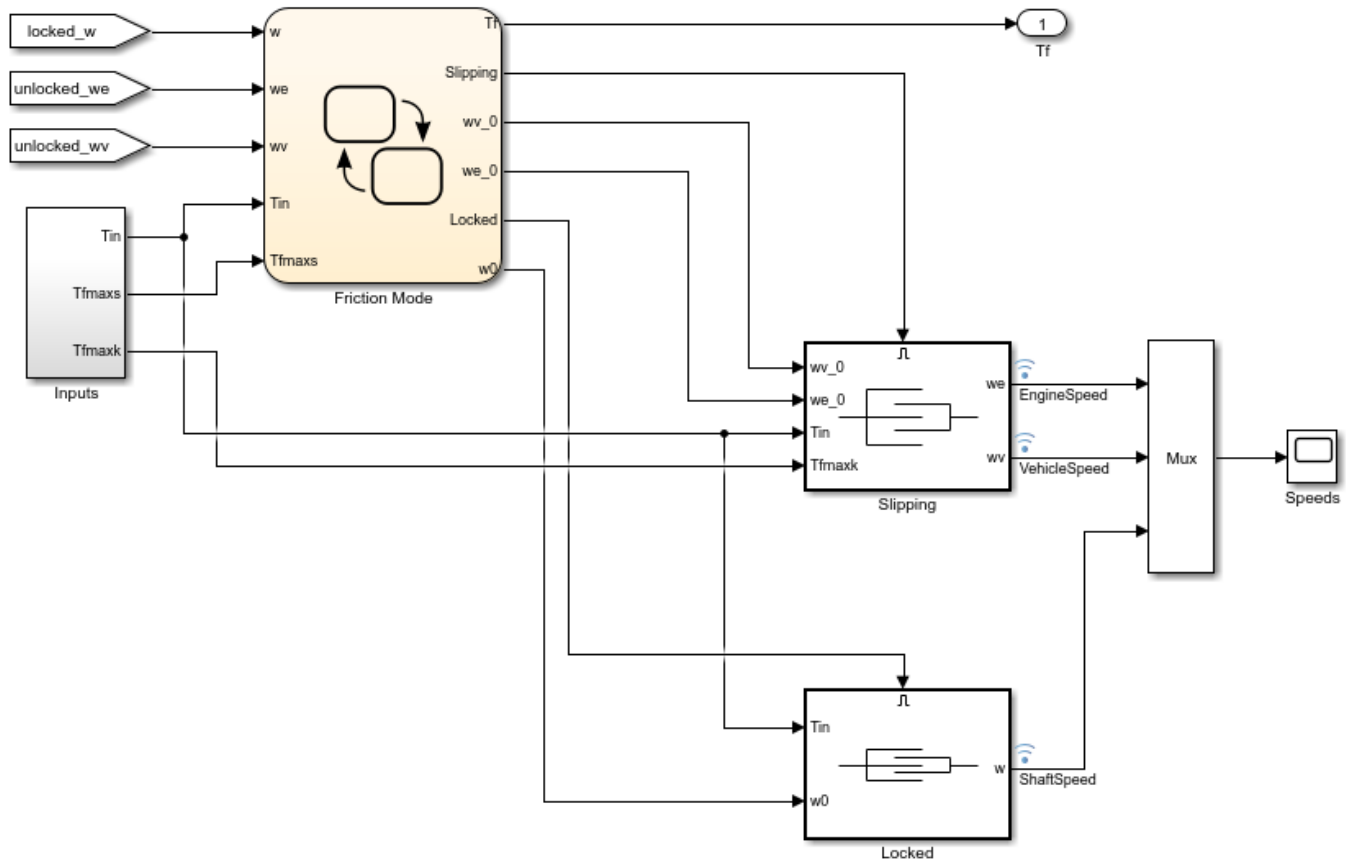

Copyright 2007-2012 The MathWorks, Inc.

- From the model, copy the block Slipping to your Stateflow chart.

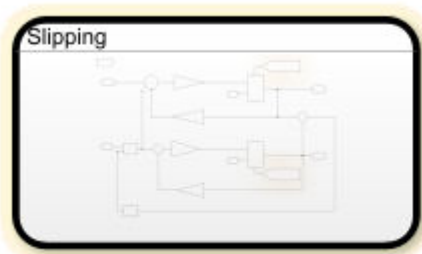

- The inports and outports of your Simulink subsystem appear as undefined symbols in your Stateflow chart. To add corresponding input and output data to your Stateflow chart, click the **Resolve undefined symbols** button .

Create a Linked Simulink Based State

To create a linked Simulink based state in your Stateflow chart, copy an action subsystem from a library to Stateflow. When the library block is updated, the changes are reflected in all Stateflow charts containing the block.

- 1 Open the library model.
- 2 Copy and paste the library block Run_up to your Stateflow chart.

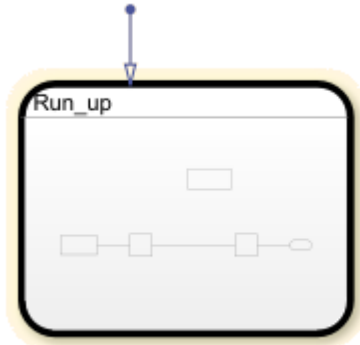

- 3 To display a link in the bottom leftmost corner on a linked subsystem, in the **Debug** tab, select **Information Overlays > Show All Links**.

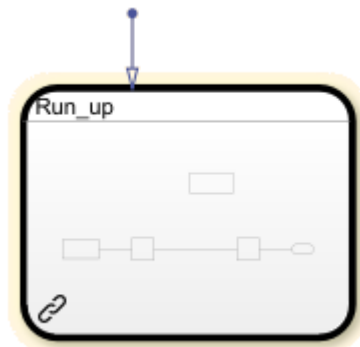

- 4 The outputs of this Simulink subsystem, xy, appears as an undefined symbol in your Stateflow chart. To add a corresponding output data to your Stateflow chart, click the **Resolve undefined symbols** button .

Create Inports and Outports

When using Simulink based states, inports and outports for your Simulink subsystem connect to input and output data at the Stateflow chart level. This connection allows the top-level Simulink model to read data from the subsystem contained within your Simulink based state.

When you create an empty Simulink based state, Stateflow creates inputs and outputs in your Simulink subsystem that correspond to inputs and outputs that exist in the parent Stateflow chart.

However, if you add inports and outputs to your Simulink based state after it is created, you must create corresponding input and output data for your Stateflow chart.

To create additional inports or outputs for a Simulink based state:

- 1 Open your Simulink based state.
- 2 Click the Simulink canvas, type `in1`, and press **Enter**. An undefined inport is created.
- 3 The undefined symbol `in1` appears in the Symbols pane of your Stateflow chart. To resolve the undefined symbol, click the **Resolve undefined symbols** button .
- 4 A chart inport named `In1` is created.

Create an Additional Output

In this example, you create an additional output for the model `sf_pole_vault`:

- 1 To open the model.
- 2 Open the chart `PoleVault` and double-click Simulink based state `Take_off`.
- 3 Click the Simulink based state canvas and type `out1` and press **Enter**. An undefined output is created. Rename the output `theta_out` and connect it to the signal for `theta`.

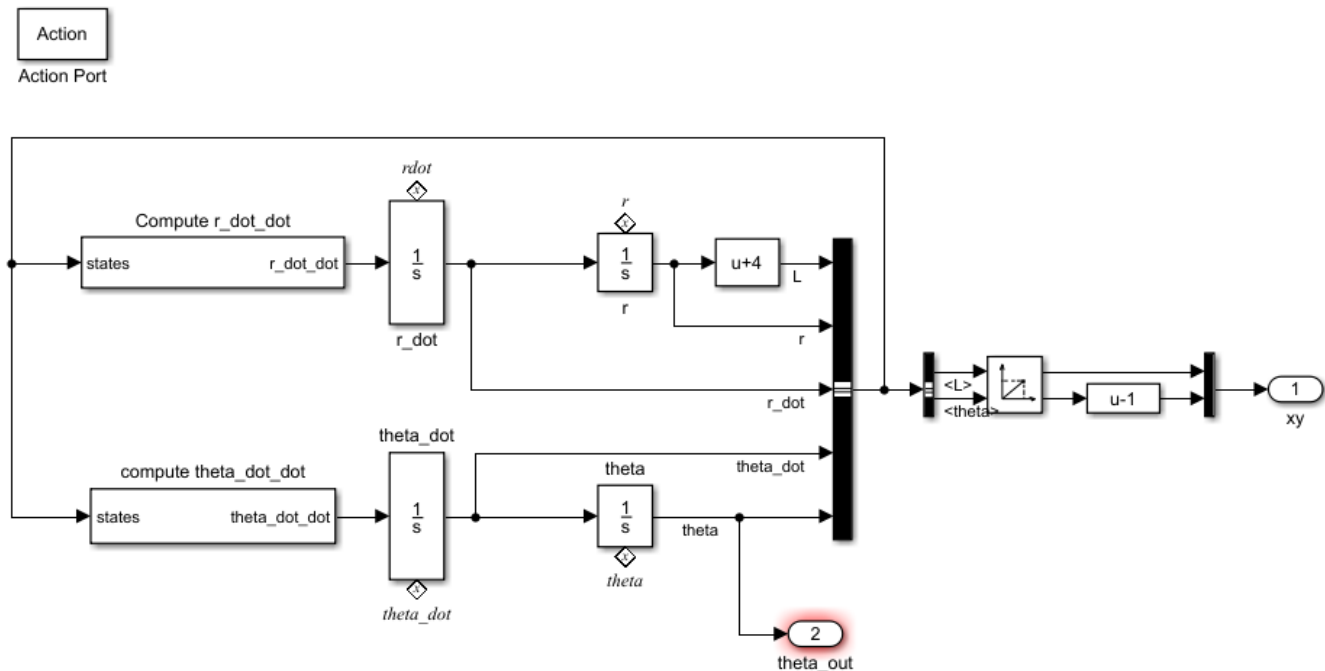

- 4 In the Symbols pane of `PoleVault`, an undefined symbol for `theta_out` appears. To resolve the undefined symbol, click the **Resolve undefined symbols** button .

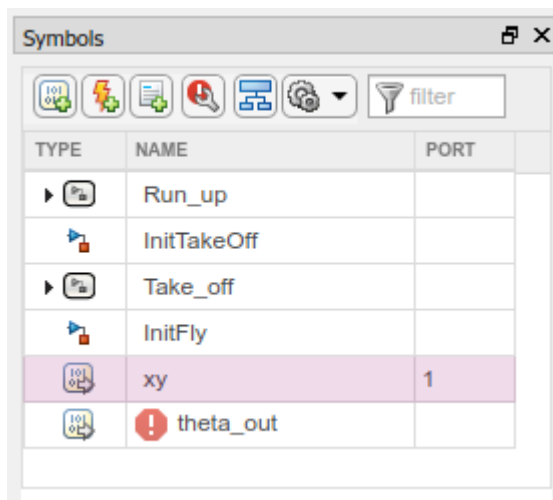

- 5 Stateflow creates an output in the chart called `theta_out` that corresponds to the output `theta_out`.

For more information about editing data, see “Add and Modify Data, Events, and Messages” on page 34-3.

See Also

More About

- “Simulink Subsystems as States” on page 6-2
- “Access Block State Data” on page 6-17
- “Map Variables in a Simulink Based State” on page 6-23
- “Reuse Charts in Models with Chart Libraries” on page 25-12
- “Create a Custom Library” (Simulink)

Access Block State Data

To model systems that switch between periodic or continuous time dynamics, use Simulink based states. Simulink based states are supported only in Stateflow charts in a Simulink model. For more information, see “Simulink Subsystems as States” on page 6-2.

You can read and write the state of blocks within your Simulink based states in transition actions of your Stateflow chart. You can read and write the state of blocks textually on the chart transitions or by using Simulink State Reader and State Writer blocks.

This Stateflow chart models a person moving through the stages of pole vaulting. The first stage is the approach run of the vaulter, which is modeled by the Simulink based state `Run_up`. In the second stage, the vaulter plants the pole and takes off, which is modeled by the Simulink based state `Take_off`. The final stage happens when the vaulter clears the bar and releases the pole, which is modeled by the Simulink based state `Fly`.

The states `Run_up` and `Fly` are easier to model by using Cartesian coordinates. The state `Take_off` is easier to model by using polar coordinates. The Simulink functions `InitTakeOff` and `InitFly` are used to switch from one coordinate system to another. For more details on this chart, see “Model a Pole Vaulter by Using Simulink Based States” on page 6-2.

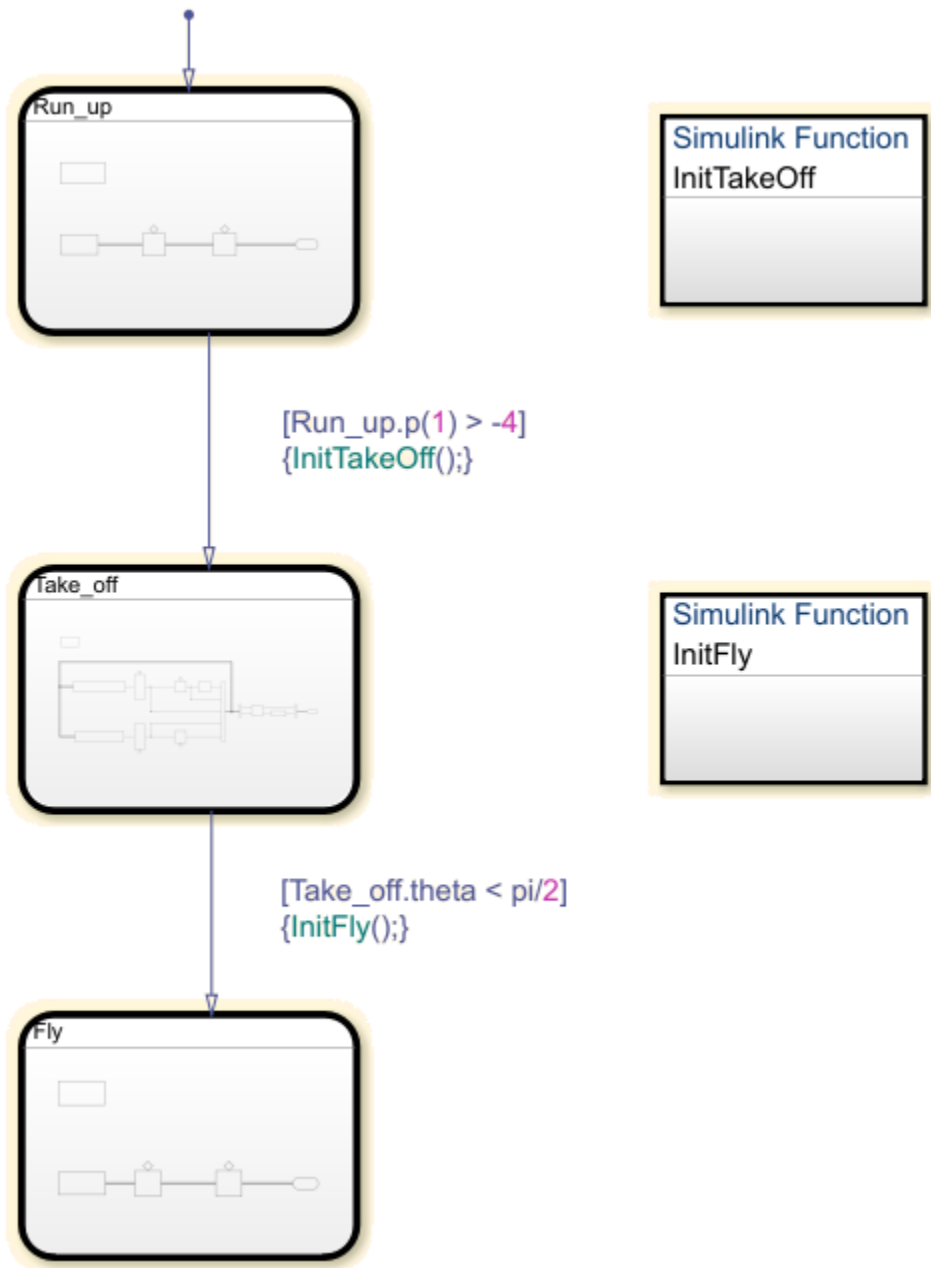

Textual Access

This subsystem is contained within the Simulink based state Run_up. For the transition from Run_up to Take_off to occur, the position of the pole vaulter along the x-axis, $p(1)$, must be greater than -4.

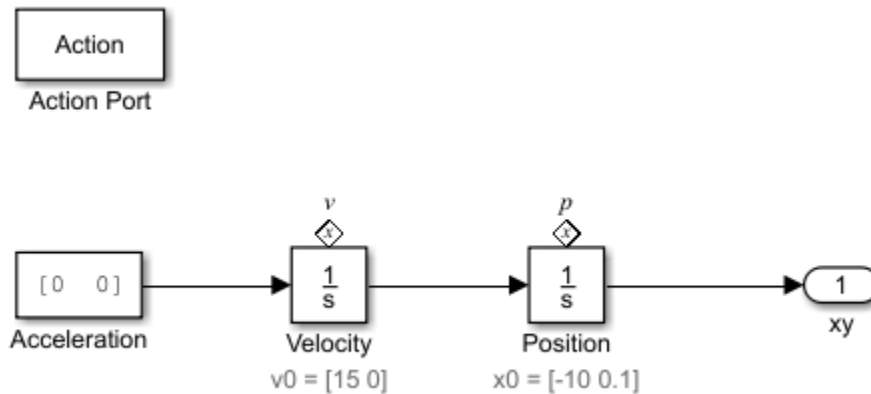

By setting the State Name of the integrator block **Position** to 'p', you can textually access the state of this block from your Stateflow chart. To access the state of the integrator block in the transition condition, type `[Run_up.p(1)> -4]`. When this condition becomes true, the transition is taken and the active state becomes `Take_off`.

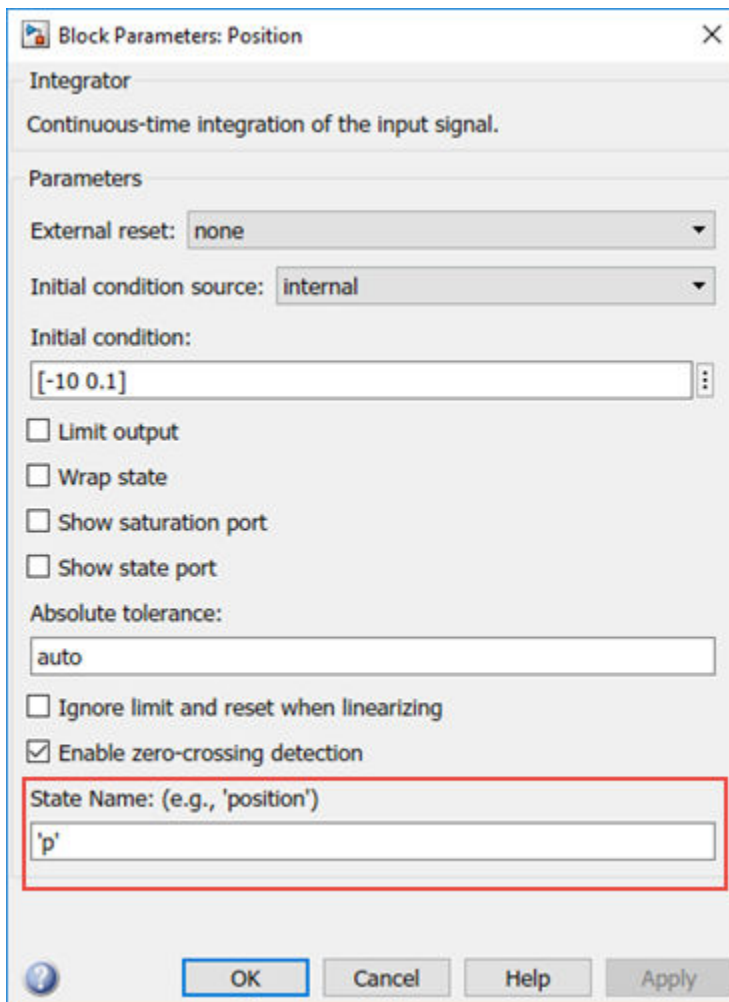

In the Symbols pane, you can see that the state 'p' appears under the state Run_up.

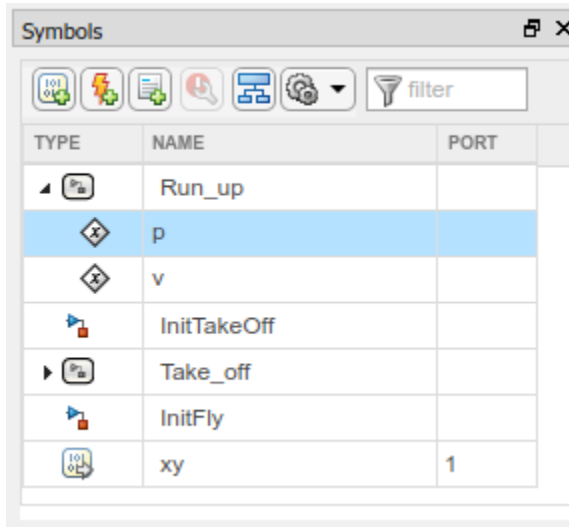

Graphical Access

Stateflow uses State Reader and State Writer blocks to connect the subsystems within a Simulink based state to other Simulink subsystems in your model. State Reader and State Writer blocks display the name of the state owner block that they are connected to. Conversely, the state owner block displays a tag  indicating a link to a State Reader or a State Writer block. If you click the label above the tag, a list opens with a link for navigating to the State Writer block.

Connect a State Reader Block to an Owner Block

The following subsystem is contained within the Simulink function `InitTakeOff`. The function uses State Reader blocks to connect to the state `Run_up` and reads `p` and `v`. The function then converts the Cartesian values for the position of the pole vaulter and velocity into polar coordinates, `r` and `theta` and `rdot` and `theta_dot`, respectively. These polar coordinates are then accessed by using state owner blocks in the state `Take_off`.

When the transition action occurs, the State Reader blocks in `InitTakeOff` read the state of their state owner blocks. Once the Simulink function finishes executing, the State Writer blocks write to the state owner blocks in the Simulink based state `Take_off`.

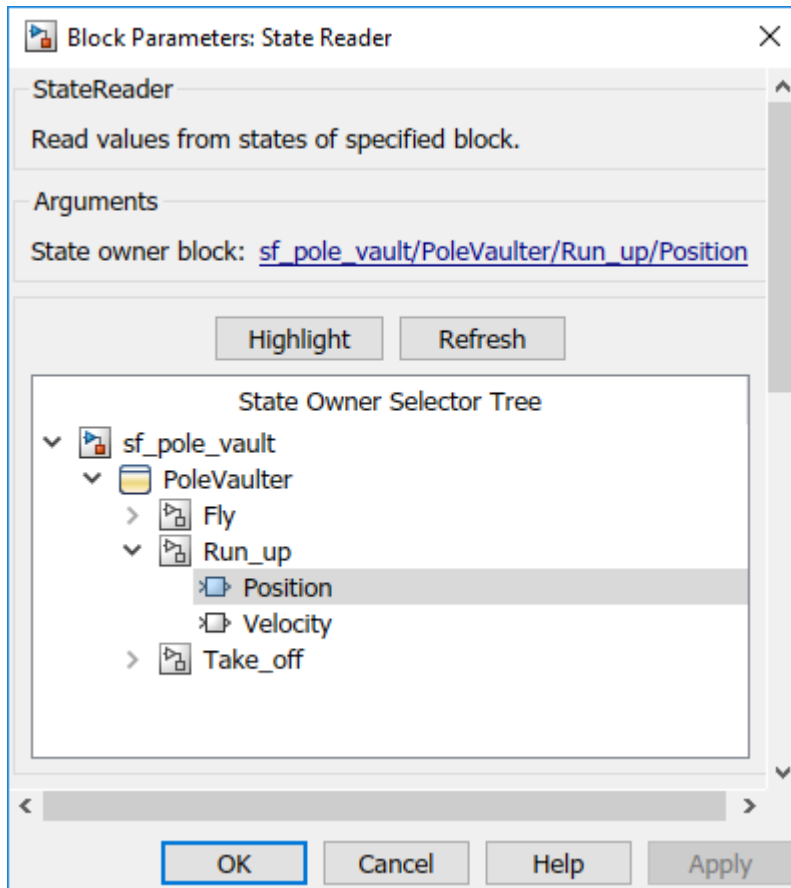

- 3 By connecting the State Reader block to the Position integrator block, this Simulink function can use the state of the integrator Position to execute.

See Also

More About

- “Simulink Subsystems as States” on page 6-2
- State Reader
- State Writer

Map Variables for Simulink Based States

To model systems that switch between periodic or continuous time dynamics, use Simulink based states. Simulink based states are supported only in Stateflow charts in a Simulink model. For more information, see “Simulink Subsystems as States” on page 6-2.

You can access inports or outports of a subsystem within a Simulink based state by using inputs and outputs in Stateflow that have the same name as your inports and outports. For Simulink based states that are created by copying and pasting enabled subsystems and action subsystems from a library, click the **Resolve undefined symbols** button to map your Simulink inports and outports to Stateflow inputs and outputs automatically. See “Create Inports and Outports” on page 6-14.

If you are using a linked Simulink based state where the name of the inport or outport differs from the Stateflow chart input or output, you must ensure that your variables are mapped correctly. You can change your mappings from the Property Inspector or in the Mappings dialog box.

Map Variables in a Simulink Based State

To open the mappings dialog box, select the Simulink Based State. In the **Simulink State** tab, click **Mappings**.

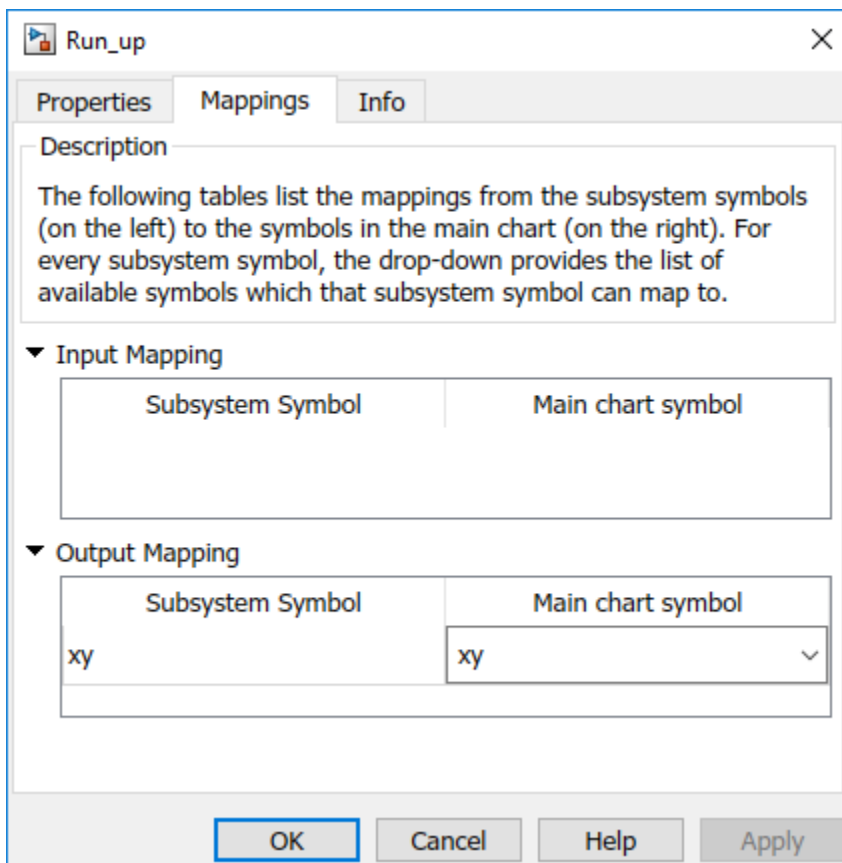

Under **Input Mapping**, you can specify which parent chart input maps to an inport in your Simulink subsystem.

Under **Output Mapping**, you can specify which parent chart output maps to an output in your Simulink subsystem.

See Also

More About

- “Simulink Subsystems as States” on page 6-2
- “Create and Edit Simulink Based States” on page 6-11
- “Access Block State Data” on page 6-17
- “Resolve Symbols Through the Symbols Pane” on page 31-24

Set Simulink Based State Properties

To model systems that switch between periodic or continuous time dynamics, use Simulink based states. Simulink based states are supported only in Stateflow charts in a Simulink model. For more information, see “Simulink Subsystems as States” on page 6-2.

Set and modify the properties of a Simulink based state in the Property Inspector or in a Simulink based state properties dialog box.

For a Simulink based state, you can set these properties.

Simulink Based State Properties	Description
Create data for monitoring self activity	Creates a data output port on the Stateflow block for this self-activity of the state.
Log self activity	Logs the state self-activity. View the activity of the state in the Simulation Data Inspector.
Logging name	Specify the signal logging name. To create a signal logging name that is different from the state name, choose Custom , and add the name.
Limit data points to last	Maximum number of data points to log. Default value is 5000, which means the chart logs the last 5000 data points generated by the simulation.
Decimation	Decimation interval limits the amount of data logged by skipping samples. Default value is 2, which means the chart logs every other sample.
Test point	Sets the Simulink based state as a Stateflow test point. See “Monitor Test Points in Stateflow Charts” on page 33-41.
Function packaging	Specify the code format generated for a Simulink based state. You can set the format to one of these options: <ul style="list-style-type: none"> • Auto — Simulink Coder software chooses the optimal format for you based on the type and number of instances of the subsystem that exist in the model. • Inline — Simulink Coder software inlines the subsystem unconditionally. • Nonreusable function — Simulink Coder software explicitly generates a separate function in a separate file. • Reusable function — Simulink Coder software generates a function with arguments that allows reuse of Simulink based state code when a model includes multiple instances of the Simulink based state. See “Function packaging” (Simulink).

See Also

More About

- “Rules for Naming Stateflow Objects” on page 2-5
- “Inspect and Modify Data and Messages While Debugging” on page 33-9
- “Specify Size of Stateflow Data” on page 9-33
- “Specify Type of Stateflow Data” on page 9-27

Build Mealy and Moore Charts

- “Overview of Mealy and Moore Machines” on page 7-2
- “Design Considerations for Mealy Charts” on page 7-5
- “Model a Vending Machine by Using Mealy Semantics” on page 7-7
- “Design Considerations for Moore Charts” on page 7-9
- “Model a Traffic Light by Using Moore Semantics” on page 7-12
- “Convert Charts Between Mealy and Moore Semantics” on page 7-14
- “Initialize Persistent Variables in MATLAB Functions” on page 7-18

Overview of Mealy and Moore Machines

In a finite state machine, *state* is a combination of local data and chart activity. "Computing state" means updating local data and making transitions from a currently active state to a new state. In state machine models, the next state is a function of the current state and its inputs:

$$X(n + 1) = f(X(n), u)$$

In this equation:

- $X(n)$ represents the state at time step n .
- $X(n+1)$ represents the state at the next time step $n+1$.
- u represents inputs.

State persists from one time step to the next time step.

Semantics of Mealy and Moore Machines

Mealy and Moore machines are often considered the basic, industry-standard paradigms for modeling finite-state machines. You can create charts that implement pure Mealy or Moore semantics as a subset of Stateflow chart semantics. You can use Mealy and Moore charts in simulation and code generation with Embedded Coder®, Simulink Coder, and HDL Coder™ software. Mealy and Moore semantics are supported only in Stateflow charts in Simulink models.

Semantics of Mealy Charts

Mealy machines are finite state machines in which transitions occur on clock edges. The output of a Mealy chart is a function of inputs and state:

$$y = g(X, u)$$

At every time step, a Mealy chart wakes up, evaluates its input, and then transitions to a new configuration of active states, also called its *next state*. The chart computes its output as it transitions to the next state.

To ensure that output is a function of input and state, Mealy state machines enforce these semantics:

- Outputs do not depend on the next state.
- The chart computes outputs only in transitions, not in states.
- The chart wakes up periodically based on a system clock.

Mealy machines compute their output on transitions. Therefore, Mealy charts can compute their first output at the time that the default path for the chart executes. If you enable the chart property **Execute (enter) Chart At Initialization** for a Mealy chart, this computation occurs at $t = 0$ (first time step). Otherwise, it occurs at $t = 1$ (next time step). For more information, see "Execute (Enter) Chart at Initialization" on page 25-5.

Semantics of Moore Charts

Moore machines are finite state machines in which output is modified at clock edges. The output of a Moore chart is a function only of state:

$$y = g(X)$$

At every time step, a Moore chart wakes up, computes its output, and then evaluates its input to reconfigure itself for the next time step. For example, after evaluating its input, the chart can transition to a new configuration of active states. The chart computes its output before evaluating its input and updating its state.

To ensure that output is a function only of the current state, Moore state machines enforce these semantics:

- Outputs do not depend on inputs.
- Outputs do not depend on previous outputs.
- Outputs do not depend on temporal logic.

Moore machines compute their output in states. Therefore, Moore machines can compute outputs only *after* the default path executes. Until then, outputs take the default values.

Create Mealy and Moore Charts

When you create a Stateflow chart, the default type is a hybrid state machine model called a *Classic* chart. Classic charts combine the semantics of Mealy and Moore charts with the extended Stateflow chart semantics.

To create a Mealy chart, at the MATLAB command prompt, enter:

```
sfnew -mealy
```



To create a Moore chart, at the MATLAB command prompt, enter:

```
sfnew -moore
```



Alternatively, after adding a Stateflow chart block to a Simulink model, you can choose the type of semantics for the chart by setting the **State Machine Type** chart property. For more information, see “State Machine Type” on page 25-2.

Advantages of Mealy and Moore Charts

Mealy and Moore charts offer these advantages over Classic Stateflow charts:

- You can verify that the Mealy and Moore charts you create conform to their formal definitions and semantic rules. Error messages appear at compile time (not at design time).
- Moore charts provide a more efficient implementation than Classic charts for C/C++ and HDL targets.
- You can use a Moore chart to model a feedback loop. In Moore charts, inputs do not have direct feedthrough. You can design a loop with feedback from the output port to the input port without

introducing an algebraic loop. Mealy and Classic charts have direct feedthrough and produce an error in the presence of an algebraic loop.

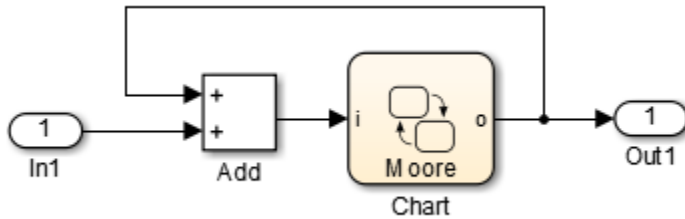

See Also

sfnew

More About

- “Design Considerations for Mealy Charts” on page 7-5
- “Design Considerations for Moore Charts” on page 7-9
- “Sequence Recognition by Using Mealy and Moore Charts”
- “Model a Vending Machine by Using Mealy Semantics” on page 7-7
- “Model a Traffic Light by Using Moore Semantics” on page 7-12
- “Convert Charts Between Mealy and Moore Semantics” on page 7-14

Design Considerations for Mealy Charts

Mealy machines are finite state machines in which transitions occur on clock edges. In Mealy charts, output is a function of input and state. At every time step, a Mealy chart wakes up, evaluates its input, and then transitions to a new configuration of active states, also called its *next state*. The chart computes its output as it transitions to the next state. Mealy semantics are supported only in Stateflow charts in Simulink models.

Mealy Semantics

To ensure that output is a function of input and state, Mealy state machines enforce these semantics:

- Outputs do not depend on the next state.
- The chart computes outputs only in transitions, not in states.
- The chart wakes up periodically based on a system clock.

Note A chart provides one time base for input and clock (see “Calculate Output and State by Using One Time Base” on page 7-6).

Design Rules for Mealy Charts

To conform to the Mealy definition of a state machine, ensure that every time there is a change on the input port, the chart computes outputs.

Compute Outputs in Condition Actions Only

You can compute outputs only in the condition actions of outer and inner transitions. A common modeling style for Mealy machines is to test inputs in conditions and compute outputs in the associated action.

Do Not Use State Actions or Transition Actions

You cannot use state actions or transition actions in Mealy charts. This restriction enforces Mealy semantics by:

- Preventing the chart from computing output without considering changes on the input port.
- Ensuring that output depends on the current state and not the next state.

Restrict Data Scope

In Mealy charts, these data restrictions apply:

- **Restrict Machine-Parented Data.** Machine-parented data is data that you define for a Stateflow machine. The Stateflow machine is the highest level of the Stateflow hierarchy. When you define data at this level, every chart in the machine can read and modify the data. To ensure that Mealy charts do not access data that can be modified unpredictably outside the chart, do not use machine-parented data.
- **Do Not Define Data Store Memory.** You cannot define data store memory (DSM) in Mealy charts because objects external to the chart can modify DSM. A Stateflow chart uses data store memory to share data with a Simulink model. Data store memory acts as global data. In the

Simulink hierarchy that contains the chart, other blocks and models can modify DSM. Mealy charts must not access data that can change unpredictably.

Restrict Use of Events

Limit the use of events in Mealy charts:

- **Valid Uses:**

- Use input events to trigger the chart.
- Use event-based temporal logic to guard transitions.

The change in value of a temporal logic condition behaves like an event that the Mealy chart schedules internally. At each time step, the number of ticks before the temporal event executes depends only on the state of the chart. For more information, see “Temporal Logic Operators” on page 13-40.

Note In Mealy charts, the base event for temporal logic operators must be a predefined event such as `tick` (see “Implicit Events Based on Data and States” on page 11-23).

- **Invalid Uses:**

- You cannot broadcast an event of any type.
- You cannot use local events to guard transitions. Local events violate Mealy semantics because they are not deterministic and can occur while the chart computes its outputs.
- You cannot use implicit events such as `chg(data_name)`, `en(state_name)`, or `ex(state_name)`.

Calculate Output and State by Using One Time Base

You can use one time base for clock and input, as determined by the Simulink solver. The Simulink solver sets the clock rate to be fast enough to capture input changes. As a result, a Mealy chart commonly computes outputs and changes states in the same time step. For more information, see “Compare Solvers” (Simulink).

See Also

More About

- “Overview of Mealy and Moore Machines” on page 7-2
- “Model a Vending Machine by Using Mealy Semantics” on page 7-7
- “Convert Charts Between Mealy and Moore Semantics” on page 7-14

Model a Vending Machine by Using Mealy Semantics

This example shows how to use Mealy semantics to model a vending machine.

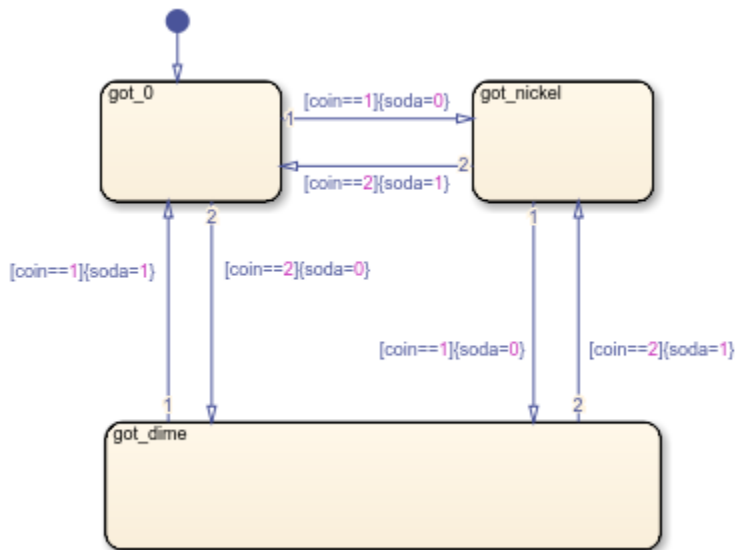

Logic of the Mealy Vending Machine

In this example, the vending machine requires 15 cents to release a can of soda. The purchaser can insert a nickel or a dime, one at a time, to purchase the soda. The chart behaves like a Mealy machine because its output `soda` depends on both the input `coin` and current state:

When initial state `got_0` is active. No coin has been received or no coins are left.

- If a nickel is received (`coin == 1`), output `soda` remains 0, but state `got_nickel` becomes active.
- If a dime is received (`coin == 2`), output `soda` remains 0, but state `got_dime` becomes active.
- If input `coin` is not a dime or a nickel, state `got_0` stays active and no soda is released (output `soda = 0`).

In active state `got_nickel`. A nickel was received.

- If another nickel is received (`coin == 1`), state `got_dime` becomes active, but no can is released (`soda` remains at 0).
- If a dime is received (`coin == 2`), a can is released (`soda = 1`), the coins are banked, and the active state becomes `got_0` because no coins are left.
- If input `coin` is not a dime or a nickel, state `got_nickel` stays active and no can is released (output `soda = 0`).

In active state `got_dime`. A dime was received.

- If a nickel is received (`coin == 1`), a can is released (`soda = 1`), the coins are banked, and the active state becomes `got_0` because no coins are left.
- If a dime is received (`coin == 2`), a can is released (`soda = 1`), 15 cents are banked, and the active state becomes `got_nickel` because a nickel (change) is left.

- If input `coin` is not a dime or a nickel, state `got_dime` stays active and no can is released (output `soda = 0`).

Design Rules in Mealy Vending Machine

This example of a Mealy vending machine illustrates these Mealy design rules:

- The chart computes outputs in condition actions.
- There are no state actions or transition actions.
- The chart defines chart inputs (`coin`) and outputs (`soda`).
- The value of the input `coin` determines the output: whether or not soda is released.

See Also

More About

- “Overview of Mealy and Moore Machines” on page 7-2
- “Design Considerations for Mealy Charts” on page 7-5
- “Convert Charts Between Mealy and Moore Semantics” on page 7-14

Design Considerations for Moore Charts

Moore machines are finite state machines in which output is modified at clock edges. In Moore charts, output is a function of the current state only. At every time step, a Moore chart wakes up, computes its output, and then evaluates its input to reconfigure itself for the next time step. For example, after evaluating its input, the chart can transition to a new configuration of active states. The chart computes its output before evaluating its input and updating its state. Moore semantics are supported only in Stateflow charts in Simulink models.

Moore Semantics

To ensure that output is a function *only* of the current state, Moore state machines enforce these semantics:

- Outputs do not depend on inputs.
- Outputs do not depend on previous outputs.
- Outputs do not depend on temporal logic.

Design Rules for Moore Charts

To conform to the Moore definition of a state machine, ensure that every time that a Moore chart wakes up, it computes outputs from the current set of active states without regard to inputs.

Restrictions on State Actions

To ensure that outputs depend solely on the current state, you can compute outputs in state actions, subject to these restrictions:

- **Combine Actions.** In Moore charts, you can include only one action per state. The action can consist of multiple command statements. Stateflow evaluates states in Moore charts from the top level down. Active states in Moore charts execute the state action before evaluating the transitions. Therefore, outputs are computed at each time step whether an outer transition is valid or not.
- **Do Not Label State Actions.** Do not label state actions in Moore charts with any keywords, such as `entry`, `during`, or `exit`. By default, Moore charts execute the actions in the active states before evaluating inputs and updating state.

Restrictions on Transition Actions

Transitions in Moore charts can contain condition and transition actions if these actions do not introduce a dependency between output values and input values. For example, in this chart, each transition tests the input `u` in a condition and modifies the output `y` in a condition action. Because the output value depends on the value of the input, this construct violates Moore semantics and triggers an error.

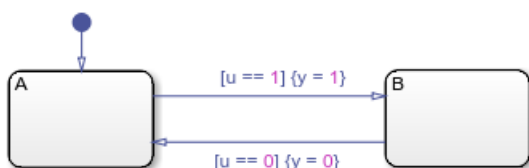

Do Not Use Inputs to Compute Outputs

In Moore charts, outputs cannot depend on inputs. Using an input to contribute directly or indirectly to the computation of an output triggers an error.

Restrict Data Scope

In Moore charts, these data restrictions apply:

- **Restrict Machine-Parented Data.** Machine-parented data is data that you define for a Stateflow machine. The Stateflow machine is the highest level of the Stateflow hierarchy. When you define data at this level, every chart in the machine can read and modify the data. To ensure that Moore charts do not access data that can be modified unpredictably outside the chart, do not use machine-parented data.
- **Do Not Define Data Store Memory.** You cannot define data store memory (DSM) in Moore charts because objects external to the chart can modify DSM objects. A Stateflow chart uses data store memory to share data with a Simulink model. Data store memory acts as global data. In the Simulink hierarchy that contains the chart, other blocks and models can modify DSM. Moore charts must not access data that can change unpredictably.

Do Not Use `coder.extrinsic` to Call Extrinsic Functions

When calling extrinsic functions with `coder.extrinsic`, it is not possible to enforce that the outputs depend only on the current state. Calling an extrinsic function with `coder.extrinsic` in a Moore chart triggers an error.

Do Not Use Simulink Functions

You cannot use Simulink functions in Moore charts. This restriction prevents violations of Moore semantics during chart execution.

Do Not Export Functions

You cannot export functions in a Moore chart.

Do Not Disable Inlining

Moore chart semantics require inlining.

Do Not Enable Super Step Semantics

You cannot use super step semantics in a Moore chart.

Do Not Use Messages

You cannot use messages in a Moore chart.

Restrict Use of Events

Limit the use of events in Moore charts:

- **Valid Uses:**
 - Use only one input event to trigger the chart.
 - Use event-based temporal logic to guard transitions.

The change in value of a temporal logic condition behaves like an event that the Moore chart schedules internally. At each time step, the number of ticks before the temporal event executes depends only on the state of the chart. For more information, see “Temporal Logic Operators” on page 13-40.

Note In Moore charts, the base event for temporal logic operators must be a predefined event such as `tick` (see “Implicit Events Based on Data and States” on page 11-23).

• **Invalid Uses:**

- You cannot broadcast an event of any type.
- You cannot use local events to guard transitions. Local events violate Moore semantics because they are not deterministic and can occur while the chart computes its outputs.
- You cannot use implicit events such as `chg(data_name)`, `en(state_name)`, or `ex(state_name)`.

Do Not Use Moore Charts for Modeling Continuous-Time Systems

In Moore charts, you cannot set the update method to `Continuous`. For modeling systems with continuous time in Stateflow, use `Classic` or `Mealy` charts.

See Also

More About

- “Overview of Mealy and Moore Machines” on page 7-2
- “Model a Traffic Light by Using Moore Semantics” on page 7-12
- “Convert Charts Between Mealy and Moore Semantics” on page 7-14

Model a Traffic Light by Using Moore Semantics

This example shows how to use Moore semantics to model a traffic light.

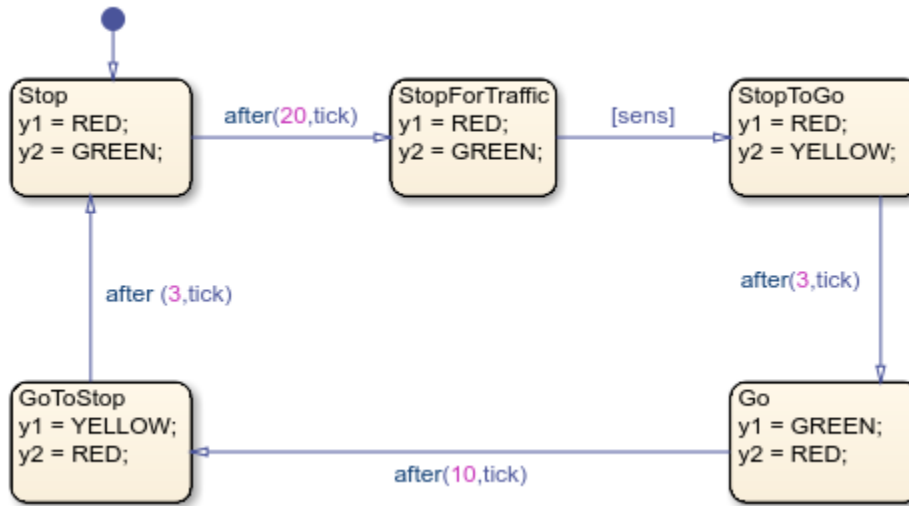

Logic of the Moore Traffic Light

In this example, the traffic light model contains a Moore chart called `Light_Controller`, which operates in five traffic states. Each state represents the color of the traffic light in two opposite directions, North-South and East-West, and the duration of the current color. The name of each state represents the operation of the light viewed from the North-South direction.

This chart uses temporal logic to regulate state transitions. The `after` operator implements a countdown timer, which initializes when the source state is entered. By default, the timer provides a longer green light in the East-West direction than in the North-South direction because the volume of traffic is greater on the East-West road. The green light in the East-West direction stays on for at least 20 clock ticks, but it can remain green as long as no traffic arrives in the North-South direction. A sensor detects whether cars are waiting at the red light in the North-South direction. If so, the light turns green in the North-South direction to keep traffic moving.

The `Light_Controller` chart behaves like a Moore machine because it updates its outputs based on current state before transitioning to a new state:

When initial state `Stop` is active. Traffic light is red for North-South, green for East-West.

- Sets output `y1 = RED` (North-South) based on current state.
- Sets output `y2 = GREEN` (East-West) based on current state.
- After 20 clock ticks, active state becomes `StopForTraffic`.

In active state `StopForTraffic`. Traffic light has been red for North-South, green for East-West for at least 20 clock ticks.

- Sets output `y1 = RED` (North-South) based on current state.
- Sets output `y2 = GREEN` (East-West) based on current state.
- Checks sensor.

- If sensor indicates cars are waiting (`[sens]` is true) in the North-South direction, active state becomes `StopToGo`.

In active state `StopToGo`. Traffic light must reverse traffic flow in response to sensor.

- Sets output `y1` = RED (North-South) based on current state.
- Sets output `y2` = YELLOW (East-West) based on current state.
- After 3 clock ticks, active state becomes `Go`.

In active state `Go`. Traffic light has been red for North-South, yellow for East-West for 3 clock ticks.

- Sets output `y1` = GREEN (North-South) based on current state.
- Sets output `y2` = RED (East-West) based on current state.
- After 10 clock ticks, active state becomes `GoToStop`.

In active state `GoToStop`. Traffic light has been green for North-South, red for East-West for 10 clock ticks.

- Sets output `y1` = YELLOW (North-South) based on current state.
- Sets output `y2` = RED (East-West) based on current state.
- After 3 clock ticks, active state becomes `Stop`.

Design Rules in Moore Traffic Light

This example of a Moore traffic light illustrates these Moore design rules:

- The chart computes outputs in state actions.
- The chart tests inputs in conditions on transitions.
- The chart uses temporal logic, but no asynchronous events.
- The chart defines chart inputs (`sens`) and outputs (`y1` and `y2`).

See Also

More About

- “Overview of Mealy and Moore Machines” on page 7-2
- “Design Considerations for Moore Charts” on page 7-9
- “Convert Charts Between Mealy and Moore Semantics” on page 7-14
- “Model An Intersection Of One-Way Streets” on page 10-20
- “Model a Distributed Traffic Control System by Using Messages” on page 12-29

Convert Charts Between Mealy and Moore Semantics

Mealy and Moore machines are often considered the basic, industry-standard paradigms for modeling finite-state machines. You can create charts that implement pure Mealy or Moore semantics as a subset of Stateflow chart semantics. Mealy and Moore semantics are supported only in Stateflow charts in Simulink models. For more information, see “Overview of Mealy and Moore Machines” on page 7-2.

A best practice is to not change from one Stateflow chart type to another in the middle of development. You cannot automatically convert the semantics of the original chart to conform to the design rules of the new chart type. Changing chart type usually requires you to redesign your chart to achieve the equivalent behavior of the original chart, so that both charts produce the same sequence of outputs given the same sequence of inputs. Sometimes, however, there is no way to translate specific behaviors without violating chart definitions.

This table lists a summary of what happens when you change chart types mid-design.

From	To	Result
Mealy	Classic	Mealy charts retain their semantics when changed to Classic type.
Classic	Mealy	If the Classic chart defines its output at every time step and conforms to Mealy semantic rules, the Mealy chart exhibits behavior equivalent to the original Classic chart.
Moore	Classic	State actions in the Moore chart behave as entry and during actions because they are not labeled. The Classic chart exhibits behavior that is not equivalent to the original Moore chart. Requires redesign.
Classic	Moore	Actions that are unlabeled in the Classic chart (entry and during actions by default) behave as during and exit actions. The Moore chart exhibits behavior that is not equivalent to the original Classic chart. Requires redesign.
Mealy	Moore	Mealy and Moore rules about placement of actions are mutually exclusive.
Moore	Mealy	Converting chart types between Mealy and Moore semantics does not produce equivalent behavior. Requires redesign.

Transform Chart from Mealy to Moore Semantics

This example shows how to use a Mealy chart to model a vending machine, as described in “Model a Vending Machine by Using Mealy Semantics” on page 7-7.

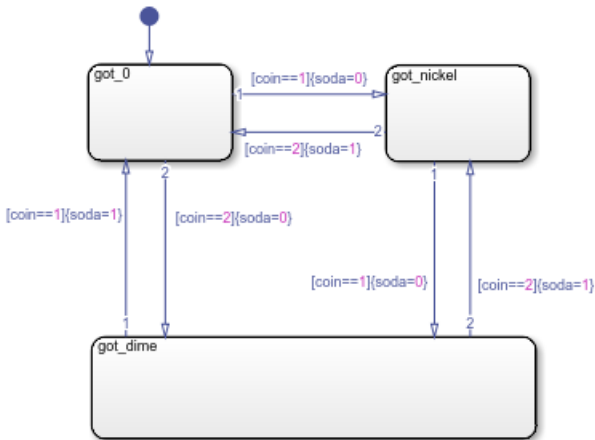

In the Mealy chart, each state represents one of the three possible coin inputs: nickel, dime, or no coin. Each condition action computes output (whether soda is released) based on input (the coin received) as the chart transitions to the next state. If you change the chart type to Moore, you get a compile-time diagnostic message indicating that the chart violates Moore chart semantics. According to Moore semantics, the chart output `soda` cannot depend on the value of the input `coin`.

To convert the chart to valid Moore semantics, redesign your chart by moving the logic that computes the output out of the transitions and into the states. In the Moore chart, each state must represent both coins received and the soda release condition (`soda = 0` or `soda = 1`). As a result, the redesigned chart requires more states.

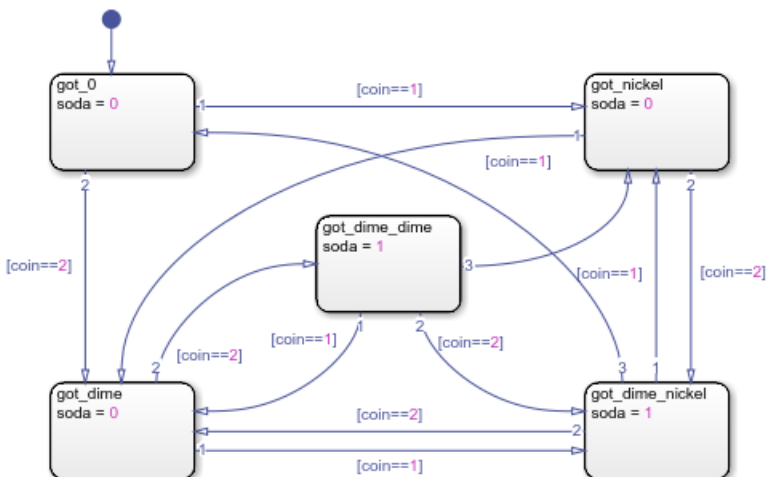

Before considering the value of `coin`, the Moore chart must compute the value of `soda` according to the active state. As a result, there is a delay in releasing soda, even if the machine receives enough money to cover the cost.

Compare Semantics of Vending Machines

This table compares the semantics of the charts before and after the transformation.

Mealy Vending Machine	Moore Vending Machine
Uses three states	Uses five states
Computes outputs in condition actions	Computes outputs in state actions
Updates output based on input	Updates output before evaluating input, requiring an extra time step to produce the soda

For this vending machine, Mealy is a better modeling paradigm because there is no delay in releasing the soda once sufficient coins are received. By contrast, the Moore vending machine requires an extra time step before producing the soda. Therefore, it is possible for the Moore vending machine to produce a can of soda at the same time step that it accepts a coin toward the next purchase. In this situation, the delivery of a soda can appear to be in response to this coin, but actually occurs because the vending machine received the purchase price in previous time steps.

Transform Chart from Moore to Mealy Semantics

This example shows how to use a Moore chart to model a traffic light, as described in “Model a Traffic Light by Using Moore Semantics” on page 7-12.

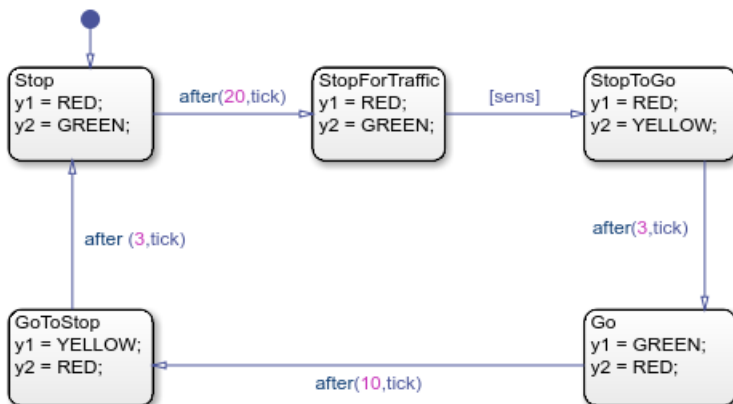

In the Moore chart, each state represents the colors of the traffic light in two opposite directions and the duration of the current color. Each state action computes output (the colors of the traffic light) regardless of input (if there are cars waiting at a sensor). If you change the chart type to Mealy, you get a compile-time diagnostic message indicating that the chart violates Mealy chart semantics. According to Mealy semantics, the chart cannot compute its outputs in state actions.

To convert the chart to valid Mealy semantics, redesign your chart by moving the logic that computes the output out of the states and into the transitions. The redesigned Mealy chart consists of five states, just like the Moore chart. In most transitions, a temporal logic expression or the Boolean input `sens` guards a condition action computing the outputs `y1` and `y2`. The only exceptions are:

- The default transition, which computes the initial outputs without a guarding condition.
- The transition from the `Stop` state to the `StopForTraffic` state, which does not compute new outputs.

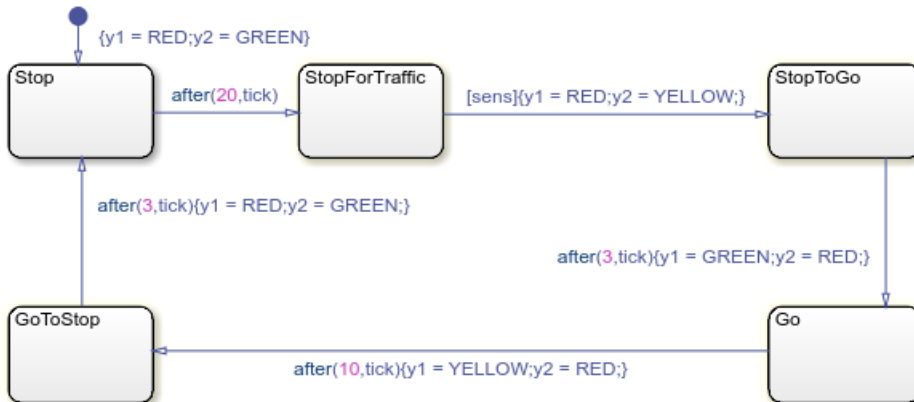

In the same time step, the Mealy chart evaluates the temporal logic expressions and the input signal `sens`, and computes the value of the outputs `y1` and `y2`. As a result, in the Mealy chart, the output changes one time step before the corresponding change occurs in the original Moore chart. In the Simulink model, you can compensate for the anticipated changes in output by adding a Delay block to each output signal.

Compare Semantics of Traffic Light Controllers

This table compares the semantics of the charts before and after the transformation.

Moore Traffic Light Controller	Mealy Traffic Light Controller
Uses five states	Uses five states
Computes outputs in state actions	Computes outputs in condition actions
Updates output before evaluating input	Updates output based on input, requiring a Delay block in each output signal

See Also

More About

- “Overview of Mealy and Moore Machines” on page 7-2
- “Design Considerations for Mealy Charts” on page 7-5
- “Design Considerations for Moore Charts” on page 7-9
- “Model a Vending Machine by Using Mealy Semantics” on page 7-7
- “Model a Traffic Light by Using Moore Semantics” on page 7-12

Initialize Persistent Variables in MATLAB Functions

A persistent variable is a local variable in a MATLAB function that retains its value in memory between calls to the function. For code generation, functions must initialize a persistent variable if it is empty. For more information, see `persistent`.

When programming MATLAB functions in these situations:

- MATLAB Function blocks with no direct feedthrough
- MATLAB Function blocks in models that contain State Control blocks in Synchronous mode
- MATLAB functions in Stateflow charts that implement Moore machine semantics

The specialized semantics impact how a function initializes its persistent data. Because the initialization must be independent of the input to the function, follow these guidelines:

- The function initializes its persistent variables only by accessing constants.
- The control flow of the function does not depend on whether the initialization occurs.

For example, this function has a persistent variable `n`.

```
function y = fcn(u)
    persistent n

    if isempty(n)
        n = u;
        y = 1;
        return
    end

    y = n;
    n = n + u;
end
```

This type of initialization results in an error because the initial value of `n` depends on the input `u` and the `return` statement interrupts the normal control flow of the function.

To correct the error, initialize the persistent variable by setting it to a constant value and remove the `return` statement. For example, this function initializes the persistent variable without producing an error.

```
function y = fcn(u)
    persistent n

    if isempty(n)
        n = 1;
    end

    y = n;
    n = n + u;
end
```

MATLAB Function Block With No Direct Feedthrough

This model contains a MATLAB function block that defines the function `fcn`, described previously. The input `u` is a square wave with values of 1 and -1.

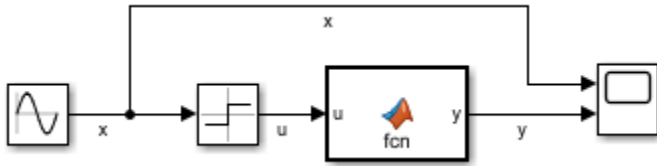

In the MATLAB function block:

- The initial value of the persistent variable n depends on the input u .
- The return statement interrupts the normal control flow of the function.

Because the **Allow direct feedthrough** check box is cleared, the initialization results in an error.

If you modify the function so it initializes n independently of the input, then you can simulate an error-free model.

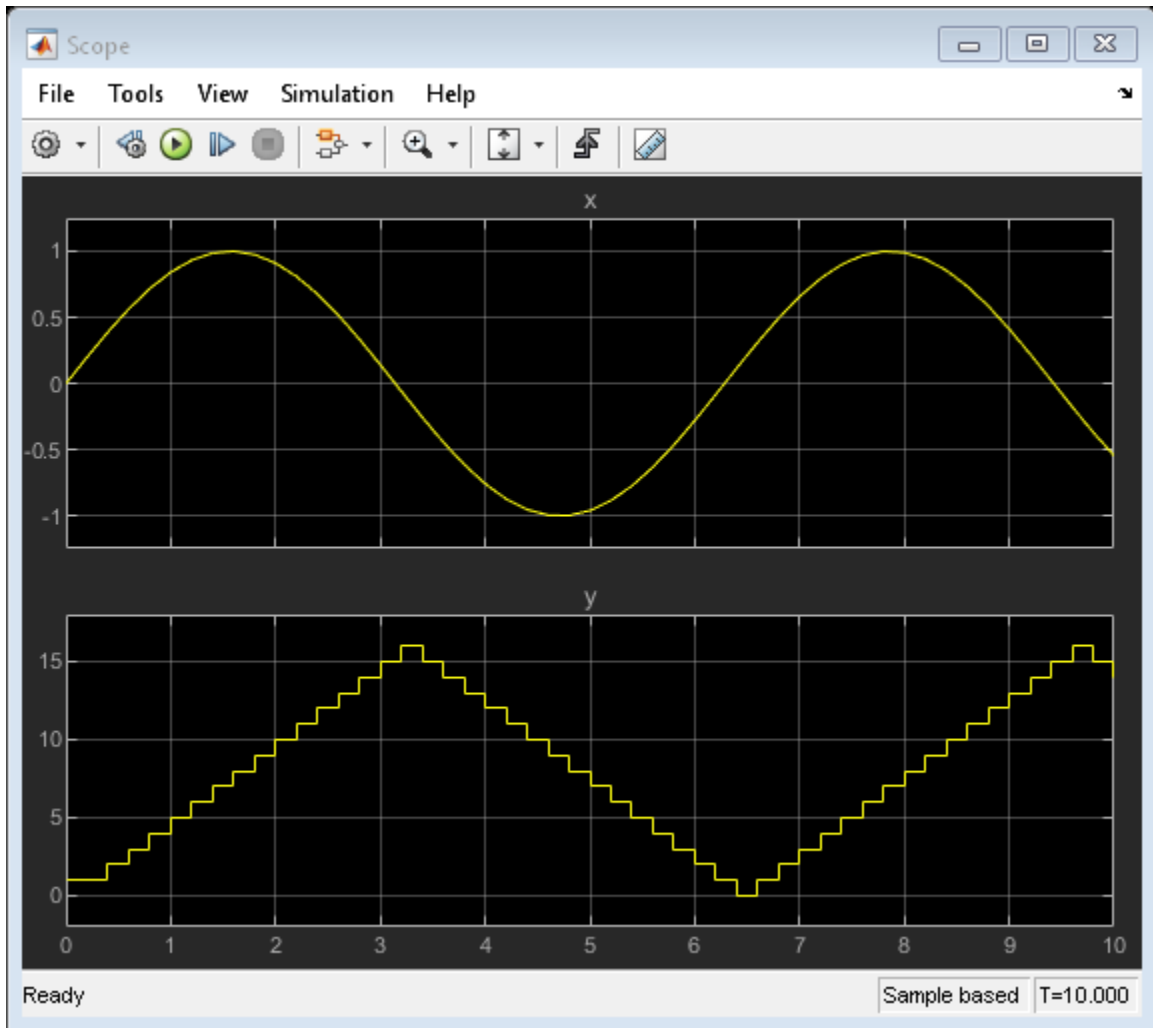

State Control Block in Synchronous Mode

This model contains a MATLAB function block that defines the function `fcn`, described previously. The input `u` is a square wave with values of 1 and -1.

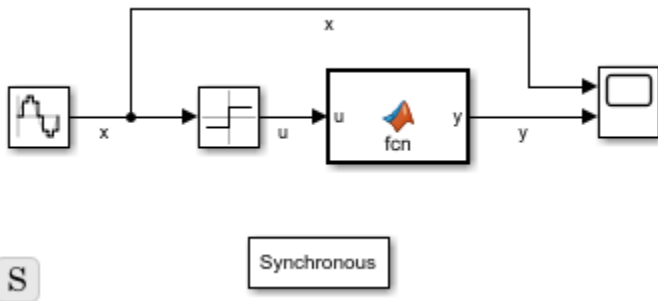

In the MATLAB function block:

- The initial value of the persistent variable n depends on the input u .
- The return statement interrupts the normal control flow of the function.

Because the model contains a State Control block in Synchronous mode, the initialization results in an error.

If you modify the function so it initializes n independently of the input, then you can simulate an error-free model.

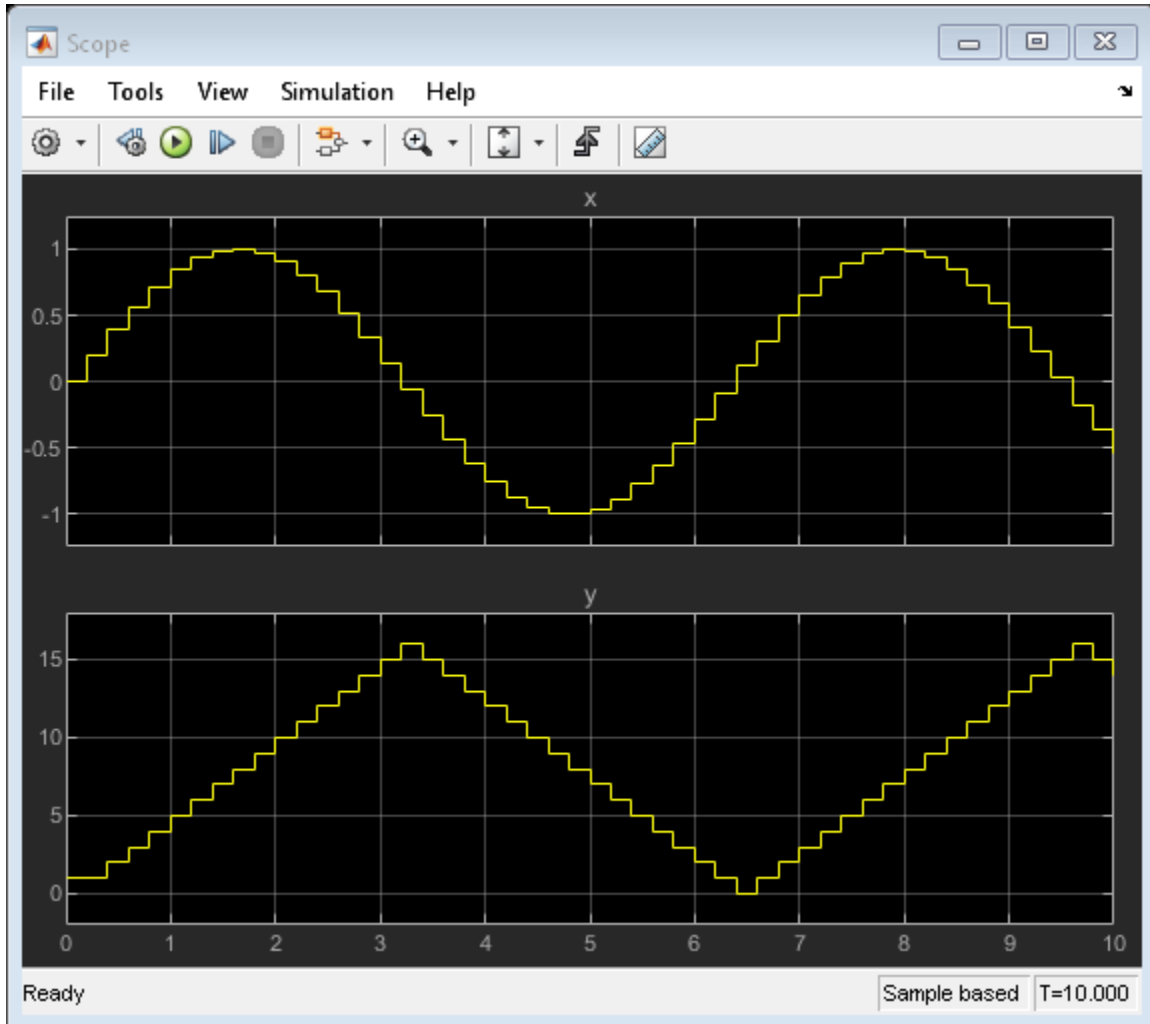

Stateflow Chart Implementing Moore Semantics

This model contains a Stateflow chart that implements Moore machine semantics. The chart contains a MATLAB function that defines the function `fcn`, described previously. The input u has values of 1 and -1 that depend on the state of the chart.

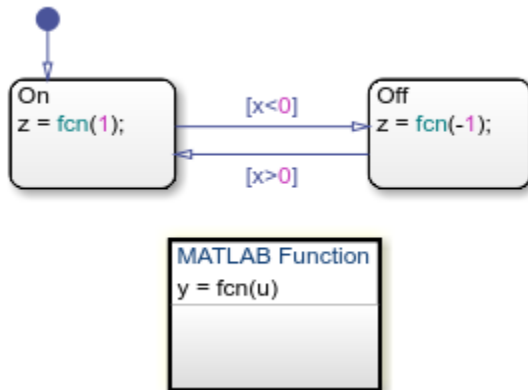

In the MATLAB function:

- The initial value of the persistent variable `n` depends on the input `u`.
- The return statement interrupts the normal control flow of the function.

Because the chart implements Moore semantics, the initialization results in an error.

If you modify the function so it initializes `n` independently of the input, then you can simulate an error-free model.

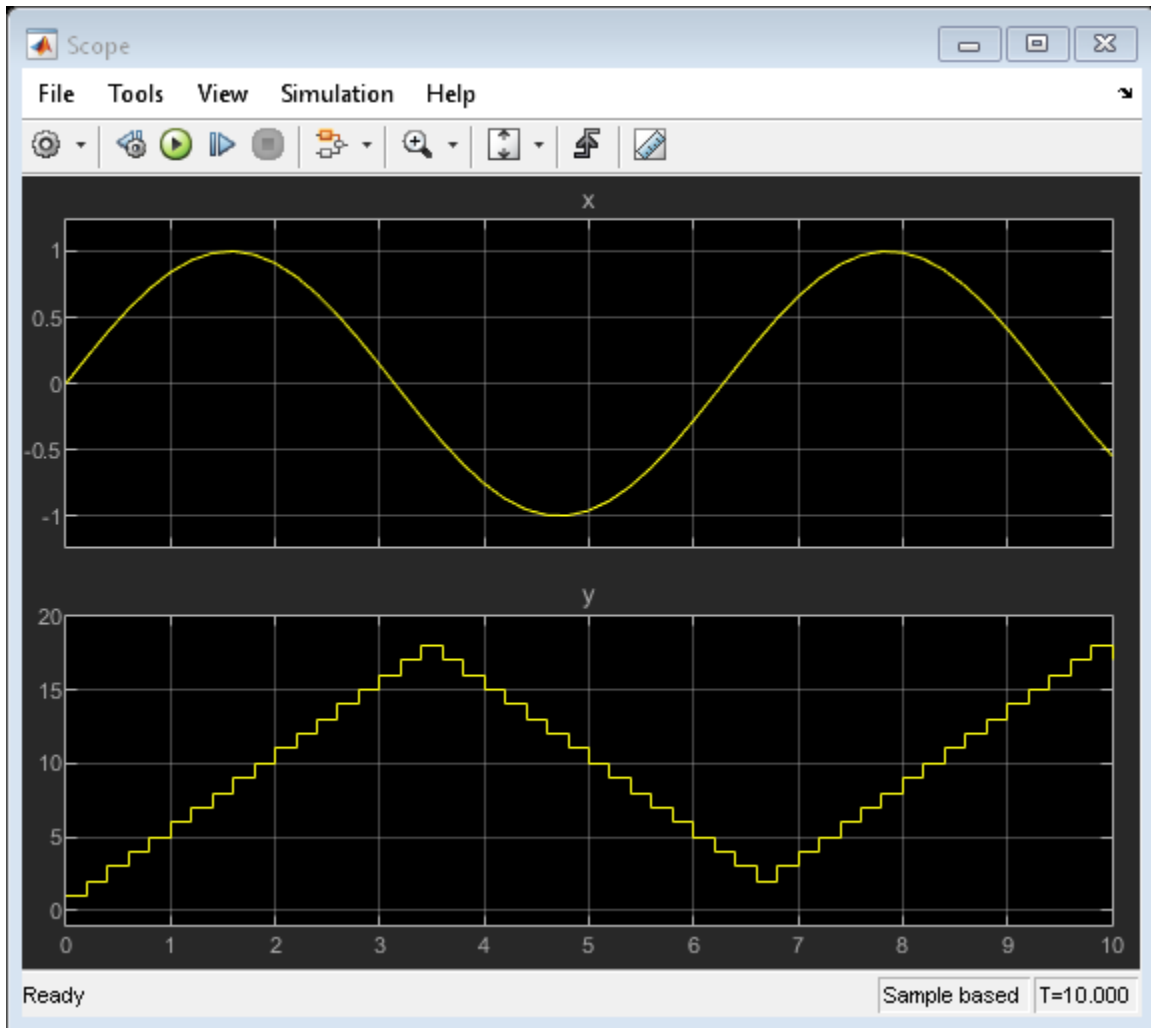

See Also

[Chart](#) | [MATLAB Function](#) | [State Control](#) | [persistent](#)

More About

- “Use Nondirect Feedthrough in a MATLAB Function Block” (Simulink)
- “Synchronous Subsystem Behavior with the State Control Block” (HDL Coder)
- “Design Considerations for Moore Charts” on page 7-9

Techniques for Streamlining Chart Design

- “Record State Activity by Using History Junctions” on page 8-2
- “Encapsulate Modal Logic by Using Subcharts” on page 8-4
- “Move Between Levels of Hierarchy by Using Supertransitions” on page 8-7
- “Reuse Logic Patterns by Defining Graphical Functions” on page 8-13
- “Export Stateflow Functions for Reuse” on page 8-17
- “Group Chart Objects by Using Boxes” on page 8-22
- “Reuse Functions by Using Atomic Boxes” on page 8-28
- “Add Descriptive Comments in a Chart” on page 8-32

Record State Activity by Using History Junctions

A history junction records the activity of substates inside superstates. Use a history junction in a superstate to indicate that its last active substate becomes active when the superstate becomes active. For more information, see “History Junctions” on page 2-36.

Create a History Junction

To create a history junction, do the following:

- 1 In the editor toolbar, click the History Junction icon:



- 2 Move your pointer into the chart.
- 3 Click to place a history junction inside the state whose last active substate it records.

To create multiple history junctions, do the following:

- 1 In the editor toolbar, double-click the History Junction icon.

The button is now in multiple-object mode.

- 2 Click anywhere in the drawing area to place a history junction.
- 3 Move to and click another location to create an additional history junction.
- 4 Click the History Junction icon or press the **Esc** key to cancel the operation.

To move a history junction to a new location, click and drag it to the new position.

Change History Junction Size

To change the size of junctions:

- 1 Select the history junctions whose size you want to change.
- 2 Right-click one of the junctions and select **Junction Size**.
- 3 Select a size from the list of junction sizes.

Change History Junction Properties

To edit the properties for a junction:

- 1 Right-click a junction and select **Properties**.

The History Junction dialog box appears.

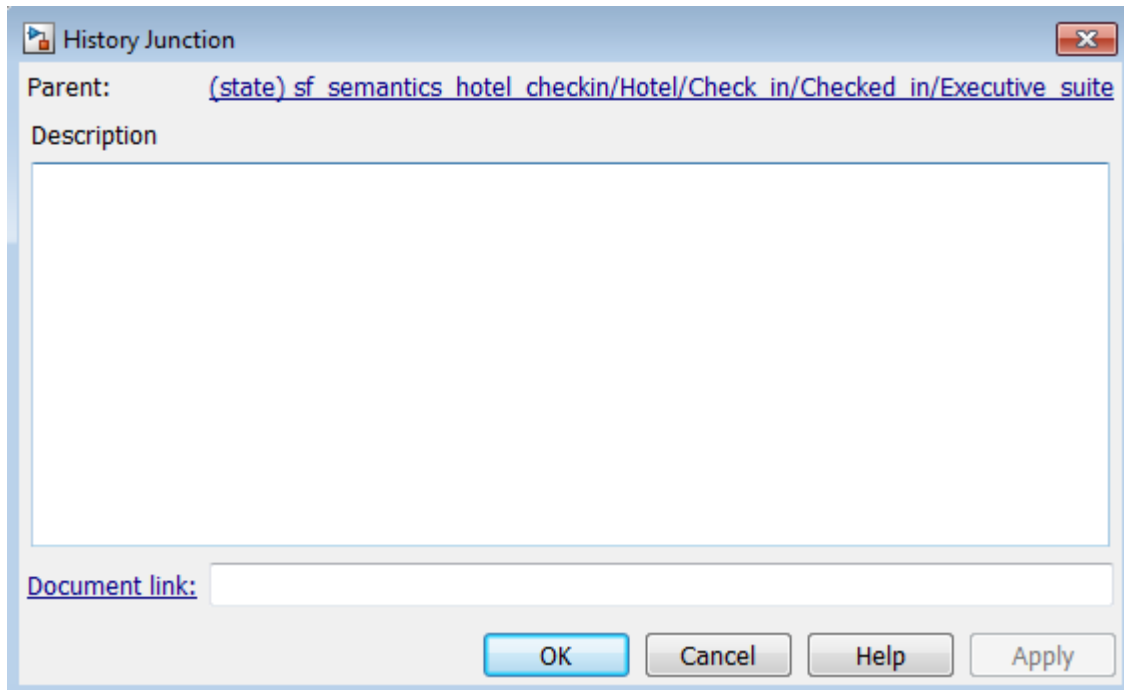

- 2 Edit the fields in the properties dialog box.

Field	Description
Parent	Parent of this history junction; read-only; click the hypertext link to bring the parent to the foreground.
Description	Textual description/comment.
Document Link	Enter a URL address or a general MATLAB command. Examples are <code>www.mathworks.com</code> , <code>mailto:email_address</code> , and <code>edit/spec/data/speed.txt</code> .

- 3 When finished editing, click one of the following buttons:
- **Apply** to save the changes
 - **Cancel** to cancel any changes
 - **OK** to save the changes and close the dialog box
 - **Help** to display the Stateflow online help in an HTML browser window

Encapsulate Modal Logic by Using Subcharts

A subchart is a graphical object that can contain anything that a top-level chart can, including other subcharts. A subchart, or a subcharted state, is a superstate of the states that it contains. You can nest subcharts to any level in your chart design.

Using subcharts, you can reduce a complex chart to a set of simpler, hierarchically organized units. This design makes the chart easier to understand and maintain, without changing the chart behavior. Subchart boundaries do not apply during simulation and code generation.

The subchart appears as a block with its name in the block center. However, you can define actions and default transitions for subcharts just as you can for superstates. You can also create transitions to and from subcharts just as you can create transitions to and from superstates. You can create transitions between states residing outside a subchart and any state within a subchart. The term *supertransition* refers to a transition that crosses subchart boundaries in this way. See “Move Between Levels of Hierarchy by Using Supertransitions” on page 8-7 for more information.

Subcharts define a containment hierarchy within a top-level chart. A subchart or top-level chart is the *parent* of the states it contains at the first level and an *ancestor* of all the subcharts contained by its children and their descendants at lower levels.

Some subcharts can become *atomic* units if they meet certain modeling requirements. For more information, see “Restrictions for Converting to Atomic Subcharts” on page 16-9.

Create a Subchart

You create a subchart by converting an existing state, box, or graphical function into the subchart. The object to convert can be one that you create for making a subchart or an existing object whose contents you want to turn into a subchart.

To convert a new or existing state, box, or graphical function to a subchart:

- 1 Right-click the object and select **Group & Subchart > Subchart**.
- 2 Confirm that the object now appears as a subchart.

To convert the subchart back to its original form, right-click the subchart. In the context menu, select **Group & Subchart > Subchart**.

Rules of Subchart Conversion

When you convert a box to a subchart, the subchart retains the attributes of a box. For example, the position of the resulting subchart determines its activation order in the chart if implicit ordering is enabled (see “Group Chart Objects by Using Boxes” on page 8-22 for more information).

You cannot undo the operation of converting a subchart back to its original form. When you perform this operation, the undo and redo buttons are disabled from undoing and redoing any prior operations.

Convert a State to a Subchart

Suppose that you have the following chart:

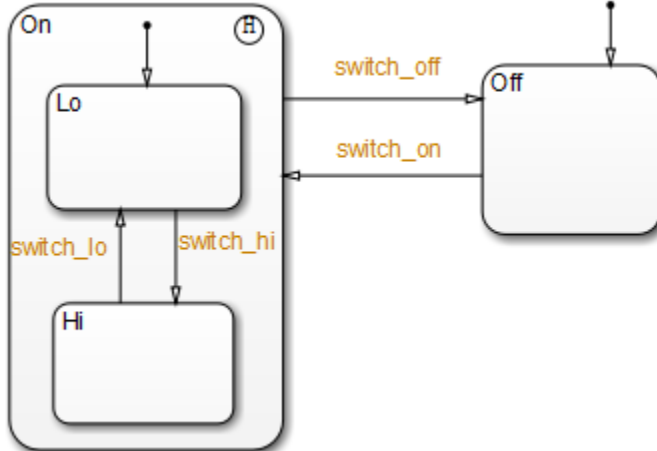

- 1 To convert the On state to a subchart, right-click the state and select **Group & Subchart > Subchart**.
- 2 Confirm that the On state now appears as a subchart.

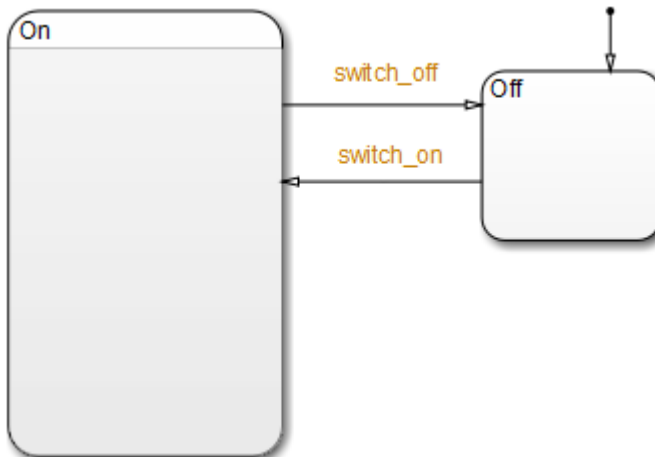

Manipulate Subcharts as Objects

Subcharts also act as individual objects. You can move, copy, cut, paste, relabel, and resize subcharts as you would states and boxes. You can also draw transitions to and from a subchart and any other state or subchart at the same or different levels in the chart hierarchy (see “Move Between Levels of Hierarchy by Using Supertransitions” on page 8-7).

Open a Subchart

Opening a subchart allows you to view and change its contents. To open a subchart, do one of the following:

- Double-click anywhere in the box that represents the subchart.
- Select the box representing the subchart and press the **Enter** key.

Edit a Subchart



After you open a subchart (see “Open a Subchart” on page 8-5), you can perform any editing operation on its contents that you can perform on a top-level chart. This means that you can create, copy, paste, cut, relabel, and resize the states, transitions, and subcharts in a subchart. You can also group states, boxes, and graphical functions inside subcharts.

You can also cut and paste objects between different levels in your chart. For example, to copy objects from a top-level chart to one of its subcharts, first open the top-level chart and copy the objects. Then open the subchart and paste the objects into the subchart.

Transitions from outside subcharts to states or junctions inside subcharts are called *supertransitions*. You create supertransitions differently than you do ordinary transitions. See “Move Between Levels of Hierarchy by Using Supertransitions” on page 8-7 for information on creating supertransitions.

Navigate Subcharts

The Stateflow Editor toolbar contains a set of buttons for navigating the subchart hierarchy of a chart.

Tool	Description
	If the Stateflow Editor is displaying a subchart, clicking this button replaces the subchart with the parent of the subchart in the Stateflow Editor. If the Stateflow Editor is displaying a top-level chart, clicking this button replaces the chart with the Simulink model window containing that chart.
	Clicking this button shows the chart that you visited before the current chart, so that you can navigate up the hierarchy.
	Clicking this button shows the chart that you visited after visiting the current chart, so that you can navigate down the hierarchy.

Note You can also use the **Escape** key to navigate up to the parent object for a subcharted state, box, or function.

Move Between Levels of Hierarchy by Using Supertransitions

A supertransition is a transition between different levels in a chart. A supertransition can be between a state in a top-level chart and a state in one of its substates, or between states residing in different substates. You can create supertransitions that span any number of levels in your chart, for example, from a state at the top level to a state that resides in a subchart several layers deep in the chart.

The point where a supertransition enters or exits a subchart is called a *slit*. Slits divide a supertransition into graphical segments. For example, the `sf_boiler` model shows a supertransition leaving the `On` subchart:

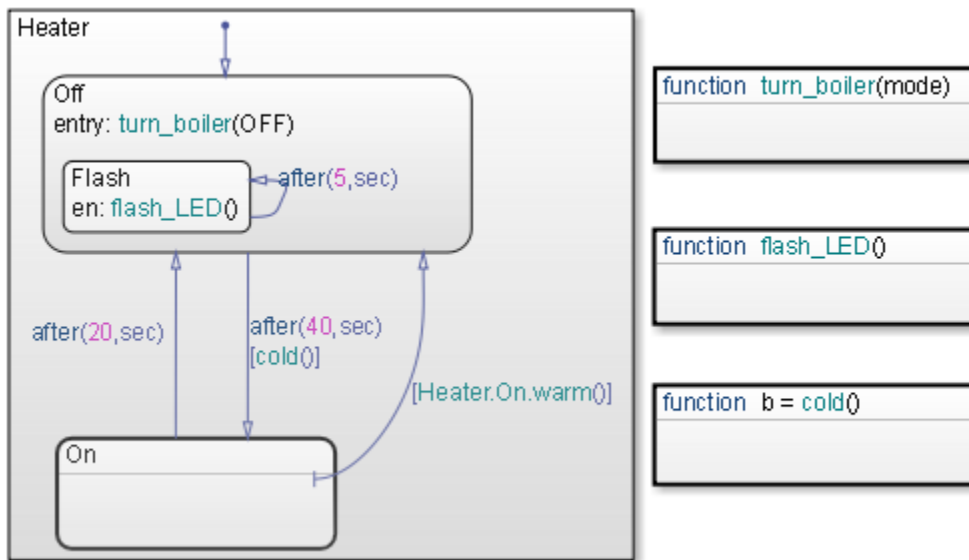

The same supertransition appears inside the subchart as follows:

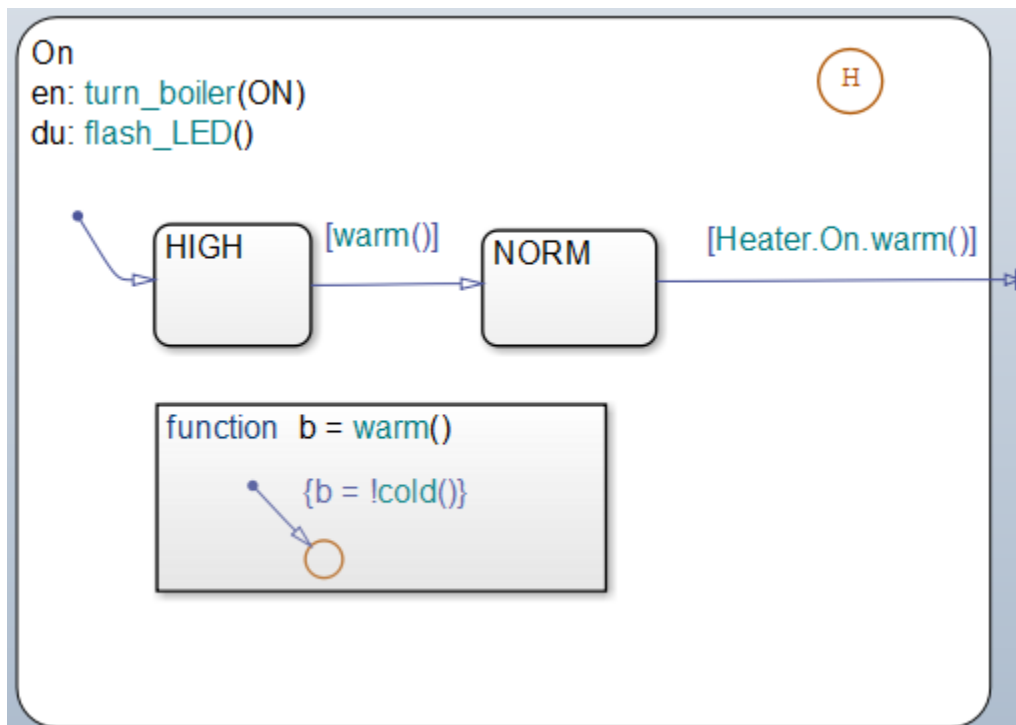

In this example, supertransition [Heater.On.warm()] goes from NORM in the On subchart to the Off state in the parent chart. Both segments of the supertransition have the same label.

Draw a Supertransition Into a Subchart

Use the following steps to draw a supertransition from an object outside a subchart to an object inside the subchart.

Note You cannot undo the operation of drawing a supertransition. When you perform this operation, the undo and redo buttons are disabled from undoing and redoing any prior operations.

- 1 Position your cursor over the border of the state.

The cursor assumes the crosshairs shape.

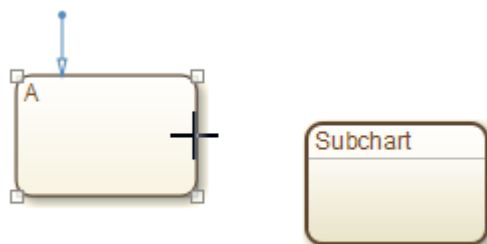

- 2 Drag the mouse just inside the border of the subchart.

A supertransition appears, extending from the source state into the subchart with its arrowhead penetrating a slit in the subchart.

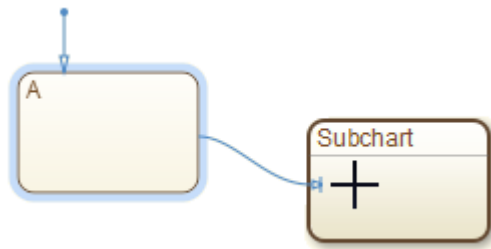

If you are not happy with the initial position of the slit, you can continue to drag the slit around the inside edge of the subchart to the desired location.

- 3 Double-click the subchart to open it.

The tip of the arrowhead of the supertransition appears highlighted in red, entering the subchart.

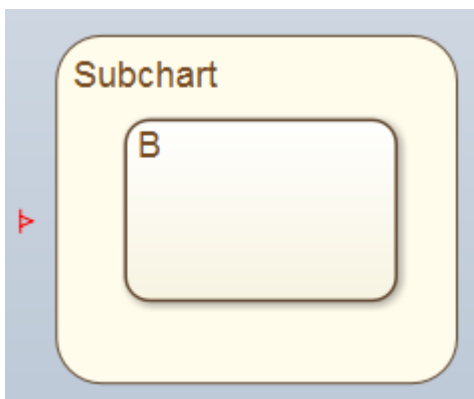

- 4 Position your cursor over the arrowhead.

The cursor becomes an arrow.

- 5 Drag the cursor to the desired position in the subchart.

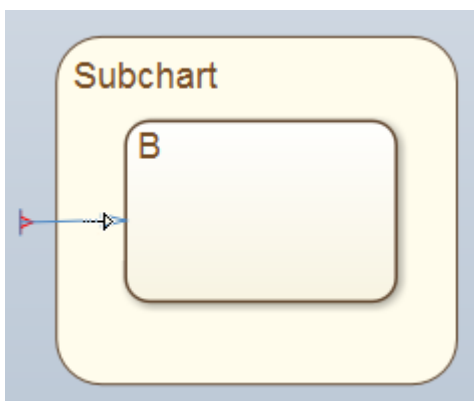

- 6 Release the cursor.

The supertransition terminates in the desired location.

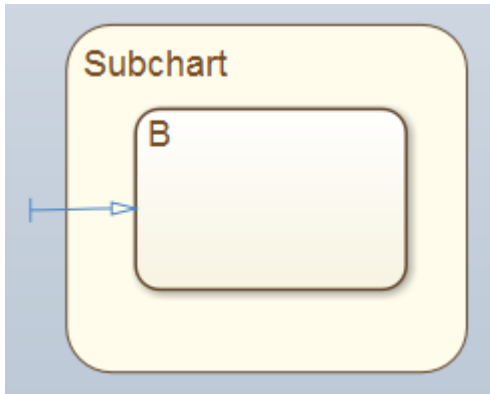

Draw a Supertransition Out of a Subchart

Use the following steps to draw a supertransition out of a subchart.

- 1 Draw an inner transition segment from the source object anywhere just outside the border of the subchart

A slit appears as shown.

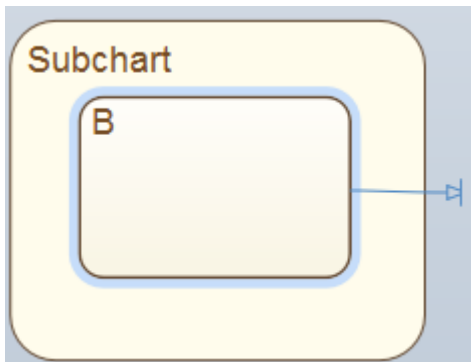

- 2 Navigate up to the parent object.

The tip of the arrowhead of the supertransition appears highlighted in red, exiting the subchart.

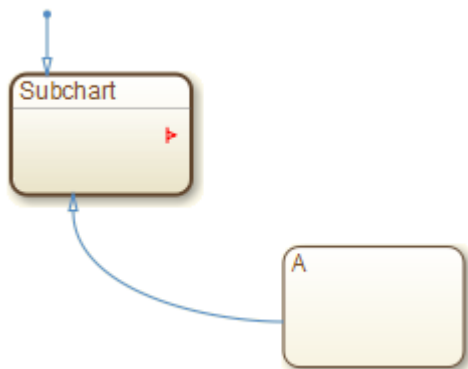

- 3 Position your cursor over the arrowhead.

The cursor becomes an arrow.

- 4 Drag the cursor to the desired position in the chart.

The parent of the subchart appears.

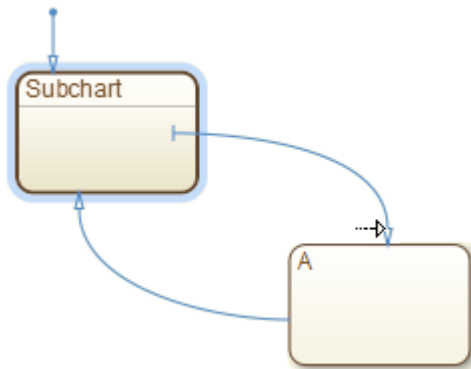

- 5 Release the cursor to complete the connection.

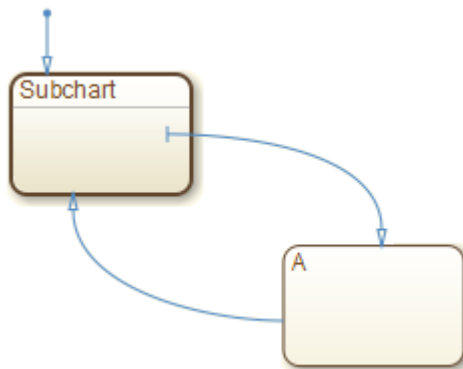

Note If the parent chart is itself a subchart and the terminating object resides at a higher level in the subchart hierarchy, repeat these steps until you reach the desired parent. In this way, you can connect objects separated by any number of layers in the subchart hierarchy.

Label Supertransitions

A supertransition is displayed with multiple resulting transition segments for each layer of containment traversed. For example, if you create a transition between a state outside a subchart and a state inside a subchart of that subchart, you create a supertransition with three segments, each displayed at a different containment level.

You can label any one of the transition segments constituting a supertransition using the same procedure used to label a regular transition (see “Label Transitions” on page 4-14). The resulting

label appears on all the segments that constitute the supertransition. Also, if you change the label on any one of the segments, the change appears on all segments.

Reuse Logic Patterns by Defining Graphical Functions

A *graphical function* in a Stateflow chart is a graphical element that helps you reuse control-flow logic and iterative loops. You create graphical functions with flow charts that use connective junctions and transitions. You can call a graphical function in the actions of states and transitions. With graphical functions, you can:

- Create modular, reusable logic that you can call anywhere in your chart.
- Track simulation behavior visually during chart animation.

A graphical function can reside anywhere in a chart, state, or subchart. The location of the function determines the set of states and transitions that can call the function.

- If you want to call the function only within one state or subchart and its substates, put your graphical function in that state or subchart. That function overrides any other functions of the same name in the parents and ancestors of that state or subchart.
- If you want to call the function anywhere in that chart, put your graphical function at the chart level.
- If you want to call the function from any chart in your model, put your graphical function at the chart level and enable exporting of chart-level functions. For more information, see “Export Stateflow Functions for Reuse” on page 8-17.

For example, this graphical function has the name `f1`. It takes three arguments (`a`, `b`, and `c`) and returns three output values (`x`, `y`, and `z`). The function contains a flow chart that computes three different products of the arguments.

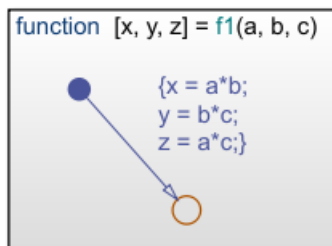

Define a Graphical Function

- 1 In the object palette, click the graphical function icon . Move your pointer to the location for the new graphical function in your chart.
- 2 Enter the signature label for the function, as described in “Declare Function Arguments and Return Values” on page 8-14.
- 3 To program the function, construct a flow chart inside the function box, as described in “Flow Charts in Stateflow” on page 5-2.

Because a graphical function must execute completely when you call it, you cannot use states. Connective junctions and transitions are the only graphical elements that you can use in a graphical function.

- 4 In the Model Explorer, expand the chart object and select the graphical function. The arguments and return values of the function signature appear as data items that belong to your function. Arguments have the scope `Input`. Return values have the scope `Output`.

- 5 In the Data properties dialog box for each argument and return value, specify the data properties, as described in “Set Data Properties” on page 9-5.
- 6 Create any additional data items required by your function. For more information, see “Add Data Through the Model Explorer” on page 9-3.

Your function can access its own data or data belonging to parent states or the chart. The data items in the function can have one of these scopes:

- **Local** — Local data persists from one function call to the next function call. Valid for C charts only.
- **Constant** — Constant data retains its initial value through all function calls.
- **Parameter** — Parameter data retains its initial value through all function calls.
- **Temporary** — Temporary data initializes at the start of every function call. Valid for C charts only.

Initialize Function Data

You can initialize your function data (other than arguments and return values) from the MATLAB workspace. For more information, see “Initialize Data from the MATLAB Base Workspace” on page 9-19.

Define Temporary Data

In charts that use C as the action language, define temporary data when you want to use data that is only valid while a function executes. For example, you can designate a loop counter to have Temporary scope if the counter value does not need to persist after the function completes.

In charts that use MATLAB as the action language, you do not need to define temporary function data. If you use an undefined variable, Stateflow creates a temporary variable. The variable is available to the rest of the function.

Declare Function Arguments and Return Values

The function signature label specifies a name for your function and the formal names for its arguments and return values. A signature label has this syntax:

```
[return_val1,return_val2,...] = function_name(arg1,arg2,...)
```

You can specify multiple return values and multiple input arguments. Each return value and input argument can be a scalar, vector, or matrix of values. For functions with only one return value, omit the brackets in the signature label.

You can use the same variable name for both arguments and return values. For example, a function with this signature label uses the variables `y1` and `y2` as both inputs and outputs:

```
[y1,y2,y3] = f(y1,u,y2)
```

If you export this function to C code, `y1` and `y2` are passed by reference (as pointers), and `u` is passed by value. Passing inputs by reference reduces the number of times that the generated code copies intermediate data, resulting in more optimal code.

Call Graphical Functions in States and Transitions

You can call graphical functions from the actions of any state or transition. You can also call graphical functions from other functions. If you export a graphical function, you can call it from any chart in the model.

The syntax for a call to a graphical function is the same as the function signature, with actual arguments replacing the formal ones specified in a signature. If the data types of an actual and formal argument differ, a function casts the actual argument to the type of the formal argument.

Tip If the formal arguments of a function signature are scalars, verify that inputs and outputs of function calls follow the rules of scalar expansion. For more information, see “Assign Values to All Elements of a Matrix” on page 18-6.

Specify Graphical Function Properties

You can set general properties for your graphical function through its properties dialog box. To open the function properties dialog box, right-click the graphical function box and select **Properties** from the context menu.

Name

Function name. Click the function name link to bring your function to the foreground in its native chart.

Function Inline Option

Controls the inlining of your function in generated code:

- **Auto** — Determines whether to inline your function based on an internal calculation.
- **In line** — Inlines your function if you do not export it to other charts and it is not part of a recursion. (A recursion exists if your function calls itself directly or indirectly through another function call.)
- **Function** — Does not inline your function.

Label

Signature label for your function. For more information, see “Declare Function Arguments and Return Values” on page 8-14.

Description

Function description. You can enter brief descriptions of functions in the hierarchy.

Document Link

Link to online documentation for the function. You can enter a web URL address or a MATLAB command that displays documentation in a suitable online format, such as an HTML file or text in the MATLAB Command Window. When you click the **Document link** hyperlink, Stateflow displays the documentation.

Manage Large Graphical Functions

You can choose to make your graphical function as large as you want. If your function grows too large, you can hide its contents by right-clicking inside the function box and selecting **Group & Subchart > Subchart** from the context menu.

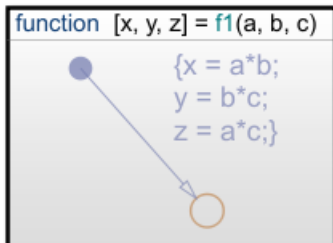

To make the graphical function box opaque, right-click the function and clear the **Content Preview** property from the context menu.

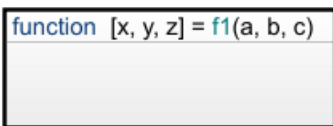

To dedicate the entire chart window to programming your function, access the flow chart in your subcharted graphical function by double-clicking the function box.

Event Broadcasts in Graphical Functions

In a graphical function, do not broadcast events that can cause the active state to change. In a graphical function, the behavior of an event broadcast that causes an exit from the active state is unpredictable.

See Also

More About

- “Flow Charts in Stateflow” on page 5-2
- “Create Flow Charts by Using Pattern Wizard” on page 5-5
- “Reusable Functions in Charts” on page 2-37
- “Export Stateflow Functions for Reuse” on page 8-17
- “Reuse Functions by Using Atomic Boxes” on page 8-28

Export Stateflow Functions for Reuse

When you export chart-level functions, you extend the scope of your functions to other blocks in the Simulink model. For an example, see “Share Functions Across Simulink and Stateflow” on page 30-6. You can export these functions:

- Graphical functions
- MATLAB functions
- Truth tables

How to Export Chart-Level Functions

- 1 Open the chart where your function resides.
- 2 In the Property Inspector, open the **Advanced** section.
- 3 Select **Export Chart Level Functions**.
- 4 If your function resides in a library chart, link that chart to your main model.

When you select **Export Chart Level Functions**, you can call exported functions by using Simulink Caller blocks with dot notation, *chartName.functionName*. To call the exported functions throughout the model from any Stateflow or Simulink Caller block, select **Treat Exported Functions as Globally Visible**. Do not use dot notation to call these functions. You cannot export functions with the same name.

Simulink functions can also be defined directly in the Simulink canvas. For more information, see Simulink Function.

Rules for Exporting Chart-Level Functions

Link library charts to your main model to export chart-level functions from libraries

You must perform this step to export functions from library charts. Otherwise, a simulation error occurs.

Do not export chart-level functions that contain unsupported inputs or outputs

You cannot export a chart-level function when inputs or outputs have any of the following properties:

- Fixed-point data type with word length greater than 32 bits
- Variable size

Do not export Simulink functions

If you try to export Simulink functions, an error appears when you simulate your model. To avoid this behavior, clear the **Export Chart Level Functions** check box in the Chart properties dialog box.

Do not export functions across model reference boundaries

You cannot export functions from a referenced model and call the functions from a parent model.

Export Chart-Level Functions

This example describes how to export functions in library charts to your main model.

1 Create these objects:

- Add a model named `main_model`, with a chart named `modChart`.

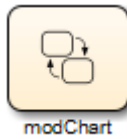

- Add a library model named `lib1`, with a chart named `lib1Chart`.



- Add a library model named `lib2`, with a chart named `lib2Chart`.



2 Create these graphical functions in the library charts:

- For `lib1Chart`, add this graphical function.

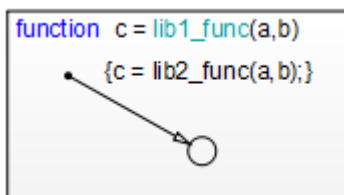

- For `lib2Chart`, add this graphical function.

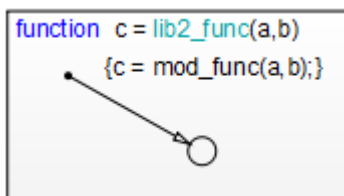

- In the Model Explorer, for each of the function inputs and outputs, `a`, `b`, and `c`, set these properties:
 - Size to 1

- Complexity to Off
 - Type to double
- 3 For modChart, add a graphical function and a default transition with a lib1_func action.

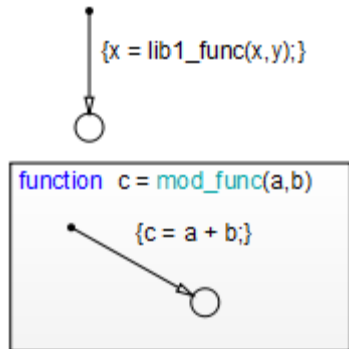

- 4 For each chart, follow these steps:
- a In the Model Explorer, for each of the function inputs and outputs, a, b, and c, set:
 - Size to 1
 - Complexity to Off
 - Type to double
 - b Open the Chart properties dialog box.
 - c In the Chart properties dialog box, select **Export Chart Level Functions** and **Treat Exported Functions as Globally Visible**.
 - d Click **OK**.
- 5 Drag lib1Chart and lib2Chart into main_model from lib1 and lib2, respectively. Your main model should look something like this:

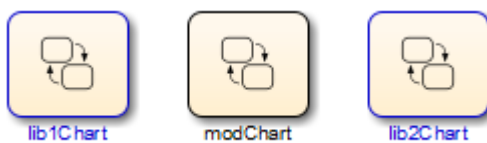

Each chart now defines a graphical function that any chart in main_model can call.

- 6 Open the Model Explorer.
- 7 In the **Model Hierarchy** pane of the Model Explorer, navigate to main_model.
- 8 Add the data x and y to the Stateflow machine:
 - a Select **Add > Data**.
 - b In the **Name** column, enter x.
 - c In the **Initial Value** column, enter 0.
 - d Use the default settings for other properties of x.
 - e Select **Add > Data**.
 - f In the **Name** column, enter y.

- g** In the **Initial Value** column, enter 1.
- h** Use the default settings for other properties of *y*.

This step ensures that input and output data are defined globally to support exported graphical functions.

- 9** Open the Model Configuration Parameters dialog box.
- 10** In the Model Configuration Parameters dialog box, go to the **Solver** pane.
- 11** In the **Solver selection** section, make these changes:
 - a** For **Type**, select Fixed-step.
 - b** For **Solver**, select Discrete (no continuous states).
- 12** In the **Solver details** section, make these changes:
 - a** For **Fixed-step size**, enter 1.
 - b** Click **OK**.

This step ensures that when you simulate your model, a discrete solver is used. For more information, see “Compare Solvers” (Simulink).

What Happens During Simulation

When you simulate the model, these actions take place during each time step.

Phase	The object...	Calls the graphical function...	Which...
1	modChart	lib1_func	Reads two input arguments <i>x</i> and <i>y</i>
2	lib1_func	lib2_func	Passes the two input arguments
3	lib2_func	mod_func	Adds <i>x</i> and <i>y</i> and assigns the sum to <i>x</i>

How to View the Simulation Results

To view the simulation results, add a scope to your model. Follow these steps:

- 1** Open the Simulink Library Browser.
- 2** From the Simulink/Sinks Library, select the Scope block and add it to `main_model`.
- 3** Open the Model Explorer.
- 4** In the **Model Hierarchy** pane, navigate to `modChart`.
- 5** Add the output data *z* to the chart:
 - a** Select **Add > Data**.
 - b** In the **Name** column, enter *z*.
 - c** In the **Scope** column, select Output.
 - d** Use the default settings for other properties.
- 6** For `modChart`, update the default transition action to read as follows:

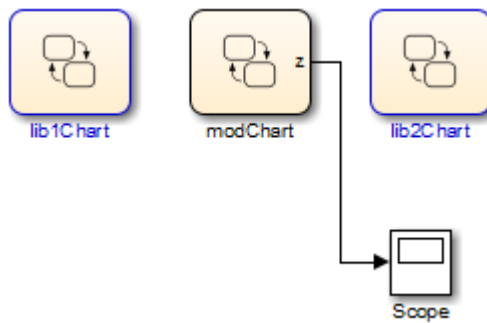

```
{x = lib1_func(x,y); z = x;}
```

- 7 In the model, connect the output from modChart to the inport of the Scope block.

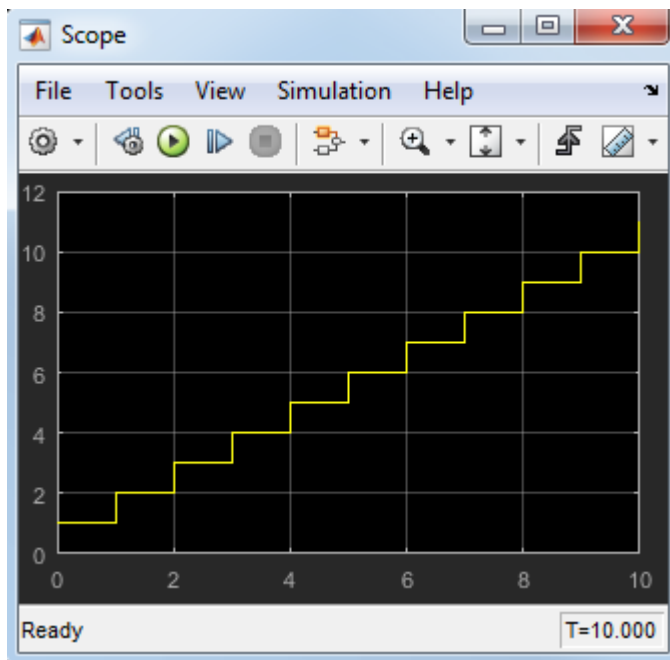

- 8 Double-click the Scope block to open the display.
- 9 Start simulation.
- 10 After the simulation ends, right-click in the scope display and select **Autoscale**.

The results look something like this:



Group Chart Objects by Using Boxes

A box is a graphical object that organizes other objects in your chart, such as functions and states. You can use a box to encapsulate states and functions in a separate namespace. Boxes are supported only in Stateflow charts in Simulink models.

For example, in this chart, the box Heater groups together related states Off and On.

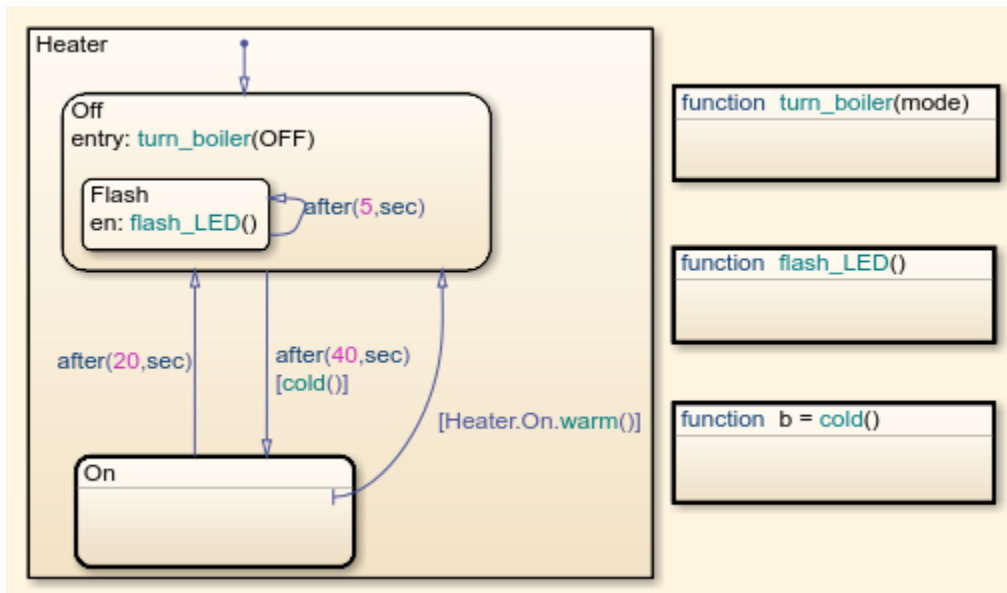

Semantics of Stateflow Boxes

Visibility of Graphical Objects in Boxes

Boxes add a level of hierarchy to Stateflow charts. This property affects visibility of functions and states inside a box to objects that reside outside of the box. If you refer to a box-parented function or state from a location outside of the box, you must include the box name in the path. See “Group Functions Using a Box” on page 8-25.

Activation Order of Parallel States

Boxes affect the implicit activation order of parallel states in a chart. If your chart uses implicit ordering, parallel states within a box wake up before other parallel states that are lower or to the right in that chart. Within a box, parallel states wake up in top-down, left-right order. See “Group States Using a Box” on page 8-25.

Note To specify activation order explicitly on a state-by-state basis, select **User-specified state/transition execution order** in the Chart properties dialog box. This option is selected by default when you create a new chart. For details, see “Explicit Ordering of Parallel States” on page 3-58.

Rules for Using Boxes

When you use a box, these rules apply:

- Include the box name in the path when you use dot notation to refer to a box-parented function or state from a location outside of the box.
- You can move or draw graphical objects inside a box, such as functions and states.
- You can add data to a box so that all the elements in the box can share the same data.
- You can group a box and its contents into a single graphical element. See “Group States” on page 4-6.
- You can subchart a box to hide its elements. See “Encapsulate Modal Logic by Using Subcharts” on page 8-4.
- You cannot define action statements for a box, such as `entry`, `during`, and `exit` actions.
- You cannot define a transition to or from a box. However, you can define a transition to or from a state within a box.

Draw and Edit a Box

Create a Box

You create boxes in your chart by using the box tool shown below.

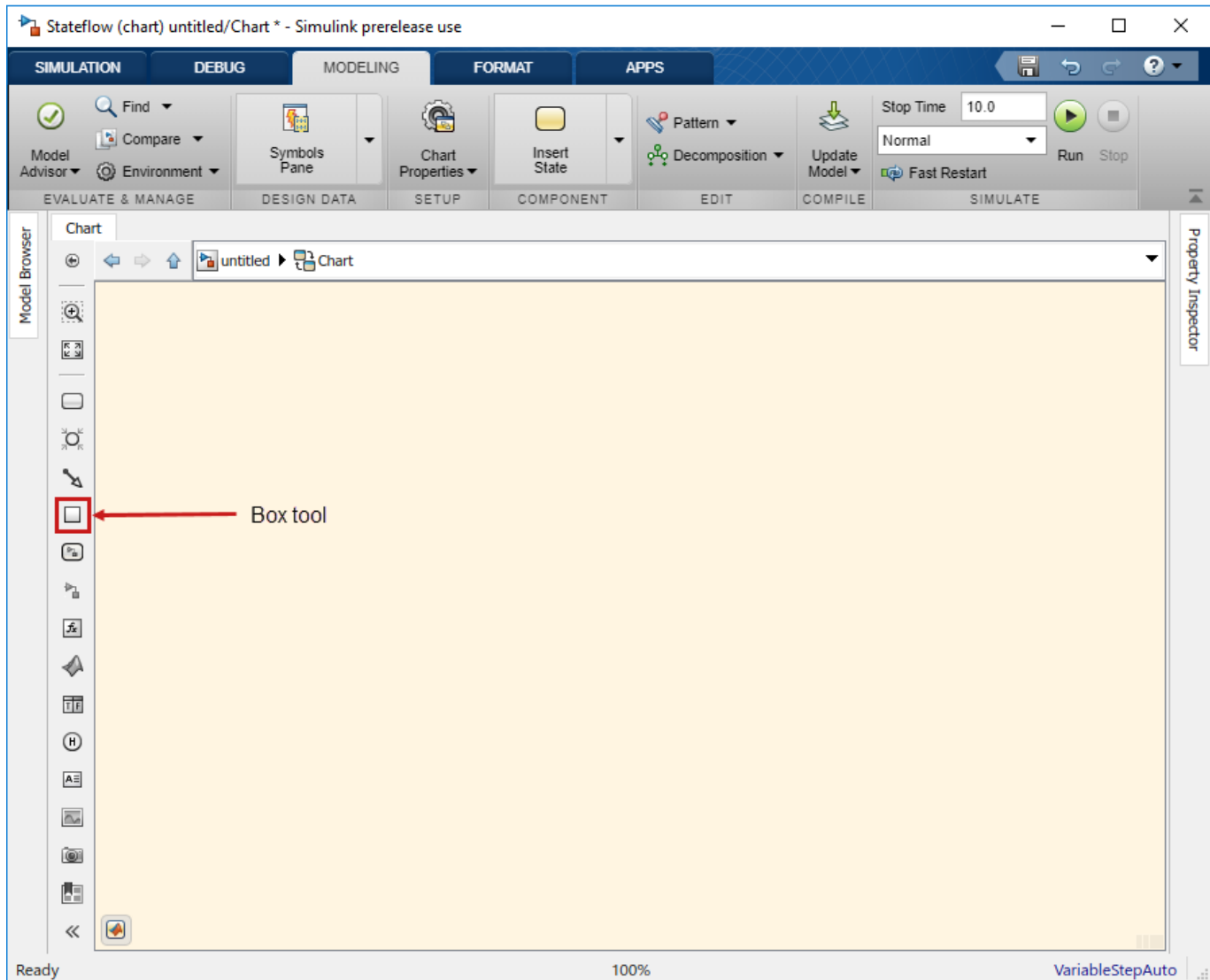

- 1 Click the Box tool.
- 2 Move your pointer into the drawing area.
- 3 Click in any location to create a box.

The new box appears with a question mark (?) name in its upper left corner.

- 4 Click the question mark label.
- 5 Enter a name for the box and then click outside of the box.

Delete a Box

To delete a box, click to select it and press the **Delete** key.

Examples of Using Boxes

Group Functions Using a Box

This chart shows a box named `Status` that groups together MATLAB functions.

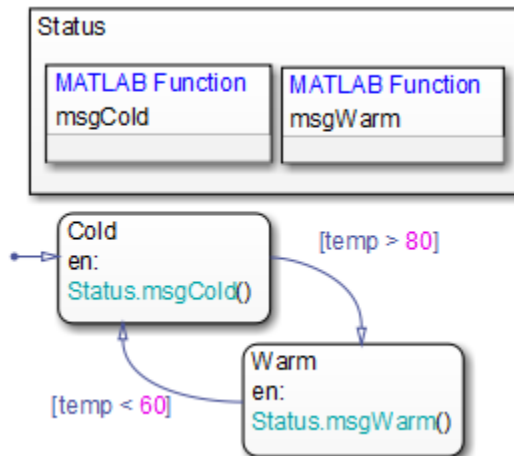

Chart execution takes place as follows:

- 1 The state `Cold` activates first.
- 2 Upon entry, the state `Cold` invokes the function `Status.msgCold`.

This function displays a status message that the temperature is cold.

Note Because the MATLAB function resides inside a box, the path of the function call must include the box name `Status`. If you omit this prefix, an error message appears.

- 3 If the value of the input data `temp` exceeds 80, a transition to the state `Warm` occurs.
- 4 Upon entry, the state `Warm` invokes the function `Status.msgWarm`.

This function displays a status message that the temperature is warm.

Note Because the MATLAB function resides inside a box, the path of the function call must include the box name `Status`. If you omit this prefix, an error message appears.

- 5 If the value of the input data `temp` drops below 60, a transition to the state `Cold` occurs.
- 6 Steps 2 through 5 repeat until the simulation ends.

Group States Using a Box

This chart shows a box named `Status` that groups together related states. The chart uses implicit ordering for parallel states, instead of the default explicit mode. (For details, see “Implicit Ordering of Parallel States” on page 3-59.)

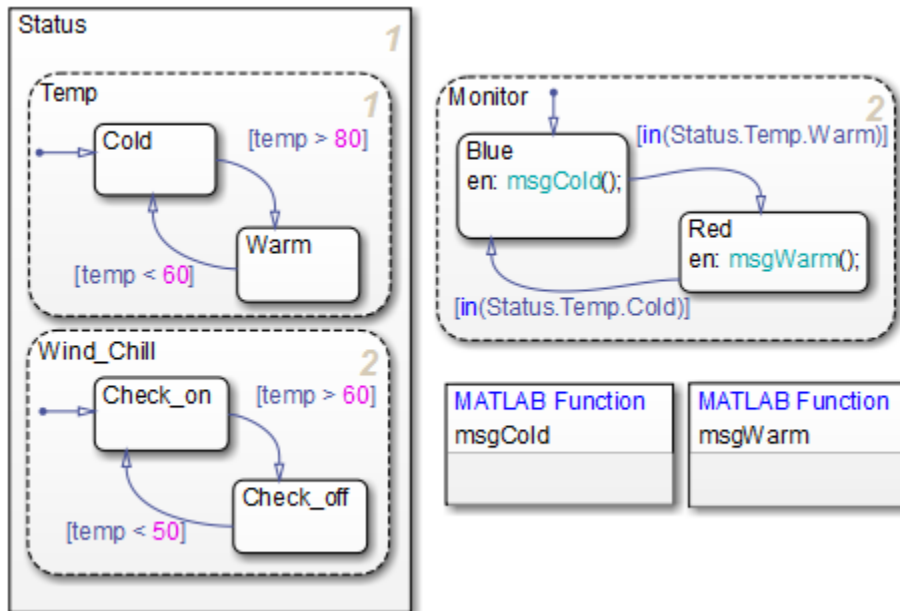

The main ideas of this chart are:

- The state `Temp` wakes up first, followed by the state `Wind_Chill`. Then, the state `Monitor` wakes up.

Note This implicit activation order occurs because `Temp` and `Wind_Chill` reside in a box. If you remove the box, the implicit activation order changes, as shown, to: `Temp`, `Monitor`, `Wind_Chill`.

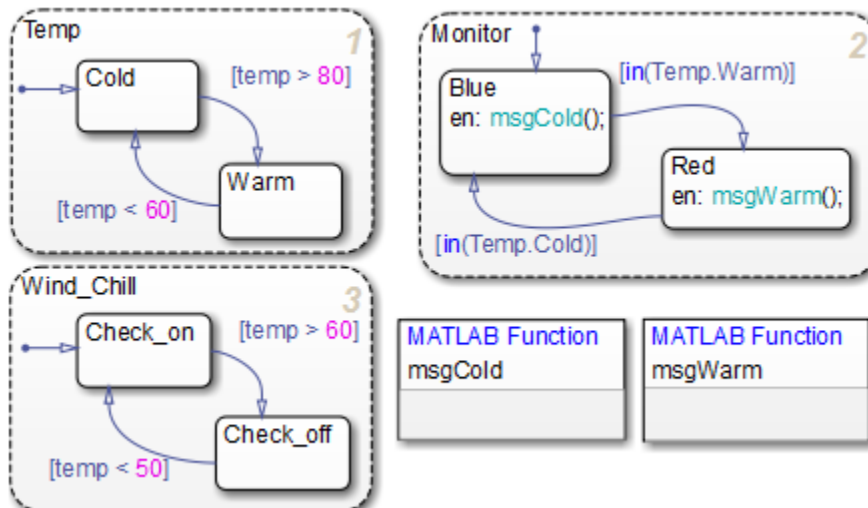

- Based on the input data `temp`, transitions between substates occur in the parallel states `Status.Temp` and `Status.Wind_Chill`.
- When the transition from `Status.Temp.Cold` to `Status.Temp.Warm` occurs, the transition condition `in(Status.Temp.Warm)` becomes true.

- When the transition from `Status.Temp.Warm` to `Status.Temp.Cold` occurs, the transition condition `in(Status.Temp.Cold)` becomes true.

Note Because the substates `Status.Temp.Cold` and `Status.Temp.Warm` reside inside a box, the argument of the `in` operator must include the box name `Status`. If you omit this prefix, an error message appears. For information about the `in` operator, see “Check State Activity by Using the `in` Operator” on page 10-14.

Reuse Functions by Using Atomic Boxes

An atomic box is a graphical object that helps you encapsulate graphical, truth table, MATLAB, and Simulink functions in a separate namespace. Atomic boxes are supported only in Stateflow charts in Simulink models. Atomic boxes allow for:

- Faster simulation after making small changes to a function in a chart with many states or levels of hierarchy.
- Reuse of the same functions across multiple charts and models.
- Ease of team development for people working on different parts of the same chart.
- Manual inspection of generated code for a specific function in a chart.

An atomic box looks opaque and includes the label **Atomic** in the upper left corner. If you use a linked atomic box from a library, the label **Link** appears in the upper left corner.

Example of an Atomic Box

This example shows how to use a linked atomic box to reuse a graphical function across multiple charts and models.

The function `GetTime` is defined in a chart in the library model `sf_timer_utils_lib`. The graphical function returns the simulation time in C charts where the equivalent MATLAB® function `getSimulationTime` is not available.

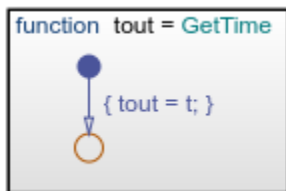

The model `sf_timer_function_calls` consists of two charts with a similar structure. Each chart contains a pair of states (A and B) and an atomic box (`Time`) linked from the library chart. The entry action in state A calls the function `GetTime` and stores its value as `t0`. The condition guarding the transition from A to B calls the function again and compares its output with the parameter `T`.

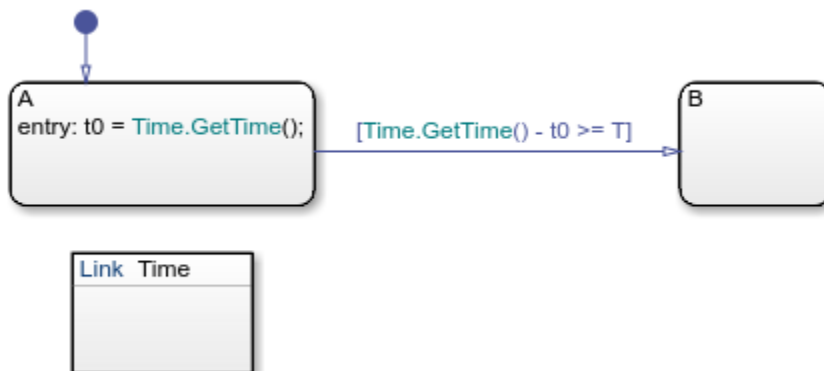

The top model `sf_timer_modelref` reuses the timer function in multiple referenced blocks. Because there are no exported functions, you can use more than one instance of the referenced block in the top model.

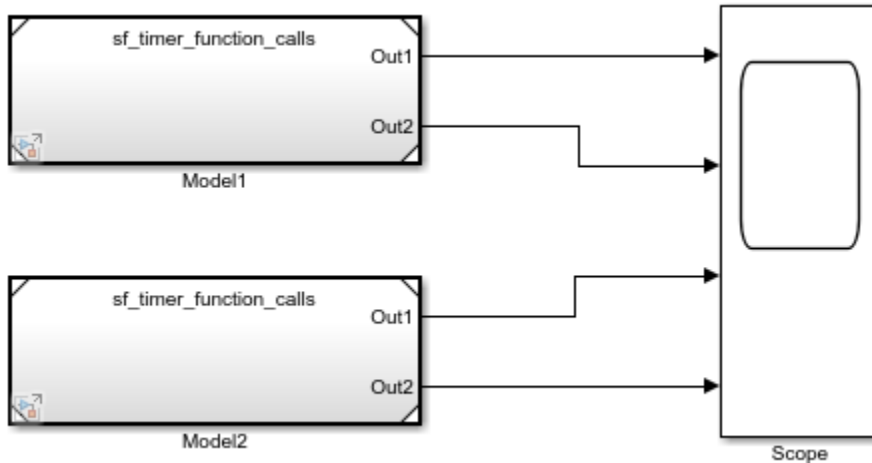

Benefits of Using Atomic Boxes

Atomic boxes combine the functionality of normal boxes and atomic subcharts. Atomic boxes:

- Improve the organization and clarity of complex charts.
- Support usage as library links.
- Support the generation of reusable code.
- Allow mapping of inputs, outputs, parameters, data store memory, and input events.

Atomic boxes contain only functions. They cannot contain states. Adding a state to an atomic box results in a compilation-time error.

To call a function that resides in an atomic box from a location outside the atomic box, use dot notation to specify its full path:

atomic_box_name.function_name

Using the full path for the function call:

- Makes clear the dependency on the function in the linked atomic box.
- Avoids pollution of the global namespace.
- Does not affect the efficiency of generated code.

Create an Atomic Box

You can create an atomic box by converting an existing box or by linking a chart from a library model. After creating the atomic box, update the mapping of variables by right-clicking the atomic box and selecting **Subchart Mappings**. For more information, see “Map Variables for Atomic Subcharts and Boxes” on page 16-11.

Convert a Normal Box to an Atomic Box

To create a container for your functions that allows for faster debugging and code generation workflows, convert an existing box into an atomic box. In your chart, right-click a normal box and select **Group & Subchart > Atomic Subchart**. The label **Atomic** appears in the upper left corner of the box.

The conversion process gives the atomic box its own copy of every data object that the box accesses in the chart. Local data is copied as data store memory. The scope of other data, including input and output data, does not change.

Note If a box contains any states or messages, you cannot convert it to an atomic box.

Link an Atomic Box from a Library

To create a collection of functions for reuse across multiple charts and models, create a link from a library model. Copy a chart in a library model and paste it to a chart in another model. If the library chart contains only functions and no states, it appears as a linked atomic box with the label **Link** in the upper left corner.

This modeling method minimizes maintenance of reusable functions. When you modify the atomic box in the library, your changes propagate to the links in all charts and models.

If the library chart contains any states, then it appears as a linked atomic subchart in the chart. For more information, see “Create Reusable Subcomponents by Using Atomic Subcharts” on page 16-2.

Convert an Atomic Box to a Normal Box

Converting an atomic box back to a normal box removes all of its variable mappings by merging subchart-parented data objects with the chart-parented data to which they map.

- 1 If the atomic box is a library link, right-click the atomic box and select **Library Link > Disable Link**.
- 2 To convert an atomic box to a subcharted box, right-click the atomic box and clear the **Group & Subchart > Atomic Subchart** check box.
- 3 To convert the subcharted box back to a normal box, right-click the subchart and clear the **Group & Subchart > Subchart** check box.
- 4 If necessary, rearrange graphical objects in your chart.

You cannot convert an atomic box to a normal box if:

- The atomic box maps a parameter to an expression other than a single variable name. For example, mapping a parameter `data1` to one of these expressions prevents the conversion of an atomic box to a normal box:
 - 3
 - `data2(3)`
 - `data2 + 3`
- Both of these conditions are true:
 - The atomic box contains MATLAB functions or truth table functions that use MATLAB as the action language.

- The atomic box does not map each variable to a variable of the same name in the main chart.

When to Use Atomic Boxes

Debug Functions Incrementally

Suppose that you want to test a sequence of changes to a library of functions. The functions are part of a chart that contains many states or several levels of hierarchy, so recompiling the entire chart can take a long time. If you define the functions in an atomic box, recompilation occurs for only the box and not for the entire chart. For more information, see “Reduce the Compilation Time of a Chart” on page 16-29.

Reuse Functions

Suppose that you have a set of functions for use in multiple charts and models. The functions reside in the library model to enable easier configuration management. To use the functions in another model, you can either:

- Configure the library chart to export functions and create a link to the library chart in the model.
- Link the library chart as an atomic box in each chart of the model.

Models that use these functions can appear as referenced blocks in a top model. When the functions are exported, you can use only one instance of that referenced block for each top model. For more information, see “Model Reference Requirements and Limitations” (Simulink).

With atomic boxes, you can avoid this limitation. Because there are no exported functions in the charts, you can use more than one instance of the referenced block in the top model.

Develop Charts Used by Multiple People

Suppose that multiple people are working on different parts of a chart. If you store each library of functions in a linked atomic box, different people can work on different libraries without affecting the other parts of the chart. For more information, see “Divide a Chart into Separate Units” on page 16-32.

Inspect Generated Code

Suppose that you want to inspect code generated by Simulink Coder or Embedded Coder manually for a specific function. You can specify that the code for an atomic box appears in a separate file to avoid searching through unrelated code. For more information, see “Generate Code from Atomic Subcharts” on page 32-14.

See Also

More About

- “Group Chart Objects by Using Boxes” on page 8-22
- “Create Reusable Subcomponents by Using Atomic Subcharts” on page 16-2
- “Map Variables for Atomic Subcharts and Boxes” on page 16-11

Add Descriptive Comments in a Chart

You can enter comments or annotations in any location on a Stateflowchart. Annotations can contain any combination of:

- Text.
- Images.
- Equations using TeX commands.
- Hyperlinks that open a website or perform MATLAB functions. See “Describe Models Using Notes and Annotations” (Simulink).

To create an annotation:

- 1 Double-click in the desired location of the chart. An annotation box opens.
- 2 In the annotation box, type your comments. To start a new line, press the **Enter** key.
- 3 After you finish typing, click outside the annotation box.

Change Annotation Properties

You can change the style of an existing annotation by using the annotation formatting toolbar, the annotation context menu, or the Annotation properties dialog box.

- To access the annotation formatting toolbar, double-click the annotation text. Buttons on the formatting toolbox enable you to change font styles, text alignment, colors, and other options. For more information, see “Describe Models Using Notes and Annotations” (Simulink).



- To open the annotation context menu, right-click the annotation text and select one of these options:
 - **Format** — choose font size, style (bold or italics), and whether to display a drop shadow around the annotation text.
 - **Text Alignment** — choose between left, center, and right justified text.
 - **Enable TeX Commands** — include TeX formatting commands in the annotation text. See “Include TeX Formatting Instructions” on page 8-33.
- To open the Annotation properties dialog box, right-click the annotation text and select **Properties**. You can specify the layout of the annotation, including:
 - Fixed height and width options.
 - Text and background color.
 - Text alignment.
 - Margins between the text and the border of the annotation.

Include TeX Formatting Instructions

In your annotations, you can embed a subset of TeX commands to produce special characters such as Greek letters and mathematical symbols. For example, suppose that you enter this annotation text:

```
\it{\omega_N = e^{\{-2\pii\}/N}}
```

When you select the **Enable TeX Commands** annotation property, the chart renders this annotation like this:

$$\omega_N = e^{(-2\pi)/N}$$

For a list of more information on using TeX commands in annotations, see “Describe Models Using Notes and Annotations” (Simulink).

See Also

More About

- “Describe Models Using Notes and Annotations” (Simulink)

Define Data

- “Add Stateflow Data” on page 9-2
- “Set Data Properties” on page 9-5
- “Share Data with Simulink and the MATLAB Workspace” on page 9-19
- “Share Parameters with Simulink and the MATLAB Workspace” on page 9-21
- “Access Data Store Memory from a Chart” on page 9-23
- “Specify Type of Stateflow Data” on page 9-27
- “Specify Size of Stateflow Data” on page 9-33
- “Handle Integer Overflow for Chart Data” on page 9-36
- “Identify Data by Using Dot Notation” on page 9-39
- “Resolve Data Properties from Simulink Signal Objects” on page 9-43

Add Stateflow Data

When you want to store values that are visible at a specific level of the Stateflow hierarchy, add data to your chart.

Data defined in a Stateflow chart is visible by multiple Stateflow objects in the chart, including states, transitions, MATLAB functions, and truth tables. To determine what data is used in a state or transition, right-click the state or transition and select **Explore**. A context menu lists the names and scopes of all resolved symbols in the state or transition. Selecting a symbol from the context menu displays its properties in the Model Explorer. Selecting an output event from the context menu opens the Simulink subsystem or Stateflow chart associated with the event.

Note Stateflow data is not available to Simulink functions within a Stateflow chart.

You can add data to a Stateflow chart by using the Symbols pane, the Stateflow Editor menu, or the Model Explorer.

Add Data Through the Symbols Pane

- 1 In the **Modeling** tab, under **Design Data**, select **Symbols Pane**.
- 2 Click the **Create Data** icon .
- 3 In the row for the new data, under **TYPE**, click the icon and choose:
 - Input Data
 - Local Data
 - Output Data
 - Constant
 - Data Store Memory
 - Parameter
 - Temporary
- 4 Edit the name of the data.
- 5 For input and output data, click the **PORT** field and choose a port number.
- 6 To specify properties for data, open the Property Inspector. In the Symbols pane, right-click the row for the symbol and select **Explore**. For more information, see “Stateflow Data Properties” on page 9-5.

Add Data by Using the Stateflow Editor Menu

- 1 In a Stateflow chart in a Simulink model, select the menu option corresponding to the scope of the data that you want to add.

Scope	Menu Option
Input	In the Modeling tab, under Design Data , select Data Input .
Output	In the Modeling tab, under Design Data , select Data Output .

Scope	Menu Option
Local	In the Modeling tab, under Design Data , select Local .
Constant	In the Modeling tab, under Design Data , select Constant .
Parameter	In the Modeling tab, under Design Data , select Parameter .
Data Store Memory	In the Modeling tab, under Design Data , select Data Store .

- In the Data dialog box, specify data properties. For more information, see “Stateflow Data Properties” on page 9-5.

Add Data Through the Model Explorer

To add machine or state-parented data to Stateflow charts in Simulink models, use the Model Explorer:

- In the **Modeling** tab, under **Design Data**, select **Model Explorer**.
- In the **Model Hierarchy** pane, select the object in the Stateflow hierarchy where you want to make the new data visible. The object that you select becomes the parent of the new data.
- In the Model Explorer menu, select **Add > Data**. The new data with a default definition appears in the **Contents** pane of the Model Explorer.
- In the **Data** pane, specify the properties of the data. For more information, see “Stateflow Data Properties” on page 9-5.

Best Practices for Using Data in Charts

Avoid Inheriting Output Data Properties from Simulink Blocks

Stateflow output data should not inherit properties from output signals, because the values back propagate from Simulink blocks and can be unpredictable.

Restrict Use of Machine-Parented Data

Avoid using machine-parented data. The presence of machine-parented data in a model prevents reuse of generated code and other code optimizations. This type of data is also incompatible with many Simulink and Stateflow features.

For example, the following features do not support machine-parented data:

- Enumerated data
- Simulink functions
- Chart operating point
- Implicit change events
- Detection of unused data
- Model referencing (see “Model Reference Requirements and Limitations” (Simulink))
- Analysis by Simulink Design Verifier™ software
- Code generation by Simulink PLC Coder™ software
- Parameters binding to a `Simulink.Parameter` object in the base workspace

To make Stateflow data accessible to other charts and blocks in a model, use data store memory. For details, see “Access Data Store Memory from a Chart” on page 9-23.

See Also

More About

- “Set Data Properties” on page 9-5
- “Specify Type of Stateflow Data” on page 9-27
- “Manage Data, Events, and Messages in the Symbols Pane” on page 34-2
- “Resolve Undefined Symbols in Your Chart” on page 31-24

Set Data Properties

When you create Stateflow charts in Simulink, you can specify data properties in either the Property Inspector or the Model Explorer.

- To use the Property Inspector:
 - 1 In the **Modeling** tab, under **Design Data**, select **Symbols Pane** and **Property Inspector**.
 - 2 In the Symbols pane, select the data object.
 - 3 In the Property Inspector pane, edit the data properties.
- To use the Model Explorer:
 - 1 In the **Modeling** tab, under **Design Data**, select **Model Explorer**.
 - 2 In the **Contents** pane, select the data object.
 - 3 In the **Message** pane, edit the data properties.

Properties vary according to the scope and type of the data object. For many data properties, you can enter expressions or parameter values. Using parameters to set properties for many data objects simplifies maintenance of your model because you can update multiple properties by changing a single parameter.

Stateflow Data Properties

You can set these data properties in:

- The main and **Advanced** sections of the Property Inspector.
- The **General** tab of the Model Explorer.

Name

Name of the data object. For more information, see “Rules for Naming Stateflow Objects” on page 2-5.

Scope

Location where data resides in memory, relative to its parent.

Setting	Description
Local	Data defined in the current chart only.
Constant	Read-only constant value that is visible to the parent Stateflow object and its children.
Parameter	Constant whose value is defined in the MATLAB base workspace or derived from a Simulink block parameter that you define and initialize in the parent masked subsystem. The Stateflow data object must have the same name as the MATLAB variable or the Simulink parameter. For more information, see “Share Parameters with Simulink and the MATLAB Workspace” on page 9-21.

Setting	Description
Input	Input argument to a function if the parent is a graphical function, truth table, or MATLAB function. Otherwise, the Simulink model provides the data to the chart through an input port on the Stateflow block. For more information, see “Share Input and Output Data with Simulink” on page 9-19.
Output	Return value of a function if the parent is a graphical function, truth table, or MATLAB function. Otherwise, the chart provides the data to the Simulink model through an output port on the Stateflow block. For more information, see “Share Input and Output Data with Simulink” on page 9-19.
Data Store Memory	Data object that binds to a Simulink data store, which is a signal that functions like a global variable. All blocks in a model can access that signal. This binding allows the chart to read and write to the Simulink data store, sharing global data with the model. The Stateflow object must have the same name as the Simulink data store. For more information, see “Access Data Store Memory from a Chart” on page 9-23.
Temporary	Data that persists during only the execution of a function. For C charts, you can define temporary data only for a graphical function, truth table, or MATLAB function.
Exported	Data from the Simulink model that is made available to external code defined in the Stateflow hierarchy. You can define exported data only for a Stateflow machine.
Imported	Data parented by the Simulink model that you define in external code embedded in the Stateflow machine. You can define imported data only for a Stateflow machine.

Port

Index of the port associated with the data object. This property applies only to input and output data. See “Share Input and Output Data with Simulink” on page 9-19.

Update Method

Specifies whether a variable updates in discrete or continuous time. This property applies only when the chart is configured for continuous-time simulation. See “Continuous-Time Modeling in Stateflow” on page 22-2.

Data Must Resolve to Signal Object

Specifies that output or local data explicitly inherits properties from `Simulink.Signal` objects of the same name in the MATLAB base workspace or the Simulink model workspace. The data can inherit these properties:

- Size
- Complexity
- Type
- Unit
- Minimum value

- Maximum value
- Initial value
- Storage class
- Sampling mode (for Truth Table block output data)

This option is available only when you set the model configuration parameter **Signal resolution** to a value other than **None**. For more information, see “Resolve Data Properties from Simulink Signal Objects” on page 9-43.

Size

Size of the data object. The size can be a scalar value or a MATLAB vector of values.

- To specify a scalar, set the **Size** property to 1 or leave the field blank.
- To specify an n -by-1 column vector, set the **Size** property to n .
- To specify a 1-by- n row vector, set the **Size** property to $[1 \ n]$.
- To specify an n -by- m matrix, set the **Size** property to $[n \ m]$.
- To specify an n -dimensional array, set the **Size** property to $[d_1 \ d_2 \ \dots \ d_n]$, where d_i is the size of the i^{th} dimension.
- To configure a Stateflow data object to inherit its size from the corresponding Simulink signal or from its definition in the chart, specify a size of -1 .

The scope of the data object determines what sizes you can specify. Stateflow data store memory inherits all its properties, including its size, from the Simulink data store to which it is bound. For all other scopes, size can be scalar, vector, or a matrix of n -dimensions. For more information, see “Specify Size of Stateflow Data” on page 9-33.

You can specify data size through a MATLAB expression that evaluates to a valid size specification. For more information, see “Specify Data Size by Using Expressions” on page 9-34 and “Specify Data Properties by Using MATLAB Expressions” on page 9-16.

Variable Size

Specifies that the data object changes dimensions during simulation. This option is available for input and output data only when you enable the chart property **Support variable-size arrays**. For more information, see “Declare Variable-Size Data in Stateflow Charts” on page 19-2.

Complexity

Specifies whether the data object accepts complex values.

Setting	Description
Off	Data object does not accept complex values.
On	Data object accepts complex values.
Inherited	Data object inherits the complexity setting from a Simulink block.

The default value is **Off**. For more information, see “Complex Data in Stateflow Charts” on page 24-2.

First Index

Index of the first element of the data array. The first index can be any integer. The default value is 0. This property is available only for C charts.

Type

Type of data object. To specify the data type:

- From the **Type** drop-down list, select a built-in type.
- In the **Type** field, enter an expression that evaluates to a data type.

Additionally, in the Model Explorer, you can open the Data Type Assistant by clicking the **Show data type assistant** button . Specify a data **Mode**, and then specify the data type based on that mode. For more information, see “Specify Type of Stateflow Data” on page 9-27.

You can specify data type through a MATLAB expression that evaluates to a valid type specification. For more information, see “Derive Data Types from Other Data Objects” on page 9-30 and “Specify Data Properties by Using MATLAB Expressions” on page 9-16.

Note If you enter an expression for a fixed-point data type, you must specify scaling explicitly. For example, you cannot enter an incomplete specification such as `fixdt(1,16)` in the **Type** field. If you do not specify scaling explicitly, an error appears when you try to simulate your model.

Lock Data Type Against Fixed-Point Tools

Prevents replacement of the current fixed-point type with an autoscaled type chosen by the Fixed-Point Tool. For more information, see “Autoscaling Using the Fixed-Point Tool” (Fixed-Point Designer).

Unit (e.g., m, m/s², N*m)

Specifies physical units for input and output data. For more information, see “Specify Units for Stateflow Data” on page 25-17.

Initial Value

Initial value of the data object. The options for initializing values depend on the scope of the data object.

Scope	Specify for Initial Value
Local	Expression or parameter defined in the Stateflow hierarchy, MATLAB base workspace, or Simulink masked subsystem. When you leave this option blank, the local or output data resolves to a variable in the base workspace with the same name. When you choose Parameter the data is tunable. If you choose Expression the data is not tunable.
Constant	Constant value or expression. The expression is evaluated when you update the chart. The resulting value is used as a constant for running the chart.
Parameter	You cannot enter a value. The chart inherits the initial value from the parameter.

Scope	Specify for Initial Value
Input	You cannot enter a value. The chart inherits the initial value from the Simulink input signal on the designated port.
Output	Expression or parameter defined in the Stateflow hierarchy, MATLAB base workspace, or Simulink masked subsystem. When you leave this option blank, the local or output data resolves to a variable in the base workspace with the same name. When you choose Parameter the data is tunable. If you choose Expression the data is not tunable.
Data Store Memory	You cannot enter a value. The chart inherits the initial value from the Simulink data store to which it resolves.

If you do not specify a value, the default value for numeric data is 0. For enumerated data, the default value typically is the first one listed in the **enumeration** section of the definition. You can specify a different default enumerated value in the **methods** section of the definition. For more information, see “Define Enumerated Data Types” on page 20-5.

You can specify an initial value through a MATLAB expression. For more information, see “Specify Data Properties by Using MATLAB Expressions” on page 9-16.

Limit Range

Range of acceptable values for this data object. Stateflow charts use this range to validate the data object during simulation.

- **Minimum** — The smallest value allowed for the data item during simulation. You can enter an expression or parameter that evaluates to a numeric scalar value.
- **Maximum** — The largest value allowed for the data item during simulation. You can enter an expression or parameter that evaluates to a numeric scalar value.

The smallest value that you can set for **Minimum** is `-inf`. The largest value that you can set for **Maximum** is `inf`.

You can specify the minimum and maximum values through a MATLAB expression. For more information, see “Specify Data Properties by Using MATLAB Expressions” on page 9-16.

Note A Simulink model uses the **Limit range** properties to calculate best-precision scaling for fixed-point data types. Before you select **Calculate Best-Precision Scaling**, specify a minimum or maximum value. For more information, see “Calculate Best-Precision Scaling” on page 9-12.

Add to Watch Window

Enables watching the data values in the Stateflow Breakpoints and Watch window. For more information, see “View Data in the Breakpoints and Watch Window” on page 33-11.

Fixed-Point Data Properties

In the Model Explorer, when you set the Data Type Assistant **Mode** to **Fixed point**, the Data Type Assistant displays fields for specifying additional information about your fixed-point data.

The screenshot shows the 'Data data' dialog box with the following configuration:

- Name:** data
- Scope:** Local
- Data must resolve to signal object
- Size:** (empty)
- Complexity:** Off
- Type:** fixdt(1,16,2⁰,0)
- Data Type Assistant:**
 - Mode:** Fixed point
 - Signedness:** Signed
 - Word length:** 16
 - Scaling:** Slope and bias
 - Slope:** 2⁰
 - Bias:** 0
 - Data type override:** Inherit
 -
 - [+ Fixed-point details](#)
- Lock data type against Fixed-Point tools
- Initial value:** Expression
- Limit range:**
 - Minimum:** (empty)
 - Maximum:** (empty)
- [Add to Watch Window](#)
- Buttons:** OK, Cancel, Help, Apply

Signedness

Specifies whether the fixed-point data is Signed or Unsigned. Signed data can represent positive and negative values. Unsigned data represents positive values only. The default setting is Signed.

Word Length

Specifies the bit size of the word that holds the quantized integer. Large word sizes represent large values with greater precision than small word sizes. The default value is 16.

- Word length can be any integer from 0 through 128 for chart-level data of these scopes:
 - Input

- Output
- Parameter
- Data Store Memory
- For other Stateflow data, word length can be any integer from 0 through 32.

You can specify the word length through a MATLAB expression. For more information, see “Specify Data Properties by Using MATLAB Expressions” on page 9-16.

Scaling

Specifies the method for scaling your fixed-point data to avoid overflow conditions and minimize quantization errors. The default method is Binary point scaling.

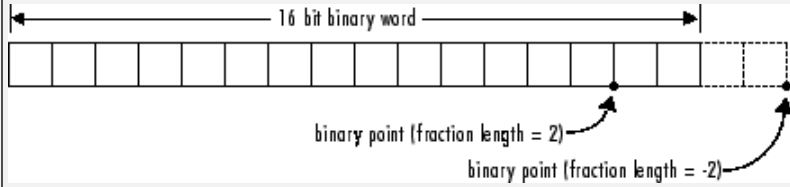
Setting	Description
Binary point	<p>If you select this mode, the Data Type Assistant displays the Fraction length field, which specifies the binary point location.</p> <p>Fraction length can be any integer. The default value is 0. A positive integer moves the binary point left of the rightmost bit by that amount. A negative integer moves the binary point farther right of the rightmost bit.</p>  <p>The diagram shows a horizontal row of 16 boxes representing bits. A double-headed arrow above the row is labeled "16 bit binary word". Two dots are placed below the row, each with an arrow pointing to a bit position. The first dot is labeled "binary point (fraction length = 2)" and points to the 14th bit from the left. The second dot is labeled "binary point (fraction length = -2)" and points to the 2nd bit from the right. A dashed line extends from the rightmost bit to the right, indicating the position of the rightmost bit.</p>
Slope and bias	<p>If you select this mode, the Data Type Assistant displays fields for entering the Slope and Bias for the fixed-point encoding scheme.</p> <p>Slope can be any positive real number. The default value is 1.0.</p> <p>Bias can be any real number. The default value is 0.0.</p> <p>You can enter slope and bias as expressions that contain parameters you define in the MATLAB base workspace.</p>

Whenever possible, use binary-point scaling to simplify the implementation of fixed-point data in generated code. Operations with fixed-point data that use binary-point scaling are performed with simple bit shifts and eliminate expensive code implementations required for separate slope and bias values. For more information about fixed-point scaling, see “Scaling” (Fixed-Point Designer).

You can specify **Fraction length**, **Slope**, and **Bias** through a MATLAB expression. For more information, see “Specify Data Properties by Using MATLAB Expressions” on page 9-16.

Data Type Override

Specifies whether to inherit the data type override setting of the Fixed-Point Tool that applies to this model. If the data does not inherit the model-wide setting, the specified data type applies.

Calculate Best-Precision Scaling

Specifies whether to calculate the best-precision values for **Binary point** and **Slope and bias** scaling, based on the values in the **Minimum** and **Maximum** fields in the **Limit range** section.

To calculate best-precision scaling values:

- 1 Specify **Limit range** properties.
- 2 Click **Calculate Best-Precision Scaling**.

The best-precision scaling values are displayed in the **Fraction length** field or the **Slope** and **Bias** fields. For more information, see “Maximize Precision” (Fixed-Point Designer).

Note The **Limit range** properties do not apply to **Constant** and **Parameter** scopes. For **Constant**, Simulink software calculates the scaling values based on the **Initial value** setting. The software cannot calculate best-precision scaling for data of **Parameter** scope.

Show Fixed-Point Details

Displays information about the fixed-point data type that is defined in the Data Type Assistant:

- **Minimum** and **Maximum** show the same values that appear in the corresponding **Minimum** and **Maximum** fields in the **Limit range** section.
- **Representable minimum**, **Representable maximum**, and **Precision** show the minimum value, maximum value, and precision that the fixed-point data type can represent.

If the value of a field cannot be determined without first compiling the model, the **Fixed-point details** subpane shows the value as **Unknown**.

The screenshot shows the 'Data data' dialog box with the 'General' tab selected. The dialog is titled 'Data data' and has a close button (X) in the top right corner. The 'General' tab contains the following fields and options:

- Name:** data
- Scope:** Local (dropdown menu)
- Data must resolve to signal object
- Size:** (empty text field)
- Complexity:** Off (dropdown menu)
- Type:** fixdt(1,16,0) (dropdown menu) with a '<<' button to the right.
- Data Type Assistant:**
 - Mode:** Fixed point (dropdown menu)
 - Signedness:** Signed (dropdown menu)
 - Word length:** 16 (text field)
 - Scaling:** Binary point (dropdown menu)
 - Fraction length:** 0 (text field)
 - Data type override:** Inherit (dropdown menu)
 - Calculate Best-Precision Scaling** (button)
 - [Fixed-point details](#)
 - Representable maximum: 32767
 - Maximum: 10000
 - Minimum: -20
 - Representable minimum: -32768
 - Precision: 1
 - Refresh Details** (button)
- Lock data type against Fixed-Point tools
- Initial value:** Expression (dropdown menu) with an empty text field to its right.
- Limit range:**
 - Minimum:** -20 (text field)
 - Maximum:** 10000 (text field)
- [Add to Watch Window](#) (link)

At the bottom of the dialog are four buttons: **OK**, **Cancel**, **Help**, and **Apply**.

The values displayed by the **Fixed-point details** subpane *do not* automatically update if you change the values that define the fixed-point data type. To update the values shown in the **Fixed-point details** subpane, click **Refresh Details**.

Clicking **Refresh Details** does not modify the model. It changes only the display. To apply the displayed values, click **Apply** or **OK**.

The **Fixed-point details** subpane indicates any error resulting from the fixed-point data type specification. For example, this figure shows two errors.

The screenshot shows the 'Data data' dialog box with the 'General' tab selected. The 'Name' is 'data', 'Scope' is 'Local', and 'Complexity' is 'Off'. The 'Type' is 'fixdt(1,16,0)'. The 'Data Type Assistant' section shows 'Mode' as 'Fixed point', 'Signedness' as 'Signed', 'Word length' as '16', 'Scaling' as 'Binary point', and 'Fraction length' as '0'. The 'Fixed-point details' section is expanded, showing the following information:

Representable maximum:	32767	
Maximum:	50000	Outside representable range by 17233 (17233 x precision)
Minimum:	MySymbol	Cannot evaluate
Representable minimum:	-32768	

The 'Precision' is 1. There are two yellow warning icons next to the 'Maximum' and 'Minimum' rows. A 'Refresh Details' button is located at the bottom right of the 'Fixed-point details' section. Below this section, there is a 'Limit range' section with 'Minimum' set to 'MySymbol' and 'Maximum' set to '50000'. At the bottom of the dialog are 'OK', 'Cancel', 'Help', and 'Apply' buttons.

The row labeled **Maximum** indicates that the value specified in the **Maximum** field of the **Limit range** section is not representable by the fixed-point data type. To correct the error, make one of these modifications so the fixed-point data type can represent the maximum value:

- Decrease the value in the **Maximum** field of the **Limit range** section.
- Increase **Word length**.
- Decrease **Fraction length**.

The row labeled **Minimum** shows the error `Cannot evaluate` because evaluating the expression `MySymbol`, specified in the **Minimum** field of the **Limit range** section, does not return a numeric value. When an expression does not evaluate successfully, the **Fixed-point details** subpane shows the unevaluated expression (truncating to 10 characters as needed) in place of the unavailable value. To correct this error, define `MySymbol` in the base workspace to provide a numeric value. If you click **Refresh Details**, the error indicator and description are removed and the value of `MySymbol` appears in place of the unevaluated text.

Logging Properties

You can set logging properties for data in:

- The **Logging** section of the Property Inspector.
- The **Logging** tab of the Model Explorer.

Log Signal Data

Saves the data value to the MATLAB base workspace during simulation. For more information, see “Log Simulation Output for States and Data” on page 33-45.

Test Point

Designates the data as a test point. A test point is a signal that you can observe in a Floating Scope block in a model. Data objects can be test points if:

- Scope is `Local`.
- Parent is not a Stateflow machine.
- Data type is not `ml`.

For more information, see “Monitor Test Points in Stateflow Charts” on page 33-41.

Logging Name

Specifies the name associated with logged signal data. Simulink software uses the signal name as its logging name by default. To specify a custom logging name, select `Custom` from the list box and enter the new name in the adjacent edit field.

Limit Data Points to Last

Limits the amount of data logged to the most recent samples.

Decimation

Limits the amount of data logged by skipping samples. For example, a decimation factor of 2 saves every other sample.

Additional Properties

You can set additional data properties in:

- The **Info** tab of the Property Inspector.
- The **Description** tab of the Model Explorer.

Save Final Value to Base Workspace

Assigns the value of the data object to a variable of the same name in the MATLAB base workspace at the end of simulation. This option is available only in the Model Explorer for C charts. For more information, see “Model Workspaces” (Simulink).

Units

Units of measurement associated with the data object. The unit in this field resides with the data object in the Stateflow hierarchy. This property is available only in the Model Explorer for C charts.

Description

Description of the data object. You can enter brief descriptions of data in the hierarchy.

Document Link

Link to online documentation for the data object. You can enter a web URL address or a MATLAB command that displays documentation in a suitable online format, such as an HTML file or text in the MATLAB Command Window. When you click the **Document link** hyperlink, Stateflow evaluates the link and displays the documentation.

Default Data Property Values

When you leave a property field blank, Stateflow assumes a default value.

Property		Default Value
“Size” on page 9-7		-1 (inherited), for inputs, parameters, and function outputs 1 (scalar), for other data objects
“First Index” on page 9-8		0
“Initial Value” on page 9-8		0.0
“Limit Range” on page 9-9	Minimum	-inf
	Maximum	inf
“Fixed-Point Data Properties” on page 9-9	Word length	16
	Fraction length	0
	Slope	1.0
	Bias	0.0

Specify Data Properties by Using MATLAB Expressions

In the Property Inspector and Model Explorer, you can enter MATLAB expressions as values for these properties:

- “Size” on page 9-7
- “Type” on page 9-8
- “Initial Value” on page 9-8
- “Limit Range” on page 9-9
 - **Minimum**
 - **Maximum**
- “Fixed-Point Data Properties” on page 9-9
 - **Word length**
 - **Fraction length**
 - **Slope**
 - **Bias**
- “Size” on page 9-7
- “Type” on page 9-8
- “Initial Value” on page 9-8
- “Limit Range” on page 9-9: **Minimum** and **Maximum**
- “Fixed-Point Data Properties” on page 9-9: **Word length**, **Fraction length**, **Slope**, and **Bias**

Expressions can contain a mix of numeric values, constants, parameters, variables, arithmetic operations, parameters, constants, arithmetic operators, and calls to MATLAB functions. For example, you can use these functions to specify data properties.

Property	Function	Description
Size	size	Returns the size of a data object
	fi	Returns a fixed-point numeric object
Type	type on page 13-17	Returns the type of a data object
	fixdt	Returns a Simulink.NumericType object that describes a fixed-point or floating-point data type
Minimum	min	Returns the smallest element or elements of an array
Maximum	max	Returns the largest element or elements of an array

For more information, see “Specify Data Size by Using Expressions” on page 9-34 and “Derive Data Types from Other Data Objects” on page 9-30.

See Also

fi | fixdt | max | min | size

More About

- “Add Stateflow Data” on page 9-2
- “Rules for Naming Stateflow Objects” on page 2-5
- “Specify Type of Stateflow Data” on page 9-27

- “Specify Size of Stateflow Data” on page 9-33

Share Data with Simulink and the MATLAB Workspace

Stateflow charts interface with the other blocks in a Simulink model by:

- Sharing data through input and output connections.
- Importing initial data values from the MATLAB base workspace.
- Saving final data values to the MATLAB base workspace.

Charts also can access Simulink parameters and data stores. For more information, see “Share Parameters with Simulink and the MATLAB Workspace” on page 9-21 and “Access Data Store Memory from a Chart” on page 9-23.

Share Input and Output Data with Simulink

Data flows from Simulink into a Stateflow chart through input ports. Data flows from a Stateflow chart into Simulink through output ports.

To define input or output data in a chart:

- 1 Add a data object to the chart, as described in “Add Stateflow Data” on page 9-2.
- 2 Set the **Scope** property for the data object.
 - To define input data, set **Scope** to **Input Data**. An input port appears on the left side of the chart block.
 - To define output data, set **Scope** to **Output Data**. An output port appears on the right side of the chart block.

By default, **Port** values appear in the order in which you add data objects. You can change these assignments by modifying the **Port** property of the data. When you change the **Port** property for an input or output data object, the **Port** values for the remaining input or output data objects automatically renumber.

- 3 Set the data type of the data object, as described in “Specify Type of Stateflow Data” on page 9-27.
- 4 Set the size of the data object, as described in “Specify Size of Stateflow Data” on page 9-33.

Note You cannot set the type or size of Stateflow input data to accept frame-based data from Simulink.

Initialize Data from the MATLAB Base Workspace

You can import the initial value of a data symbol by defining it in the MATLAB base workspace and in the Stateflow hierarchy.

- 1 Define and initialize a variable in the MATLAB base workspace.
- 2 In the Stateflow hierarchy, define a data object with the same name as the MATLAB variable.
- 3 Select the **Allow initial value to resolve to a parameter** property for the data object.

When the simulation starts, data resolution occurs. During this process, the Stateflow data object gets its initial value from the associated MATLAB variable.

One-dimensional Stateflow arrays are compatible with MATLAB row and column vectors of the same size. For example, a Stateflow vector of size 5 is compatible with a MATLAB row vector of size [1, 5] or column vector of size [5, 1]. Each element of the Stateflow array initializes to the same value as the corresponding element of the array in the MATLAB base workspace.

The time of initialization depends on the data parent and scope of the Stateflow data object.

Data Parent	Scope	Initialization Time
Machine	Local, Exported	Start of simulation
	Imported	Not applicable
Chart	Input	Not applicable
	Output, Local	Start of simulation or when chart reinitializes as part of an enabled Simulink subsystem
State with History Junction	Local	Start of simulation or when chart reinitializes as part of an enabled Simulink subsystem
State without History Junction	Local	State activation
Function (graphical, truth table, and MATLAB functions)	Input, Output	Function-call invocation
	Local	Start of simulation or when chart reinitializes as part of an enabled Simulink subsystem

Save Data to the MATLAB Base Workspace

At the end of simulation, a Stateflow chart that uses C as the action language can save the final value of a data object to the MATLAB base workspace.

- 1 Open the Model Explorer. In the **Modeling** tab, select **Model Explorer**.
- 2 Double-click the data object in the **Contents** pane.
- 3 In the **Description** pane of the Data properties dialog box, select **Save final value to base workspace**.

This option is available for data symbols of all scopes except Constant and Parameter.

See Also

More About

- “Add Stateflow Data” on page 9-2
- “Set Data Properties” on page 9-5
- “Share Parameters with Simulink and the MATLAB Workspace” on page 9-21
- “Access Data Store Memory from a Chart” on page 9-23

Share Parameters with Simulink and the MATLAB Workspace

A parameter is a constant data object that you can:

- Define in the MATLAB base workspace.
- Derive from a Simulink block parameter that you define and initialize in a mask.

Use parameters to avoid hard-coding data values and properties. Share Simulink parameters with charts to maintain consistency with your Simulink model.

You can access parameter values in multiple Stateflow objects in a chart such as states, MATLAB functions, and truth tables. You can include parameters in expressions defining data properties such as:

- Size
- Type
- Initial Value
- Minimum and Maximum
- Fixed-Point Data Properties

For more information, see “Specify Data Properties by Using MATLAB Expressions” on page 9-16

Initialize Parameters from the MATLAB Base Workspace

You can initialize a parameter by defining it in the MATLAB base workspace and in the Stateflow hierarchy.

- 1 Define and initialize a variable in the MATLAB base workspace.
- 2 In the Stateflow hierarchy, define a data object with the same name as the MATLAB variable.
- 3 Set the scope of the Stateflow data object to **Parameter**.

When the simulation starts, data resolution occurs. During this process, the Stateflow parameter gets its value from the associated MATLAB variable.

Share Simulink Parameters with Charts

You can share a parameter from a Simulink subsystem containing a Stateflow chart by creating a mask for the subsystem.

- 1 In the Simulink mask editor for the parent subsystem, define and initialize a Simulink parameter.
- 2 In the Stateflow hierarchy, define a data object with the same name as the Simulink parameter.
- 3 Set the scope of the Stateflow data object to **Parameter**.

When the simulation starts, Simulink tries to resolve the Stateflow data object to a parameter at the lowest-level masked subsystem. If unsuccessful, Simulink moves up the model hierarchy to resolve the data object to a parameter at higher-level masked subsystems.

See Also

More About

- “Create a Mask to Share Parameters with Simulink” on page 25-14
- “Add Stateflow Data” on page 9-2
- “Set Data Properties” on page 9-5

Access Data Store Memory from a Chart

A Simulink model implements global variables as data stores, either as Data Store Memory blocks or as instances of Simulink.Signal objects. You can use data stores to share data between multiple Simulink blocks without explicit input or output connections to pass data from one block to another. Stateflow charts share global data with Simulink models by reading from and writing to data store memory symbolically.

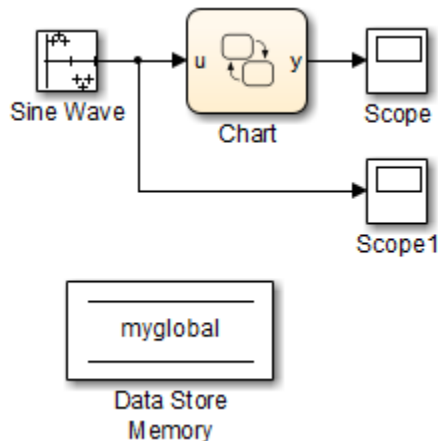

To access global data from a chart, bind a Stateflow data object to a Simulink data store. After you create the binding, the Stateflow data object becomes a symbolic representation of the Simulink data store memory. You can then use this symbolic object to store and retrieve global data.

Local and Global Data Store Memory

Stateflow charts can interface with local and global data stores.

- Local data stores are visible to all blocks in one model. To interact with a local data store, a chart must reside in the model where you define the local data store. You can define a local data store by adding a Data Store Memory block to a model or by creating a Simulink signal object.
- Global data stores have a broader scope that crosses model reference boundaries. To interact with global data stores, a chart must reside in the top model where you define the global data store or in a model that the top model references. You implement global data stores as Simulink signal objects.

For more information, see “Local and Global Data Stores” (Simulink).

Bind Stateflow Data to Data Stores

- 1 To define the Simulink data store memory, add a Data Store Memory block to your model or create a Simulink signal object. For more information, see “Data Stores with Data Store Memory Blocks” (Simulink) and “Data Stores with Signal Objects” (Simulink).
- 2 Add a data object to the Stateflow chart, as described in “Add Stateflow Data” on page 9-2.
- 3 Set the **Name** property as the name of the Simulink data store memory to which you want to bind the Stateflow data object.

4 Set the **Scope** property to Data Store Memory.

The Stateflow data object inherits all additional properties from the data store memory to which you bind the object.

Multiple local and global data stores with the same name can exist in the same model hierarchy. In this situation, the Stateflow data object binds to the data store that is the nearest ancestor.

Store and Retrieve Global Data

After binding a Stateflow data object to a Simulink data store, you can store and retrieve global data in state and transition actions. The data object acts as a global variable that you reference by its symbolic name. When you store numeric values in this variable, you are writing to the Simulink data store memory. When you retrieve numeric values from this variable, you are reading from the data store memory.

For example, in this chart, the state actions read from and write to a Data Store Memory block called `myglobal`.

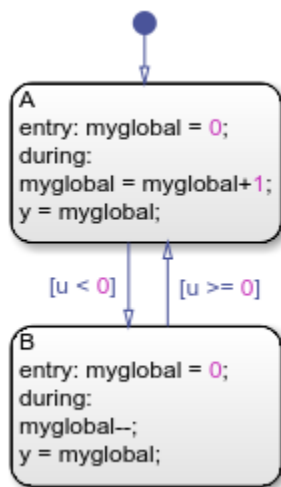

Best Practices for Using Data Stores

Data Store Properties in Charts

When you bind a Stateflow data object to a data store, the Stateflow object inherits all of its properties from the data store. To ensure that properties propagate correctly, when you create the Simulink data stores:

- Specify a data type other than `auto`.
- Minimize the use of automatic-mode properties.

Share Data Store Memory Across Multiple Models

To access a global data store from multiple models:

- Verify that your models do not contain any Data Store Memory blocks. You can include Data Store Read and Data Store Write blocks.

- In the MATLAB base workspace, create a `Simulink.Signal` object with these attributes:
 - Set **Data type** to an explicit data type. The data type cannot be `Auto`.
 - Fully specify **Dimensions**. The signal dimensions cannot be `-1` or `Inherited`.
 - Fully specify **Complexity**. The complexity cannot be `Auto`.
 - Set **Storage class** to `ExportedGlobal`.
- In each chart that shares the data, bind a Stateflow data object to the Simulink data store.

Write to Data Store Memory Before Reading

To avoid algorithm latency, write to data store memory before reading from it. Otherwise, the read actions retrieve the value that was stored in the previous time step, rather than the value computed and stored in the current time step. When unconnected blocks share global data while running at different rates:

- Segregate read actions into separate blocks from write actions.
- Assign priorities to blocks so that your model invokes write blocks before read blocks. For more information, see “Control and Display Execution Order” (Simulink).

To avoid situations when multiple reads and writes occur unintentionally in the same time step, enable the Data Store Memory block diagnostics to:

- **Detect Read Before Write**
- **Detect Write After Read**
- **Detect Write After Write**

If you use a data store memory block as a persistent global storage area for accumulating values across time steps, avoid unnecessary warnings by disabling the Data Store Memory block diagnostics. For more information, see “Data Store Diagnostics” (Simulink).

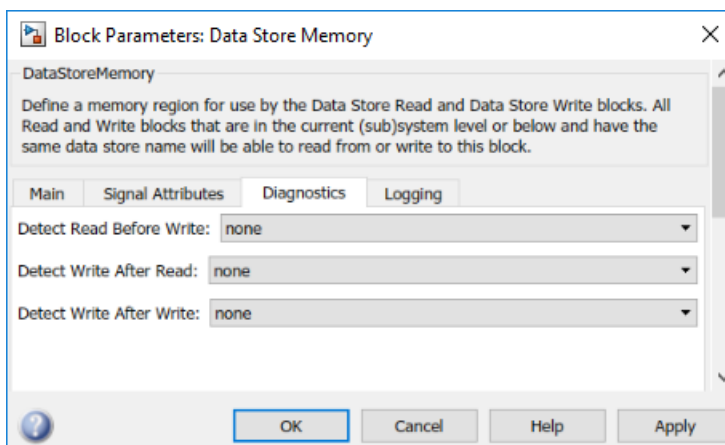

See Also

Data Store Read | Data Store Write | Data Store Memory | `Simulink.Signal`

More About

- “Add Stateflow Data” on page 9-2

- [“Data Store Basics” \(Simulink\)](#)
- [“Model Global Data by Creating Data Stores” \(Simulink\)](#)
- [“Data Store Diagnostics” \(Simulink\)](#)
- [“Control and Display Execution Order” \(Simulink\)](#)

Specify Type of Stateflow Data

The term data type refers to how computers represent information in memory. The data type determines the amount of storage allocated to data, the method of encoding a data value as a pattern of binary digits, and the operations available for manipulating the data.

Specify Data Type by Using the Data Type Assistant

You can specify the type of a data object in either the Property Inspector or the Model Explorer. In the **Type** field, select a type from the drop-down list or enter an expression that evaluates to a data type. For more information, see “Set Data Properties” on page 9-5.

Alternatively, use the Data Type Assistant to specify a data **Mode** and select the data type based on that mode:

- 1 In the Model Explorer, on the **Data** pane, click the **Show data type assistant** button .
- 2 Select a **Mode** from the drop-down list. The list of available modes depends on the scope of the data object.

Scope	Modes
Local	Inherit (available only in charts that use MATLAB as the action language), Built in, Fixed point, Enumerated, Bus object, Expression
Constant	Built in, Fixed point, Expression
Parameter	Inherit, Built in, Fixed point, Enumerated, Bus object, Expression
Input	Inherit, Built in, Fixed point, Enumerated, Bus object, Expression
Output	Inherit, Built in, Fixed point, Enumerated, Bus object, Expression
Data Store Memory	Inherit

- 3 Specify additional information based on the mode. The Data Type Assistant populates the **Type** field based on your specification.

Mode	Data Types
Inherit	<p>You cannot specify a data type. You inherit the data type based on the scope that you select for the data object:</p> <ul style="list-style-type: none"> • For charts that use MATLAB as the action language, if scope is <code>Local</code>, the data infers its type from the context of the MATLAB code in the chart. • If the scope is <code>Parameter</code>, the data inherits its type from the associated parameter, which you can define in the Simulink model or in the MATLAB base workspace. See “Share Parameters with Simulink and the MATLAB Workspace” on page 9-21. • If the scope is <code>Input</code>, the data inherits its type from the Simulink input signal on the designated input port. See “Share Input and Output Data with Simulink” on page 9-19. • If the scope is <code>Output</code>, the data inherits its type from the Simulink output signal on the designated output port. See “Share Input and Output Data with Simulink” on page 9-19. <hr/> <p>Note Avoid inheriting data types from output signals. See “Avoid Inheriting Output Data Properties from Simulink Blocks” on page 9-3.</p> <ul style="list-style-type: none"> • If the scope is <code>Data Store Memory</code>, the data inherits its type from the Simulink data store to which you bind the data object. See “Access Data Store Memory from a Chart” on page 9-23. <p>For more information, see “Inherit Data Types from Simulink Objects” on page 9-30.</p>

Mode	Data Types
Built in	<p>Specify a data type from the drop-down list of supported data types:</p> <ul style="list-style-type: none"> • double: 64-bit double-precision floating point. • single: 32-bit single-precision floating point. • int64: 64-bit signed integer. int64 is a type alias for the fixed-point type <code>fixdt(1,64,0)</code>. • int32: 32-bit signed integer. • int16: 16-bit signed integer. • int8: 8-bit signed integer. • uint64: 64-bit unsigned integer. uint64 is a type alias for the fixed-point type <code>fixdt(0,64,0)</code>. • uint32: 32-bit unsigned integer. • uint16: 16-bit unsigned integer. • uint8: 8-bit unsigned integer. • boolean: Boolean (1 = true; 0 = false). • ml: Typed internally with the MATLAB array <code>mxArray</code>. The ml data type provides Stateflow data with the benefits of the MATLAB environment, including the ability to assign the Stateflow data object to a MATLAB variable or pass it as an argument to a MATLAB function. ml data cannot have a scope outside the Stateflow hierarchy. That is, it cannot have a scope of Input or Output. For more information, see “ml Data Type” on page 13-31. • string: String. Supported only in charts that use C as the action language. For more information, see “Manage Textual Information by Using Strings” on page 21-2.
Fixed point	<p>Specify this information about the fixed-point data:</p> <ul style="list-style-type: none"> • Signedness: Whether the data is signed or unsigned • Word Length: Bit size of the word that holds the quantized integer. Large word sizes represent large values with greater precision than small word sizes. The default value is 16. • Scaling: Method for scaling your fixed-point data to avoid overflow conditions and minimize quantization errors. The default method is Binary point. <p>For information, see “Fixed-Point Data Properties” on page 9-9.</p>
Enumerated	<p>Specify the class name for the enumerated data type. For more information, see “Define Enumerated Data Types” on page 20-5.</p>
Bus object	<p>Specify the name of a <code>Simulink.Bus</code> object to associate with the Stateflow bus object structure. Click Edit to create or edit a bus object in the Bus Editor. You can also inherit bus object properties from Simulink signals.</p>

Mode	Data Types
Expression	<p>Specify an expression that evaluates to a data type. You can use one of these expressions:</p> <ul style="list-style-type: none"> • An alias type from the MATLAB base workspace, as described in “Specify Data Types by Using a Simulink Alias” on page 9-31. • <code>type</code> operator to specify the type of previously defined data, as described in “Derive Data Types from Other Data Objects” on page 9-30. • <code>fixdt</code> function to create a <code>Simulink.NumericType</code> object that describes a fixed-point or floating-point data type. <p>For more information, see “Specify Data Properties by Using MATLAB Expressions” on page 9-16.</p>

- 4 To save the data type settings, click **Apply**.

The Data Type Assistant is available only through the Model Explorer.

Inherit Data Types from Simulink Objects

When you select `Inherit: Same as Simulink` from the **Type** drop-down list, data objects of scope `Input`, `Output`, `Parameter`, and `Data Store Memory` inherit their data types from Simulink objects.

Scope	Description
Input	Inherits type from the Simulink input signal connected to corresponding input port in chart.
Output	Inherits type from the Simulink output signal connected to corresponding output port in chart. Avoid inheriting data types from output signals. Values that back-propagate from Simulink blocks can be unpredictable.
Parameter	Inherits type from the corresponding MATLAB base workspace variable or Simulink parameter in a masked subsystem.
Data Store Memory	Inherits type from the corresponding Simulink data store.

To determine the data types that the objects inherit:

- 1 Build the Simulink model.
- 2 Open the Model Explorer.
- 3 In the **Contents** pane, examine the **CompiledType** column.

Derive Data Types from Other Data Objects

You can use the `type` operator to derive data types from other Stateflow data objects:

```
type(data_obj)
```

For example, in the model `sf_bus_demo`, the expression `type(inbus)` returns the data type of the input structure `inbus`. Because `inbus` derives its type from the `Simulink.Bus` object `COUNTERBUS`,

the data type of the local structure `counterbus_struct` also derives its data type from `COUNTERBUS`.

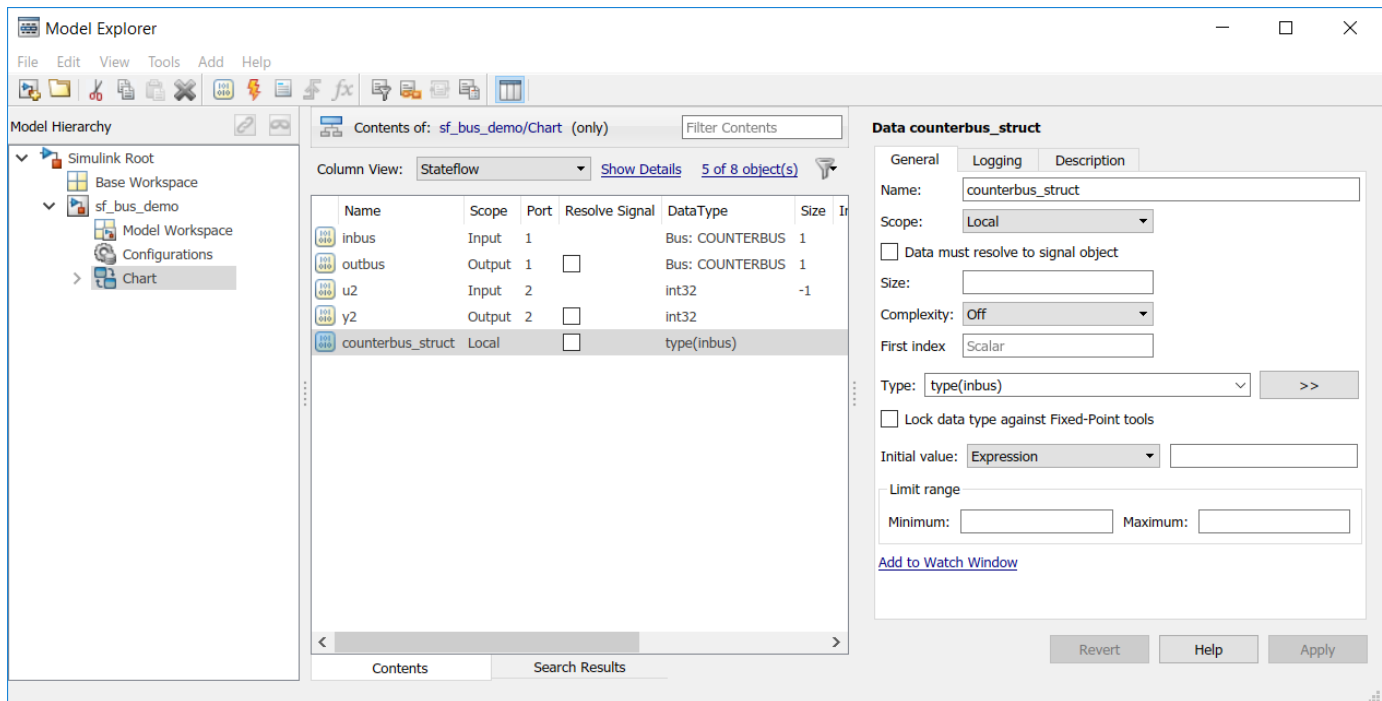

After you build your model, the **CompiledType** column of the Model Explorer shows the type used in the compiled simulation application.

Specify Data Types by Using a Simulink Alias

You can specify the type of Stateflow data by using a Simulink data type alias. For more information, see `Simulink.AliasType`.

For example, suppose that you want to define a data type alias `MyFloat` that corresponds to the built-in data type `single`. At the MATLAB command prompt, enter:

```
MyFloat = Simulink.AliasType;
MyFloat.BaseType = 'single';
```

To use this alias to specify the type of a data object, select the object in the Property Inspector or the Model Explorer. In the **Type** field, enter the alias name `MyFloat`.

After you build your model, the **CompiledType** column of the Model Explorer shows the type used in the compiled simulation application.

Strong Data Typing with Simulink Inputs and Outputs

By default, the **Use Strong Data Typing with Simulink I/O** chart property allows C charts to interface directly with signals from Simulink models. The chart accepts only input signals whose data type matches the type of the corresponding Stateflow data object. Otherwise, a type mismatch error occurs. For example, by selecting **Use Strong Data Typing with Simulink I/O**, you can flag

mismatches between input or output fixed-point data in charts and their counterparts in Simulink models. For more information, see “Specify Properties for Stateflow Charts” on page 25-2.

If you clear the **Use Strong Data Typing with Simulink I/O** chart property, the chart converts inputs signals of type `double` to the type of the corresponding input data object in the chart. The chart converts output data objects to type `double` before exporting them as output signals to Simulink models.

Note The **Use Strong Data Typing with Simulink I/O** chart property is provided for backward compatibility. Clearing this check box can produce unpredictable results and is not recommended.

See Also

More About

- “Set Data Properties” on page 9-5
- “Specify Properties for Stateflow Charts” on page 25-2
- “About Data Types in Simulink” (Simulink)

Specify Size of Stateflow Data

In a Stateflow chart in a Simulink model, you specify the size of a data object by:

- Setting the **Size** property, as described in “Set Data Properties” on page 9-5. For more information, see “Size” on page 9-7.
- Setting the `Props.Array.Size` property through the Stateflow API. For more information, see “Stateflow.Data”.

Use one of these methods to specify the size:

- Inherit the size from a Simulink signal or from its definition in the Stateflow chart.
- Enter a numeric value.
- Enter a MATLAB expression.

Support for each sizing method depends on the scope of your data.

Scope of Data	Method for Sizing Data		
	Inherit the Size	Use Numeric Values	Use MATLAB Expressions
Local	Only in charts that use MATLAB as the action language	Yes	Yes
Constant	No	Yes	Yes
Parameter	Yes	Yes	Yes
Input	Yes	Yes	Yes
Output	Yes	Yes	Yes
Data store memory	Yes	No	No

Inherit Data Size

To configure a Stateflow data object to inherit its size from the corresponding Simulink signal or its definition in the chart, specify a size of `-1`. After you simulate or build your model, you can find the inherited size of the data in the Model Explorer, under the **Compiled Size** column.

Note Charts cannot inherit data sizes from Simulink frame-based signals. For more information, see “Sample- and Frame-Based Concepts” (DSP System Toolbox).

Specify Data Size by Using Numeric Values

When you specify data size by entering a numeric value, follow these guidelines:

- To specify a scalar, enter 1 or leave the field blank.
- To specify an n -by-1 column vector, enter n .
- To specify a 1-by- n row vector, enter $[1 \ n]$.
- To specify an n -by- m matrix, enter $[n \ m]$.

- To specify an n -dimensional array, enter $[d_1 \ d_2 \ \dots \ d_n]$, where d_i is the size of the i^{th} dimension.

In charts that use C as the action language, one-dimensional Stateflow vectors are compatible with Simulink row or column vectors of the same size. For example, a Stateflow input data of size 3 is compatible with a Simulink row vector of size $[1 \ 3]$ or a column vector of size $[3 \ 1]$.

Specify Data Size by Using Expressions

You can specify data size by entering a MATLAB expression that evaluates to one of the size specifications described in “Specify Data Size by Using Numeric Values” on page 9-33. These guidelines also apply:

- Expressions can contain a mix of numeric values, constants, parameters, variables, arithmetic operations, and calls to MATLAB functions.
- Expressions that specify the size of a dimension must evaluate to a positive integer value.
- If the expression contains an enumerated value, you must include the type prefix for consistency with MATLAB naming rules. For example, `Colors.Red` is valid but `Red` is not. For more information, see “Notation for Enumerated Values” on page 20-3.
- You cannot use a MATLAB expression to:
 - Specify inherited data size. Do not use expressions that evaluate to `-1`.
 - Specify the size of Stateflow input data that accepts frame-based data from Simulink. For more information, see “Sample- and Frame-Based Concepts” (DSP System Toolbox).

Examples of Valid Data Size Expressions

These examples are valid MATLAB expressions for specifying data size in your chart:

- `K+3`, where `K` is a chart-level Stateflow constant or parameter.
- `N/2`, where `N` is a variable in the MATLAB base workspace.
- `[P Q]`, where `P` and `Q` are Simulink parameters. Charts that use C as the action language propagate these symbolic dimensions throughout the model. See “Propagate Symbolic Dimensions of Stateflow Data” on page 9-35.
- `2*Colors.Red`, where `Red` is an enumerated value of type `Colors`.
- `size(u)`, where `u` is a chart-level variable. The function `size` enables you to specify the size of one data object based on the size of another data object. This type of expression is useful in a library chart that you reuse with data of different sizes. In other situations, you can improve the clarity of your chart by avoiding the `size` function and specifying the size of the data directly.
- `[fi(2,1,16,2) fi(4,1,16,2)]`. This expression specifies a data size of $[2 \ 4]$ by calling the function `fi`. This function returns signed fixed-point numbers with a word length of 16 and a fraction length of 2.

Avoid Variables That Can Lead to Naming Conflicts

When a model contains multiple variables with identical names, the variable with the highest priority is used to specify size.

Priority	Variable
1	Mask parameter

Priority	Variable
2	Model workspace variable
3	MATLAB base workspace variable
4	Stateflow data

To avoid confusion, do not specify data size by using a variable name that you define in multiple levels of your model.

Propagate Symbolic Dimensions of Stateflow Data

When you select the model configuration parameter **Allow symbolic dimension specification**, charts that use C as the action language can propagate the symbolic dimensions of Stateflow data throughout the model. If you have Embedded Coder, the symbolic dimensions go into the generated code for ERT targets. Specify the size of the symbolic dimensions by using Simulink parameters with one of these storage classes:

- `Define` or `ImportedDefine` with a specified header file
- `CompilerFlag`
- A user-defined custom storage class that defines data as a macro in a specified header file

For more information, see “Allow symbolic dimension specification” (Simulink) and “Implement Dimension Variants for Array Sizes in Generated Code” (Embedded Coder).

Stateflow charts that use MATLAB as the action language do not support symbolic dimension propagation. To specify data size by using Simulink parameters, clear the **Allow symbolic dimension specification** check box.

See Also

`fi` | `size`

More About

- “Vectors and Matrices in Stateflow Charts” on page 18-2
- “Stateflow Data Properties” on page 9-5
- “Properties and Methods Sorted by Stateflow Object”
- “Reference Values by Name by Using Enumerated Data” on page 20-2

Handle Integer Overflow for Chart Data

When Integer Overflow Can Occur

For some arithmetic operations, a processor may need to take an n -bit fixed-point value and store it in m bits, where $m \neq n$. If $m < n$, the reduced range of the value can cause an overflow for an arithmetic operation. Some processors identify this overflow as Inf or NaN. Other processors, especially digital signal processors (DSPs), handle overflows by saturating or wrapping the value.

For more information about saturation and wrapping for integer overflow, see “Saturation and Wrapping” (Fixed-Point Designer).

Support for Handling Integer Overflow in Charts

For Stateflow charts in Simulink models, you can control whether or not saturation occurs for integer overflow. Use the chart property, **Saturate on integer overflow**, to control overflow handling.

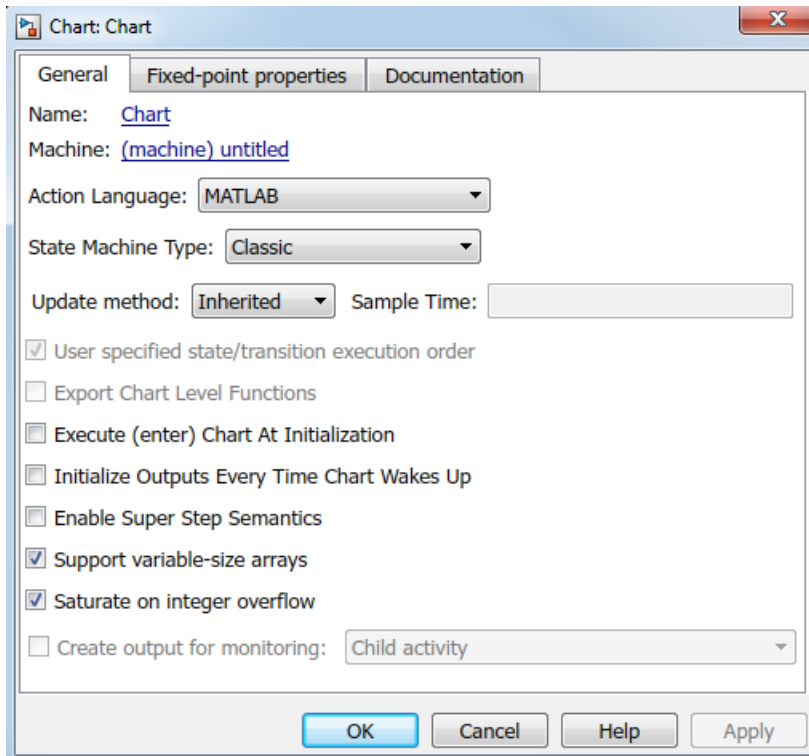

Check Box	When to Use This Setting	Overflow Handling	Example of the Result
Selected	Overflow is possible for data in your chart and you want explicit saturation protection in the generated code.	Overflows saturate to either the minimum or maximum value that the data type can represent.	An overflow associated with a signed 8-bit integer saturates to -128 or +127 in the generated code.

Check Box	When to Use This Setting	Overflow Handling	Example of the Result
Cleared	You want to optimize efficiency of the generated code.	The handling of overflows depends on the C compiler that you use for generating code.	The number 130 does not fit in a signed 8-bit integer and wraps to -126 in the generated code.

Arithmetic operations for which you can enable saturation protection are:

- Unary minus: `-a`
- Binary operations: `a + b`, `a - b`, `a * b`, `a / b`, `a ^ b`
- Assignment operations: `a += b`, `a -= b`, `a *= b`, `a /= b`
- In C charts, increment and decrement operations: `++`, `--`

When you select **Saturate on integer overflow**, be aware that:

- Saturation applies to all intermediate operations, not just the output or final result.
- The code generator can detect some cases when overflow is not possible. In these cases, the generated code does not include saturation protection.

To determine whether clearing the **Saturate on integer overflow** check box is a safe option, perform a careful analysis of your logic, including simulation if necessary. If saturation is necessary in only some sections of the logic, encapsulate that logic in atomic subcharts or MATLAB functions and define a different set of saturation settings for those units.

Effect of Integer Promotion Rules on Saturation

Charts use ANSI[®] C rules for integer promotion.

- All arithmetic operations use a data type that has the same word length as the target word size. Therefore, the intermediate data type in a chained arithmetic operation can be different from the data type of the operands or the final result.
- For operands with integer types smaller than the target word size, promotion to a larger type of the same word length as the target size occurs. This implicit cast occurs before any arithmetic operations take place.

For example, when the target word size is 32 bits, an implicit cast to `int32` occurs for operands with a type of `uint8`, `uint16`, `int8`, or `int16` before any arithmetic operations occur.

Suppose that you have the following expression, where `y`, `u1`, `u2`, and `u3` are of `uint8` type:

```
y = (u1 + u2) - u3;
```

Based on integer promotion rules, that expression is equivalent to the following statements:

```
uint8_T u1, u2, u3, y;
int32_T tmp, result;
tmp = (int32_T) u1 + (int32_T) u2;
result = tmp - (int32_T) u3;
y = (uint8_T) result;
```

For each calculation, the following data types and saturation limits apply.

Calculation	Data Type	Saturation Limits
tmp	int32	(MIN_INT32, MAX_INT32)
result	int32	(MIN_INT32, MAX_INT32)
y	uint8	(MIN_UINT8, MAX_UINT8)

Suppose that u1, u2, and u3 are equal to 200. Because the saturation limits depend on the intermediate data types and not the operand types, you get the following values:

- tmp is 400.
- result is 200.
- y is 200.

Impact of Saturation on Error Checks

Suppose that you set **Wrap on overflow** in the **Diagnostics: Data Validity** pane of the Model Configuration Parameters dialog box to error or warning. When you select **Saturate on integer overflow**, Stateflow does not flag cases of integer overflow during simulation. However, Stateflow continues to flag the following situations:

- Out-of-range data violations based on minimum and maximum range checks
- Division-by-zero operations

Identify Data by Using Dot Notation

To specify the path from the parent state to a data object, a qualified data name uses dot notation. Dot notation is a way to identify data at a specific level of the Stateflow chart hierarchy. The first part of a qualified data name identifies the parent object. Subsequent parts identify the children along a hierarchical path.

For example, in this chart, the symbol `data` resides in the substate `aa` of the state `a`. The state and transition actions use qualified data names to refer to this symbol.

- In the default transition, the action uses the qualified data name `a.aa.data` to specify a path from the chart to the top-level state `a`, to the substate `aa`, and finally to `data`.
- In state `a`, the entry action uses the qualified data name `aa.data` to specify a path from the substate `aa` to `data`.
- In state `b`, the entry action uses the qualified data name `a.aa.data` to specify a path from the chart to the state `a`, to the substate `aa`, and then to `data`.

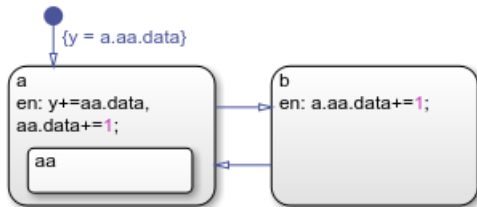

Resolution of Qualified Data Names

During simulation, Stateflow resolves the qualified data name by performing a localized search of the chart hierarchy for a matching data object. The search begins at the hierarchy level where the qualified data name appears:

- For a state action, the starting point is the state containing the action.
- For a transition label, the starting point is the parent of the transition source.

The resolution process searches each level of the chart hierarchy for a path to the data. If a data object matches the path, the process adds that data object to the list of possible matches. Then, the process continues the search one level higher in the hierarchy. The resolution process stops after it searches the chart level of the hierarchy. If a unique match exists, the qualified data name resolves to the matching path. Otherwise, the resolution process fails. Simulation stops, and you see an error message.

This flow chart illustrates the different stages in the process for resolving qualified data names.

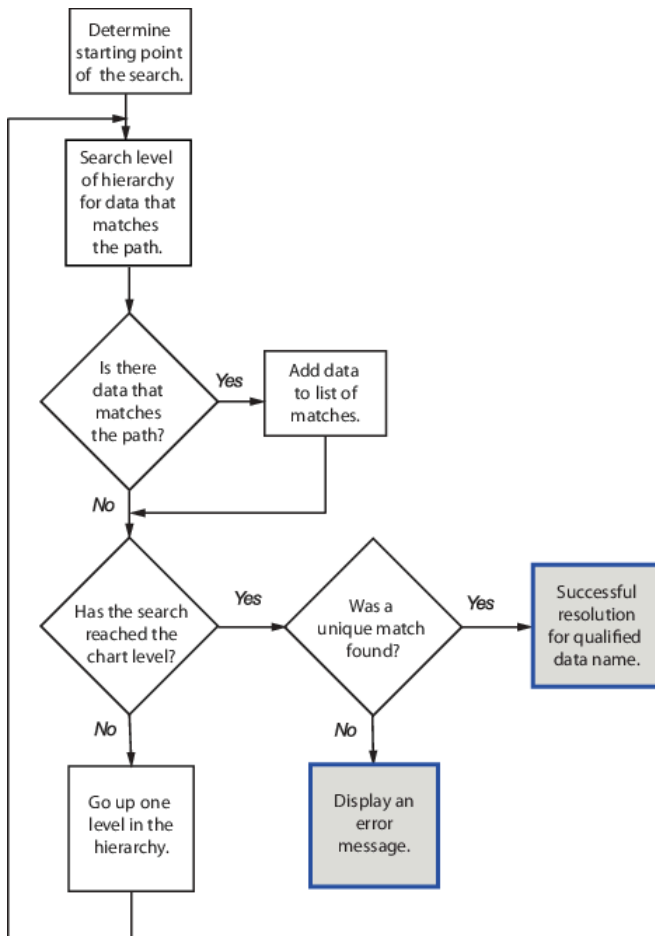

Best Practices for Using Dot Notation

Resolving qualified data names:

- Does not perform an exhaustive search of all data.
- Does not stop after finding the first match.

To improve the chances of finding a unique search result when resolving qualified data names:

- Use specific paths in qualified data names.
- Give states unique names.
- Use states and boxes as enclosures to limit the scope of the path resolution search.

Examples of Qualified Data Name Resolution

Search Produces No Matches

In this chart, the entry action in state **b** contains the qualified data name `aa.data`. If the symbol `data` resides in state `aa`, then Stateflow cannot resolve the qualified data name.

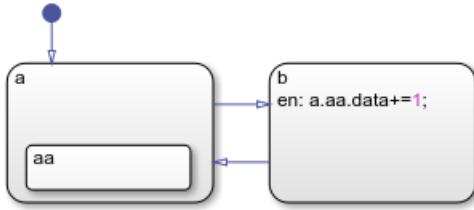

This table lists the different stages in the resolution process for the qualified data name `aa.data`.

Stage	Description	Result
1	Starting in state <code>b</code> , search for an object <code>aa</code> that contains <code>data</code> .	No match found.
2	Move up to the next level of the hierarchy (the chart level). Search for an object <code>aa</code> that contains <code>data</code> .	No match found.

The search ends at the chart level with no match found for `aa.data`, resulting in an error.

To avoid this error, in the entry action of state `b`, specify the data with the more specific qualified data name `a.aa.data`.

Search Produces Multiple Matches

In this chart, the entry action in state `a` contains two instances of the qualified data name `aa.data`. If both states named `aa` contain a data object named `data`, then Stateflow cannot resolve the qualified data name.

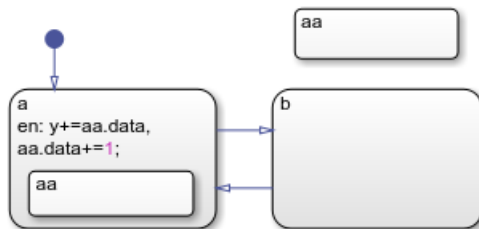

This table lists the different stages in the resolution process for the qualified data name `aa.data`.

Stage	Description	Result
1	Starting in state <code>a</code> , search for an object <code>aa</code> that contains <code>data</code> .	Match found.
2	Move up to the next level of the hierarchy (the chart level). Search for an object <code>aa</code> that contains <code>data</code> .	Match found.

The search ends at the chart level with two matches found for `aa.data`, resulting in an error.

To avoid this error:

- Use a more specific qualified data name. For instance:
 - To specify the data object in the substate of state `a`, use the qualified data name `a.aa.data`.

- To specify the data object in the top-level state `aa`, use the qualified data name `/aa.data`.
- Rename one of the states containing data.
- Enclose the top-level state `aa` in a box or in another state. Adding an enclosure prevents the search process from detecting data in the top-level state.

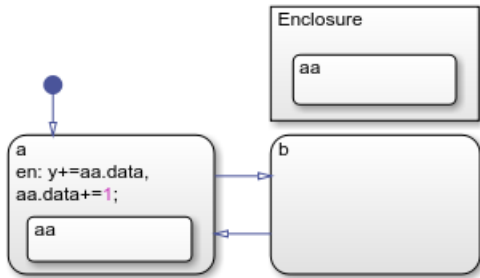

See Also

More About

- “State Action Types” on page 13-2
- “Transition Action Types” on page 13-7
- “State Hierarchy” on page 2-14

Resolve Data Properties from Simulink Signal Objects

Stateflow® local and output data in charts can explicitly inherit properties from `Simulink.Signal` objects in the model workspace or base workspace. This process is called signal resolution and requires that the resolved signal have the same name as the chart output or local data.

For information about Simulink® signal resolution, see “Symbol Resolution” (Simulink) and “Symbol Resolution Process” (Simulink).

Inherited Properties

When Stateflow local or output data resolve to Simulink signal objects, they inherit these properties:

- Size
- Complexity
- Type
- Minimum value
- Maximum value
- Initial value
- Storage class

Storage class controls the appearance of chart data in the generated code. See “Apply Built-In and Customized Storage Classes to Data Elements” (Embedded Coder).

Enable Signal Resolution

To enable explicit signal resolution, follow these steps:

- 1 Set **Configuration Parameters > Diagnostics > Data Validity > Signal resolution** to a value other than `None`. For more information about the other options, see “Signal resolution” (Simulink).
- 2 In the model workspace, base workspace, or data dictionary, define a `Simulink.Signal` object with the properties you want your Stateflow data to inherit. For more information about creating Simulink signals, see `Simulink.Signal`.
- 3 Add output or local data to a chart.
- 4 Enter a name for your data that matches the name of the `Simulink.Signal` object.
- 5 In the data properties, select the **Data must resolve to signal object** check box. After you select this check box, the dialog box removes or dims the properties that your data inherits from the signal.

A Simple Example

This model shows how a chart resolves local and output data to `Simulink.Signal` objects.

Resolve Signal Object

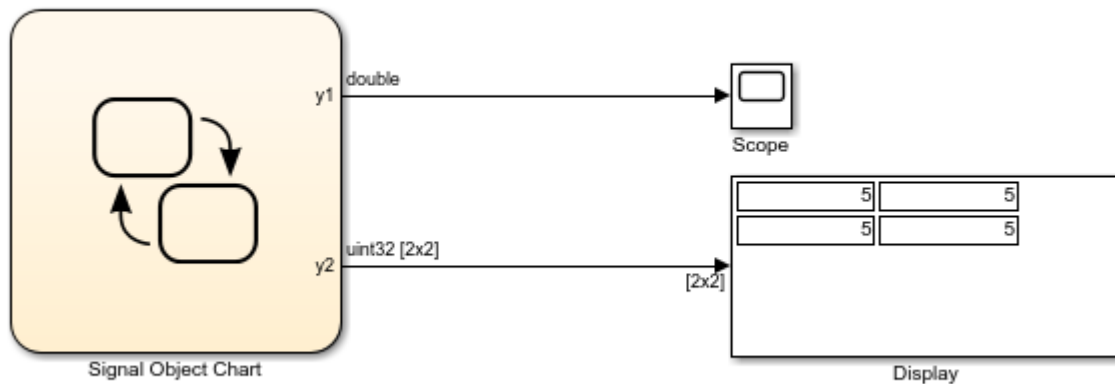

Copyright 2007-2018 The MathWorks, Inc.

In the base workspace, there are three Simulink.Signal objects, each with a different set of properties.

- y1 has these properties: **Type** = double, **Dimensions** = 1, and **Storage Class** = Model default.
- y2 has these properties: **Type** = uint32, **Dimensions** = [2 2], and **Storage Class** = Auto.
- local has these properties: **Type** = single, **Dimensions** = 1, and **Storage Class** = ExportedGlobal.

The chart contains three data objects — two outputs and a local variable — that will resolve to a signal with the same name.

The screenshot shows the Simulink Model Explorer interface. The 'Model Hierarchy' on the left shows the 'Signal Object Chart' selected. The 'Contents' pane shows a table of objects:

Name	Scope	Port	Resolve Signal	Data Type	Size	Initial Value	Compiled Type	Compiled Size
local	Local		<input checked="" type="checkbox"/>				unknown	
y1	Output	1	<input checked="" type="checkbox"/>				unknown	
y2	Output	2	<input checked="" type="checkbox"/>				unknown	

The 'Data y1' pane on the right shows the properties for the selected y1 object:

- Name: y1
- Scope: Output
- Port: 1
- Data must resolve to signal object
- Size: (empty)
- Complexity: Off
- First index: Scalar
- Initial value: Not Needed

When you build the model, each data object inherits the properties of the identically named signal.

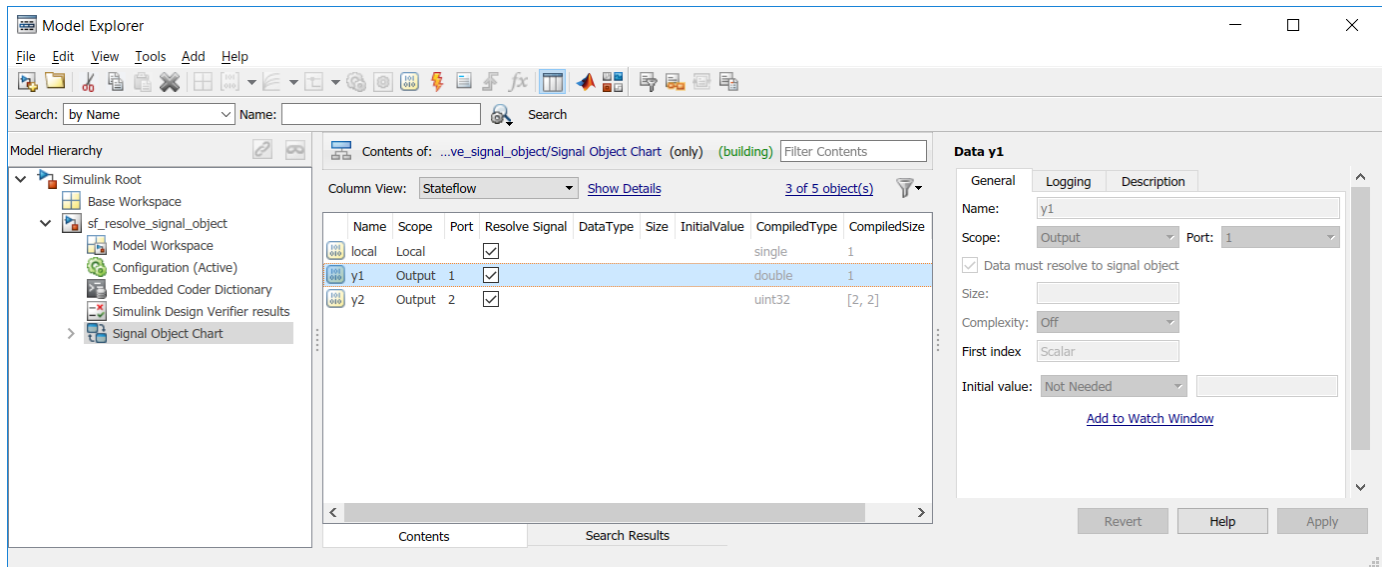

The generated code declares the data based on the storage class that the data inherits from the associated Simulink signal. For example, the header file below declares local to be an exported global variable:

```

/*
 * Exported States
 *
 * Note: Exported states are block states with an exported
 * global storage class designation.
 */
extern real32_T local;          /* '<Root>/Signal Object Chart' */

```

See Also

Simulink.Signal

More About

- “Symbol Resolution” (Simulink)
- “Apply Built-In and Customized Storage Classes to Data Elements” (Embedded Coder)

Active State Data

- “Monitor State Activity Through Active State Data” on page 10-2
- “Simplify Stateflow Charts by Incorporating Active State Output” on page 10-7
- “View State Activity by Using the Simulation Data Inspector” on page 10-11
- “Check State Activity by Using the in Operator” on page 10-14
- “Model An Intersection Of One-Way Streets” on page 10-20

Monitor State Activity Through Active State Data

Active state data can simplify the design of some Stateflow charts because you do not have to maintain data that is highly correlated to the chart hierarchy. When you enable active state data, Stateflow reports state activity through an output port to Simulink or as local data in your chart. Using active state data, you can:

- Avoid manual data updates reflecting chart activity.
- View chart activity by using a scope or the Simulation Data Inspector.
- Log chart activity for diagnostics.
- Drive other Simulink subsystems.

Types of Active State Data

When you enable active state data, Stateflow creates a Boolean or enumerated data object to match the activity type.

Activity Type	Active State Data Type	Description
Self activity	Boolean	Is the state active?
Child activity	Enumeration	Which child is active?
Leaf state activity	Enumeration	Which leaf state is active?

For self-activity of a chart or state, the data value is `true` when active and `false` when inactive. For child and leaf state activity, the data is an enumerated type. Stateflow can define the enumeration class or you can create the definition manually. For more information, see “Define State Activity Enumeration Type” on page 10-3.

You can enable active state data for a Stateflow chart, state, state transition table, or atomic subchart. This table lists the activity types supported by each kind of Stateflow object.

Stateflow Object	Self-Activity	Child Activity	Leaf State Activity
Charts	Not supported	Supported	Supported
States with exclusive (OR) decomposition	Supported	Supported	Supported
States with parallel (AND) decomposition	Supported	Not supported	Not supported
Atomic subcharts	Supported at the container level	Supported inside the subchart	Supported inside the subchart
State transition tables	Not supported	Supported	Supported

Enable Active State Data

You can enable active state data in either the Property Inspector or the Model Explorer.

- Property Inspector
 - 1 To open the Property Inspector, in the **Modeling** tab, click **Property Inspector**.

- 2 In the Stateflow Editor canvas, select the Stateflow object to monitor.
 - 3 In the **Monitoring** section of the Property Inspector, select the **Create output for monitoring** check box and edit the active state data properties.
- Model Explorer
 - 1 To open the Model Explorer, in the **Modeling** tab, click **Model Explorer**.
 - 2 In the **Model Hierarchy** pane, double-click the Stateflow object to monitor.
 - 3 In the Stateflow object pane, select the **Create output for monitoring** check box and edit the active state data properties.

Active State Data Properties

Activity Type

Type of state activity to monitor. Choose from these options:

- Self activity
- Child activity
- Leaf state activity

Data Name

Name of the active state data object. For more information, see “Rules for Naming Stateflow Objects” on page 2-5.

Enum Name

Name of the enumerated data type for the active state data object. This property applies only to child and leaf state activity.

Define Enumerated Type Manually

Specifies whether you define the enumerated data type manually. This property applies only to child and leaf state activity. For more information, see “Define State Activity Enumeration Type” on page 10-3.

Set Scope for Active State Data

By default, active state data has a scope of **Output**. Stateflow creates an output port on the chart block in the Simulink model.

To access active state data inside a Stateflow chart, change the scope to **Local** in the Symbols pane or in the Model Explorer. For more information, see “Set Data Properties” on page 9-5.

You can specify information for code generation by binding the local active state data to a `Simulink.Signal` object. Modify the properties of the object through the `CoderInfo` property. For more information, see `Simulink.CoderInfo`.

Define State Activity Enumeration Type

By default, Stateflow defines the enumeration data type for child and leaf activity. If you select the **Define enumerated type manually** check box and no enumeration data type definition exists, then

Stateflow provides a link to create a definition. Clicking the **Create enum definition from template** link generates a customizable definition.

The screenshot shows the configuration window for a state named 'gear_state'. It has two tabs: 'Properties' and 'Info', with 'Info' currently selected. The 'Execution order' is a dropdown menu set to '1'. Below this is a section titled 'Monitoring' with a downward arrow. Inside this section, there is a checked checkbox for 'Create output for monitoring' and a dropdown menu for 'Child activity' set to 'Child activity'. Below these are two text input fields: 'Data name' containing 'gear' and 'Enum name' containing 'gearType'. At the bottom of the 'Monitoring' section, there is another checked checkbox for 'Define enumerated type manually' and a blue hyperlink labeled 'Create enum definition from template'.

The enumeration data type definition contains one literal for each state name plus an extra literal to indicate that no substate is active. For example, in the model `sf_car`, the state `gear_state` contains four child states that correspond to the gears in a car: `first`, `second`, `third`, `fourth`. The model specifies the child activity data type with this enumeration class definition:

```
classdef gearType < Simulink.IntEnumType
    enumeration
        None(0),
        first(1),
        second(2),
        third(3),
        fourth(4)
    end
    ...
end
```

For more information, see “Define Enumerated Data Types” on page 20-5.

The base storage type for automatically created enumerations defaults to `Native Integer`. For a smaller memory footprint, in the **Optimization** pane of the Configuration Parameters dialog box, change the value of the **Base storage type for automatically created enumerations** field. For more information, see “Base storage type for automatically created enumerations” (Simulink Coder).

State Activity and Parallel States

In states with parallel (AND) decomposition, child activity and leaf state activity are not available because the parallel substates are active simultaneously.

When you enable leaf state activity in a chart or state, a substate with parallel (AND) decomposition is treated as a leaf state. For example, suppose that you enable leaf state activity for this chart.

Because state B has parallel decomposition, its substates B1 and B2 are active simultaneously so B is treated as a leaf state of the chart.

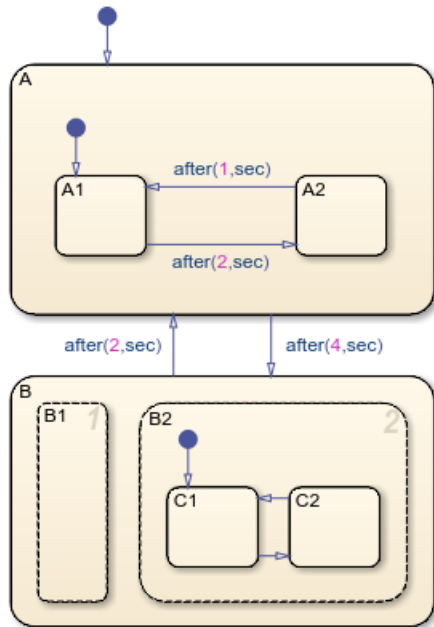

During simulation, a scope connected to the active state output data shows the enumerated values for the leaf states A1, A2, and B.

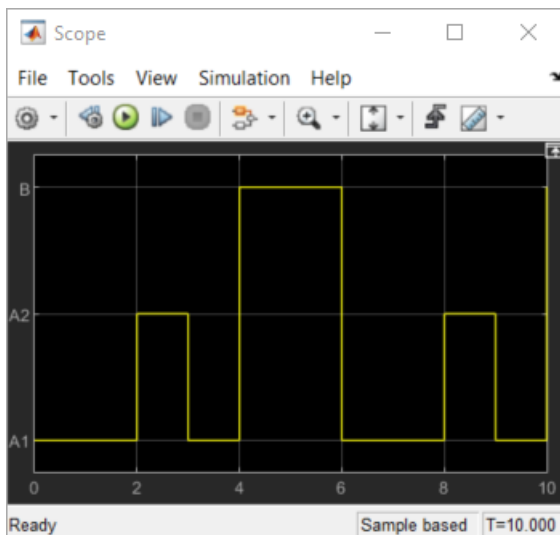

Limitations for Active State Data

- Enabling child activity output for states that have no children results in an error at compilation and run time.
- You cannot enable child or leaf state activity in charts or states with parallel decomposition. To check state activity in substates of parallel states, use the `in` operator. For more information, see “Check State Activity by Using the `in` Operator” on page 10-14.

- Do not select the chart property **Initialize Outputs Every Time Chart Wakes Up** on charts that use active state output data. With this setting, the behavior of the output data is unpredictable.

See Also

`Simulink.Signal` | `Simulink.CoderInfo`

More About

- “Simplify Stateflow Charts by Incorporating Active State Output” on page 10-7
- “View State Activity by Using the Simulation Data Inspector” on page 10-11
- “Check State Activity by Using the in Operator” on page 10-14
- “Rules for Naming Stateflow Objects” on page 2-5
- “Define State Activity Enumeration Type” on page 10-3
- “Base storage type for automatically created enumerations” (Simulink Coder)

Simplify Stateflow Charts by Incorporating Active State Output

Active state data can simplify the design of some Stateflow® charts because you do not have to maintain data that is highly correlated to the chart hierarchy. When you enable active state data, Stateflow reports state activity through an output port to Simulink® or as local data in your chart. This example shows how to simplify the design of a Stateflow chart by adding active state output data. For more information, see “Monitor State Activity Through Active State Data” on page 10-2.

In the legacy model `old_sf_car`, the Stateflow chart `shift_logic` tracks child state activity in `gear_state` by updating the value of the output data `gear`.

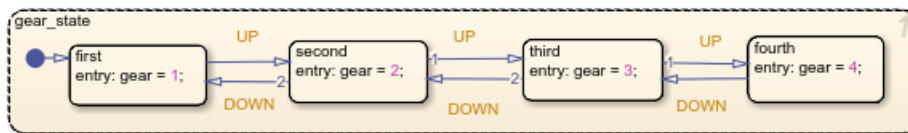

By incorporating active state data, the model `sf_car` avoids manual data updates reflecting chart activity. Instead, the chart outputs child state activity automatically through the active state output `gear`.

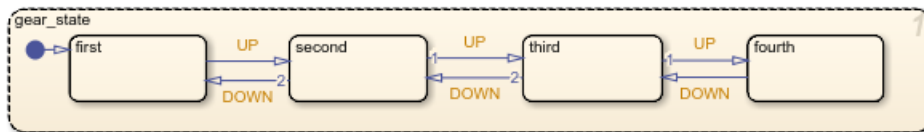

Modify the Model

To simplify the design of the `old_sf_car` model, eliminate data that is highly correlated to the chart hierarchy and enable automatic monitoring of child state activity in `gear_state`.

Step 1: Eliminate Manual Tracking of State Activity

- 1 In the model `old_sf_car`, open the chart `shift_logic`.
- 2 Open the Symbols pane. In the **Modeling** tab, select **Symbols Pane**.
- 3 In each substate of `gear_state`, delete the entry action assigning a value to the output data variable `gear`.
- 4 In the Symbols pane, right-click the output variable `gear` and select **Delete**.

Step 2: Enable Active State Output

- 1 Open the Property Inspector. In the **Modeling** tab, select **Property Inspector**.
- 2 In the Stateflow Editor, select the state `gear_state`.
- 3 In the Property Inspector, select the **Create output for monitoring** check box and choose **Child activity**.
- 4 In the **Data name** field, enter the name `gear` of the active state data.
- 5 In the **Enum name** field, enter the name `gearType` of the enumeration data type for the active state data.

gear_state

Properties Info

Execution order 1

▼ Monitoring

Create output for monitoring Child activity

Data name gear

Enum name gearType

Define enumerated type manually

Step 3: Connect Signal to Simulink Blocks

- 1 In the Simulink model, add a Cast To Double block. This block converts the enumerated output from the Stateflow chart to a signal of type double. For more information, see Data Type Conversion.
- 2 Connect the output signal `gear` from the `shift_logic` chart to the Cast To Double block.
- 3 Connect the output signal from the Cast To Double block to the Transmission subsystem.
- 4 Add a Memory block. This block prevents an algebraic loop between the Stateflow chart and the Threshold Calculation subsystem.
- 5 Make a second connection from the output signal from the Cast To Double block to the Memory block.
- 6 Connect the output of the Memory block to the Threshold Calculation subsystem.

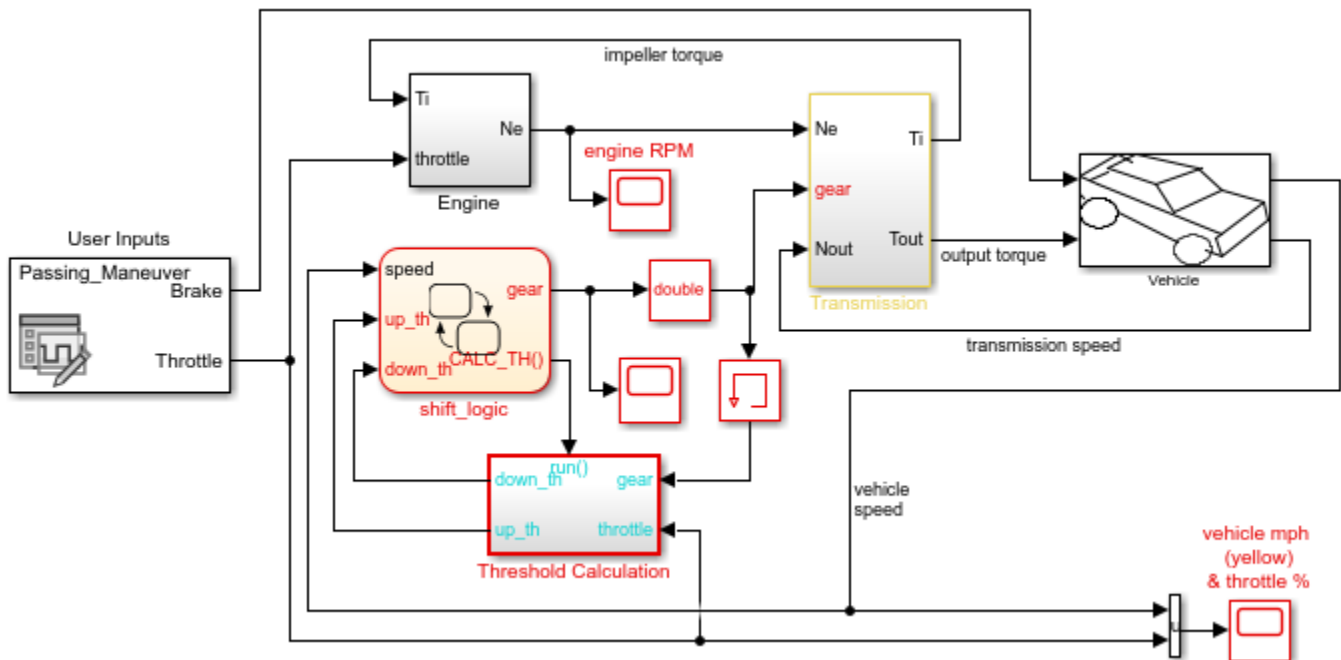

View Simulation Results

The output signal `gear` is an enumerated type managed by Stateflow. You can view the active state output signal `gear` during simulation by connecting the chart to a Scope block. The names of the enumerated values match the names of the substates in `gear_state`. The additional enumerated value of `None` indicates time steps when no child is active.

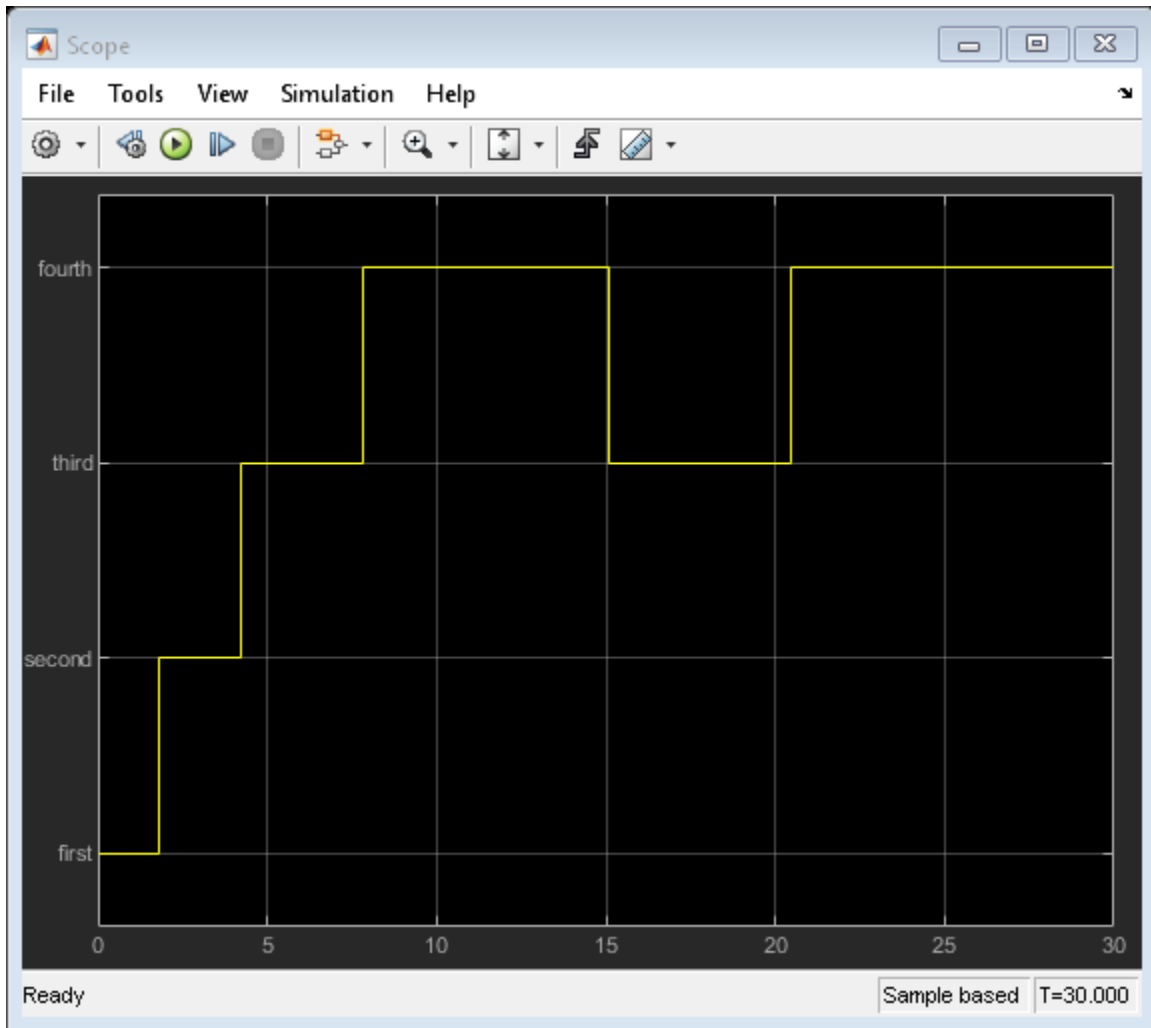

See Also

Data Type Conversion | Memory

More About

- “Monitor State Activity Through Active State Data” on page 10-2
- “View State Activity by Using the Simulation Data Inspector” on page 10-11
- “Manage Data, Events, and Messages in the Symbols Pane” on page 34-2

View State Activity by Using the Simulation Data Inspector

You can use the Simulation Data Inspector to log state activity and data for your Stateflow chart in a Simulink model. With the Simulation Data Inspector, you can view and compare:

- Data from your chart
- Leaf chart activity
- Child chart activity
- Child state activity
- Self state activity
- Leaf state activity

Log to the Simulation Data Inspector from Stateflow

In this exercise, you use the Simulation Data Inspector to monitor the active state outputs for the Stateflow chart in the model `sf_car`.

To log a signal with the Simulation Data Inspector, highlight the signal line that you want to log. Right-click the `gear` signal and choose **Log Selected Signals** from the context menu. A logging badge appears next to the `gear` signal, indicating that the data from that signal is logged when the model is run.

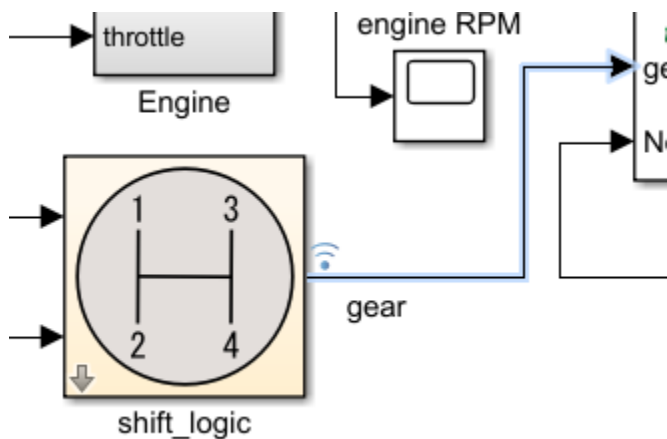

The logging badge  marks logged signals in the model.

To log the active state data from `gear_state`:

- 1 Open the Stateflow chart.
- 2 To select `gear_state`, click `gear_state`.
- 3 On the Simulink Editor toolbar, in the **Simulation** tab, click **Log Child Activity**.

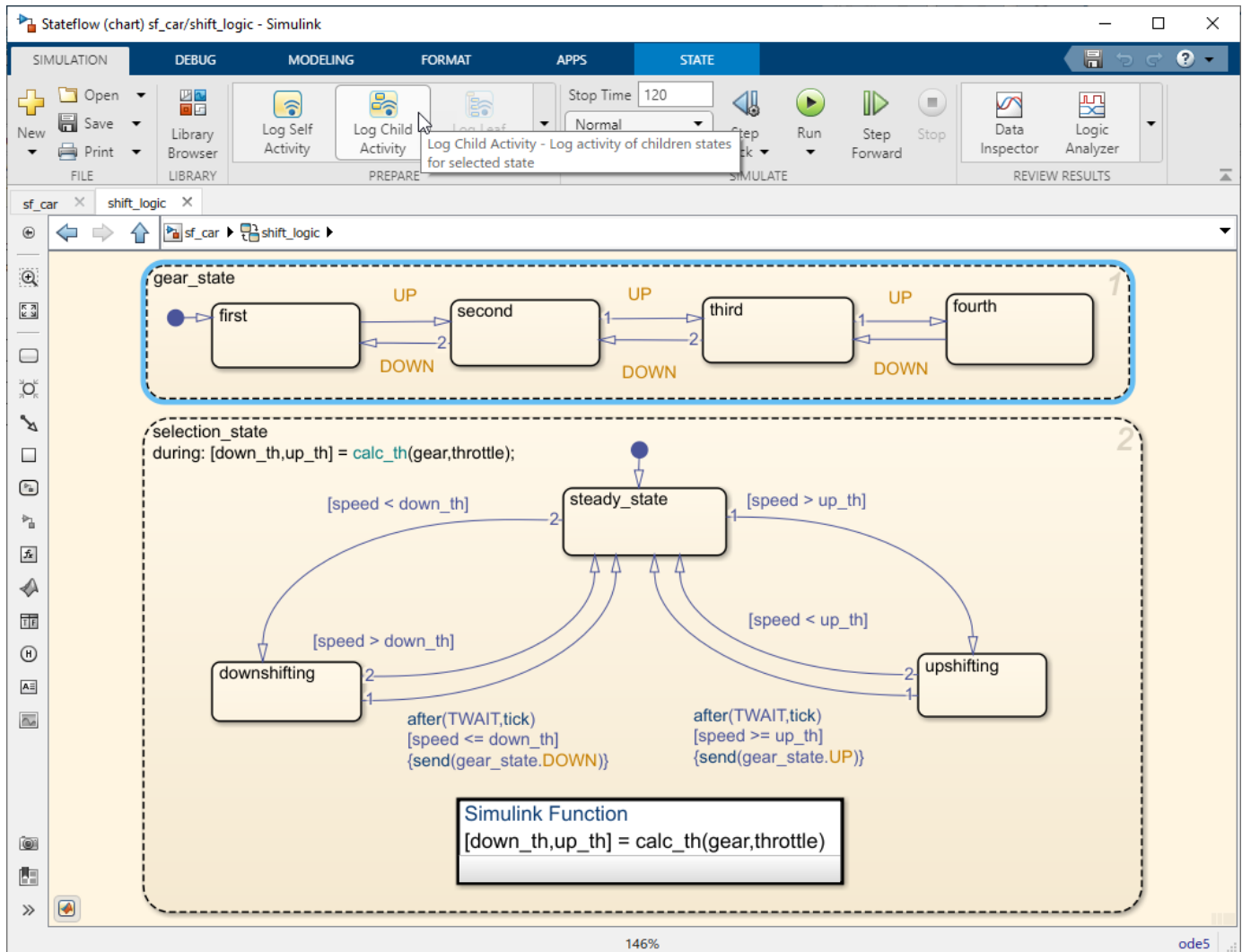

After running one or more simulations with signals marked for logging, click **Simulation Data**

Inspector button  on the Simulink editor toolbar and view your data. Multiple runs show up in the **Inspect** pane and can be viewed together. To choose which signals you want to plot, use the check boxes next to the signal names.

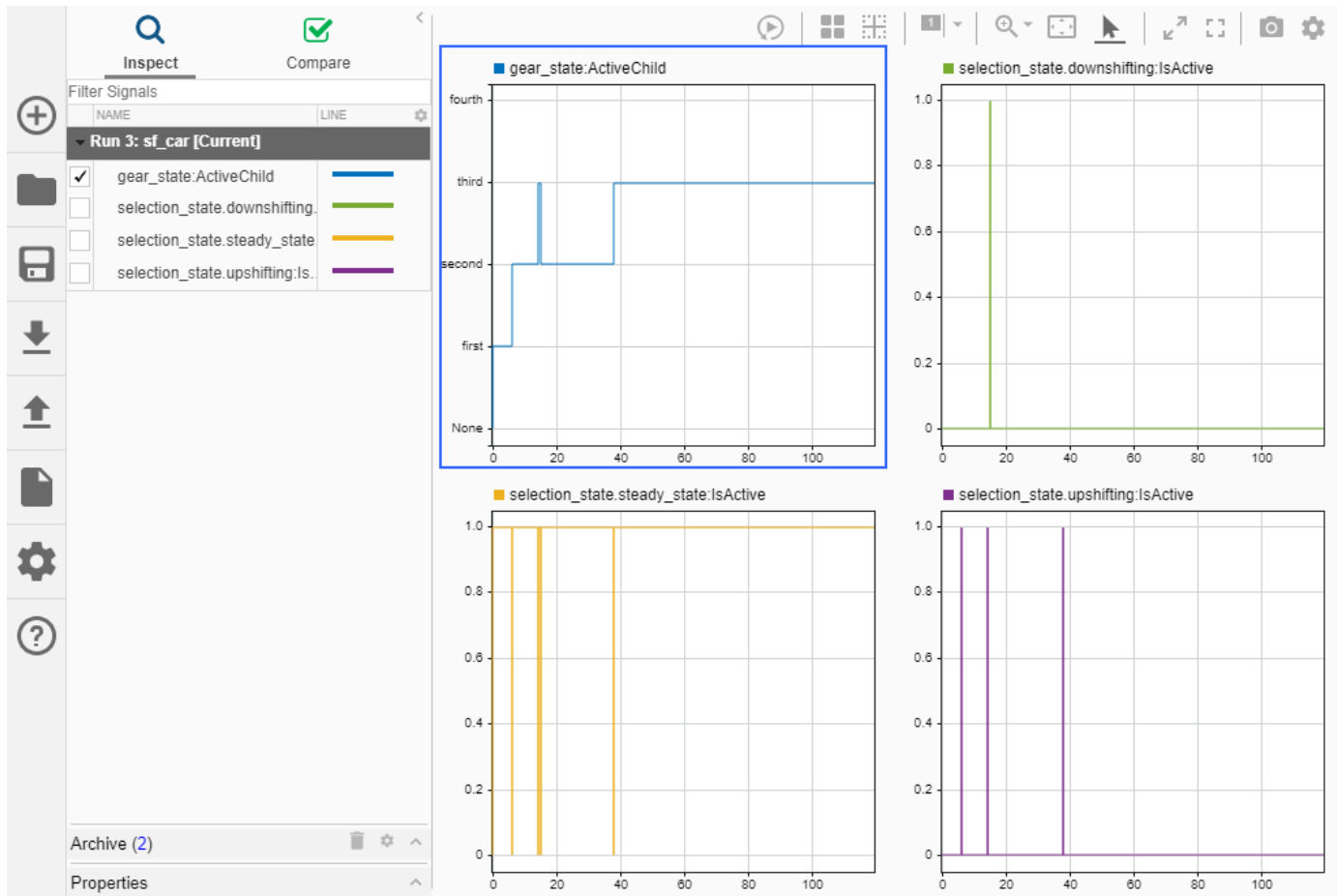

See Also

More About

- “Monitor State Activity Through Active State Data” on page 10-2
- “Simplify Stateflow Charts by Incorporating Active State Output” on page 10-7
- Simulation Data Inspector
- “Inspect Simulation Data” (Simulink)
- “Compare Simulation Data” (Simulink)

Check State Activity by Using the in Operator

In a Stateflow chart with parallel state decomposition, substates can be active at the same time. To coordinate the behavior of different parallel states, one state can check the substate activity of another state and react accordingly. For example, one state can keep its substates synchronized with the substates of the other state.

The in Operator

To check if a state is active in a given time step, call the `in` operator in state and transition actions. The `in` operator takes a qualified state name `state_name` and returns a Boolean output. If state `state_name` is active, `in` returns a value of 1 (true). Otherwise, `in` returns a value of 0 (false).

`in(state_name)`

For example, in this chart, Fan and Heater are parallel (AND) states. Each state has a pair of substates, On and Off. Every time the chart wakes up, the active substate of the state Fan alternates between Fan.Off and Fan.On. In the state Heater, the conditions on the transitions check the substate activity in Fan and keep the states synchronized. A change of active substate in Fan causes a corresponding change of active substate in Heater.

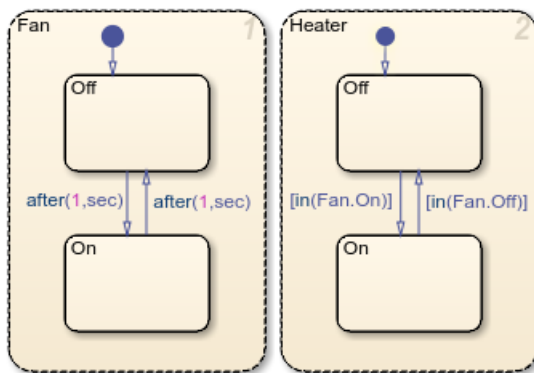

Resolution of State Activity

Checking state activity is a two-part process. First, the Stateflow chart resolves the qualified state name by performing a localized search of the chart hierarchy for a matching state. Then, the chart determines if the matching state is active.

The search begins at the hierarchy level where the `in` operator is called with the qualified state name:

- For a state action, the starting point is the state containing the action.
- For a transition label, the starting point is the parent of the transition source.

The resolution process searches each level of the chart hierarchy for a path to the state. If a state matches the path, the process adds that state to the list of possible matches. Then, the process continues the search one level higher in the hierarchy. The resolution process stops after it searches the chart level of the hierarchy. If a unique match exists, the chart checks if the matching state is active. Otherwise, the resolution process fails. Simulation stops with an error.

This flow chart illustrates the different stages in the process for checking state activity.

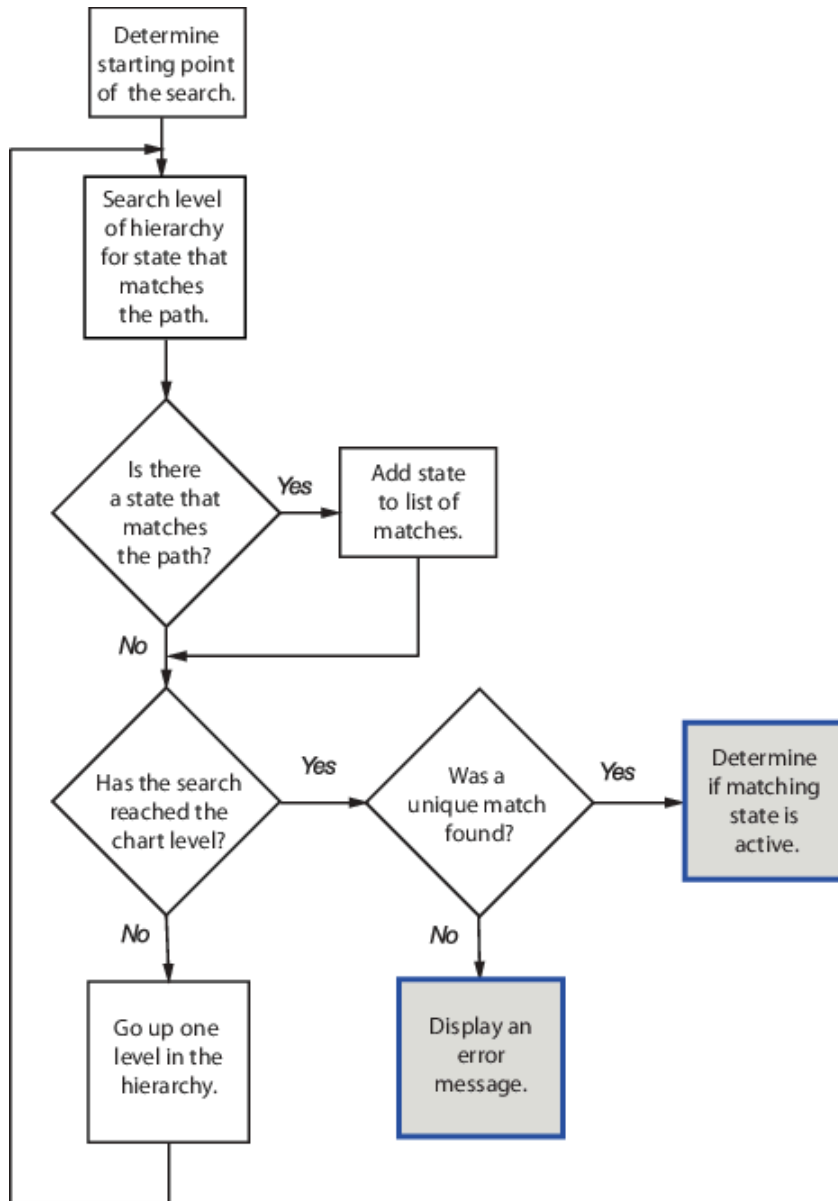

Best Practices for Checking State Activity

To resolve the state activity, a Stateflow chart does not perform an exhaustive search for all states and does not stop after finding the first match. To improve the chances of finding a unique search result:

- Use specific paths in qualified data names.
- Give states unique names.
- Use states and boxes as enclosures to limit the scope of the path resolution search.

Examples of State Activity Resolution

Search Finds Local Copy of Substate

This chart contains two parallel states, A and B. Each state has a pair of substates, A1 and A2. A1 has substates X and Y, while A2 has substates P and Q. In A.A2 and in B.A2, the condition `in(A1.Y)` guards the transition from P to Q.

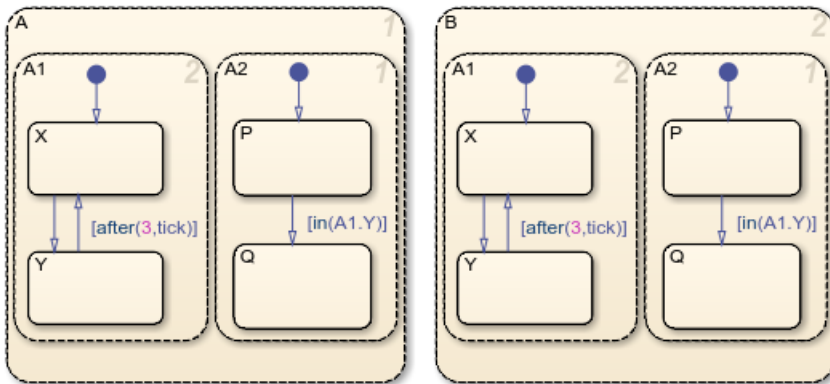

The chart resolves each qualified state name as the local copy of the substate Y:

- In the state A, the condition `in(A1.Y)` checks the activity of state A.A1.Y.
- In the state B, the condition `in(A1.Y)` checks the activity of state B.A1.Y.

For example, this table lists the different stages in the resolution process for the transition condition in state A.

Stage	Description	Result
1	Starting in state A.A2, the chart searches for the state A.A2.A1.Y.	No match found.
2	Moving up to the next level of the hierarchy (state A), the chart searches for the state A.A1.Y	Match found.
3	Moving up to the next level of the hierarchy (the chart level), the chart searches for the state A1.Y	No match found.

The search ends with a single match found. Because the resolution algorithm localizes the scope of the search, the `in` operator guarding the transition in A.A2 detects only the state A.A1.Y. The `in` operator guarding the transition in B.A2 detects only the state B.A1.Y.

To check the state activity of the other copy of Y, use more specific qualified state names:

- In state A, use the expression `in(B.A1.Y)`.
- In state B, use the expression `in(A.A1.Y)`.

Search Produces No Matches

In this chart, the `during` action in state A.B contains the expression `in(Q.R)`. Stateflow cannot resolve the qualified state name Q.R.

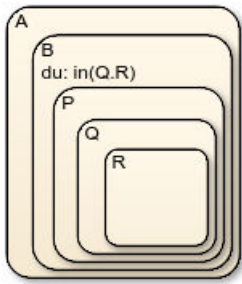

This table lists the different stages in the resolution process.

Stage	Description	Result
1	Starting in state A.B, the chart searches for the state A.B.Q.R.	No match found.
2	Moving up to the next level of the hierarchy (state A), the chart searches for the state A.Q.R.	No match found.
3	Moving up to the next level of the hierarchy (the chart level), the chart searches for the state Q.R.	No match found.

The search ends at the chart level with no match found for Q.R, resulting in an error.

To avoid this error, use a more specific qualified state name. For instance, check state activity by using the expression in(P.Q.R).

Search Finds the Wrong State

In this chart, the during action in state A.B contains the expression in(Q.R). When resolving the qualified state name Q.R, Stateflow cannot detect the substate A.B.P.Q.R.

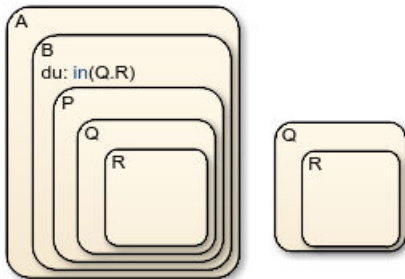

This table lists the different stages in the resolution process.

Stage	Description	Result
1	Starting in state A.B, the chart searches for the state A.B.Q.R.	No match found
2	Moving up to the next level of the hierarchy (state A), the chart searches for the state A.Q.R.	No match found.
3	Moving up to the next level of the hierarchy (the chart level), the chart searches for the state Q.R.	Match found.

The search ends with a single match found. The `in` operator detects only the substate R of the top-level state Q.

To check the state activity of A.B.P.Q.R, use a more specific qualified state name. For instance, use the expression `in(P.Q.R)`.

Search Produces Multiple Matches

In this chart, the `during` action in state A.B contains the expression `in(P.Q.R)`. Stateflow cannot resolve the qualified state name P.Q.R.

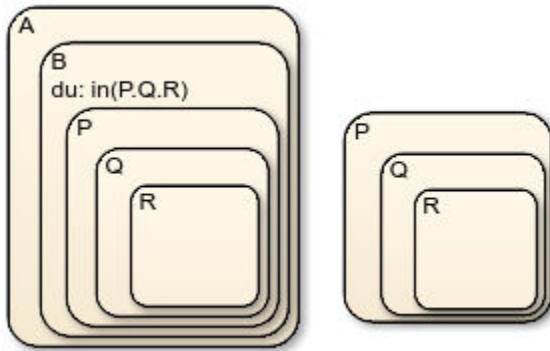

This table lists the different stages in the resolution process.

Stage	Description	Result
1	Starting in state A.B, search for the state A.B.P.Q.R.	Match found
2	Moving up to the next level of the hierarchy (state A), the chart searches for the state A.P.Q.R.	No match found.
3	Moving up to the next level of the hierarchy (the chart level), the chart searches for the state P.Q.R.	Match found.

The search ends at the chart level with two matches found for P.Q.R, resulting in an error.

To avoid this error:

- Use a more specific qualified state name. For instance:
 - To check the substate activity inside B, use the expression `in(B.P.Q.R)`.
 - To check the substate activity in the top-level state P, use the expression `in(\P.Q.R)`.
- Rename one of the matching states.
- Enclose the top-level state P in a box or another state. Adding an enclosure prevents the search process from detecting substates in the top-level state.

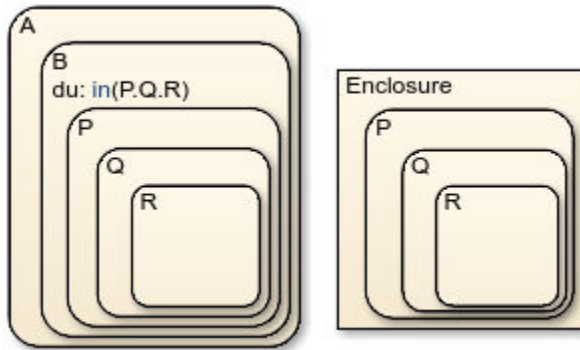

See Also

after | in

More About

- “State Action Types” on page 13-2
- “Transition Action Types” on page 13-7
- “State Hierarchy” on page 2-14
- “Monitor State Activity Through Active State Data” on page 10-2

Model An Intersection Of One-Way Streets

This example models an intersection of one-way roads controlled by a Stateflow® traffic light system. The Stateflow chart tracks the state of each traffic light by using active state output. The behavior of the traffic lights is controlled by parameters on the Stateflow mask.

Intersection Model

The phase of the animated traffic lights is determined by the output data from the Stateflow chart. The value of the output data corresponds to the active child of the substates `Light1Controller` and `Light2Controller`, respectively.

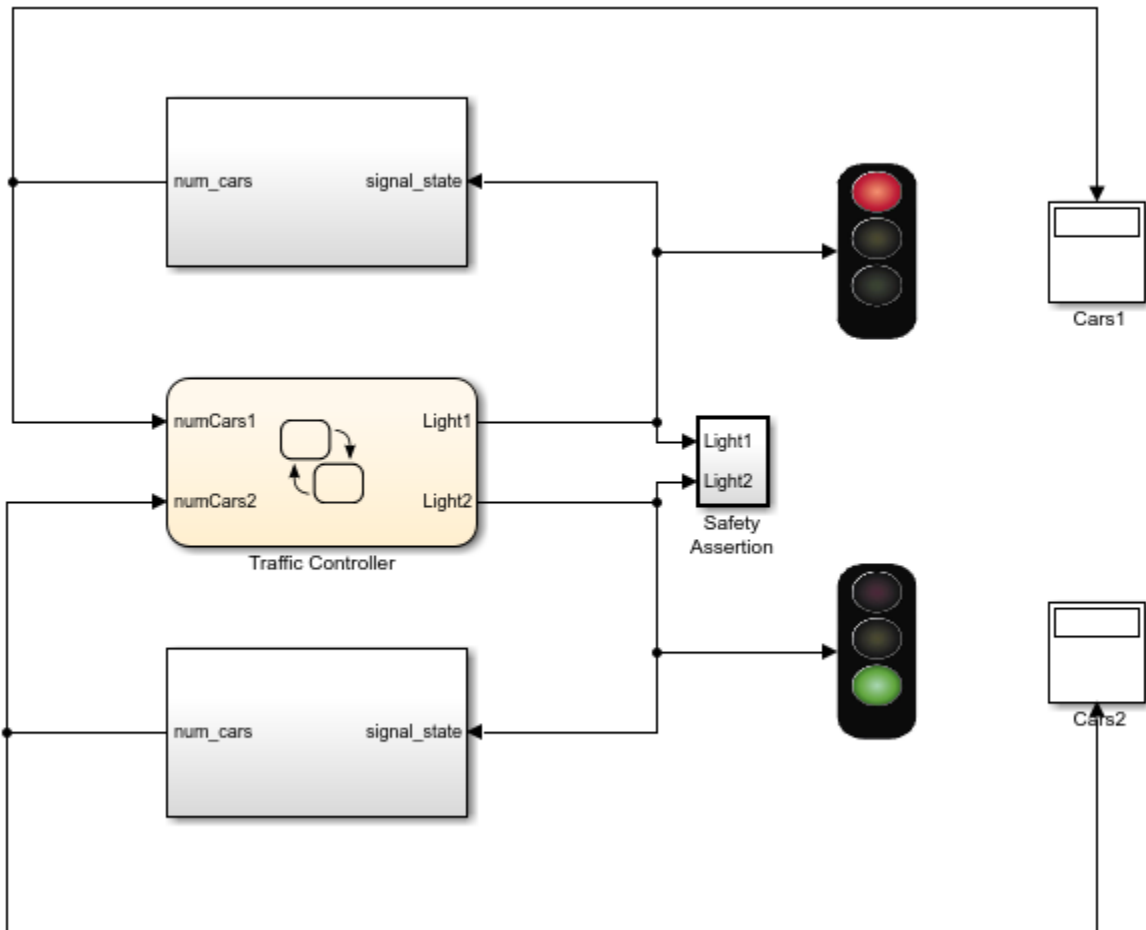

Traffic Controller

The Stateflow chart Traffic Controller manages two traffic controllers in parallel. Each controller determines the phase of the downstream traffic light based on traffic congestion at the intersection, an input from Simulink®, and parameters on the chart's mask. For more information, see “Create a Mask to Share Parameters with Simulink” on page 25-14.

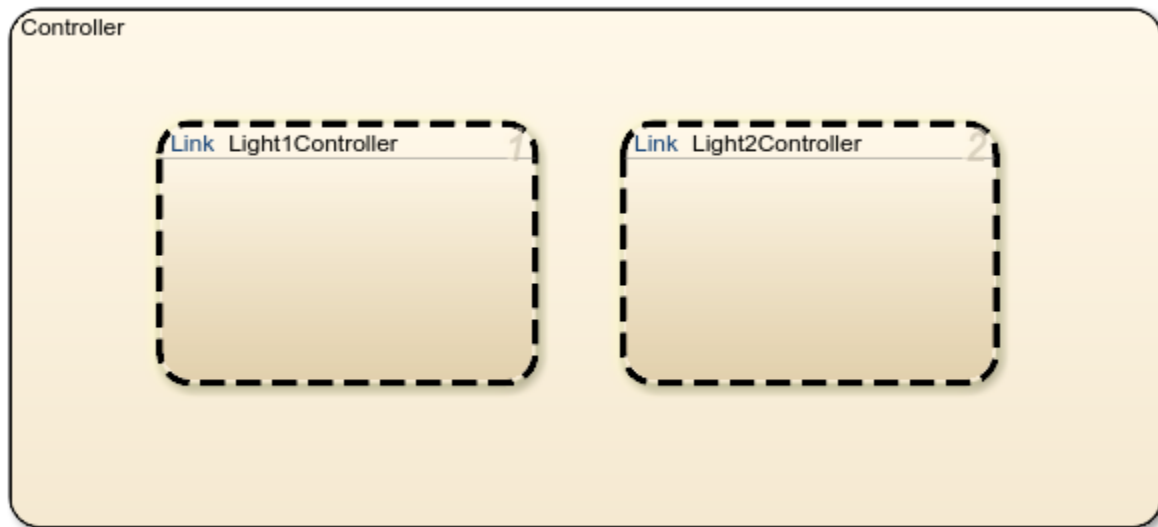

Active State Output

The child activity of both `Light1Controller` and `Light2Controller` is output to Simulink through a data of enumerated type. Stateflow manages this data automatically. For more information, see "Monitor State Activity Through Active State Data" on page 10-2.

- Open one of the Light controllers (for instance, `Light1Controller`).
- Right click and select Properties.
- Notice that the **Create output for monitoring** option is selected and set to `Child` activity.
- The field **Data name** corresponds to the name of the output data on the linked instance.
- This output is mapped to a chart level output called `Light1`.

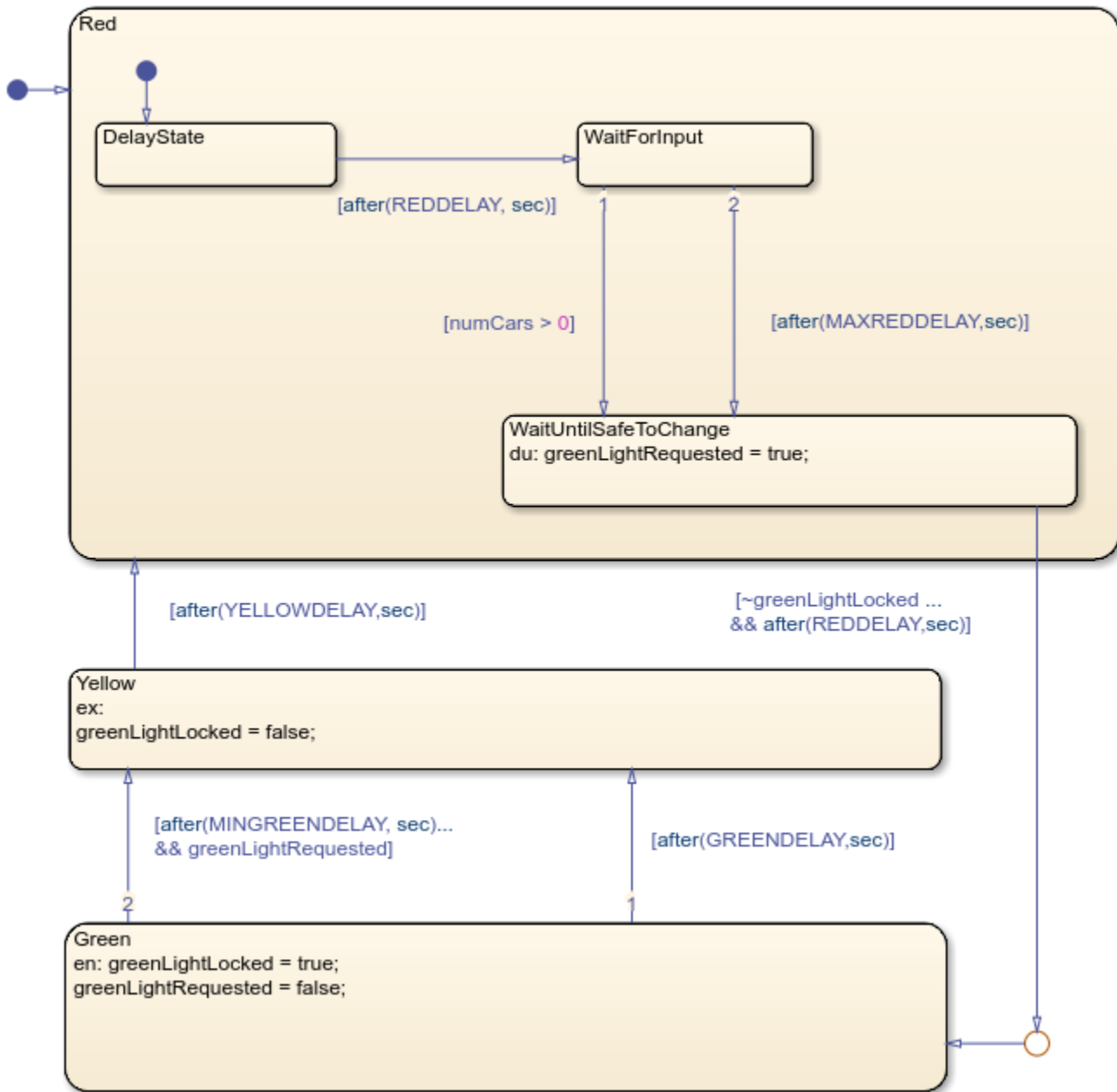

Simulation

Simulate the model to see the traffic light blocks animate.

See Also

More About

- “Monitor Chart Activity by Using Active State Data”
- “Monitor State Activity Through Active State Data” on page 10-2

- “Model a Distributed Traffic Control System by Using Messages” on page 12-29

Define Events

- “Synchronize Model Components by Broadcasting Events” on page 11-2
- “Set Properties for an Event” on page 11-5
- “Activate a Stateflow Chart by Sending Input Events” on page 11-7
- “Control States in Charts Enabled by Function-Call Input Events” on page 11-11
- “Activate a Simulink Block by Sending Output Events” on page 11-14
- “Control Chart Behavior by Using Implicit Events” on page 11-23
- “Count Events by Using the temporalCount Operator” on page 11-26
- “Yo-Yo Control of Satellites” on page 11-27

Synchronize Model Components by Broadcasting Events

An event is a Stateflow object that can trigger actions in one of these objects:

- A parallel state in a Stateflow chart.
- Another Stateflow chart.
- A Simulink triggered or function-call subsystem.

For simulation purposes, there is no limit to the number of events in a Stateflow chart. However, for code generation, the underlying C compiler enforces a theoretical limit of $2^{31}-1$ events.

Types of Events

An implicit event is a built-in event that is broadcast during chart execution. These events are implicit because you do not define or trigger them explicitly. For more information, see “Control Chart Behavior by Using Implicit Events” on page 11-23.

An explicit event is an event that you define explicitly. Explicit events can have one of these scopes.

Scope	Description
Input	Event that is broadcast to a Stateflow chart from outside the chart. For more information, see “Activate a Stateflow Chart by Sending Input Events” on page 11-7 and “Design Human-Machine Interface Logic by Using Stateflow Charts” on page 35-24.
Local	Event that can occur anywhere in a Stateflow chart but is visible only in the parent object and its descendants. Local events are supported only in Stateflow charts in Simulink models. For more information, see “Broadcast Local Events to Synchronize Parallel States” on page 13-37.
Output	Event that occurs in a Stateflow chart but is broadcast to a Simulink block. Output events are supported only in Stateflow charts in Simulink models. For more information, see “Activate a Simulink Block by Sending Output Events” on page 11-14.

You can define explicit events at these levels of the Stateflow hierarchy.

Level of Hierarchy	Visibility
Chart	Event is visible to the chart and all its states and substates.
Subchart	Event is visible to the subchart and all its states and substates.
State	Event is visible to the state and all its substates.

Define Events in a Chart

You can add events to a Stateflow chart by using the Symbols pane, the Stateflow Editor menu, or the Model Explorer.

Add Events Through the Symbols Pane

- 1 In the **Modeling** tab, under **Design Data**, select **Symbols Pane**.

- 2 Click the **Create Event** icon .
- 3 In the row for the new event, under **TYPE**, click the icon and choose:
 - Input Event
 - Local Event
 - Output Event
- 4 Edit the name of the event.
- 5 For input and output events, click the **PORT** field and choose a port number.
- 6 To specify properties for the event, open the Property Inspector. In the Symbols pane, right-click the row for the event and select **Explore**. For more information, see “Set Properties for an Event” on page 11-5.

Add Events by Using the Stateflow Editor Menu

- 1 In a Stateflow chart in a Simulink model, select the menu option corresponding to the scope of the event that you want to add.

Scope	Menu Option
Input	In the Modeling tab, under Design Data , click Event Input .
Output	In the Modeling tab, under Design Data , click Event Output .
Local	In the Modeling tab, under Design Data , click Local Event .

- 2 In the Event dialog box, specify data properties. For more information, see “Set Properties for an Event” on page 11-5.

Add Events Through the Model Explorer

- 1 In the **Modeling** tab, under **Design Data**, select **Model Explorer**.
- 2 In the **Model Hierarchy** pane, select the object in the Stateflow hierarchy where you want to make the new event visible. The object that you select becomes the parent of the new event.
- 3 In the Model Explorer menu, select **Add > Event**. The new event with a default definition appears in the **Contents** pane of the Model Explorer.
- 4 In the **Event** pane, specify the properties of the event. For more information, see “Set Properties for an Event” on page 11-5.

Access Event Information from a Stateflow Chart

You can display the properties of an input or local event, or open the destination of an output event directly from a Stateflow chart. Right-click the state or transition that contains the event of interest and select **Explore**. A context menu lists the names and scopes of all resolved symbols in the state or transition. Selecting an input or local event from the context menu displays its properties in the Model Explorer. Selecting an output event from the context menu opens the Simulink subsystem or Stateflow chart associated with the event.

Best Practices for Using Events in Stateflow Charts

Use the send Command to Broadcast Explicit Events in Actions

To broadcast explicit events in state or transition actions, use the `send` command. Using this command enhances readability of a chart and ensures that explicit events are not mistaken for data. For more information, see “Broadcast Local Events to Synchronize Parallel States” on page 13-37.

Avoid Using Explicit Events to Trigger Conditional Actions

Use conditions on transitions instead of events when you want to:

- Represent conditional statements, for example, `[x < 1]` or `[x == 0]`.
- Represent a change of data value, for example, `[hasChanged(x)]`.

For more information, see “Transition Action Types” on page 13-7.

Avoid Using the Implicit Event enter to Check State Activity

To check state activity, use the `in` operator instead of the implicit event `enter`. For more information, see “Check State Activity by Using the in Operator” on page 10-14.

Do Not Mix Edge-Triggered and Function-Call Input Events in a Chart

Mixing input events that use edge triggers and function calls results in an error during parsing and simulation.

See Also

More About

- “Set Properties for an Event” on page 11-5
- “Broadcast Local Events to Synchronize Parallel States” on page 13-37
- “Activate a Stateflow Chart by Sending Input Events” on page 11-7
- “Activate a Simulink Block by Sending Output Events” on page 11-14
- “Rules for Naming Stateflow Objects” on page 2-5
- “Identify Data by Using Dot Notation” on page 9-39

Set Properties for an Event

When you create Stateflow charts in Simulink models, you can specify event properties in either the Property Inspector or the Model Explorer.

- To use the Property Inspector:
 - 1 In the **Modeling** tab, under **Design Data**, select **Symbols Pane** and **Property Inspector**.
 - 2 In the Symbols pane, select the event.
 - 3 In the Property Inspector pane, edit the event properties.
- To use the Model Explorer:
 - 1 In the **Modeling** tab, under **Design Data**, select **Model Explorer**.
 - 2 In the **Contents** pane, select the event.
 - 3 In the **Message** pane, edit the event properties.

For more information, see “Synchronize Model Components by Broadcasting Events” on page 11-2.

Stateflow Event Properties

Name

Name of the event. Actions reference events by their names. Names must begin with an alphabetic character, cannot include spaces, and cannot be shared by sibling events. For more information, see “Rules for Naming Stateflow Objects” on page 2-5.

Scope

Scope of the event. The scope specifies where the event occurs relative to the parent object.

Scope	Description
Local	Event that can occur anywhere in a Stateflow machine but is visible only in the parent object and its descendants. For more information, see “Directed Event Broadcasting” on page 13-37.
Input from Simulink	Event that occurs in a Simulink block but is broadcast to a Stateflow chart. For more information, see “Activate a Stateflow Chart by Sending Input Events” on page 11-7.
Output to Simulink	Event that occurs in a Stateflow chart but is broadcast to a Simulink block. For more information, see “Activate a Simulink Block by Sending Output Events” on page 11-14.

Port

Index of the port associated with the event. This property applies only to input and output events.

- For input events, port is the index of the input signal that triggers the event. For more information, see “Association of Input Events with Control Signals” on page 11-9.
- For output events, port is the index of the signal that outputs this event. For more information, see “Association of Output Events with Output Ports” on page 11-22.

Trigger

Type of signal that triggers an input or output event. For more information, see “Activate a Stateflow Chart by Sending Input Events” on page 11-7 and “Activate a Simulink Block by Sending Output Events” on page 11-14.

Debugger Breakpoints

Option for setting debugger breakpoints at the start or end of an event broadcast. Available breakpoints depend on the scope of the event.

Scope of Event	Start of Broadcast	End of Broadcast
Local	Available	Available
Input	Available	Not available
Output	Not available	Not available

For more information, see “Set Breakpoints to Debug Charts” on page 33-3.

Description

Description of the event. You can enter brief descriptions of events in the hierarchy.

Document Link

Link to online documentation for the event. You can enter a web URL address or a MATLAB command that displays documentation in a suitable online format, such as an HTML file or text in the MATLAB Command Window. When you click the **Document link** hyperlink, Stateflow displays the documentation.

See Also

More About

- “Synchronize Model Components by Broadcasting Events” on page 11-2
- “Directed Event Broadcasting” on page 13-37
- “Activate a Stateflow Chart by Sending Input Events” on page 11-7
- “Activate a Simulink Block by Sending Output Events” on page 11-14
- “Rules for Naming Stateflow Objects” on page 2-5
- “Identify Data by Using Dot Notation” on page 9-39

Activate a Stateflow Chart by Sending Input Events

An input event occurs outside a Stateflow chart but is visible only in that chart. This type of event enables other Simulink blocks, including other Stateflow charts, to notify a specific chart of events that occur outside it. To define an input event:

- 1 Add an event to the Stateflow chart, as described in “Define Events in a Chart” on page 11-2.
- 2 Set the **Scope** property for the event to **Input** from Simulink. A single trigger port appears at the top of the Stateflow block in the Simulink model.
- 3 An input event can activate a Stateflow chart through a change in a control signal (an edge trigger) or a function call from a Simulink block.
 - To specify an edge-triggered input event, set the **Trigger** property to one of these options:
 - Rising
 - Falling
 - Either
 - To specify a function-call input event, set the **Trigger** property to **Function call**.

You cannot mix edge-triggered and function-call input events in the same Stateflow chart. Mixing these input events results in an error during parsing and simulation.

For more information, see “Synchronize Model Components by Broadcasting Events” on page 11-2.

Activate a Stateflow Chart by Using Edge Triggers

An edge-triggered input event causes a Stateflow chart to execute during the current time step of simulation. With this type of input event, a change in a control signal acts as a trigger.

Edge Trigger Type	Description
Rising	Rising edge trigger. Chart is activated when the control signal changes from either zero or a negative value to a positive value.
Falling	Falling edge trigger. Chart is activated when the control signal changes from a positive value to either zero or a negative value.
Either	Either rising or falling edge trigger. Chart is activated when the control signal crosses zero as it changes in either direction.

In all cases, the value of the control signal must cross zero to be a valid edge trigger. For example, a signal that changes from -1 to 1 is a valid rising edge trigger. A signal that changes from 1 to 2 is not a valid rising edge trigger.

When to Use an Edge-Triggered Event

Use an edge-triggered input event to activate a chart when your model requires regular or periodic chart execution. For example, in the model `sf_loop_scheduler`, an edge-triggered input event activates the Edge to Function chart at regular intervals. For more information, see “Schedule a Subsystem Multiple Times in a Single Step” on page 27-14.

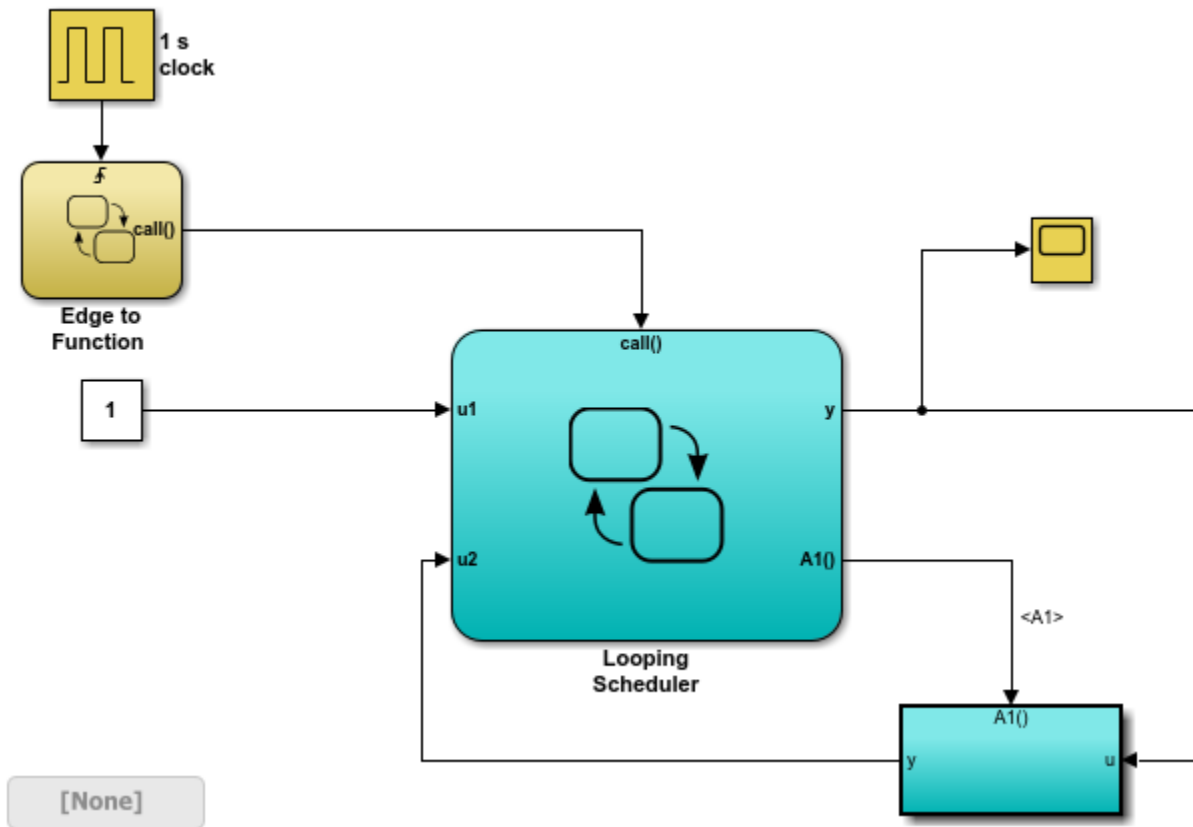

Behavior of Multiple Edge-Triggered Input Events

At any given time step, input events are checked in ascending order based on their port numbers. The chart awakens once for each valid event. For edge-triggered input events, multiple edges can occur in the same time step, waking the chart more than once in that time step. In this situation, the events wake the chart in ascending order based on their port numbers.

Activate a Stateflow Chart by Using Function Calls

A function-call input event causes a Stateflow chart to execute during the current time step of simulation. With this type of input event, you must also define a function-call output event for the block that calls the Stateflow chart.

When to Use a Function-Call Input Event

Use a function-call input event to activate a chart when your model requires access to output data from the chart in the same time step as the function call. For example, in the model `sf_loop_scheduler`, a function-call input event activates the Looping Scheduler chart. For more information, see “Schedule a Subsystem Multiple Times in a Single Step” on page 27-14.

Behavior of Multiple Function-Call Input Events

For function-call input events, only one trigger event exists. The caller of the event explicitly calls and executes the chart. Only one function call is valid in a single time step.

Association of Input Events with Control Signals

When you define one or more input events in a chart, a single trigger port appears on the top side of the chart block. Multiple external Simulink blocks can trigger the input events through a vector of signals connected to the trigger port. The **Port** property of an input event specifies the index into the control signal vector that connects to the trigger port.

By default, **Port** values appear in the order that you add input events. You can change these assignments by modifying the **Port** property of the events. When you change the **Port** property for an input event, the **Port** values for the remaining input events automatically renumber.

Data Types Allowed for Input Events

For multiple input events to a trigger port, all signals must have the same data type. Using signals of different data types as input events results in an error during simulation. For example, you can mux two input signals of type `double` to use as input events to a chart.

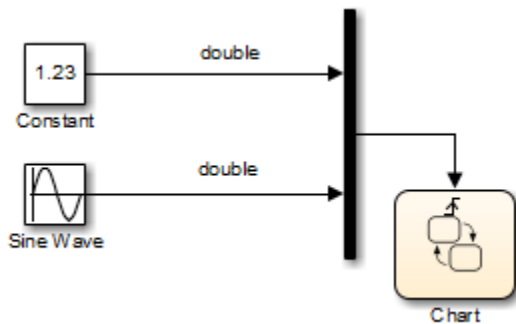

You cannot mux two input signals of different data types, such as `boolean` and `double`.

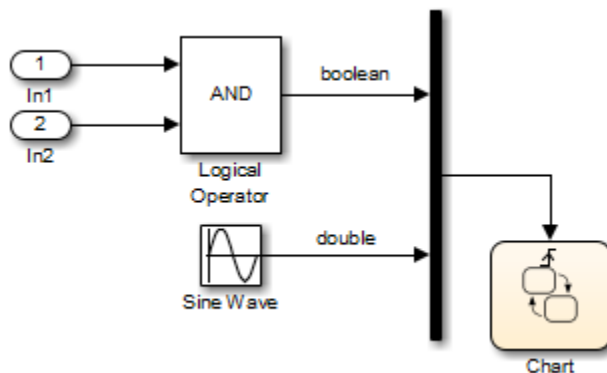

See Also

More About

- “Synchronize Model Components by Broadcasting Events” on page 11-2
- “Set Properties for an Event” on page 11-5

- “Control States in Charts Enabled by Function-Call Input Events” on page 11-11
- “Schedule a Subsystem Multiple Times in a Single Step” on page 27-14
- “View Differences Between Stateflow Messages, Events, and Data” on page 12-23

Control States in Charts Enabled by Function-Call Input Events

In a Simulink® model, when a Stateflow® chart is enabled by a function-call input event, you can control the state of the chart by setting the **States When Enabling** chart property. This property determines the values of states and data when the input event reenables the chart:

- Held — Maintain most recent values of the states and data.
- Reset — Revert to the initial values of the states and data.

For new charts, the default setting is Held. For more information, see “Activate a Stateflow Chart by Sending Input Events” on page 11-7.

Example of a Chart Enabled by a Function-Call Input Event

In this model, the Caller chart uses the event E to wake up and execute the Callee chart.

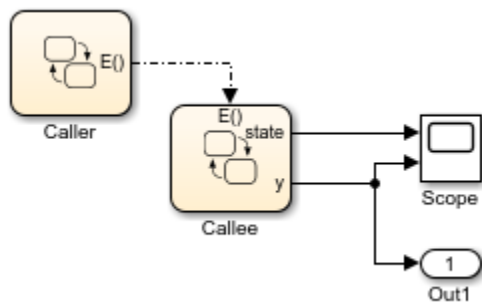

The Caller chart contains two states, A and B. When you bind the output event E in state A:

- Entering A enables the Callee chart.
- Exiting A disables the Callee chart.
- Reentering A reenables the Callee chart.

The temporal logic operator `after` changes the active state every ten time steps, so the Callee chart is repeatedly enabled and disabled.



The Callee chart contains two states, C and D. Each time that the chart executes, the output data `y` increments by one. The state C is initially active. After one time step, the value of `y` is positive and the chart takes the transition to state D.

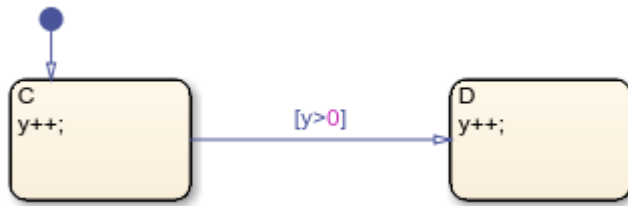

Chart Simulation When Property Is Held

In the Callee chart, the **States When Enabling** property is set to Held. During simulation, when the function-call input event reenables the chart at times $t = 20$ and $t = 40$, state D stays active and output y maintains its most recent value.

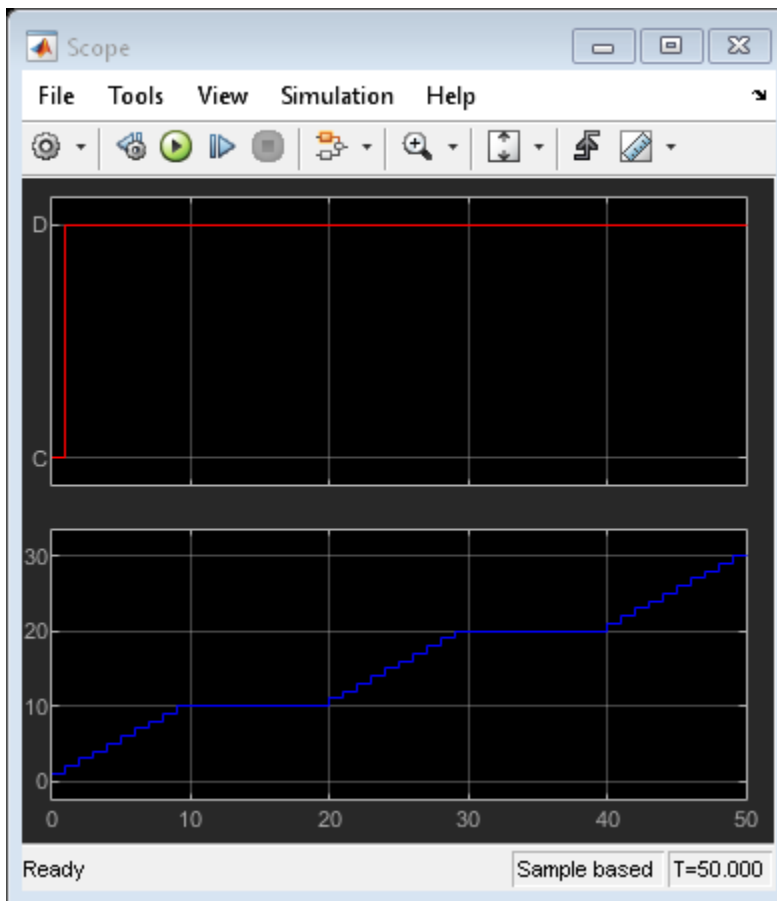
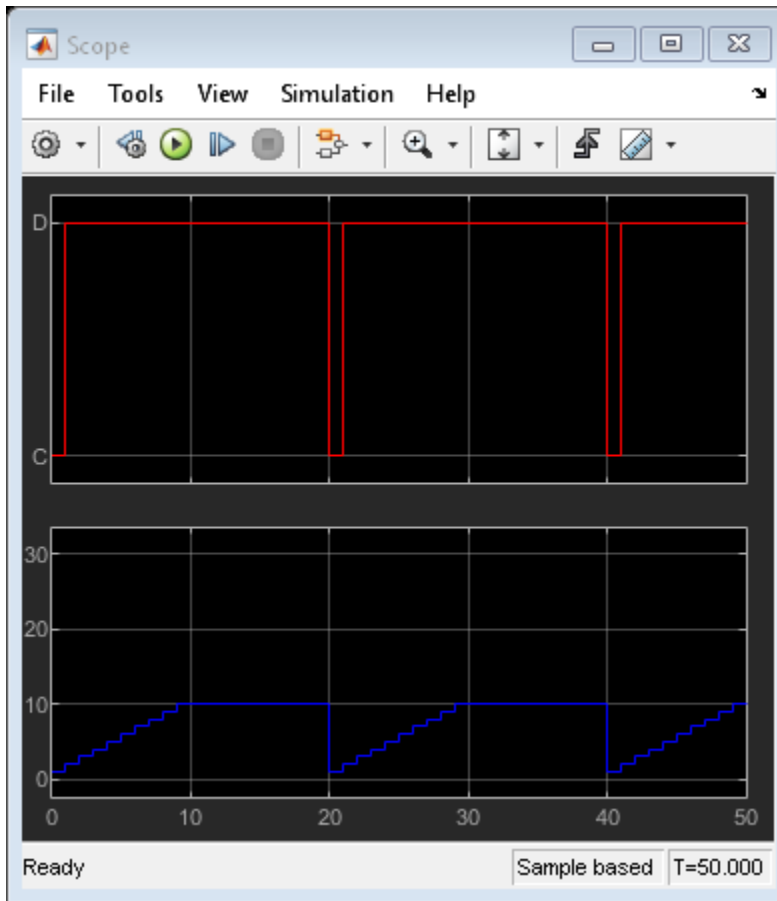

Chart Simulation When Property is Reset

In the Callee chart, change the **States When Enabling** property to Reset. During simulation, when the function-call input event reenables the chart at times $t = 20$ and $t = 40$, state C becomes active and output y reverts to its initial value of zero.



See Also

More About

- “Synchronize Model Components by Broadcasting Events” on page 11-2
- “Activate a Stateflow Chart by Sending Input Events” on page 11-7
- “Model References” (Simulink)

Activate a Simulink Block by Sending Output Events

An output event is an event that occurs in a Stateflow chart but is visible in Simulink blocks outside the chart. This type of event enables a chart to notify other blocks in a model about events that occur in the chart. To define an output event:

- 1 Add an event to the Stateflow chart, as described in “Define Events in a Chart” on page 11-2.
- 2 Set the **Scope** property for the event to **Output to Simulink**. For each output event that you define, an output port appears on the Stateflow block.
- 3 An output event can activate other blocks in the model through a change in a control signal (an edge trigger) or a function call to a Simulink block.
 - To specify an edge-triggered output event, set the **Trigger** property to **Either Edge**.
 - To specify a function-call output event, set the **Trigger** property to **Function call**.

For more information, see “Synchronize Model Components by Broadcasting Events” on page 11-2.

Activate a Simulink Block by Using Edge Triggers

An edge-triggered output event activates a Simulink block to execute during the current time step of simulation. With this type of output event, a change in a control signal acts as a trigger. For more information, see “Using Triggered Subsystems” (Simulink).

When to Use Edge-Triggered Output Events

To activate a Simulink subsystem when your model requires regular or periodic subsystem execution, use an edge-triggered output event. For example, this model uses an edge-triggered output event to activate two triggered subsystems at regular intervals.

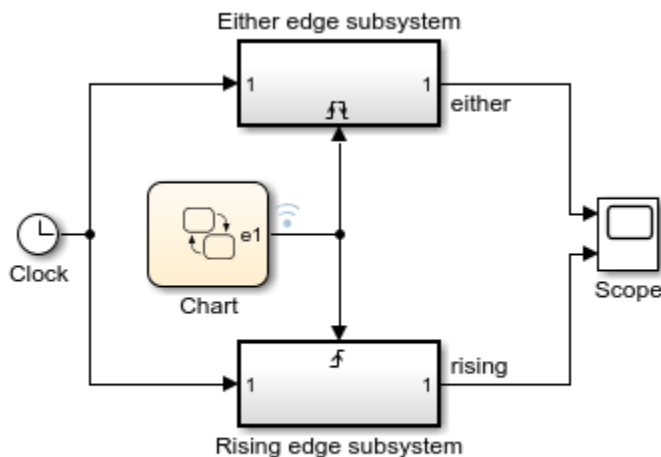

Copyright 2010-2018 The MathWorks, Inc.

The chart contains the edge-triggered output event e1 which alternates between 0 and 1 during simulation.

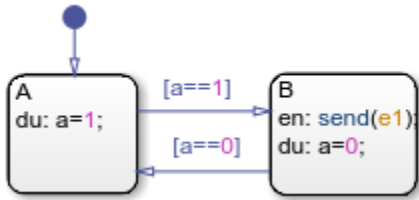

In a Stateflow chart, the **Trigger** property of an edge-triggered output event is always **Either Edge**. Simulink triggered subsystems can have a **Rising**, **Falling**, or **Either** edge trigger. The model shows the difference between triggering an **Either** edge subsystem from a **Rising** edge subsystem:

- The output event triggers the **Either** edge subsystem on every broadcast. The trigger occurs when the event signal switches from 0 to 1 or from 1 to 0.
- The output event triggers the **Rising** edge subsystem on every other broadcast. The trigger occurs only when the event signal switches from 0 to 1.

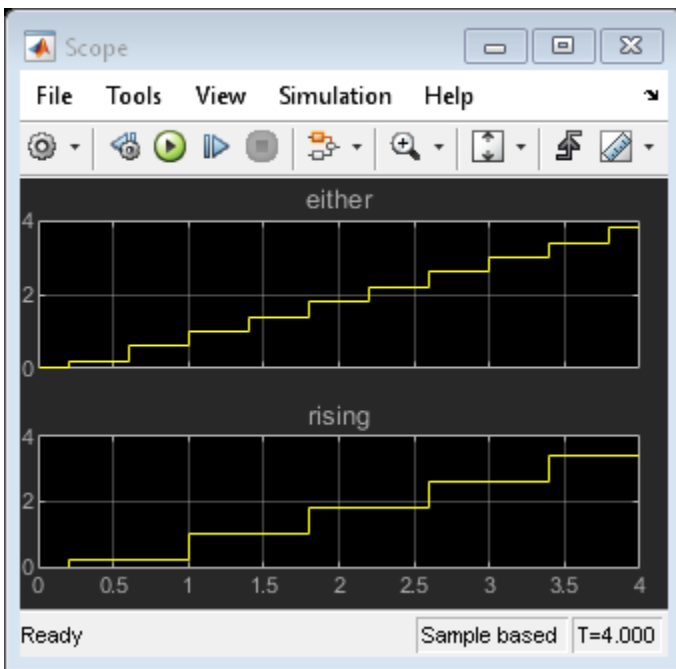

Queuing Behavior of Multiple Edge-Triggered Output Events

A chart dispatches only one broadcast of an edge-triggered output event for each time step. When there are multiple broadcasts in a single time step, the chart dispatches one broadcast and queues up the remaining broadcasts for dispatch in successive time steps. For example, in this model, the Caller chart uses the edge-triggered output event `output_cmd` to activate the Callee chart.

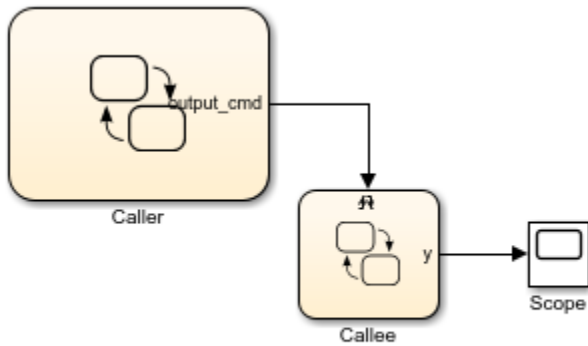

Copyright 2018 The MathWorks, Inc.

The Caller chart tries to broadcast the same edge-triggered output event four times in a single time step.

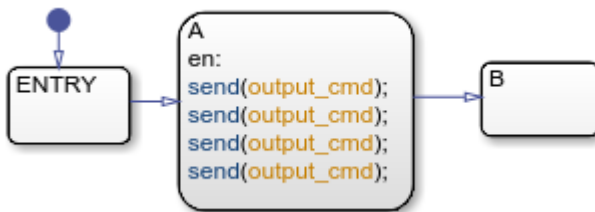

Each time the Callee chart is activated, the output data y increments by one.



When you simulate the model, at time $t = 1$, the Caller chart dispatches one of the four output events. The Callee chart executes once during that time step. The Caller chart queues up the other three event broadcasts for future dispatch at a time $t = 2$, $t = 3$, and $t = 4$. As a result, the value of y grows in increments of one at time $t = 1$, $t = 2$, $t = 3$, and $t = 4$.

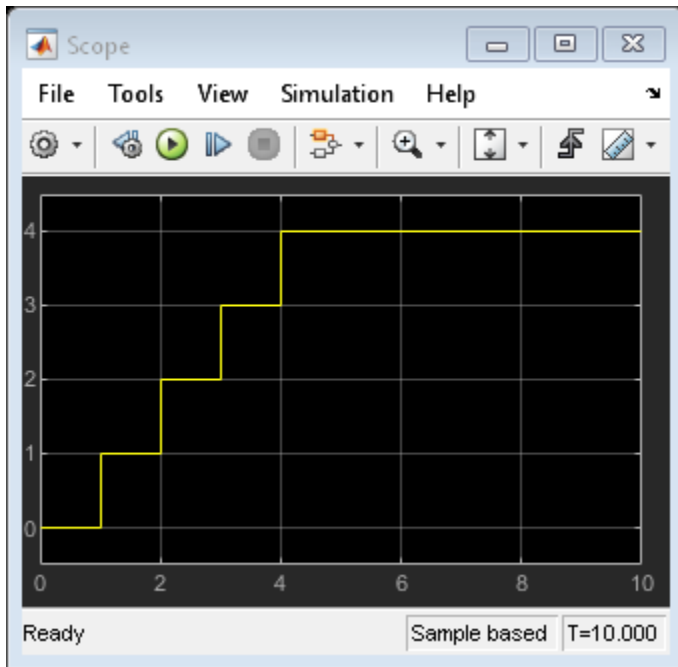

Activate a Simulink Block by Using Function Calls

A function-call output event activates a Simulink block to execute during the current time step of simulation. This type of output event works only on blocks that you can trigger with a function call. For more information, see “Using Function-Call Subsystems” (Simulink).

When to Use Function-Call Output Events

Use a function-call output event to activate a Simulink block when your model requires access to output data from the block in the same time step as the function call. For example, the model `sf_loop_scheduler` contains two function-call output events:

- In the Edge to Function chart, the output event `call` activates the Looping Scheduler chart.
- In the Looping Scheduler chart, the output event `A1` activates a Simulink subsystem.

For more information, see “Schedule a Subsystem Multiple Times in a Single Step” on page 27-14.

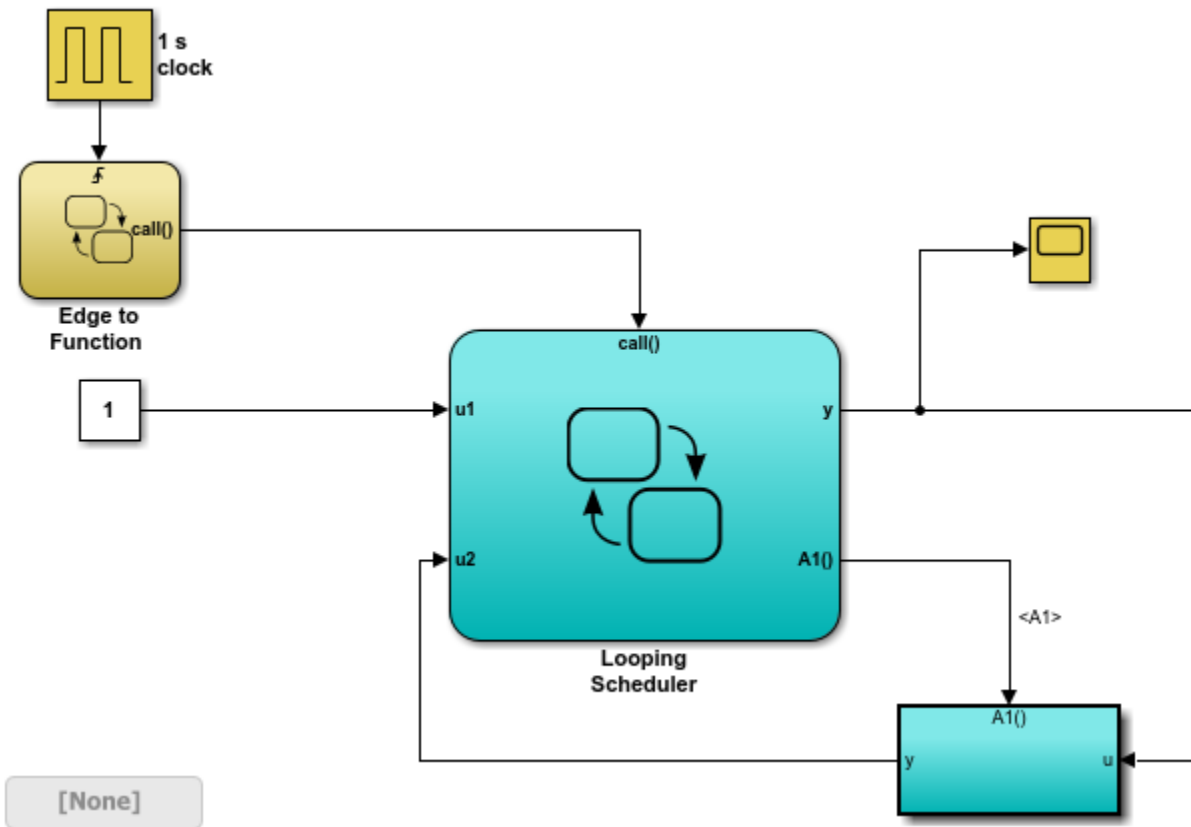

Interleaving Behavior of Multiple Function-Call Output Events

When there are multiple broadcasts of a function-call output event in a single time step, the chart dispatches all the broadcasts in that time step. Execution of function-call subsystems is interleaved with the execution of the chart, so that output from the function-call subsystem is available immediately in the chart. For example, in this model, the Caller chart uses the function-call output event `output_cmd` to activate the Callee chart.

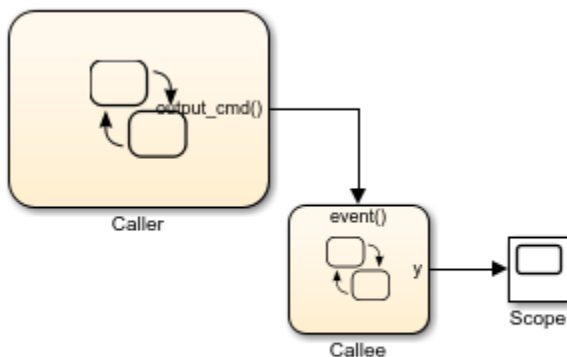

The Caller chart tries to broadcast the same function-call output event four times in a single time step.

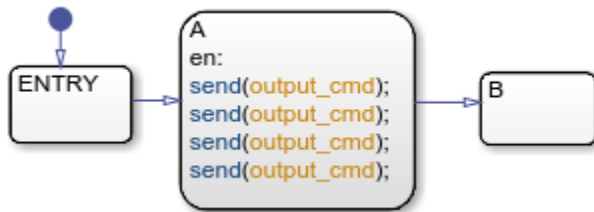

Each time the Callee chart is activated, the output data y increments by one.

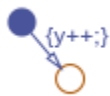

When you simulate the model, the Caller chart dispatches all four output events at time $t = 1$. The Callee chart executes four times during that time step. Execution of the Callee chart is interleaved with execution of the Caller chart so that output from the Callee chart is immediately available. As a result, the value of $|y|$ increases from 0 to 4 at time $t = 1$.

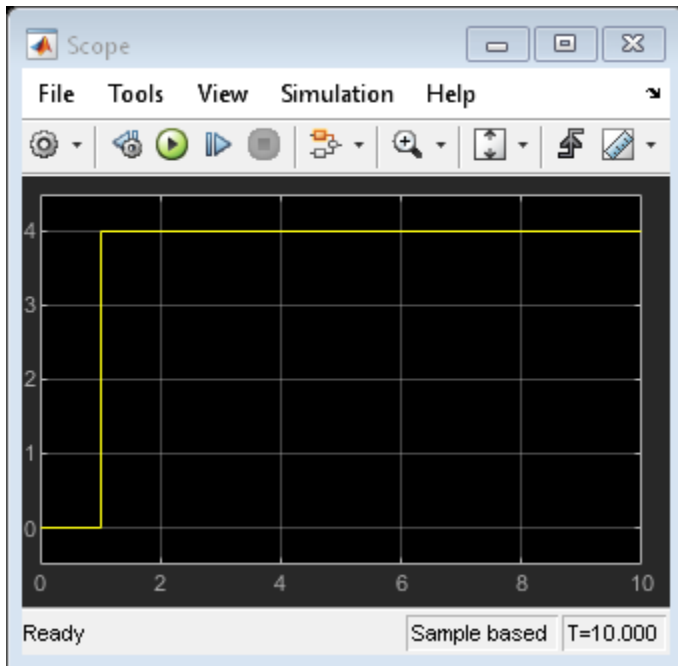

Approximate a Function Call by Using Edge-Triggered Events

If you cannot use a function-call output event, such as for HDL code generation, you can approximate a function call by using:

- An edge-triggered output event

- An enabled subsystem
- Two consecutive event broadcasts

The queuing behavior of consecutive edge-triggered output events enables you to approximate a function call with an enabled subsystem.

For example, in this model, the edge-triggered output event `output_cmd` activates the enabled subsystem.

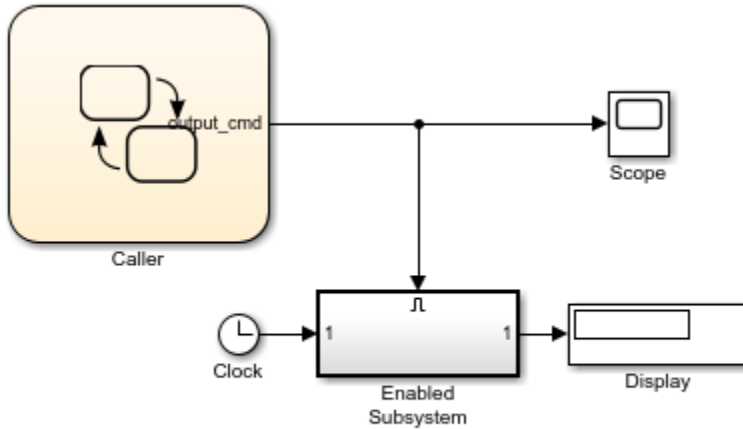

Copyright 2018 The MathWorks, Inc.

The Caller chart broadcasts the edge-triggered output event by using the send operator.

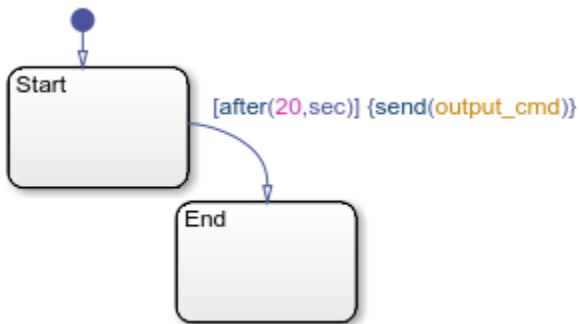

When simulation starts, the value of the trigger signal is 0. At time $t = 20$, the chart dispatches `output_cmd`, changing the value of the trigger signal to 1. The enabled subsystem becomes active and executes during that time step. Because no other event broadcasts occur, the enabled subsystem continues to execute at every time step until simulation ends at $t = 40$. The Display block shows a final value of 40.

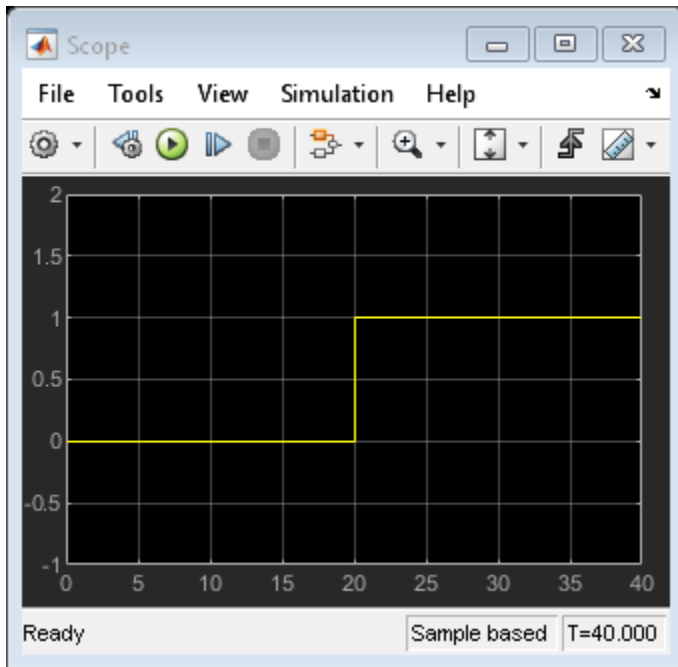

To approximate a function call, add a second event broadcast in the same action.

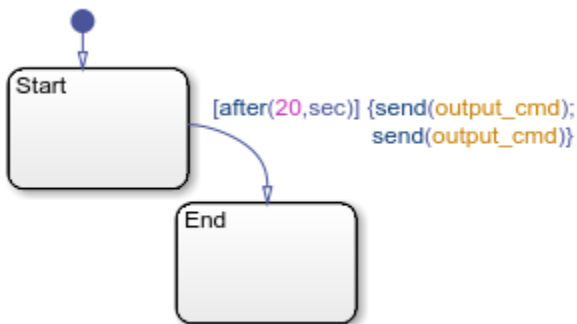

When simulation starts, the value of the trigger signal is 0. At time $t = 20$, the chart dispatches `output_cmd`, changing the value of the trigger signal to 1. The enabled subsystem becomes active and executes during that time step. The chart queues up the second event for dispatch at the next time step. At time $t = 21$, the chart dispatches the second output event, which changes the value of the trigger signal back to 0. The enabled subsystem stops executing and the Display block shows a final value of 20.

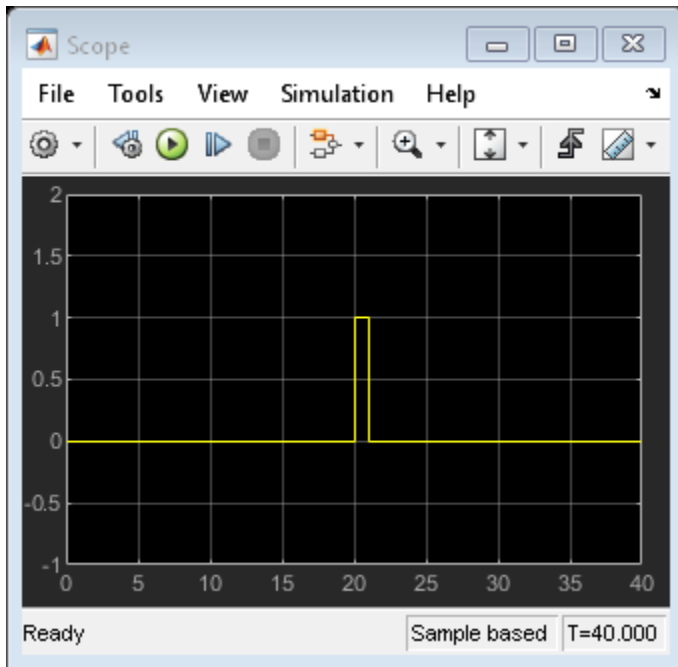

Although you can approximate a function call, there is a subtle difference in execution behavior. Execution of a function-call subsystem occurs *during* execution of the chart action that provides the trigger. Execution of an enabled subsystem occurs *after* execution of the chart action is complete.

Association of Output Events with Output Ports

When you define an output event in a chart, an output event port appears on the right side of a chart block. Output events must be scalar, but you can define multiple output events in a chart. The **Port** property of an output event specifies the position of the output port.

By default, **Port** values appear in the order in which you add output events. You can change these assignments by modifying the **Port** property of the events. When you change the **Port** property for an output event, the **Port** values for the remaining output events automatically renumber.

See Also

send

More About

- “Synchronize Model Components by Broadcasting Events” on page 11-2
- “Set Properties for an Event” on page 11-5
- “Schedule a Subsystem Multiple Times in a Single Step” on page 27-14
- “View Differences Between Stateflow Messages, Events, and Data” on page 12-23
- “Using Triggered Subsystems” (Simulink)
- “Using Function-Call Subsystems” (Simulink)

Control Chart Behavior by Using Implicit Events

Implicit events are built-in events that occur during chart execution when:

- The chart wakes up.
- The chart enters a state and the state becomes active.
- The chart exits a state and the state becomes inactive.
- The chart assigns a value to an internal data object.

These events are implicit because you do not define or trigger them explicitly. Implicit events are children of the chart in which they occur and are visible only in the parent chart.

Implicit Events Based on Chart Execution

The keyword `tick` specifies the implicit event generated when a chart wakes up in a discrete-time simulation.

For example, in this chart, `Fan` and `Heater` are parallel (AND) states. Each state has a pair of substates, `On` and `Off`. Initially, the substates `Fan.Off` and `Heater.Off` are active. Each time the chart wakes up, it generates a `tick` event. The third `tick` triggers the transition from `Heater.Off` to `Heater.On`. Similarly, the fourth `tick` triggers the transition from `Fan.Off` to `Fan.On`. On the eighth `tick`, the chart transitions back to `Fan.Off` and `Heater.Off`.

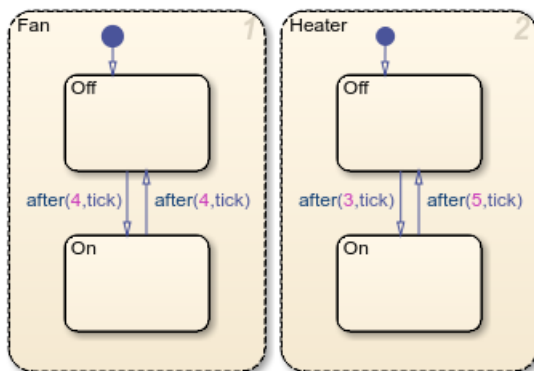

For information about the temporal logic operator `after`, see “Control Chart Execution by Using Temporal Logic” on page 13-40.

Note The `tick` event refers to the chart containing the action being evaluated. The event cannot refer to a different chart.

Implicit Events Based on Data and States

In Stateflow charts in Simulink models, these operators generate implicit events when a chart sets the value of a variable or when a chart enters or exits a state.

Operator	Syntax	Description	Example
change	<pre>change(<i>data_name</i>) chg(<i>data_name</i>)</pre>	Generates an implicit local event when the chart sets the value of the variable <i>data_name</i> . The variable <i>data_name</i> cannot be machine-parented data. This implicit event works only with data that is at the chart level or lower in the hierarchy. For machine-parented data, use change detection operators to determine when the data value changes. For more information, see “Detect Changes in Data Values” on page 13-56.	Define an implicit local event when a state or transition action writes a value to the variable <code>Engine.rpm</code> . <pre>change(Engine.rpm)</pre>
enter	<pre>enter(<i>state_name</i>) en(<i>state_name</i>)</pre>	Generates an implicit local event when the specified state <i>state_name</i> becomes active.	Define an implicit local event when the chart execution enters the state <code>Switch.On</code> . <pre>enter(Switch.On)</pre>
exit	<pre>exit(<i>state_name</i>) ex(<i>state_name</i>)</pre>	Generates an implicit local event when the specified state <i>state_name</i> becomes inactive.	Define an implicit local event when the chart execution exits the state <code>Switch.Off</code> . <pre>exit(Switch.Off)</pre>

If more than one state or data object has the same name, use dot notation to qualify the name of the state. For more information, see “Identify Data by Using Dot Notation” on page 9-39.

For example, in this chart, Fan and Heater are parallel (AND) states. Each state has a pair of substates, On and Off. Initially, the substates `Fan.Off` and `Heater.Off` are active. When the chart wakes up, it generates a `tick` event that triggers the transition from `Fan.Off` to `Fan.On`. When the `Fan.Off` becomes inactive, the chart generates another implicit event that triggers the transition from `Heater.Off` to `Heater.On`. When the chart execution ends, the substates `Fan.On` and `Heater.On` are active.

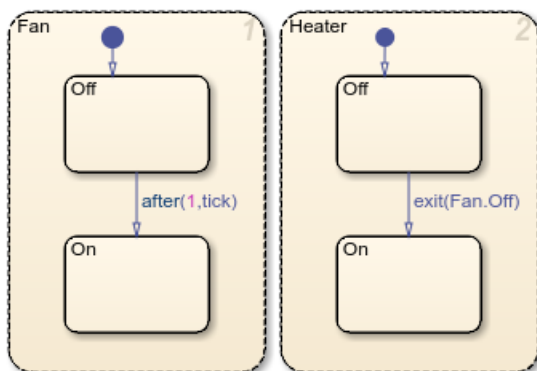

Note If the same implicit event triggers multiple transitions in parallel states, the order in which the transitions execute does not necessarily match the execution order of the parallel states. To avoid unexpected behavior and ensure that the transitions execute in the order specified for the parallel states, do not use implicit events. Instead, use transition conditions that call operators such as `in` or `hasChanged`. For more information, see “Check State Activity by Using the `in` Operator” on page 10-14 and “Detect Changes in Data Values” on page 13-56.

See Also

after | change | enter | exit | hasChanged | in

More About

- “Use Events to Execute Charts” on page 3-51
- “Detect Changes in Data Values” on page 13-56
- “Check State Activity by Using the `in` Operator” on page 10-14
- “Control Chart Execution by Using Temporal Logic” on page 13-40

Count Events by Using the temporalCount Operator

You can count occurrences of explicit and implicit events by using the `temporalCount` operator. For more information, see “Temporal Logic Operators” on page 13-40.

Collect and Store Input Data in a Vector

This model collects and stores input data in a vector during chart simulation:

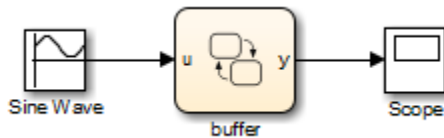

The chart contains two states and one MATLAB function:

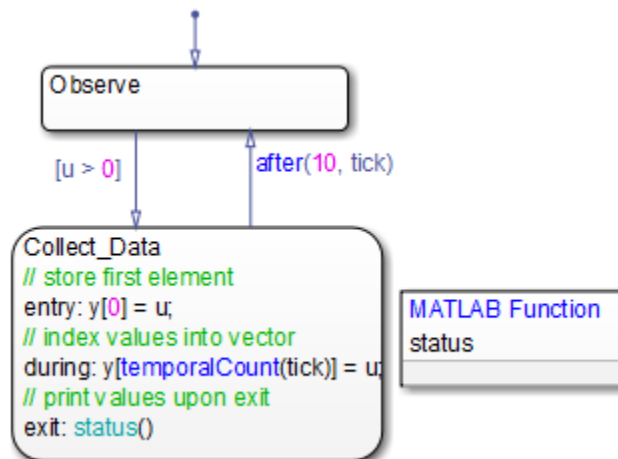

Stage 1: Observation of Input Data

The chart awakens and remains in the `Observe` state, until the input data `u` is positive. Then, the transition to the state `Collect_Data` occurs.

Stage 2: Storage of Input Data

After the state `Collect_Data` becomes active, the value of the input data `u` is assigned to the first element of the vector `y`. While this state is active, each subsequent value of `u` is assigned to successive elements of `y` using the `temporalCount` operator.

Stage 3: Display of Data Stored in the Vector

After 10 ticks, the data collection process ends, and the transition to the state `Observe` occurs. Just before the state `Collect_Data` becomes inactive, a function call to `status` displays the vector data at the MATLAB prompt.

For more information about ticks in a Stateflow chart, see “Control Chart Behavior by Using Implicit Events” on page 11-23.

Yo-Yo Control of Satellites

This example shows how to model the control system in a tethered satellite system. The satellite system consists of a small satellite attached by a long tether to an orbiting platform. When the tethered satellite oscillates, it behaves like a pendulum that exhibits too much libration. To stabilize the pendulum, the control system changes the length of the tether by reeling it out to its maximum length when the satellite is in the middle of its arc (which decreases its angular acceleration) and by reeling it in when the satellite has an angular velocity equal to zero.

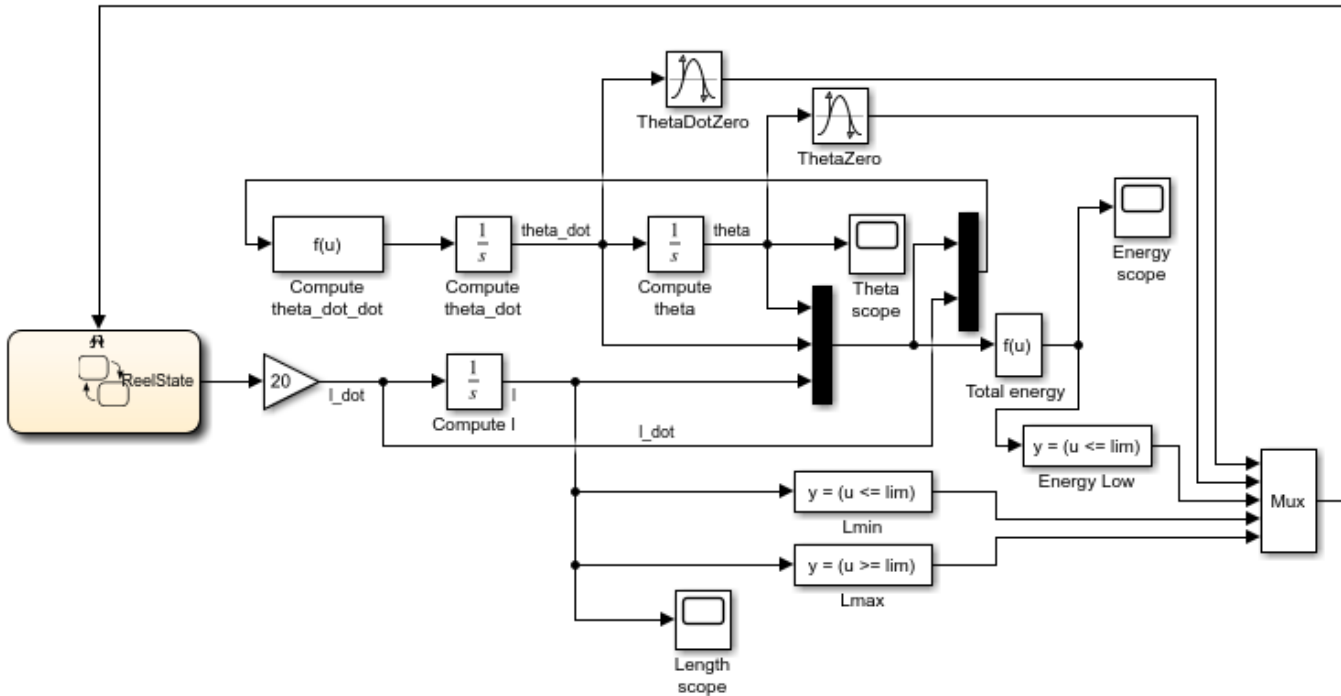

Stateflow® is used to control when the tether is reeled in or reeled out using input events from Simulink®. When the satellite is in the middle of its swing ($\theta = 0$), the state ReelOut becomes active. When the satellite has been reeled out as far as it can, the state ReelStop becomes active. When the angular velocity of the satellite reaches zero, the ReelIn state becomes active. When the tether is as short as possible, the ReelStop state becomes active once again. Finally, if the total energy of the satellite is too low, the system is deactivated by entering the Inactive state.

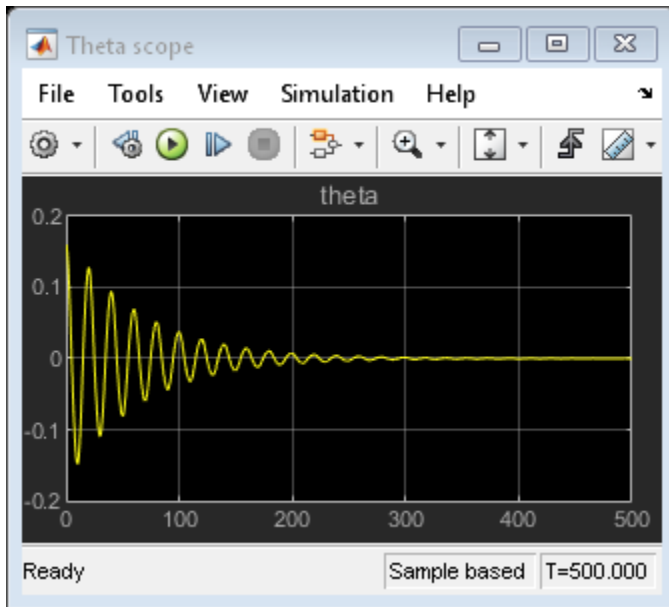
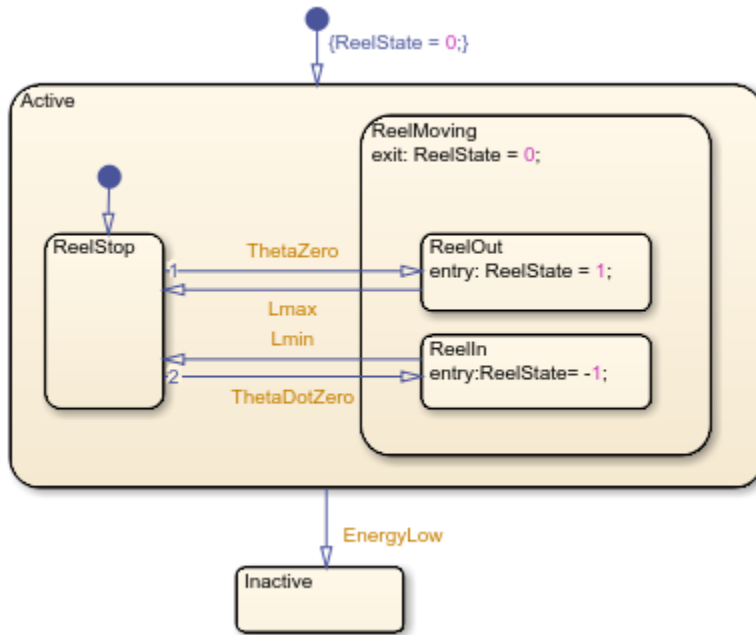

Reference

Dabney, James B. and Harman, Thomas L. *Mastering Simulink*, 2003.

See Also

More About

- “Synchronize Model Components by Broadcasting Events” on page 11-2

Messages

- “Communicate with Stateflow Charts by Sending Messages” on page 12-2
- “Set Properties for a Message” on page 12-5
- “Control Message Activity in Stateflow Charts” on page 12-9
- “Use the Sequence Viewer Block to Visualize Messages, Events, and Entities” on page 12-14
- “View Differences Between Stateflow Messages, Events, and Data” on page 12-23
- “Model a Distributed Traffic Control System by Using Messages” on page 12-29

Communicate with Stateflow Charts by Sending Messages

To communicate within and between Stateflow charts in a Simulink model, use messages. A message is a Stateflow object that communicates data locally or between charts. From a sender chart, you can send or forward a message containing data. In the receiving chart, a queue receives the message and holds it until the chart can evaluate it.



Messages combine some of the functionality of data and events. Like data, messages can transmit numeric and textual information. Like events, messages can trigger transition and state actions. However:

- Messages do not trigger charts to wake up. Instead, messages are queued until the chart wakes up. When the chart wakes up, it can respond to the messages in the queue.
- Messages are not lost if the receiver chart cannot respond immediately.

For more information, see “View Differences Between Stateflow Messages, Events, and Data” on page 12-23.

When a chart transition or state action evaluates a message, the chart determines if the queue contains any messages. If it does, the chart removes the message from the queue. The message remains valid until the end of the time step or until the chart forwards or discards it. While the message is valid, other transitions or actions can access the message data and the chart does not remove another message from the queue. The chart destroys all valid messages at the end of the current time step.

Define Messages in a Chart

You can add messages to a Stateflow chart by using the Symbols pane, the Stateflow Editor menu, or the Model Explorer.

Add Messages Through the Symbols Pane

- 1 In the **Modeling** tab, under **Design Data**, select **Symbols Pane**.
- 2 Click the **Create Message** icon .
- 3 In the row for the new message, under **TYPE**, click the icon and choose:
 - Input Message
 - Local Message
 - Output Message
- 4 Edit the name of the message.
- 5 For input and output messages, click the **PORT** field and choose a port number.
- 6 To specify properties for the message, open the Property Inspector. In the Symbols pane, right-click the row for the message and select **Explore**. For more information, see “Set Properties for a Message” on page 12-5.

Add Messages by Using the Stateflow Editor Menu

- 1 In the Stateflow Editor, select the option corresponding to the scope of the message that you want to add.

Scope	Option
Input	In the Modeling tab, under Design Data , select Message Input .
Output	In the Modeling tab, under Design Data , select Message Output .
Local	In the Modeling tab, under Design Data , select Message .

- 2 In the Message dialog box, specify data properties. For more information, see “Set Properties for a Message” on page 12-5.

Add Messages Through the Model Explorer

- 1 In the **Modeling** tab, under **Design Data**, select **Model Explorer**.
- 2 In the **Model Hierarchy** pane, select the object in the Stateflow hierarchy where you want to make the new message visible. The object that you select becomes the parent of the new message.
- 3 In the Model Explorer menu, select **Add > Message**. The new message with a default definition appears in the **Contents** pane of the Model Explorer.
- 4 In the **Message** pane, specify the properties of the message. For more information, see “Set Properties for a Message” on page 12-5.

Lifetime of a Stateflow Message

A Stateflow message has a finite lifetime. The lifetime begins when you send a message to a receiving queue with the `send` operator. The message remains in the queue until a transition or state on action evaluates it or the chart receives it by using the `receive` operator.

A message becomes valid when a chart evaluates or receives it. The message remains valid until:

- The end of the current time step, when the chart destroys any remaining valid messages.
- The chart forwards the message to another queue by using the `forward` operator. The message continues its lifetime in the new queue.
- The chart discards the message by using the `discard`.

While a message is valid, other transitions and actions can evaluate the message and access its data. To check if a message is valid, use the `isvalid` operator.

To view the interchange of messages during simulation, add a Sequence Viewer block to your Simulink model. The Sequence Viewer block displays:

- Sent messages
- Received messages
- Forwarded messages
- Dropped messages
- Destroyed messages
- Discarded messages

For more information, see “Use the Sequence Viewer Block to Visualize Messages, Events, and Entities” on page 12-14.

Limitations for Messages

You cannot use messages in:

- Moore charts
- Atomic subcharts
- Breakpoint condition expressions
- Model reference inputs and outputs

In charts that use C as the action language, messages do not support multiword fixed-point data or data of type `int64` and `uint64`.

See Also

Queue | Sequence Viewer | discard | forward | invalid | receive | send

More About

- “Set Properties for a Message” on page 12-5
- “Control Message Activity in Stateflow Charts” on page 12-9
- “Send Messages with String Data” on page 21-10
- “Use the Sequence Viewer Block to Visualize Messages, Events, and Entities” on page 12-14

Set Properties for a Message

A message is a Stateflow object that communicates data locally or between charts in a Simulink model. For more information, see “Communicate with Stateflow Charts by Sending Messages” on page 12-2.

You can specify message properties in either the Property Inspector or the Model Explorer.

- To use the Property Inspector:
 - 1 In the **Modeling** tab, under **Design Data**, select **Symbols Pane** and **Property Inspector**.
 - 2 In the Symbols pane, select the message.
 - 3 In the Property Inspector pane, edit the message properties.
- To use the Model Explorer:
 - 1 In the **Modeling** tab, under **Design Data**, select **Model Explorer**.
 - 2 In the **Contents** pane, select the message.
 - 3 In the **Message** pane, edit the message properties.

For more information, see “Communicate with Stateflow Charts by Sending Messages” on page 12-2.

Stateflow Message Properties

Name

Name of the message. For more information, see “Rules for Naming Stateflow Objects” on page 2-5.

Scope

Scope of the message. The scope specifies where the message occurs relative to the parent object.

Scope	Description
Input	Message that is received from another block in the Simulink model. Each input message can use an internal receiving queue that is maintained by the Stateflow chart or an external receiving queue that is managed by a Queue block.
Output	Message that is sent through an output port to another block in the Simulink model.
Local	Message that is local to the Stateflow chart. The Stateflow chart maintains an internal receiving queue for each local message. When you send a local message, it is visible by state and transition actions in the same chart. You cannot send a local message outside the chart.

Port

Index of the port associated with the message. This property applies only to input and output messages.

Size

Size of the message data field. For more information, see “Specify Size of Stateflow Data” on page 9-33.

Complexity

Specifies whether the message data field accepts complex values.

Complexity Setting	Description
Off	Data field does not accept complex values.
On	Data field accepts complex values.
Inherited	Data field inherits the complexity setting from a Simulink block.

The default value is *Off*. For more information, see “Complex Data in Stateflow Charts” on page 24-2.

Type

Type of the message data field. To specify the data type:

- From the **Type** drop-down list, select a built-in type.
- In the **Type** field, enter an expression that evaluates to a data type.

Additionally, in the Model Explorer, you can open the Data Type Assistant by clicking the **Show data type assistant** button . Specify a data **Mode**, and then specify the data type based on that mode. For more information, see “Specify Type of Stateflow Data” on page 9-27.

Note In charts that use C as the action language, messages do not support multiword fixed-point data or data of type `int64` and `uint64`.

Initial Value

Initial value of the message data. Enter an expression or parameter defined in the Stateflow hierarchy, MATLAB base workspace, or Simulink masked subsystem. This property applies only to local and output messages.

If you do not specify a value, the default value for numeric data is 0. For enumerated data, the default value typically is the first one listed in the `enumeration` section of the definition. You can specify a different default enumerated value in the `methods` section of the definition. For more information, see “Define Enumerated Data Types” on page 20-5.

Allow Initial Value to Resolve to a Parameter

Specifies that the message data inherits its initial value from a Simulink parameter in the MATLAB base workspace. This property applies only to local and output messages. For more information, see “Initialize Data from the MATLAB Base Workspace” on page 9-19.

Add to Watch Window

Enables watching the message queue and data field in the Stateflow Breakpoints and Watch window. For more information, see “View Data in the Breakpoints and Watch Window” on page 33-11.

Message Queue Properties

These properties define the behavior of receiving queues and apply only to input and local messages.

Use Internal Queue

Specifies that the Stateflow chart maintains an internal receiving queue for the input message. By default, this property is enabled. When you disable this property, you can connect the message input port to:

- A Queue block that manages an external queue in your Simulink model
- A root-level Inport block that enables messages to cross the model boundary

For more information on external message queues, see “Messages” (Simulink).

Queue Capacity

Specifies the maximum number of messages held in an internal receiving queue. If a chart sends a message when the queue is full, a queue overflow occurs. To avoid dropped messages, set the queue capacity high enough that incoming messages do not cause the queue to overflow. The maximum queue capacity is $2^{16}-1$.

Queue Overflow Diagnostic

Specifies the level of diagnostic action when the number of incoming messages exceeds the queue capacity. The default option is Error.

Diagnostic Setting	Description
Error	When the queue overflows, the simulation stops with an error.
Warning	When the queue overflows, the queue drops the last message and simulation continues with a warning.
None	When the queue overflows, the queue drops the last message and simulation continues without issuing a warning.

Queue Type

Specifies the order in which messages are removed from the receiving queue. The default option is FIFO.

Queue Type Setting	Description
FIFO	First in, first out
LIFO	Last in, first out
Priority	Remove messages according to the value in the data field. Choosing this setting exposes the Priority order field, which has these options: <ul style="list-style-type: none"> • Ascending — The messages are removed in ascending order of the message data value. • Descending — The messages are removed in descending order of the message data value.

See Also

Queue

More About

- “Communicate with Stateflow Charts by Sending Messages” on page 12-2
- “Rules for Naming Stateflow Objects” on page 2-5
- “Specify Size of Stateflow Data” on page 9-33
- “Specify Type of Stateflow Data” on page 9-27
- “Complex Data in Stateflow Charts” on page 24-2

Control Message Activity in Stateflow Charts

A message is a Stateflow object that communicates data locally or between charts in a Simulink model. From a sender chart, you can send or forward a message. In the receiving chart, a queue receives the message and holds it until the chart can evaluate it.

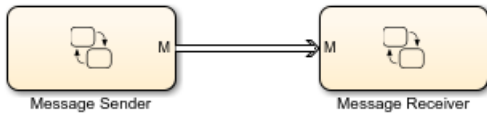

Using Stateflow operators, you can access message data, and send, receive, discard, or forward a message. You can also determine whether a message is valid and find the number of messages in a queue. For more information, see “Communicate with Stateflow Charts by Sending Messages” on page 12-2.

Access Message Data

Stateflow messages have a data field. To read or write to the message data field of a valid message, use dot notation syntax:

```
message_name.data
```

If you send a message without first assigning a value to the message data, the default value for numeric data is 0. For enumerated data, the default is the first value listed in the `enumeration` section of the definition, unless you specify otherwise in the `methods` section of the definition.

You cannot access message data for messages that are still in the queue or that have already been discarded.

Send a Message

To send an output or local message, use the send operator:

```
send(message_name)
```

For example, in this chart, the entry action in state A sends a message M with a data value of 3. If the message scope is `Local`, then the message goes in the local receiving queue. If the message scope is `Output`, then the chart sends the message through the output port to another block in the Simulink model.

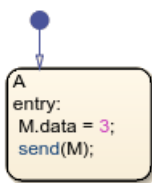

In a single time step, you can send multiple messages through an output port or to a local receiving queue.

If a chart sends a message that exceeds the capacity of the receiving queue, a queue overflow occurs. The result of the queue overflow depends on the type of receiving queue.

- When an overflow occurs in an internal queue, the Stateflow chart drops the new message. You can control the level of diagnostic action by setting the **Queue Overflow Diagnostic** property for the message. See “Queue Overflow Diagnostic” on page 12-7.
- When an overflow occurs in an external queue, the Queue block either drops the new message or overwrites the oldest message in the queue, depending on the configuration of the block. See “Overwrite the oldest element if queue is full” (Simulink). An overflow in an external queue always results in a warning.

Guard Transitions and Actions

Messages can guard transitions or state actions of type `on`. During a time step, when the guarding message is evaluated for the first time, the chart removes the message from the queue and makes the message valid. While the message is valid, other transitions or actions can access the message data but they do not remove another message from the queue.

Guard a Transition with a Message

In this chart, a message `M` guards the transition from state `A` to state `B`. The transition occurs when both of these conditions are true:

- A message is present in the queue.
- The data value of the message is equal to 3.

If a message is not present or if the data value is not equal to 3, then the transition does not occur. If a message is present, it is removed from the queue regardless of whether the transition occurs.

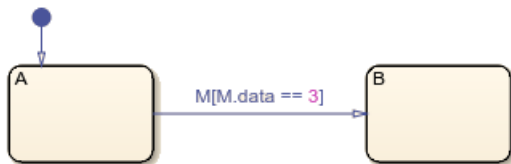

Guard a State on Action with a Message

In this chart, a message `M` guards the `on` action in state `A`. When state `A` becomes active, it increments the value of `x` if both of these conditions are true:

- A message is present in the queue.
- The data value of the message is equal to 3.

If a message is not present or if the data value is not equal to 3, then the value of `x` does not change. If a message is present, it is removed from the queue regardless of whether `x` is modified.

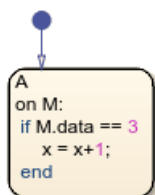

Receive a Message

To extract an input or local message from its receiving queue, use the `receive` operator:

```
receive(message_name)
```

If a valid message `M` exists, `receive(M)` returns `true`. If a valid message does not exist but there is a message in the queue, then the chart removes the message from the queue and `receive(M)` returns `true`. If a valid message does not exist and there are no messages in the queue, `receive(M)` returns `false`.

For example, in this chart, the `during` action in state `A` checks the queue for message `M` and increments the value of `x` if both of these conditions are true:

- A message is present in the queue.
- The data value of the message is equal to 3.

If a message is not present or if the data value is not equal to 3, then the value of `x` does not change. If a message is present, the chart removes it from the queue regardless of the data value.

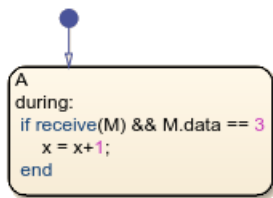

Discard a Message

To discard a valid input or local message, use the `discard` operator:

```
discard(message_name)
```

After a chart discards a message, it can remove another message from the queue in the same time step. A chart cannot access the data of a discarded message.

For example, in this chart, the `during` action in state `A` checks the queue for message `M`. If a message is present, the chart removes it from the queue. If the message has a data value equal to 3, the chart discards the message.

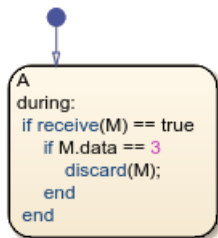

Forward a Message

To forward a valid input or local message to a local queue or an output port, use the `forward` operator:

```
forward(message_in_name,message_out_name)
```

After a chart forwards a message, it can remove another message from the queue in the same time step.

Forward an Input Message

In this chart, state A checks the input queue for message `M_in`. If a message is present, the chart removes the message from the queue and forwards it to the output port `M_out`. After the chart forwards the message, the message is no longer valid in state A.

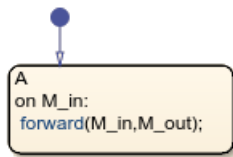

Forward a Local Message

In this chart, state A checks the input queue for message `M_in`. If a message is present, the chart forwards the message to the local message queue `M_local`. After a delay of 0.3 seconds, the transition from state A to state B removes the message from the `M_local` message queue and forwards it to the output port `M_out`.

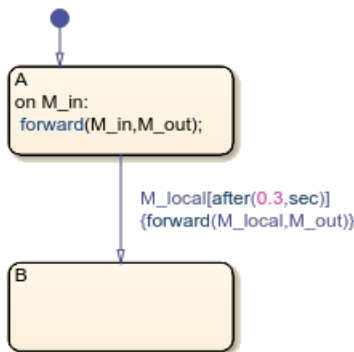

Determine if a Message Is Valid

To check if an input or local message is valid, use the `isvalid` operator:

```
isvalid(message_name)
```

A message is valid if the chart has removed it from the receiving queue and has not forwarded or discarded it.

For example, this chart first executes state A, as described in “Discard a Message” on page 12-11. When the chart executes state B, the `during` action checks that the message `M` is valid. If the message is valid and has a data value equal to 6, the chart discards the message.

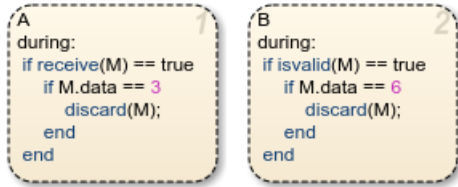

Determine the Length of the Queue

To check the number of messages in an internal receiving queue of an input or local message, use the `length` operator:

```
length(message_name)
```

For example, in this chart, the `during` action in state A checks the queue for message M. If a message is present, the chart removes it from the queue. If exactly seven messages remain in the queue, the chart increments the value of `x`.

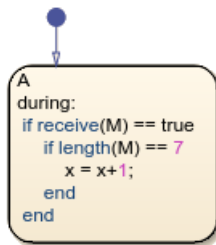

The `length` operator is not supported for input messages that use external receiving queues managed by a Queue block.

See Also

Queue | discard | forward | isvalid | length | receive | send

More About

- “Communicate with Stateflow Charts by Sending Messages” on page 12-2
- “Set Properties for a Message” on page 12-5
- “Use the Sequence Viewer Block to Visualize Messages, Events, and Entities” on page 12-14
- “View Differences Between Stateflow Messages, Events, and Data” on page 12-23

Use the Sequence Viewer Block to Visualize Messages, Events, and Entities

To see the interchange of messages and events between Stateflow charts in Simulink models and the movement of entities between SimEvents blocks, add a Sequence Viewer block to your Simulink model.

In the Sequence Viewer block, you can view event data related to Stateflow chart execution and the exchange of messages between Stateflow charts. The Sequence Viewer window shows messages as they are created, sent, forwarded, received, and destroyed at different times during model execution. The Sequence Viewer window also displays state activity, transitions, and function calls to Stateflow graphical functions, Simulink functions, and MATLAB functions.

With the Sequence Viewer block, you can visualize the movement of entities between blocks when simulating SimEvents models. All SimEvents blocks that can store entities appear as lifelines in the Sequence Viewer window. Entities moving between these blocks appear as lines with arrows. You can view calls to Simulink Function blocks and to MATLABFunction blocks.

You can add a Sequence Viewer block to the top level of a model or any subsystem. If you place a Sequence Viewer block in a subsystem that does not have messages, events, or state activity, the Sequence Viewer window informs you that there is nothing to display.

For instance, suppose that you simulate the Stateflow example `sf_msg_traffic_light`.

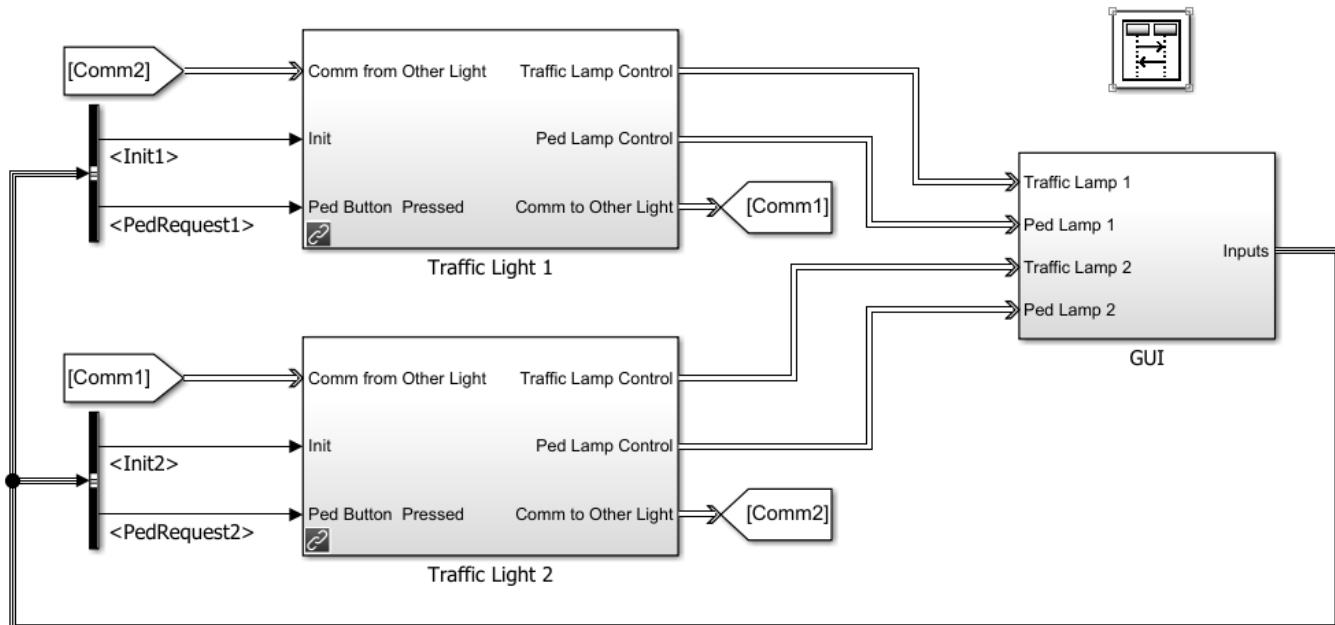

Copyright 2015, The MathWorks, Inc.



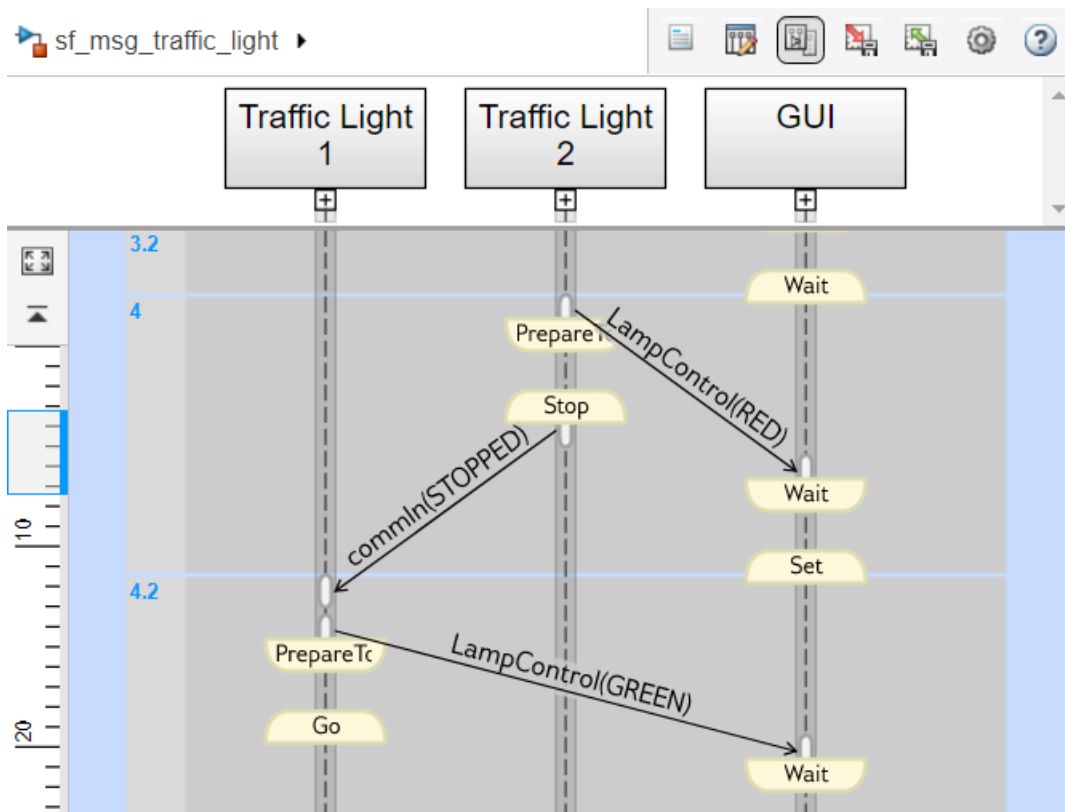



This model has three Simulink subsystems: Traffic Light 1, Traffic Light 2, and GUI. The Stateflow charts in these subsystems exchange data by sending messages. As messages pass through the system, you can view them in the Sequence Viewer window. The Sequence Viewer window represents each block in the model as a vertical lifeline with simulation time progressing downward.



Components of the Sequence Viewer Window

Navigation Toolbar

At the top of the Sequence Viewer window, a navigation toolbar displays the model hierarchy path. Using the toolbar buttons, you can:

-  Show or hide the Property Inspector.
-  Select an automatic or manual layout.
-  Show or hide inactive lifelines.
-  Save Sequence Viewer block settings.
-  Restore Sequence Viewer block settings.
-  Configure Sequence Viewer block parameters.
-  Access the Sequence Viewer block documentation.

Property Inspector

In the Property Inspector, you can choose filters to show or hide:

- Events

- Messages
- Function Calls
- State Changes and Transitions

Header Pane

The header pane below the Sequence Viewer toolbar shows lifeline headers containing the names of the corresponding blocks in a model.

- Gray rectangular headers correspond to subsystems.
- White rectangular headers correspond to masked subsystems.
- Yellow headers with rounded corners correspond to Stateflow charts.

To open a block in the model, click the name in the corresponding lifeline header. To show or hide a lifeline, double-click the corresponding header. To resize a lifeline header, click and drag its right-hand side. To fit all lifeline headers in the Sequence Viewer window, press the space bar.

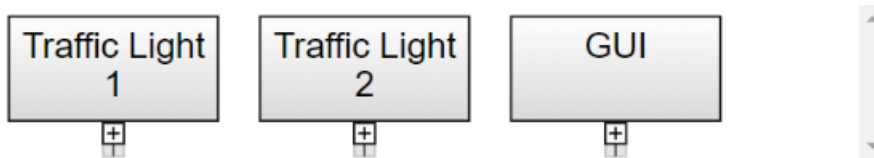
**Message Pane**

Below the header pane is the message pane. The message pane displays messages, events, and function calls between lifelines as arrows from the sender to the receiver. To display sender, receiver, and payload information in the Property Inspector, click the arrow corresponding to the message, event, or function call.

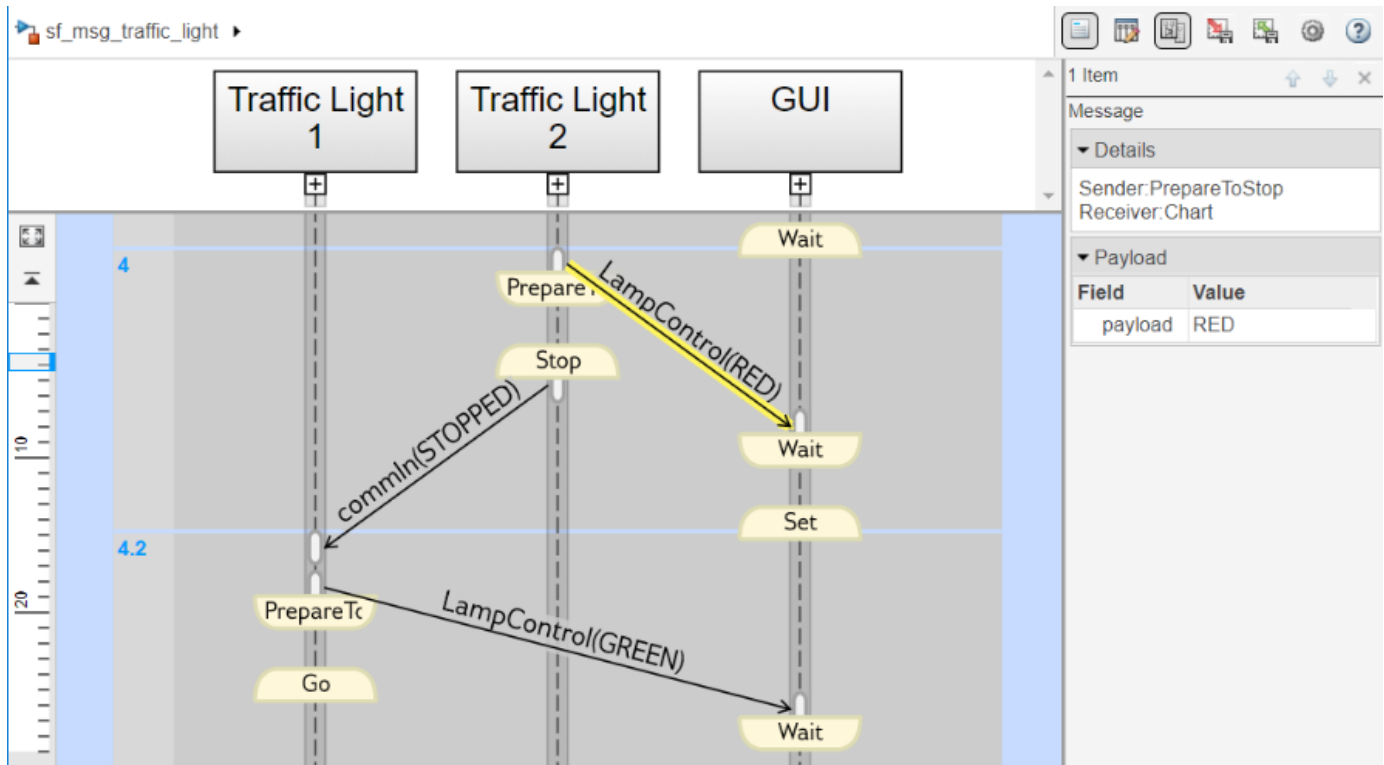

Navigate the Lifeline Hierarchy

In the Sequence Viewer window, the hierarchy of lifelines corresponds to the model hierarchy. When you pause or stop the model, you can expand or contract lifelines and change the root of focus for the viewer.

Expand a Parent Lifeline

In the message pane, a thick, gray lifeline indicates that you can expand the lifeline to see its children. To show the children of a lifeline, click the expander icon  below the header or double-click the parent lifeline.

For example, expanding the lifeline for the Traffic Light 1 block reveals two new lifelines corresponding to the Stateflow charts Ped Button Sensor and Controller.

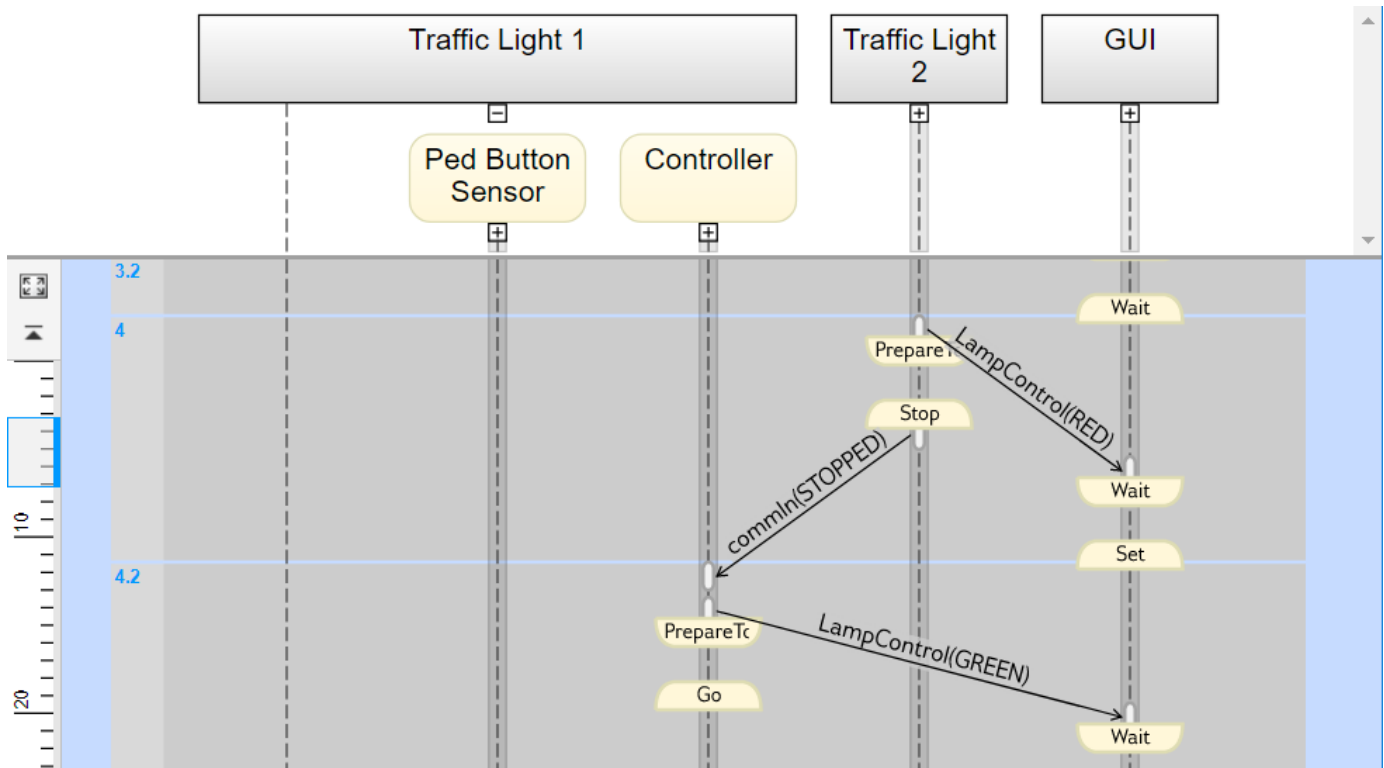

Expand a Masked Subsystem Lifeline

The Sequence Viewer window displays masked subsystems as white blocks. To show the children of a masked subsystem, point over the bottom left corner of the lifeline header and click the arrow.

For example, the GUI subsystem contains four masked subsystems: Traffic Lamp 1, Traffic Lamp 2, Ped Lamp 1, and Ped Lamp 2.

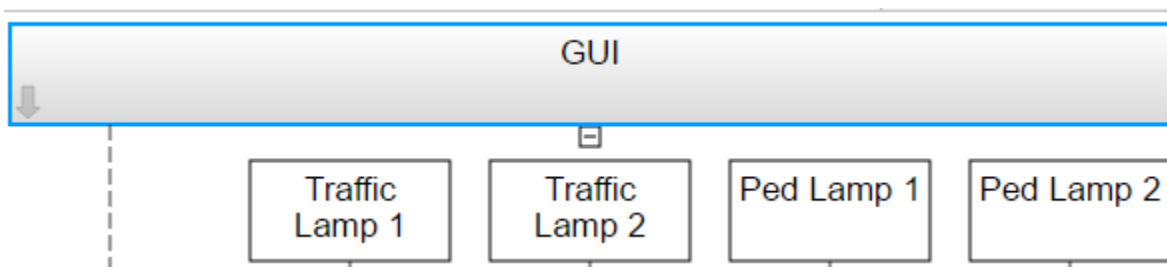

You can display the child lifelines in these masked subsystems by clicking the arrow in the parent lifeline header.

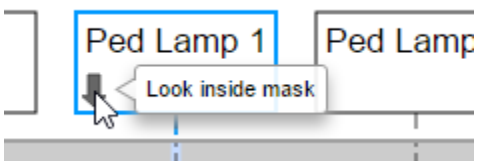

Change Root of Focus

To make a lifeline the root of focus for the viewer, point over the bottom left corner of the lifeline header and click the arrow. Alternatively, you can use the navigation toolbar at the top of the Sequence Viewer window to move the current root up and down the lifeline hierarchy. To move the current root up one level, press the **Esc** key.

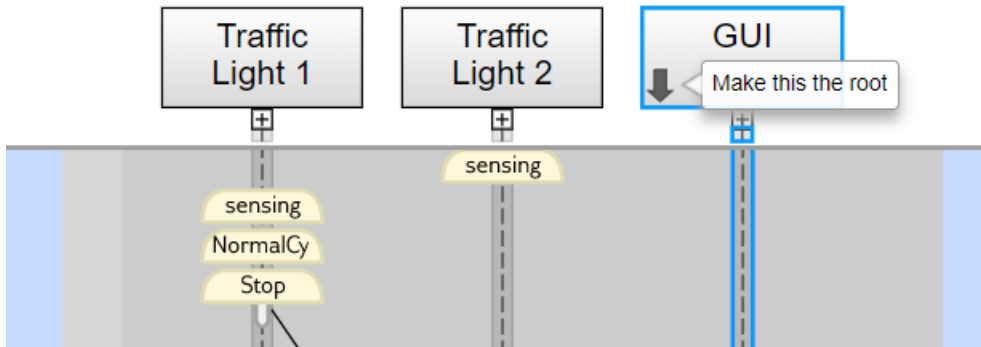

The Sequence Viewer window displays the current root lifeline path and shows its child lifelines. Any external events and messages are displayed as entering or exiting through vertical slots in the diagram gutter. When you point to a slot in the diagram gutter, a tooltip displays the name of the sending or receiving block.

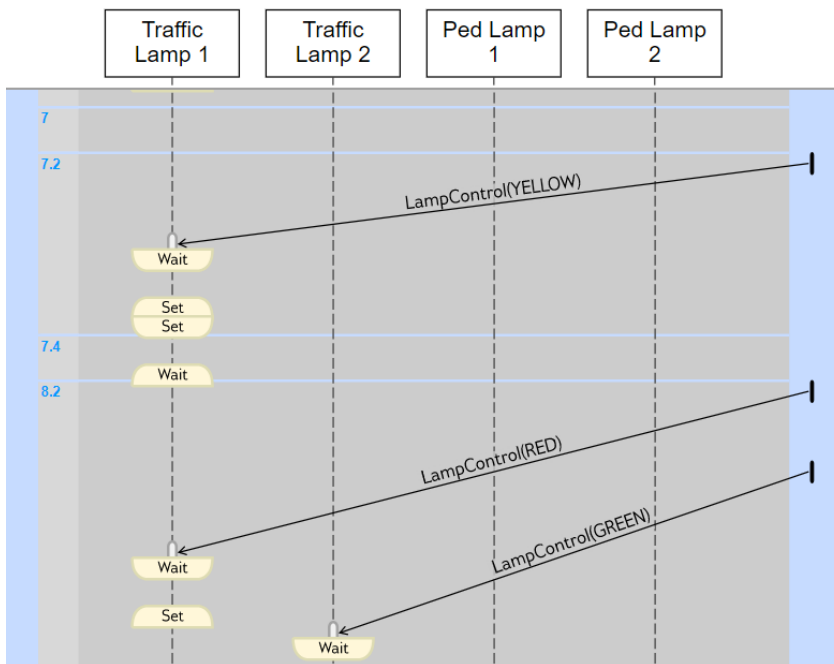

View State Activity and Transitions

To see state activity and transitions in the Sequence Viewer window, expand the state hierarchy until you have reached the lowest child state. Vertical yellow bars show which state is active. Blue horizontal arrows denote the transitions between states.

In this example, you can see a transition from Go to PrepareToStop followed, after 1 second, by a transition to Stop.

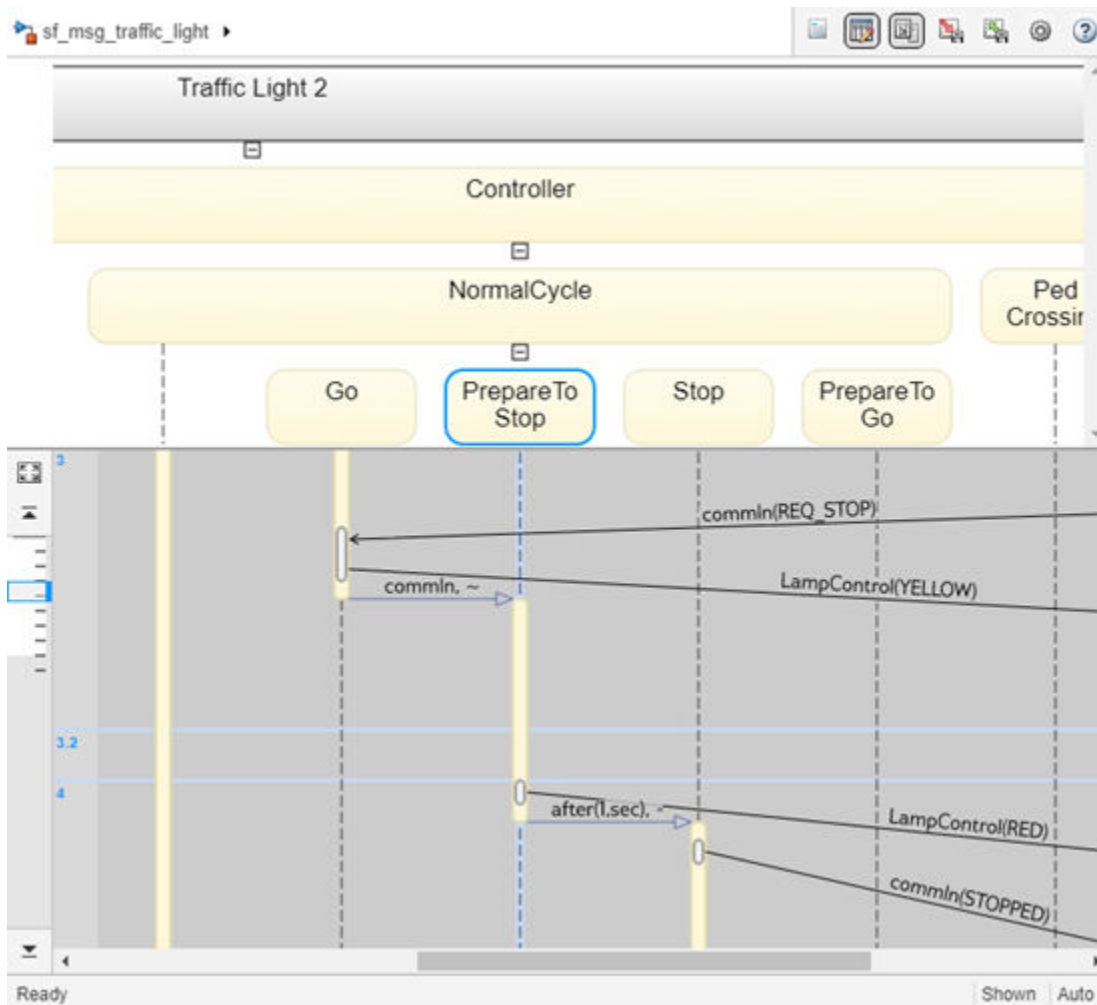

To display the start state, end state, and full transition label in the Property Inspector, click the arrow corresponding to the transition.

To display information about the interactions that occur while a state is active, click the yellow bar corresponding to the state. In the Property Inspector, use the **Search Up** and **Search Down** buttons to move through the transitions, messages, events, and function calls that take place while the state is active.

View Function Calls

The Sequence Viewer block displays function calls and replies. This table lists the type of support for each type of function call.

Function Call Type	Support
Calls to Simulink Function blocks	Fully supported

Function Call Type	Support
Calls to Stateflow graphical or Stateflow MATLAB functions	<ul style="list-style-type: none"> • Scoped — Select the Export chart level functions chart option. Use the <i>chartName.functionName</i> dot notation. • Global — Select the Treat exported functions as globally visible chart option. You do not need the dot notation.
Calls to function-call subsystems	Not displayed in the Sequence Viewer window

The Sequence Viewer window displays function calls as solid arrows labeled with the format *function_name(argument_list)*. Replies to function calls are displayed as dashed arrows labeled with the format *[argument_list]=function_name*.

For example, in the model `slexPrinterExample`, a subsystem calls the Simulink Function block `addPrinterJob`. The function block replies with an output value of `false`.

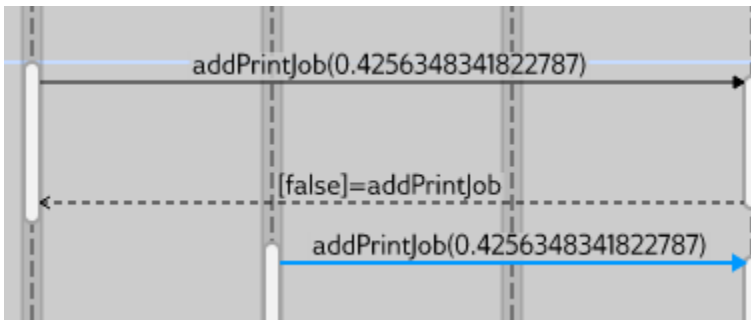

Simulation Time in the Sequence Viewer Window

The Sequence Viewer window shows events vertically, ordered in time. Multiple events in Simulink can happen at the same time. Conversely, there can be long periods of time during simulation with no events. As a consequence, the Sequence Viewer window shows time by using a combination of linear and nonlinear displays. The time ruler shows linear simulation time. The time grid shows time in a nonlinear fashion. Each time grid row, bordered by two blue lines, contains events that occur at the same simulation time. The time strip provides the times of the events in that grid row.

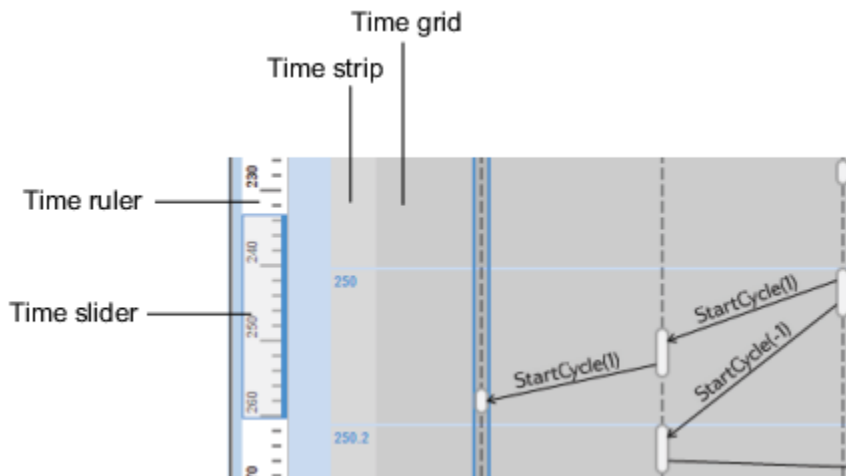



To show events in a specific simulation time range, use the scroll wheel or drag the time slider up and down the time ruler. To navigate to the beginning or end of the simulation, click the **Go to first event** or **Go to last event** buttons. To see the entire simulation duration on the time ruler, click the **Fit to view** button .

When using a variable step solver, you can adjust the precision of the time ruler. In the Model Explorer, on the **Main** tab of the Sequence Viewer Block Parameters pane, adjust the value of the **Time Precision for Variable Step** field.

Redisplay of Information in the Sequence Viewer Window

The Sequence Viewer block saves the order and states of lifelines between simulation runs. When you close and reopen the Sequence Viewer window, it preserves the last open lifeline state. To save a

particular viewer state, click the **Save Settings** button  in the toolbar. Saving the model then saves that state information across sessions. To load the saved settings, click the **Restore Settings** button .

You can modify the **Time Precision for Variable Step** and **History** parameters only between simulations. You can access the buttons in the toolbar before simulation or when the simulation is paused. During a simulation, the buttons in the toolbar are disabled.

See Also

Sequence Viewer

More About

- “Synchronize Model Components by Broadcasting Events” on page 11-2
- “Communicate with Stateflow Charts by Sending Messages” on page 12-2
- “Model a Distributed Traffic Control System by Using Messages” on page 12-29

View Differences Between Stateflow Messages, Events, and Data

This example compares the behavior of messages, events, and data in Stateflow®.

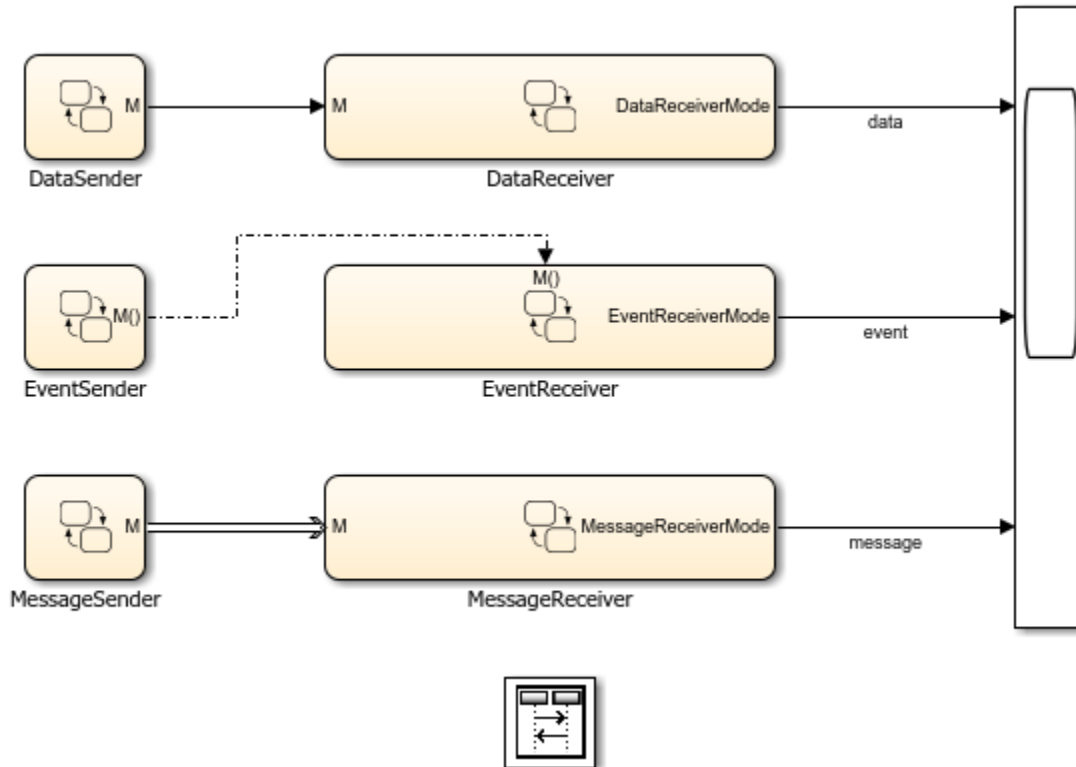

Sender Charts

This model has three sender charts: **DataSender**, **EventSender**, and **MessageSender**. Each sender chart has one state. In the entry action of the state, the charts assign a value to **data**, send a function-call event, or send a message.

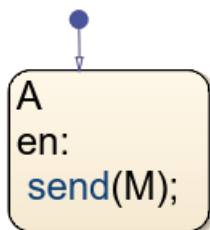

Receiver Charts

For each of the sender charts, there is a corresponding receiver chart. Each receiver chart has a state diagram with states **A0**, **A1**, **A2**, and **A3**. The implicit event `after(3, sec)` triggers the transition from **A0** to **A1**. The **data**, **event**, or **message** from the corresponding sender chart guards the transitions between **A1**, **A2**, and **A3**.

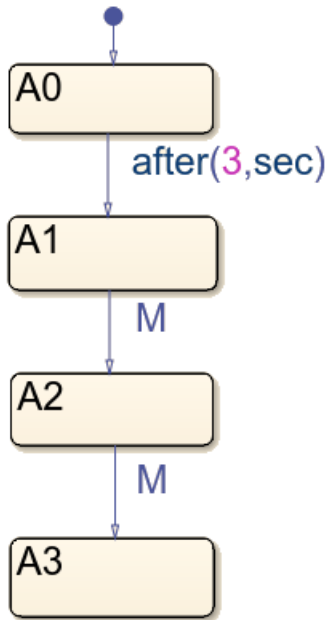

Scope Output

Each receiver chart has active state output enabled and connected to a scope. The scope shows which states are active in each time step. This output highlights the difference in behavior between output data, events, and messages.

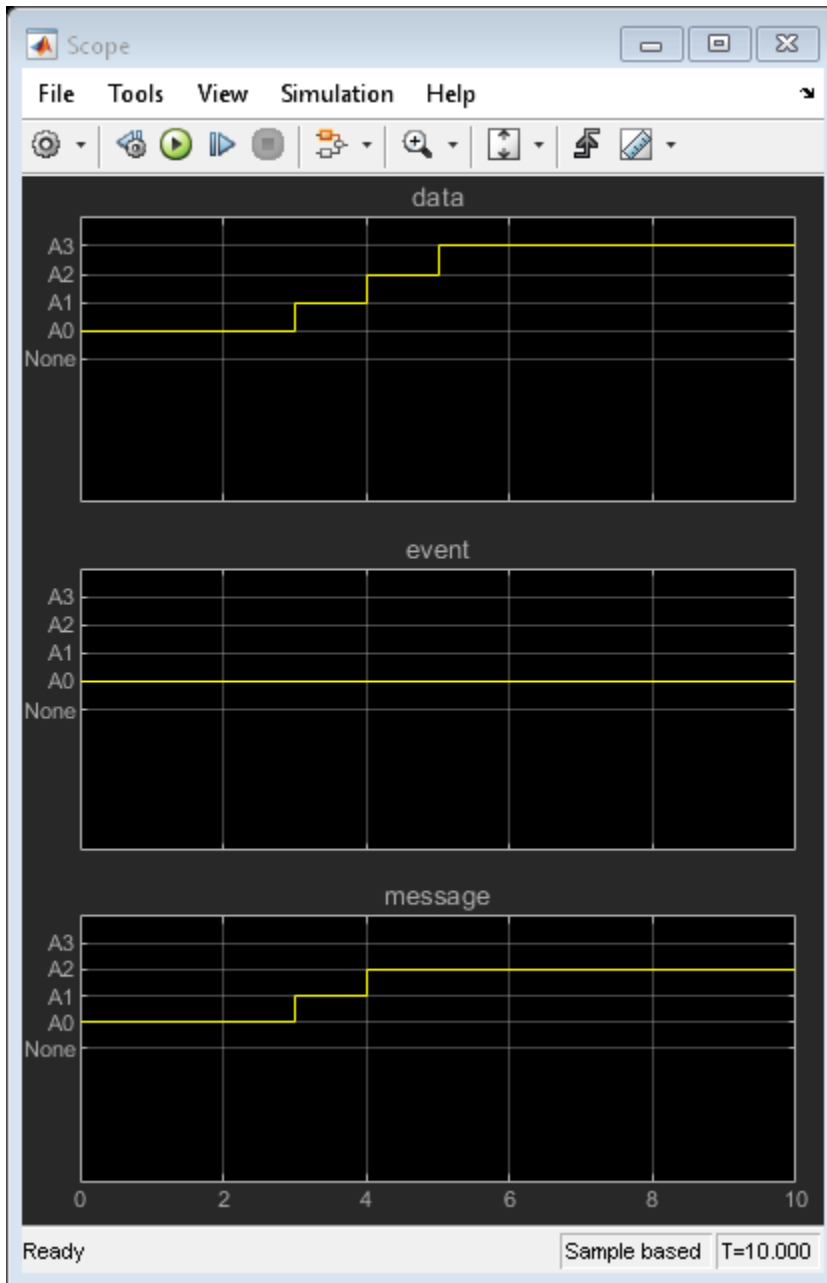

Behavior of Data

The DataSender chart assigns a value of 1 to the output data M, which connects as an input to the DataReceiver chart.

The DataReceiver chart executes once at every time step. At the start of simulation, state A0 is active. At time $t=3$, the transition from A0 to A1 occurs. At time $t=4$, the chart tests whether M equals 1. This condition is true, so the chart transitions from A1 to A2. At time $t=5$, M still equals 1, so the chart transitions from A2 to A3. On the scope, you see that DataReceiver changes states three times.

After data is assigned a value, it holds its value throughout the simulation. Therefore, each time that the DataReceiver evaluates the condition `[M == 1]`, it transitions to a new state.

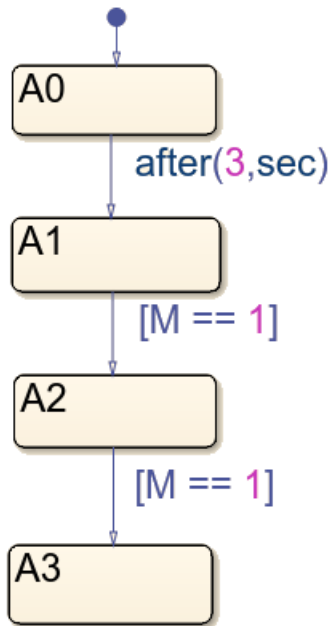

Behavior of Event

The EventSender chart uses the command `send(M)` to send a function-call output event to wake up the EventReceiver chart.

The EventReceiver chart executes only when the input event `M` wakes up the chart. At the start of simulation, state `A0` is active. The transition from `A0` to `A1` is based on absolute-time temporal logic and is not valid at time `t=0`. `A0` remains active and the chart goes back to sleep. Because EventSender sends the event `M` only once, EventReceiver does not wake up again. On the scope, you see that EventReceiver never transitions out of `A0`.

Events do not remain valid across time steps, so the receiving chart has only one chance to respond to the event. When EventSender sends the event, EventReceiver is not ready to respond to it. The opportunity for EventReceiver to transition in response to the event is lost.

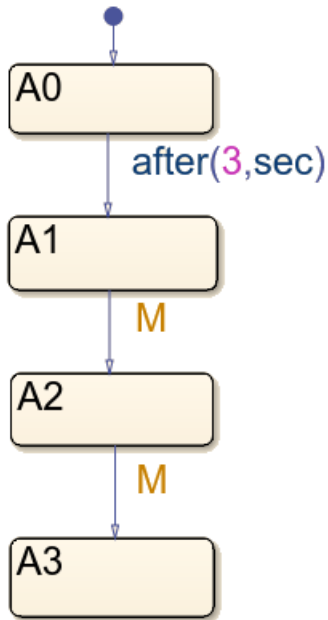

Behavior of Message

The `MessageSender` chart uses the syntax `send(M)` to send a message through the output message port. The message goes into the input message queue of the `MessageReceiver` chart. The message waits in the queue until `MessageReceiver` evaluates it.

The `MessageReceiver` chart executes once at every time step. At the start of simulation, state `A0` is active. At time $t=3$, the transition from `A0` to `A1` occurs. At time $t=4$, the chart determines that `M` is present in the queue, so it takes the transition to `A2`. At the end of the time step, the chart removes `M` from the queue. At time $t=5$, there is no message present in the queue, so the chart does not transition to `A3`. `A2` remains the active state. On the scope, you see that `MessageReceiver` changes state only two times.

Unlike events, messages are queued. The receiving chart can choose to respond to a message anytime after it was sent. Unlike data, the message does not remain valid indefinitely. The message is destroyed at the end of the time step.

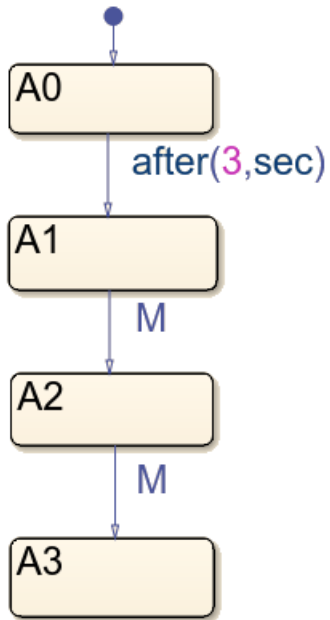

See Also

More About

- “Share Data with Simulink and the MATLAB Workspace” on page 9-19
- “Synchronize Model Components by Broadcasting Events” on page 11-2
- “Communicate with Stateflow Charts by Sending Messages” on page 12-2

Model a Distributed Traffic Control System by Using Messages

This example shows how to model a distributed control system for an intersection of one-way roads. To coordinate the state of the traffic lights, the two charts communicate with each other by using messages. The design of the two charts is identical.

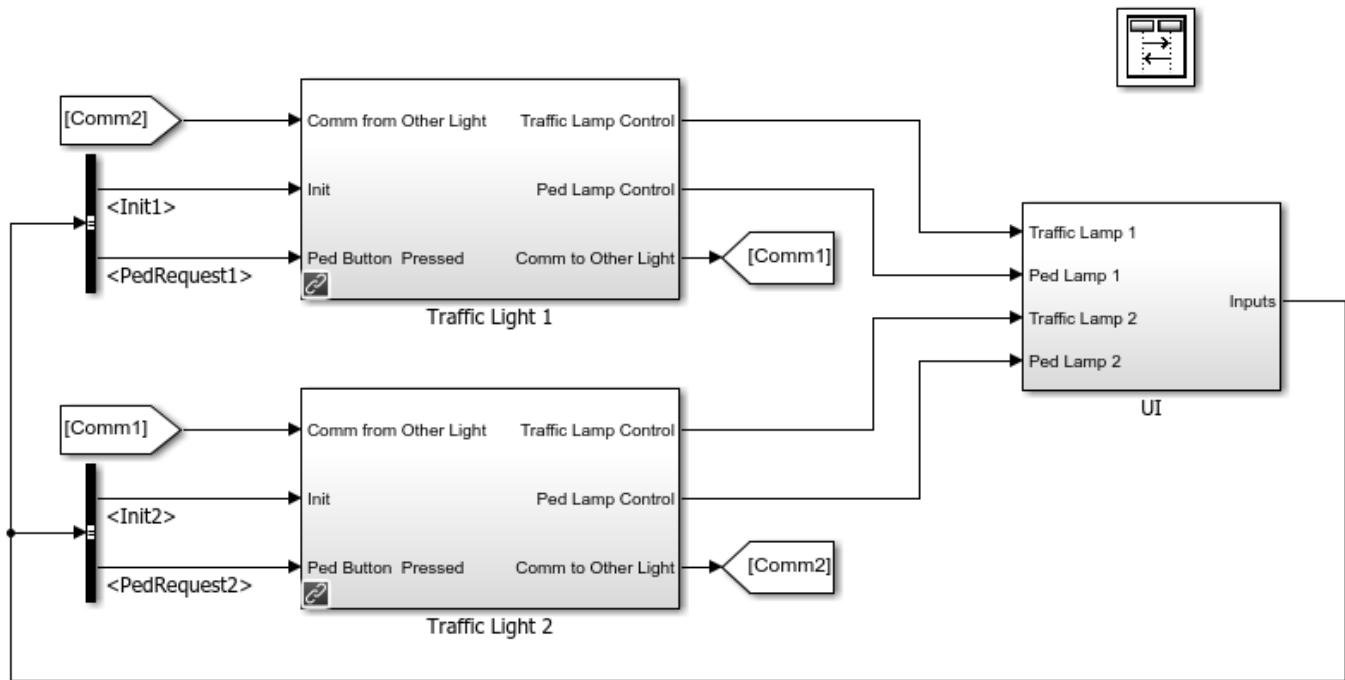

You can interact with the traffic signals through a MATLAB® UI. To request a pedestrian crossing, click one of the dark gray request buttons at the bottom of the traffic signal.

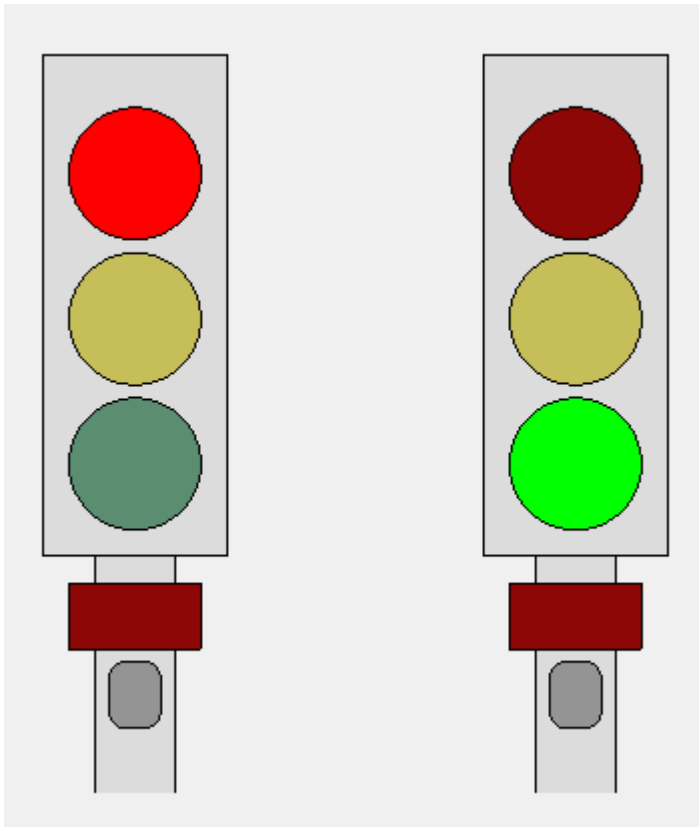

The controller for each road is implemented by the traffic light controller subsystems Traffic Light 1 and Traffic Light 2.

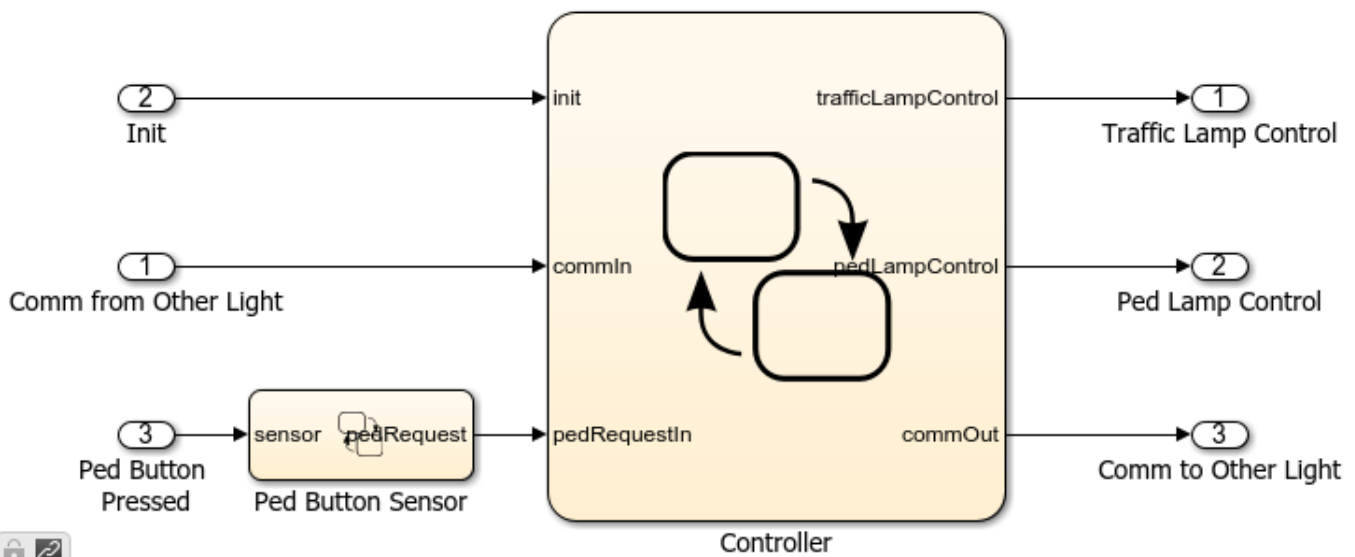

In each subsystem, the Controller chart describes the main logic of the traffic controller through the various states of the traffic signal.

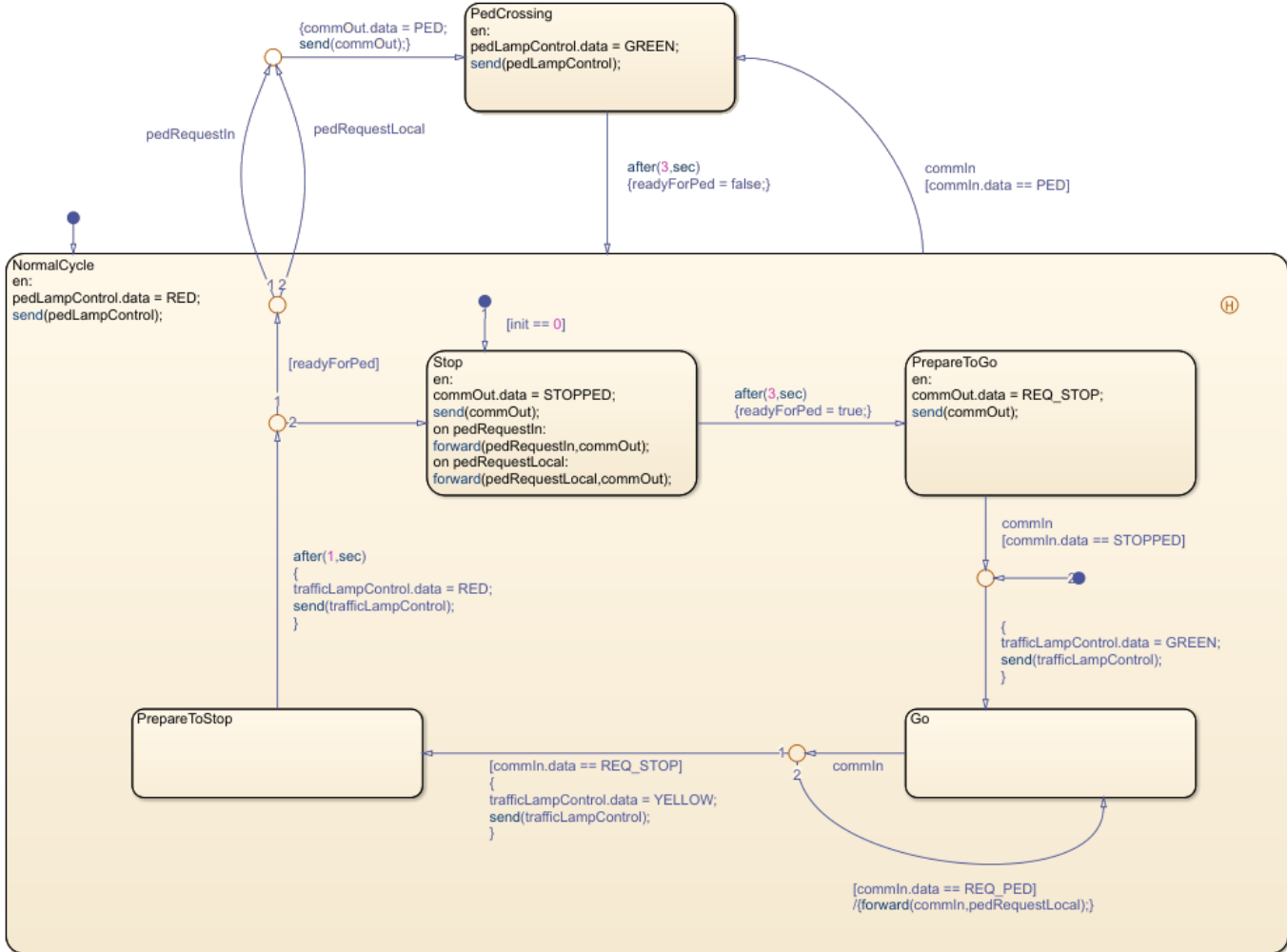

This model takes advantage of these semantic features of messages:

- Messages are not discarded if they are not acted upon immediately. For example, in this model, pedestrian requests are queued up until the controller can react to a request when the traffic light turns red.
- You can set up message loops between different components. These loops do not result in algebraic loops in your model.
- Normally, input messages are destroyed at the end of the time step in which they are evaluated. However, you can preserve these input messages for use at a later time by temporarily forwarding them to a local "holding" queue. For example, when the Controller chart exits the Go state, it uses the local queue `pedRequestLocal` to store pedestrian requests made on the other road. The chart checks for those requests later, when it exits the PrepareToStop state.

To change the speed of the simulation, in the **Simulation** tab, select **Run > Simulation Pacing**. In the Simulation Pacing Options dialog box, adjust the slider setting. For more information, see “Simulation Pacing” (Simulink).

See Also

More About

- “Communicate with Stateflow Charts by Sending Messages” on page 12-2
- “Use the Sequence Viewer Block to Visualize Messages, Events, and Entities” on page 12-14
- “View Differences Between Stateflow Messages, Events, and Data” on page 12-23
- “Simulation Pacing” (Simulink)

Use Actions in Charts

- “State Action Types” on page 13-2
- “Transition Action Types” on page 13-7
- “Eliminate Redundant Code by Combining State Actions” on page 13-10
- “Supported Operations for Chart Data” on page 13-13
- “Supported Symbols in Actions” on page 13-20
- “Call C Library Functions in C Charts” on page 13-23
- “Access MATLAB Functions and Workspace Data in C Charts” on page 13-28
- “Broadcast Local Events to Synchronize Parallel States” on page 13-37
- “Control Chart Execution by Using Temporal Logic” on page 13-40
- “Detect Changes in Data Values” on page 13-56
- “Control Function-Call Subsystems by Using bind Actions” on page 13-63
- “Control Oscillations by Using the duration Operator” on page 13-70

State Action Types

States can have different action types, including entry, during, exit, bind, and, on actions. You specify the actions for a state by using a state action label with this overall format:

```
name/
entry:entry actions
during:during actions
exit:exit actions
bind:data_name, event_name
on event_name:on event_name actions
on message_name:on message_name actions
```

Enter actions of different types on separate lines after the name of the state. You can enter these actions in any order. If you do *not* specify the action type explicitly for a statement, the chart treats that statement as a combined entry, during action.

For example, this chart contains various state action types.

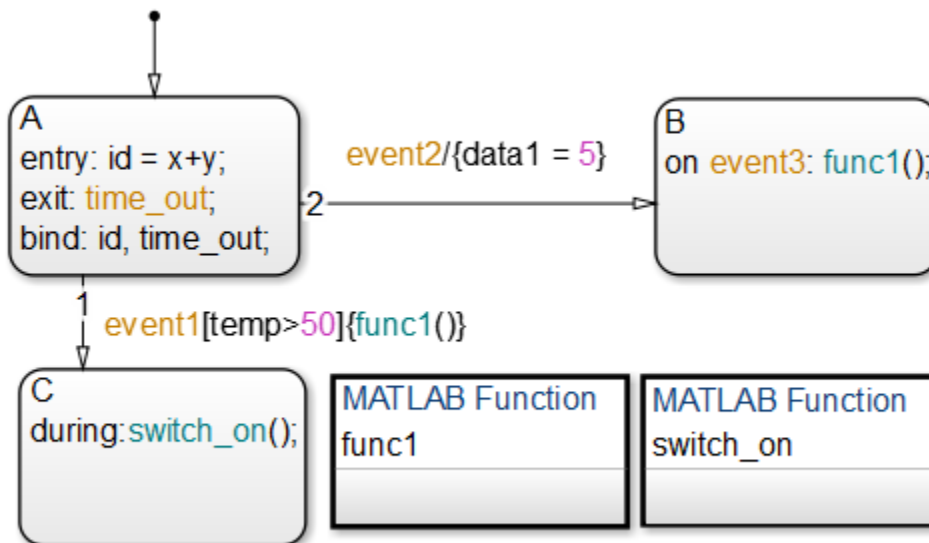

This table summarizes the different state action types.

State Action	Abbreviation	Description
entry	en	Executes when the state becomes active.
exit	ex	Executes when the state is active and a transition out of the state occurs.
during	du	Executes when the state is active and a specific event occurs.
bind	none	Binds an event or data object so that only that state and its children can broadcast the event or change the data value.

State Action	Abbreviation	Description
on <i>event_name</i>	none	Executes when the state is active and it receives a broadcast of <i>event_name</i> .
on <i>message_name</i>	none	Executes when a message <i>message_name</i> is available.
on after(<i>n,event_name</i>) on after(<i>n,sec</i>) on after(<i>n,msec</i>) on after(<i>n,usec</i>)	none	Executes when: <ul style="list-style-type: none"> the event <i>event_name</i> has occurred at least <i>n</i> times since the associated state became active. at least <i>n</i> units of time have elapsed since the associated state became active. For more information, see <code>after</code> .
on at(<i>n,event_name</i>) on at(<i>n,sec</i>)	none	Executes when: <ul style="list-style-type: none"> the event <i>event_name</i> has occurred exactly <i>n</i> times since the associated state became active. exactly <i>n</i> seconds have elapsed since the associated state became active. For more information, see <code>at</code> .
on before(<i>n,event_name</i>) on before(<i>n,sec</i>) on before(<i>n,msec</i>) on before(<i>n,usec</i>)	none	Executes when: <ul style="list-style-type: none"> the event <i>event_name</i> has occurred fewer than <i>n</i> times since the associated state became active. fewer than <i>n</i> units of time have elapsed since the associated state became active. For more information, see <code>before</code> .
on every(<i>n,event_name</i>) on every(<i>n,sec</i>)	none	Executes: <ul style="list-style-type: none"> every <i>n</i>th occurrence of the event <i>event_name</i> since the associated state became active. every <i>n</i> seconds since the associated state became active. For more information, see <code>every</code> .

entry Actions

Entry actions are executed when a state becomes active. Entry actions consist of the prefix `entry` (or the abbreviation `en`) followed by a colon (`:`) and one or more actions. To separate multiple entry actions, use semicolons or commas. You can also enter the actions on separate lines.

In the preceding example, the entry action `id = x+y` executes when the chart takes the default transition and state A becomes active. See “Enter a Chart or State” on page 3-28.

exit Actions

Exit actions are executed when a state is active and a transition out of the state occurs. Exit actions consist of the prefix `exit` (or the abbreviation `ex`) followed by a colon (`:`) and one or more actions. To separate multiple exit actions, use semicolons or commas. You can also enter the actions on separate lines.

In the preceding example, the exit action `time_out` executes when the chart takes one of the transitions from state A to state B or C. See “Exit a State” on page 3-34.

during Actions

During actions are executed when a state is active, an event occurs, and no valid transition to another state or the current state is available. During actions consist of the prefix `during` (or the abbreviation `du`) followed by a colon (`:`) and one or more actions. To separate multiple during actions, use semicolons or commas. You can also enter the actions on separate lines.

In the preceding example, the during action `switch_on()` executes whenever the state C is active because there are no valid transitions to another state. See “Execution of a Stateflow Chart” on page 3-23.

bind Actions

You can bind the data and events to a state by using a `bind` action. A `bind` action consists of the prefix `bind` followed by a colon (`:`) and one or more events or data. To separate multiple events and data, use semicolons or commas. You can also enter the events and data on separate lines.

Only a state and its children can change data or broadcast events bound to that state. Other states can read the bound data or listen for the bound event, but they cannot change the bound data or send the bound events.

Bind actions apply to a chart whether the binding state is active or not. In the preceding example, the bind action `bind: id, time_out` for state A binds the data `id` and the event `time_out` to state A. This binding prevents any other state (or its children) in the chart from changing `id` or broadcasting event `time_out`.

If another state includes actions that change data or broadcast events that bind to another state, a parsing error occurs. This chart contains two state actions that produce parsing errors.

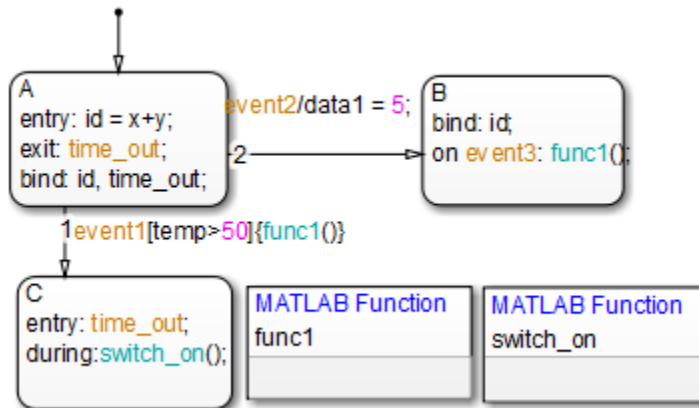

State Action	Reason for Parse Error
bind: id in state B	Only one state can change the data id, which is bound to state A
entry: time_out in state C	Only one state can broadcast the event time_out, which is bound to state A

Binding a function-call event to a state also binds the function-call subsystem that it calls. The function-call subsystem is enabled when the binding state is entered and disabled when the binding state is exited. For more information about this behavior, see “Control Function-Call Subsystems by Using bind Actions” on page 13-63.

Bind actions are supported only in Stateflow charts in Simulink models.

on Actions

On actions are executed when the state is active and it receives an event or message. On actions consist of the prefix `on` followed by a unique event `event_name` or message `message_name`, a colon (:), and one or more actions. To separate multiple on actions, use semicolons or commas. You can also enter the actions on separate lines.

You can specify actions for more than one event or message. For example, if you want different events to trigger different actions, enter multiple on action statements in the state action label:

```
on ev1: action1();
on ev2: action2();
```

If multiple events occur at the same time, the corresponding on actions execute in the order that they appear in the state action label. For instance, in the previous example, if events `ev1` and `ev2` occur at the same time, then `action1()` executes first and `action2()` executes second. See “Execution of a Stateflow Chart” on page 3-23.

See Also

Related Examples

- “Execution of a Stateflow Chart” on page 3-23

- “Enter a Chart or State” on page 3-28
- “Exit a State” on page 3-34
- “Eliminate Redundant Code by Combining State Actions” on page 13-10
- “Control Function-Call Subsystems by Using bind Actions” on page 13-63
- “Control Chart Execution by Using Temporal Logic” on page 13-40

Transition Action Types

Transitions can have different action types, which include event or message triggers, conditions, condition actions, and transition actions. The action types follow the label notation with this general format:

```
event_or_message trigger[condition]{condition_action}/{transition_action}
```

The following example shows typical transition label syntax:

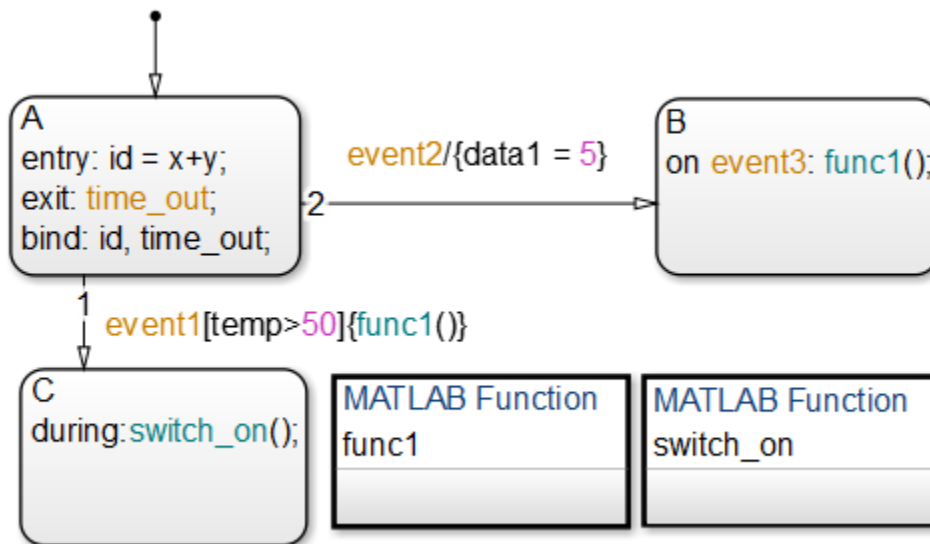

Transition	Event Trigger	Condition	Condition Action	Transition Action
State A to state C	event1	temp > 50	func1()	None
State A to state B	event2	None	None	data1 = 5

Event or Message Triggers

In transition label syntax, event or message triggers appear first as the name of an event or message. They have no distinguishing special character to separate them from other actions in a transition label. In the example in “Transition Action Types” on page 13-7, both transitions from state A have event triggers. The transition from state A to state B has the event trigger event2 and the transition from state A to state C has the event trigger event1.

Event triggers specify an event that causes the transition to be taken, provided the condition, if specified, is true. Specifying an event is optional. Message triggers specify the transition to be taken if the message is present in the message queue. The absence of an event or message indicates that the transition is taken upon the occurrence of any event. Multiple events or messages are specified using the OR logical operator (|).

Conditions

In transition label syntax, conditions are Boolean expressions enclosed in square brackets ([]). In the example in “Transition Action Types” on page 13-7, the transition from state A to state C has the condition `temp > 50`.

A condition is a Boolean expression to specify that a transition occurs given that the specified expression is true. Follow these guidelines for defining and using conditions:

- The condition expression must be a Boolean expression that evaluates to true (1) or false (0).
- The condition expression can consist of any of the following:
 - Boolean operators that make comparisons between data and numeric values
 - A function that returns a Boolean value
 - An `in(state_name)` condition that evaluates to true when the state specified as the argument is active (see “Check State Activity by Using the in Operator” on page 10-14)

Note A chart cannot use the `in` condition to trigger actions based on the activity of states in other charts.

- Temporal logic conditions (see “Control Chart Execution by Using Temporal Logic” on page 13-40)
- The condition expression can call a graphical function, truth table function, or MATLAB function that returns a numeric value.

For example, `[test_function(x, y) < 0]` is a valid condition expression.

Note If the condition expression calls a function with multiple return values, only the first value applies. The other return values are not used.

- The condition expression should not call a function that causes the chart to change state or modify any variables.
- Boolean expressions can be grouped using `&` for expressions with AND relationships and `|` for expressions with OR relationships.
- Assignment statements are not valid condition expressions.
- Unary increment and decrement actions are not valid condition expressions.

Condition Actions

In transition label syntax, condition actions follow the transition condition and are enclosed in curly braces ({}). In the example in “Transition Action Types” on page 13-7, the transition from state A to state C has the condition action `func1()`, a function call.

Condition actions are executed as soon as the condition is evaluated as true, but before the transition destination has been determined to be valid. If no condition is specified, an implied condition evaluates to true and the condition action is executed.

Note If a condition is guarded by an event, it is checked only if the event trigger is active. If a condition is guarded by a message, it is checked only if the message is present.

Transition Actions

In transition label syntax, transition actions are preceded with a forward slash (/) and are enclosed in curly braces ({}). In the example in “Transition Action Types” on page 13-7, the transition from state A to state B has the transition action `data1 = 5`. In C charts, transition actions are not required to be enclosed in curly braces. In charts that use MATLAB as the action language, the syntax is auto corrected if the curly braces are missing from the transition action. See “Auto Correction When Using MATLAB as the Action Language” on page 14-2.

Transition actions execute only after the complete transition path is taken. They execute after the transition destination has been determined to be valid, and the condition, if specified, is true. If the transition consists of multiple segments, the transition action executes only after the entire transition path to the final destination is determined to be valid.

Transition actions are supported only in Stateflow charts in Simulink models.

Eliminate Redundant Code by Combining State Actions

You can combine entry, during, and exit actions that execute the same tasks in a state.

By combining state actions that execute the same tasks, you eliminate redundant code. For example:

Separate Actions	Equivalent Combined Actions
<pre>entry: y = 0; y=y+1; during: y=y+1;</pre>	<pre>entry: y = 0; entry, during: y=y+1;</pre>
<pre>en: fcn1(); fcn2(); du: fcn1(); ex: fcn1();</pre>	<pre>en, du, ex: fcn1(); en: fcn2();</pre>

Combining state actions this way produces the same chart execution behavior (semantics) and generates the same code as the equivalent separate actions.

How to Combine State Actions

Combine a set of entry, during, and/or exit actions that perform the same task as a comma-separated list in a state. Here is the syntax:

```
entry, during, exit: task1; task2;...taskN;
```

You can also use the equivalent abbreviations:

```
en, du, ex: task1; task2;...taskN;
```

Valid Combinations

You can use any combination of the three actions. For example, the following combinations are valid:

- en, du:
- en, ex:
- du, ex:
- en, du, ex:

You can combine actions in any order in the comma-separated list. For example, en, du: gives the same result as du, en:.

Invalid Combinations

You cannot combine two or more actions of the same type. For example, the following combinations are invalid:

- en, en:
- ex, en, ex:
- du, du, ex:

If you combine multiple actions of the same type, you receive a warning that the chart executes the action only once.

Order of Execution of Combined Actions

States execute combined actions in the same order as they execute separate actions:

- 1 Entry actions first, from top to bottom in the order they appear in the state
- 2 During actions second, from top to bottom
- 3 Exit actions last, from top to bottom

The order in which you combine actions does not affect state execution behavior. For example:

This state...	Executes actions in this order...
<div style="border: 1px solid black; border-radius: 10px; padding: 10px; background-color: #f0f0f0;"> <p>A</p> <pre>en: y = 0; en, du: y = y + 1;</pre> </div>	<ol style="list-style-type: none"> 1 en: y = 0; 2 en: y=y+1; 3 du: y=y+1;
<div style="border: 1px solid black; border-radius: 10px; padding: 10px; background-color: #f0f0f0;"> <p>B</p> <pre>en, du: y = y + 1; en: y = 0;</pre> </div>	<ol style="list-style-type: none"> 1 en: y=y+1; 2 en: y = 0; 3 du: y=y+1;
<div style="border: 1px solid black; border-radius: 10px; padding: 10px; background-color: #f0f0f0;"> <p>C</p> <pre>du, en: y = y + 1; en: y = 0;</pre> </div>	<ol style="list-style-type: none"> 1 en: y=y+1; 2 en: y = 0; 3 du: y=y+1;
<div style="border: 1px solid black; border-radius: 10px; padding: 10px; background-color: #f0f0f0;"> <p>D</p> <pre>du, en: y = y + 1; en, ex: y = 10;</pre> </div>	<ol style="list-style-type: none"> 1 en: y=y+1; 2 en: y = 10; 3 du: y=y+1; 4 ex: y = 10;

Rules for Combining State Actions

- Do not combine multiple actions of the same type.
- Do not create data, events, or messages that have the same name as the action keywords: `entry`, `en`, `during`, `du`, `exit`, `ex`.



See Also

More About

- “State Action Types” on page 13-2

Supported Operations for Chart Data

Stateflow charts in Simulink models have an action language property that defines the operations that you can use in state and transition actions. The language properties are:

-  MATLAB as the action language.
-  C as the action language.

For more information, see “Differences Between MATLAB and C as Action Language Syntax” on page 14-5.

Binary Operations

This table summarizes the interpretation of all binary operations in Stateflow charts according to their order of precedence (0 = highest, 10 = lowest). Binary operations are left associative so that, in any expression, operators with the same precedence are evaluated from left to right. The order of evaluation for other operations is unspecified. For example, in this assignment

$$A = f() > g();$$

the order of evaluation of $f()$ and $g()$ is unspecified. For more predictable results, it is good coding practice to split expressions that depend on the order of evaluation into multiple statements.

Operation	Precedence	MATLAB as the Action Language	C as the Action Language
$a \wedge b$	0	Power.	Power. This operation is equivalent to the C library function <code>pow</code> . Operands are first cast to floating-point numbers. For more information, see “Call C Library Functions” on page 13-23. Enable this operation by clearing the Enable C-bit operations chart property. For more information, see “Enable C-Bit Operations” on page 25-4.
$a * b$	1	Multiplication.	Multiplication.
a / b	1	Division.	Division.
$a \% b$	1	Not supported. Use the <code>rem</code> or <code>mod</code> function.	Remainder. Noninteger operands are first cast to integers.
$a + b$	2	Addition.	Addition.
$a - b$	2	Subtraction.	Subtraction.
$a \gg b$	3	Not supported. Use the <code>bitshift</code> function.	Shift <code>a</code> to the right by <code>b</code> bits. For more information, see “Bitwise Operations” on page 13-17.

Operation	Precedence	MATLAB as the Action Language	C as the Action Language
$a \ll b$	3	Not supported. Use the <code>bitshift</code> function.	Shift a to the left by b bits. For more information, see “Bitwise Operations” on page 13-17.
$a > b$	4	Comparison, greater than.	Comparison, greater than.
$a < b$	4	Comparison, less than.	Comparison, less than.
$a \geq b$	4	Comparison, greater than or equal to.	Comparison, greater than or equal to.
$a \leq b$	4	Comparison, less than or equal to.	Comparison, less than or equal to.
$a == b$	5	Comparison, equal to.	Comparison, equal to.
$a ~= b$	5	Comparison, not equal to.	Comparison, not equal to.
$a != b$	5	Not supported. Use the operation <code>a ~= b</code> .	Comparison, not equal to.
$a <> b$	5	Not supported. Use the operation <code>a ~= b</code> .	Comparison, not equal to.
$a \& b$	6	Logical AND. For bitwise AND, use the <code>bitand</code> function.	<ul style="list-style-type: none"> Bitwise AND (default). Enable this operation by selecting the Enable C-bit operations chart property. Logical AND. Enable this operation by clearing the Enable C-bit operations chart property. <p>For more information, see “Bitwise Operations” on page 13-17 and “Enable C-Bit Operations” on page 25-4.</p>
$a \wedge b$	7	Not supported. For bitwise XOR, use the <code>bitxor</code> function.	Bitwise XOR (default). Enable this operation by selecting the Enable C-bit operations chart property. For more information, see “Bitwise Operations” on page 13-17 and “Enable C-Bit Operations” on page 25-4.
$a b$	8	Logical OR. For bitwise OR, use the <code>bitor</code> function.	<ul style="list-style-type: none"> Bitwise OR (default). Enable this operation by selecting the Enable C-bit operations chart property. Logical OR. Enable this operation by clearing the Enable C-bit operations chart property. <p>For more information, see “Bitwise Operations” on page 13-17 and “Enable C-Bit Operations” on page 25-4.</p>
$a \&\& b$	9	Logical AND.	Logical AND.
$a b$	10	Logical OR.	Logical OR.

Unary Operations and Actions

This table summarizes the interpretation of all unary operations and actions in Stateflow charts. Unary operations:

- Have higher precedence than the binary operators.
- Are right associative so that, in any expression, they are evaluated from right to left.

Operation	MATLAB as the Action Language	C as the Action Language
$\sim a$	Logical NOT. For bitwise NOT, use the <code>bitcmp</code> function.	<ul style="list-style-type: none"> • Bitwise NOT (default). Enable this operation by selecting the Enable C-bit operations chart property. • Logical NOT. Enable this operation by clearing the Enable C-bit operations chart property. <p>For more information, see “Bitwise Operations” on page 13-17 and “Enable C-Bit Operations” on page 25-4.</p>
$!a$	Not supported. Use the operation $\sim a$.	Logical NOT.
$-a$	Negative.	Negative.
$a++$	Not supported. Use the expression $a = a + 1$.	Increment. Equivalent to $a = a + 1$.
$a--$	Not supported. Use the expression $a = a - 1$.	Decrement. Equivalent to $a = a - 1$.

Assignment Operations

This table summarizes the interpretation of assignment operations in Stateflow charts.

Operation	MATLAB as the Action Language	C as the Action Language
$a = b$	Simple assignment.	Simple assignment.
$a := b$	Not supported. Use type cast operations to override fixed-point promotion rules. See “Type Cast Operations” on page 13-16.	Assignment of fixed-point numbers. See “Override Fixed-Point Promotion in C Charts” on page 23-15.
$a += b$	Not supported. Use the expression $a = a + b$.	Equivalent to $a = a + b$.
$a -= b$	Not supported. Use the expression $a = a - b$.	Equivalent to $a = a - b$.
$a *= b$	Not supported. Use the expression $a = a * b$.	Equivalent to $a = a * b$.
$a /= b$	Not supported. Use the expression $a = a / b$.	Equivalent to $a = a / b$.

Operation	MATLAB as the Action Language	C as the Action Language
$a \&= b$	Not supported. Use the expression <code>a = bitand(a,b)</code> .	Equivalent to <code>a = a&b</code> (bitwise AND). Enable this operation by selecting the Enable C-bit operations chart property. For more information, see “Bitwise Operations” on page 13-17 and “Enable C-Bit Operations” on page 25-4.
$a \hat{=} b$	Not supported. Use the expression <code>a = bitxor(a,b)</code> .	Equivalent to <code>a = a^b</code> (bitwise XOR). Enable this operation by selecting the Enable C-bit operations chart property. For more information, see “Bitwise Operations” on page 13-17 and “Enable C-Bit Operations” on page 25-4.
$a = b$	Not supported. Use the expression <code>a = bitor(a,b)</code> .	Equivalent to <code>a = a b</code> (bitwise OR). Enable this operation by selecting the Enable C-bit operations chart property. For more information, see “Bitwise Operations” on page 13-17 and “Enable C-Bit Operations” on page 25-4.

Type Cast Operations

To convert a value of one type to a value of another type, use type cast operations. You can cast data to an explicit type or to the type of another variable.

Cast to Explicit Data Type

To cast a numeric expression to an explicit data type, use a MATLAB type conversion function of the form:

```
<type_fun>(expression)
```

<type_fun> is a type conversion function that can be `double`, `single`, `int32`, `int16`, `int8`, `uint32`, `uint16`, `uint8`, or `fi`. <type_fun> can also be `boolean`, `int64`, or `uint64`. For example, this statement casts the expression `x+3` to a 16-bit unsigned integer and assigns its value to the data `y`:

```
y = uint16(x+3)
```

Alternatively, in charts that use MATLAB as the action language, you can use the `cast` function with a type keyword <type_key>:

```
cast(expression,<type_key>)
```

Type keywords include `'double'`, `'single'`, `'int32'`, `'int16'`, `'int8'`, `'uint32'`, `'uint16'`, and `'uint8'`. For instance, as in the preceding example, this statement casts the expression `x+3` to a 16-bit unsigned integer and assigns it to `y`:

```
y = cast(x+3,'uint16')
```

Cast Type Based on Other Data

To make type casting easier, you can convert the type of a numeric expression based on the types of other data.

In charts that use MATLAB as the action language, call the `cast` function with the keyword `'like'`. For example, this statement converts the value of `x+3` to the same type as that of data `z` and assigns it to `y`:

```
y = cast(x+3, 'like', z)
```

In this case, the data `z` can have any acceptable Stateflow type.

In charts that use C as the action language, the `type` operator returns the type of an existing Stateflow data. Use this return value in place of an explicit type in a `cast` operation. For example, this statement converts the value of `x+3` to the same type as that of data `z` and assigns it to `y`:

```
cast(x+3, type(z))
```

Bitwise Operations

This table summarizes the interpretation of all bitwise operations in Stateflow charts that use C as the action language.

Operation	Description
<code>a & b</code>	Bitwise AND.
<code>a b</code>	Bitwise OR.
<code>a ^ b</code>	Bitwise XOR.
<code>~a</code>	Bitwise NOT.
<code>a >> b</code>	Shift <code>a</code> to the right by <code>b</code> bits.
<code>a << b</code>	Shift <code>a</code> to the left by <code>b</code> bits.

Except for the bit shift operations `a >> b` and `a << b`, you must enable all bitwise operations by selecting the **Enable C-bit operations** chart property. See “Enable C-Bit Operations” on page 25-4.

Bitwise operations work on integers at the binary level. Noninteger operands are first cast to integers. Integer operands follow C promotion rules to determine the intermediate value of the result. This intermediate value is then cast to the type that you specify for the result of the operation.

Note Bitwise operations are not supported in charts that use MATLAB as the action language. Instead, use the functions `bitand`, `bitor`, `bitxor`, `bitnot`, or `bitshift`.

Bitwise Operations and Integer Overflows

The implicit cast used to assign the intermediate value of a bitwise operation can result in an overflow. To preserve the rightmost bits of the result and avoid unexpected behavior, disable the chart property **Saturate on Integer Overflows**.

For example, both charts in this model compute the bitwise operation `y = ~u`. The charts compute the intermediate value for this operation by using the target integer size of 32 bits, so the 24 leftmost

bits in this value are all ones. When the charts assign the intermediate value to `y`, the cast to `uint8` causes an integer overflow. The output from each chart depends on how the chart handles integer overflows.

- If **Saturate on Integer Overflow** is enabled, the chart saturates the result of the bitwise operation and outputs a value of zero.
- If **Saturate on Integer Overflow** is disabled, the chart wraps the result of the bitwise operation and outputs its eight rightmost bits.

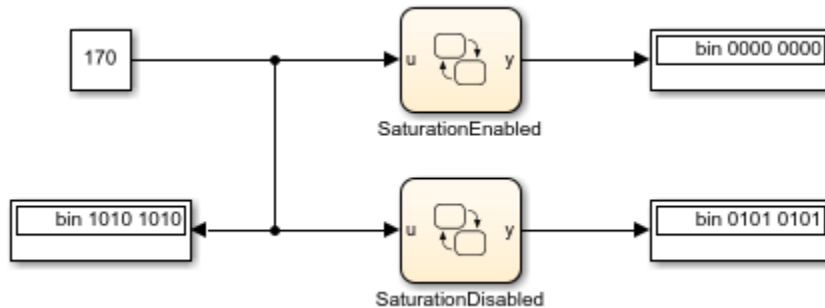

For more information, see “Saturate on Integer Overflow” on page 25-5.

Pointer and Address Operations

This table summarizes the interpretation of pointer and address operations in Stateflow charts that use C as the action language.

Operation	Description
<code>&a</code>	Address operation. Use with custom code and Stateflow variables.
<code>*a</code>	Pointer operation. Use only with custom code variables.

For example, the model `sf_bus_demo` contains a custom C function that takes pointers as arguments. When the chart calls the custom code function, it uses the `&` operation to pass the Stateflow data by address. For more information, see “Integrate Custom Structures in Stateflow Charts” on page 26-10.

Pointer and address operations are not supported in charts that use MATLAB as the action language.

Replace Operations with Application Implementations

If you have Embedded Coder or Simulink Coder, you can configure the code generator to apply a code replacement library (CRL) during code generation. The code generator changes the code that it generates for operations to meet application requirements. With Embedded Coder, you can develop and apply custom code replacement libraries.

Operation entries of the code replacement library can specify integral or fixed-point operand and result patterns. You can use operation entries for these operations:

- Addition +

- Subtraction -
- Multiplication *
- Division /

For example, in this expression, you can replace the addition operator + with a target-specific implementation if `u1`, `u2`, and `y` have types that permit a match with an addition entry in the code replacement library:

```
y = u1+u2
```

C chart semantics limit operator entry matching because the chart uses the target integer size as its intermediate type in arithmetic expressions. For example, this arithmetic expression computes the intermediate addition into a target integer:

```
y = (u1 + u2) % 3
```

If the target integer size is 32 bits, then you cannot replace this expression with an addition operator from the code replacement library and produce a signed 16-bit result without a loss of precision.

For more information about using code replacement libraries that MathWorks® provides, see “What Is Code Replacement?” (Simulink Coder) and “Code Replacement Libraries” (Simulink Coder). For information about developing custom code replacement libraries, see “What Is Code Replacement Customization?” (Embedded Coder) and “Code You Can Replace From Simulink Models” (Embedded Coder).

See Also

More About

- “Differences Between MATLAB and C as Action Language Syntax” on page 14-5
- “Specify Properties for Stateflow Charts” on page 25-2
- “Supported Operations for Fixed-Point Data” on page 23-12

Supported Symbols in Actions

Boolean Symbols, true and false

Use the symbols `true` and `false` to represent Boolean constants. You can use these symbols as scalars in expressions. Examples include:

```
cooling_fan = true;
heating_fan = false;
```

Tip These symbols are case-sensitive. Therefore, `TRUE` and `FALSE` are not Boolean symbols.

Do not use `true` and `false` in the following cases. Otherwise, error messages appear.

- Left-hand side of assignment statements
 - `true++;`
 - `false += 3;`
 - `[true, false] = my_function(x);`
- Argument of the change implicit event (see “Control Chart Behavior by Using Implicit Events” on page 11-23)
 - `change(true);`
 - `chg(false);`
- Indexing into a vector or matrix (see “Supported Operations for Vectors and Matrices” on page 18-4)
 - `x = true[1];`
 - `y = false[1][1];`

Note If you define `true` and `false` as Stateflow data objects, your custom definitions of `true` and `false` override the built-in Boolean constants.

Comment Symbols, %, //, /*

Use the symbols `%`, `//`, and `/*` to represent comments as shown in these examples:

```
% MATLAB comment line
// C++ comment line
/* C comment line */
```

You can also include comments in generated code for an embedded target (see “Model Configuration Parameters: Comments” (Simulink Coder). C chart comments in generated code use multibyte character code. Therefore, you can have code comments with characters for non-English alphabets, such as Japanese Kanji characters.

Hexadecimal Notation Symbols, 0xFF

C charts support C style hexadecimal notation, for example, 0xFF. You can use hexadecimal values wherever you can use decimal values.

Infinity Symbol, inf

Use the MATLAB symbol `inf` to represent infinity in C charts. Calculations like $n/0$, where n is any nonzero real value, result in `inf`.

Note If you define `inf` as a Stateflow data object, your custom definition of `inf` overrides the built-in value.

Line Continuation Symbol, ...

Use the characters `...` at the end of a line to indicate that the expression continues on the next line. For example, you can use the line continuation symbol in a state action:

```
entry: total1 = 0, total2 = 0, ...
      total3 = 0;
```

Literal Code Symbol, \$

Use `$` characters to mark actions that you want the parser to ignore but you want to appear in the generated code. For example, the parser does not process any text between the `$` characters below.

```
$
ptr -> field = 1.0;
$
```

Note Avoid frequent use of literal symbols.

MATLAB Display Symbol, ;

Omitting the semicolon after an expression displays the results of the expression in the Diagnostic Viewer. If you use a semicolon, the results do not appear.

Single-Precision Floating-Point Number Symbol, F

Use a trailing `F` to specify single-precision floating-point numbers in C charts. For example, you can use the action statement `x = 4.56F`; to specify a single-precision constant with the value 4.56. If a trailing `F` does not appear with a number, double precision applies.

Time Symbol, t



Use the letter `t` to represent absolute time that the chart inherits from a Simulink signal in simulation targets. For example, the condition `[t - On_time > Duration]` specifies that the condition is true if the difference between the simulation time `t` and `On_time` is greater than the value of `Duration`.

The letter **t** has no meaning for nonsimulation targets, since **t** depends on the specific application and target hardware.

Note If you define **t** as a Stateflow data object, your custom definition of **t** overrides the built-in value.

Call C Library Functions in C Charts

Stateflow charts in Simulink models have an action language property that defines the syntax for state and transition actions. An icon in the lower-left corner of the chart canvas indicates the action language for the chart.

-  MATLAB as the action language.
-  C as the action language.

Call C Library Functions

You can call this subset of the C Math Library functions:

<code>abs**</code>	<code>acos**</code>	<code>asin**</code>	<code>atan**</code>	<code>atan2**</code>	<code>ceil**</code>
<code>cos**</code>	<code>cosh**</code>	<code>exp**</code>	<code>fabs</code>	<code>floor**</code>	<code>fmod**</code>
<code>labs</code>	<code>ldexp**</code>	<code>log**</code>	<code>log10**</code>	<code>pow**</code>	<code>rand</code>
<code>sin**</code>	<code>sinh**</code>	<code>sqrt**</code>	<code>tan**</code>	<code>tanh**</code>	

* The Stateflow `abs` function goes beyond that of its standard C counterpart with its own built-in functionality. For more information, see “Call the `abs` Function” on page 13-23.

** You can also replace calls to the C Math Library with application-specific implementations for this subset of functions. For more information, see “Replacement of Math Library Functions with Application Implementations” on page 13-24.

When you call these functions, double precision applies unless all the input arguments are explicitly single precision. When a type mismatch occurs, a cast of the input arguments to the expected type replace the original arguments. For example, if you call the `sin` function with an integer argument, a cast of the input argument to a floating-point number of type `double` replaces the original argument.

Note Because the input arguments to the C library functions are first cast to floating-point numbers, function calls with arguments of type `int64` or `uint64` can result in loss of precision.

If you call other C library functions not listed above, include the appropriate `#include...` statement in the **Simulation Target** pane of the Configuration Parameters.

Call the `abs` Function

Interpretation of the Stateflow `abs` function goes beyond the standard C version to include integer and floating-point arguments of all types as follows:

- If `x` is an integer of type `int32` or `int64`, the standard C function `abs` applies to `x`, or `abs(x)`.
- If `x` is an integer of type `int16` or `int8`, the standard C `abs` function applies to a cast of `x` as an integer of type `int32`, or `abs((int32)x)`.
- If `x` is a floating-point number of type `double`, the standard C function `fabs` applies to `x`, or `fabs(x)`.

- If x is a floating-point number of type `single`, the standard C function `fabs` applies to a cast of x as a `double`, or `fabs((double)x)`.
- If x is a fixed-point number, the standard C function `fabs` applies to a cast of the fixed-point number as a `double`, or `fabs((double) Vx)`, where V_x is the real-world value of x .

If you want to use the `abs` function in the strict sense of standard C, cast its argument or return values to integer types. See “Type Cast Operations” on page 13-16.

Note If you declare x in custom code, the standard C `abs` function applies in all cases. For instructions on inserting custom code into charts, see “Reuse Custom Code in Stateflow Charts” on page 31-19.

Call min and max Functions

You can call `min` and `max` by emitting the following macros automatically at the top of generated code.

```
#define min(x1,x2) ((x1) > (x2) ? (x2):(x1))
#define max(x1,x2) ((x1) > (x2) ? (x1):(x2))
```

To allow compatibility with user graphical functions named `min()` or `max()`, generated code uses a mangled name of the following form: `<prefix>_min`. However, if you export `min()` or `max()` graphical functions to other charts in your model, the name of these functions can no longer be emitted with mangled names in generated code and conflict occurs. To avoid this conflict, rename the `min()` and `max()` graphical functions.

Replacement of Math Library Functions with Application Implementations

You can configure the code generator to change the code that it generates for math library functions such that the code meets application requirements. To do this you configure the code generator to apply a code replacement library (CRL) during code generation. If you have an Embedded Coder license, you can develop and apply custom code replacement libraries.

For more information about replacing code, using code replacement libraries that MathWorks provides, see “What Is Code Replacement?” (Simulink Coder) and “Code Replacement Libraries” (Simulink Coder). For information about developing custom code replacement libraries, see “What Is Code Replacement Customization?” (Embedded Coder) and “Code You Can Replace From Simulink Models” (Embedded Coder).

Call Custom C Code Functions

You can specify custom code functions for use in C charts for simulation and C code generation.

- “Specify Custom C Functions for Simulation” on page 13-25
- “Specify Custom C Functions for Code Generation” on page 13-25
- “Guidelines for Calling Custom C Functions in Your Chart” on page 13-25
- “Guidelines for Writing Custom C Functions That Access Input Vectors” on page 13-25
- “Function Call in Transition Action” on page 13-26

- “Function Call in State Action” on page 13-26
- “Pass Arguments by Reference” on page 13-27

Specify Custom C Functions for Simulation

To specify custom C functions for simulation:

- 1 Open the Model Configuration Parameters dialog box.
- 2 Select **Simulation Target**.
- 3 Specify your custom C files, as described in “Access Custom C Code in Nonlibrary Charts” on page 31-4.

Specify Custom C Functions for Code Generation

To specify custom C functions for code generation:

- 1 Open the Model Configuration Parameters dialog box.
- 2 Select **Code Generation > Custom Code**.
- 3 Specify your custom C files, as described in “Integrate External Code for All Charts” (Simulink Coder).

Guidelines for Calling Custom C Functions in Your Chart

- Define a function by its name, any arguments in parentheses, and an optional semicolon.
- Pass parameters to user-written functions using single quotation marks. For example, `func('string')`.
- An action can nest function calls.
- An action can invoke functions that return a scalar value (of type `double` in the case of MATLAB functions and of any type in the case of C user-written functions).

Guidelines for Writing Custom C Functions That Access Input Vectors

- Use the `sizeof` function to determine the length of an input vector.

For example, your custom function can include a for-loop that uses `sizeof` as follows:

```
for(i=0; i < sizeof(input); i++) {
    .....
}
```

- If your custom function uses the value of the input vector length multiple times, include an input to your function that specifies the input vector length.

For example, you can use `input_length` as the second input to a `sum` function as follows:

```
int sum(double *input, double input_length)
```

Your `sum` function can include a for-loop that iterates over all elements of the input vector:

```
for(i=0; i < input_length; i++) {
    .....
}
```

Function Call in Transition Action

Example formats of function calls using transition action notation appear in the following chart.



A function call to `fcn1` occurs with `arg1`, `arg2`, and `arg3` if the following are true:

- `S1` is active.
- Event `e` occurs.
- Condition `c` is true.
- The transition destination `S2` is valid.

The transition action in the transition from `S2` to `S3` shows a function call nested within another function call.

Function Call in State Action

Example formats of function calls using state action notation appear in the following chart.

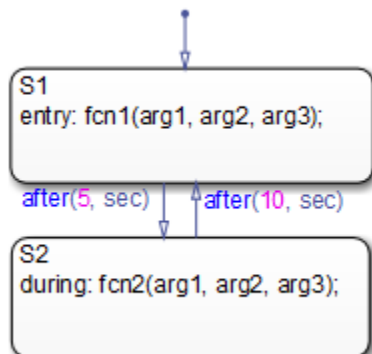

Chart execution occurs as follows:

- 1 When the default transition into `S1` occurs, `S1` becomes active.

- 2 The entry action, a function call to `fcn1` with the specified arguments, executes.
- 3 After 5 seconds of simulation time, S1 becomes inactive and S2 becomes active.
- 4 The during action, a function call to `fcn2` with the specified arguments, executes.
- 5 After 10 seconds of simulation time, S2 becomes inactive and S1 becomes active again.
- 6 Steps 2 through 5 repeat until the simulation ends.

Pass Arguments by Reference

A Stateflow action can pass arguments to a user-written function by reference rather than by value. In particular, an action can pass a pointer to a value rather than the value itself. For example, an action could contain the following call:

```
f(&x);
```

where `f` is a custom-code C function that expects a pointer to `x` as an argument.

If `x` is the name of a data item defined in the Stateflow hierarchy, the following rules apply:

- Do not use pointers to pass data items input from a Simulink model.

If you need to pass an input item by reference, for example, an array, assign the item to a local data item and pass the local item by reference.
- If `x` is a Simulink output data item having a data type other than `double`, the chart property **Use Strong Data Typing with Simulink I/O** must be on (see “Specify Properties for Stateflow Charts” on page 25-2).
- If the data type of `x` is `boolean`, you must turn off the coder option **Use bitsets for storing state configuration**.
- If `x` is an array with its first index property set to 0 (see “Set Data Properties” on page 9-5), then you must call the function as follows.

```
f(&(x[0]));
```

This passes a pointer to the first element of `x` to the function.



- If `x` is an array with its first index property set to a nonzero number (for example, 1), the function must be called in the following way:

```
f(&(x[1]));
```

This passes a pointer to the first element of `x` to the function.

Access MATLAB Functions and Workspace Data in C Charts

Stateflow charts in Simulink models have an action language property that defines the syntax for state and transition actions. An icon in the lower-left corner of the chart canvas indicates the action language for the chart.

-  MATLAB as the action language.
-  C as the action language.

In charts that use C as the action language, you can call built-in MATLAB functions and access MATLAB workspace variables by using the `m1` namespace operator or the `m1` function.

Caution Because MATLAB functions are not available in a target environment, do not use the `m1` namespace operator and the `m1` function if you plan to build a code generation target.

m1 Namespace Operator

For C charts, the `m1` namespace operator uses standard dot (`.`) notation to reference MATLAB variables and functions. For example, the statement `a = m1.x` returns the value of the MATLAB workspace variable `x` to the Stateflow data `a`.

For functions, the syntax is as follows:

```
[return_val1, return_val2, ...] = m1.matfunc(arg1, arg2, ...)
```

For example, the statement `[a, b, c] = m1.matfunc(x, y)` passes the return values from the MATLAB function `matfunc` to the Stateflow data `a`, `b`, and `c`.

If the MATLAB function you call does not require arguments, you must still include the parentheses. If you omit the parentheses, Stateflow software interprets the function name as a workspace variable, which, when not found, generates a run-time error during simulation.

Examples

In these examples, `x`, `y`, and `z` are workspace variables and `d1` and `d2` are Stateflow data:

- `a = m1.sin(m1.x)`

In this example, the MATLAB function `sin` evaluates the sine of `x`, which is then assigned to Stateflow data variable `a`. However, because `x` is a workspace variable, you must use the namespace operator to access it. Hence, `m1.x` is used instead of just `x`.

- `a = m1.sin(d1)`

In this example, the MATLAB function `sin` evaluates the sine of `d1`, which is assigned to Stateflow data variable `a`. Because `d1` is Stateflow data, you can access it directly.

- `m1.x = d1*d2/m1.y`

The result of the expression is assigned to `x`. If `x` does not exist prior to simulation, it is automatically created in the MATLAB workspace.

- `ml.v[5][6][7] = ml.matfunc(ml.x[1][3], ml.y[3], d1, d2, 'string')`

The workspace variables `x` and `y` are arrays. `x[1][3]` is the (1,3) element of the two-dimensional array variable `x`. `y[3]` is the third element of the one-dimensional array variable `y`. The last argument, `'string'`, is a character vector.

The return from the call to `matfunc` is assigned to element (5,6,7) of the workspace array, `v`. If `v` does not exist prior to simulation, it is automatically created in the MATLAB workspace.

ml Function

For C charts, you can use the `ml` function to specify calls to MATLAB functions. The format for the `ml` function call uses this notation:

```
ml(evalString, arg1, arg2,...);
```

`evalString` is an expression that is evaluated in the MATLAB workspace. It contains a MATLAB command (or a set of commands, each separated by a semicolon) to execute along with format specifiers (`%g`, `%f`, `%d`, etc.) that provide formatted substitution of the other arguments (`arg1`, `arg2`, etc.) into `evalString`.

The format specifiers used in `ml` functions are the same as those used in the C functions `printf` and `sprintf`. The `ml` function call is equivalent to calling the MATLAB `eval` function with the `ml` namespace operator if the arguments `arg1`, `arg2`, ... are restricted to scalars or literals in the following command:

```
ml.eval(ml.sprintf(evalString, arg1, arg2,...))
```

Format specifiers used in the `ml` function must either match the data types of the arguments or the arguments must be of types that can be promoted to the type represented by the format specifier.

Stateflow software assumes scalar return values from `ml` namespace operator and `ml` function calls when they are used as arguments in this context. See “How Charts Infer the Return Size for `ml` Expressions” on page 13-33.

Examples

In these examples, `x` is a MATLAB workspace variable, and `d1` and `d2` are Stateflow data:

- `a = ml('sin(x)')`

In this example, the `ml` function calls the MATLAB function `sin` to evaluate the sine of `x` in the MATLAB workspace. The result is then assigned to Stateflow data variable `a`. Because `x` is a workspace variable, and `sin(x)` is evaluated in the MATLAB workspace, you enter it directly in the `evalString` argument (`'sin(x)'`).

- `a = ml('sin(%f)', d1)`

In this example, the MATLAB function `sin` evaluates the sine of `d1` in the MATLAB workspace and assigns the result to Stateflow data variable `a`. Because `d1` is Stateflow data, its value is inserted in the `evalString` argument (`'sin(%f)'`) using the format expression `%f`. This means that if `d1 = 1.5`, the expression evaluated in the MATLAB workspace is `sin(1.5)`.

- `a = ml('matfunc(%g, 'abcdefg', x, %f)', d1, d2)`

In this example, the expression `'matfunc(%g, 'abcdefg', x, %f)'` is the `evalString` shown in the preceding format statement. Stateflow data `d1` and `d2` are inserted into that

expression with the format specifiers %g and %f, respectively. ' 'abcdefg' ' is a literal enclosed with two single pairs of quotation marks because it is part of the evaluation expression, which is already enclosed in single quotation marks.

- `sfmat_44 = ml('rand(4)')`

In this example, a square 4-by-4 matrix of random numbers between 0 and 1 is returned and assigned to the Stateflow data `sf_mat44`. Stateflow data `sf_mat44` must be defined as a 4-by-4 array before simulation. If its size is different, a size mismatch error is generated during run-time.

ml Expressions

For C charts, you can mix `ml` namespace operator and `ml` function expressions along with Stateflow data in larger expressions. The following example squares the sine and cosine of an angle in workspace variable `X` and adds them:

```
ml.power(ml.sin(ml.X),2) + ml('power(cos(X),2)')
```

The first operand uses the `ml` namespace operator to call the `sin` function. Its argument is `ml.X`, since `X` is in the MATLAB workspace. The second operand uses the `ml` function. Because `X` is in the workspace, it appears in the *evalString* expression as `X`. The squaring of each operand is performed with the MATLAB `power` function, which takes two arguments: the value to square, and the power value, 2.

Expressions using the `ml` namespace operator and the `ml` function can be used as arguments for `ml` namespace operator and `ml` function expressions. The following example nests `ml` expressions at three different levels:

```
a = ml.power(ml.sin(ml.X + ml('cos(Y)')),2)
```

In composing your `ml` expressions, follow the levels of precedence set out in “Binary Operations” on page 13-13. Use parentheses around power expressions with the `^` operator when you use them in conjunction with other arithmetic operators.

Stateflow software checks expressions for data size mismatches in your actions during parsing of charts and during run time. Because the return values for `ml` expressions are not known until run time, Stateflow software must infer the size of their return values. See “How Charts Infer the Return Size for `ml` Expressions” on page 13-33.

Which ml Should I Use?

In most cases, the notation of the `ml` namespace operator is more straightforward. However, using the `ml` function call does offer a few advantages:

- Use the `ml` function to dynamically construct workspace variables.

The following flow chart creates four new MATLAB matrices:

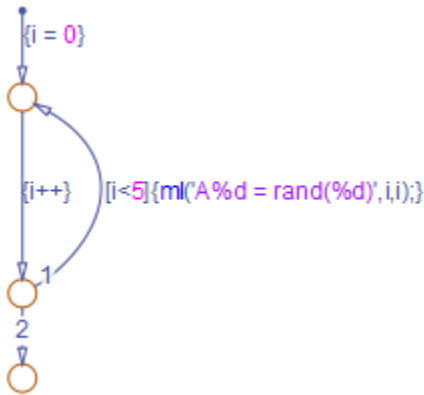

The for loop creates four new matrix variables in the MATLAB workspace. The default transition initializes the Stateflow counter *i* to 0, while the transition segment between the top two junctions increments it by 1. If *i* is less than 5, the transition segment back to the top junction evaluates the `ml` function call `ml('A%d = rand(%d)', i, i)` for the current value of *i*. When *i* is greater than or equal to 5, the transition segment between the bottom two junctions occurs and execution stops.

The transition executes the following MATLAB commands, which create a workspace scalar (*A1*) and three matrices (*A2*, *A3*, *A4*):

```
A1 = rand(1)
A2 = rand(2)
A3 = rand(3)
A4 = rand(4)
```

- Use the `ml` function with full MATLAB notation.

You cannot use full MATLAB notation with the `ml` namespace operator, as the following example shows:

```
ml.A = ml.magic(4)
B = ml('A + A''')
```

This example sets the workspace variable *A* to a magic 4-by-4 matrix using the `ml` namespace operator. Stateflow data *B* is then set to the addition of *A* and its transpose matrix, *A'*, which produces a symmetric matrix. Because the `ml` namespace operator cannot evaluate the expression *A'*, the `ml` function is used instead. However, you can call the MATLAB function `transpose` with the `ml` namespace operator in the following equivalent expression:

```
B = ml.A + ml.transpose(ml.A)
```

As another example, you cannot use arguments with cell arrays or subscript expressions involving colons with the `ml` namespace operator. However, these can be included in an `ml` function call.

ml Data Type

Stateflow data of type `ml` is typed internally with the MATLAB type `mxAarray` for C charts. You can assign (store) any type of data available in the Stateflow hierarchy to a data of type `ml`. These types include any data type defined in the Stateflow hierarchy or returned from the MATLAB workspace with the `ml` namespace operator or `ml` function.

Rules for Using ml Data Type

These rules apply to Stateflow data of type `ml`:

- You can initialize `ml` data from the MATLAB workspace just like other data in the Stateflow hierarchy (see “Initialize Data from the MATLAB Base Workspace” on page 9-19).
- Any numerical scalar or array of `ml` data in the Stateflow hierarchy can participate in any kind of unary operation and any kind of binary operation with any other data in the hierarchy.

If `ml` data participates in any numerical operation with other data, the size of the `ml` data must be inferred from the context in which it is used, just as return data from the `ml` namespace operator and `ml` function are. See “How Charts Infer the Return Size for `ml` Expressions” on page 13-33.

- You cannot define `ml` data with the scope **Constant**.

This option is disabled in the Data properties dialog box and in the Model Explorer for Stateflow data of type `ml`.

- You can use `ml` data to build a simulation target but not to build an embeddable code generation target.
- If data of type `ml` contains an array, you can access the elements of the array via indexing with these rules:
 - a You can index only arrays with numerical elements.
 - b You can index numerical arrays only by their dimension.

In other words, you can access only one-dimensional arrays by a single index value. You cannot access a multidimensional array with a single index value.

- c The first index value for each dimension of an array is 1, and not 0, as in C language arrays.

In the examples that follow, `mldata` is a Stateflow data of type `ml`, `ws_num_array` is a 2-by-2 MATLAB workspace array with numerical values, and `ws_str_array` is a 2-by-2 MATLAB workspace array with character vector values.

```
mldata = ml.ws_num_array; /* OK */
n21 = mldata[2][1]; /* OK for numerical data of type ml */
n21 = mldata[3]; /* NOT OK for 2-by-2 array data */
mldata = ml.ws_str_array; /* OK */
s21 = mldata[2][1]; /* NOT OK for character vector data of type ml*/
```

- `ml` data cannot have a scope outside a C chart; that is, you cannot define the scope of `ml` data as **Input from Simulink** or **Output to Simulink**.

Place Holder for Workspace Data

Both the `ml` namespace operator and the `ml` function can access data directly in the MATLAB workspace and return it to a C chart. However, maintaining data in the MATLAB workspace can present Stateflow users with conflicts with other data already resident in the workspace. Consequently, with the `ml` data type, you can maintain `ml` data in a chart and use it for MATLAB computations in C charts.

As an example, in the following statements, `mldata1` and `mldata2` are Stateflow data of type `ml`:

```
mldata1 = ml.rand(3);
mldata2 = ml.transpose(mldata1);
```

In the first line of this example, `mldata1` receives the return value of the MATLAB function `rand`, which, in this case, returns a 3-by-3 array of random numbers. Note that `mldata1` is not specified as an array or sized in any way. It can receive any MATLAB workspace data or the return of any MATLAB function because it is defined as a Stateflow data of type `m1`.

In the second line of the example, `mldata2`, also of Stateflow data type `m1`, receives the transpose matrix of the matrix in `mldata1`. It is assigned the return value of the MATLAB function `transpose` in which `mldata1` is the argument.

Note the differences in notation if the preceding example were to use MATLAB workspace data (`wsdata1` and `wsdata2`) instead of Stateflow `m1` data to hold the generated matrices:

```
m1.wsdata1 = m1.rand(3);
m1.wsdata2 = m1.transpose(m1.wsdata1);
```

In this case, each workspace data must be accessed through the `m1` namespace operator.

How Charts Infer the Return Size for m1 Expressions

In C charts, Stateflow expressions using the `m1` namespace operator and the `m1` function evaluate in the MATLAB workspace at run time. The actual size of the data returned from the following expression types is known only at run time:

- MATLAB workspace data or functions using the `m1` namespace operator or the `m1` function call

For example, the size of the return values from the expressions `m1.var`, `m1.func()`, or `m1(evalString, arg1, arg2, ...)`, where `var` is a MATLAB workspace variable and `func` is a MATLAB function, cannot be known until run-time.

- Stateflow data of type `m1`
- Graphical functions that return Stateflow data of type `m1`

When these expressions appear in actions, Stateflow code generation creates temporary data to hold intermediate returns for evaluation of the full expression of which they are a part. Because the size of these return values is unknown until run time, Stateflow software must employ context rules to infer the sizes for creation of the temporary data.

During run time, if the actual returned value from one of these commands differs from the inferred size of the temporary variable that stores it, a size mismatch error appears. To prevent run-time errors, use the following guidelines to write actions with MATLAB commands or `m1` data:

Guideline	Example
Return sizes of MATLAB commands or data in an expression must match return sizes of peer expressions.	In the expression <code>m1.func() * (x + m1.y)</code> , if <code>x</code> is a 3-by-2 matrix, then <code>m1.func()</code> and <code>m1.y</code> are also assumed to evaluate to 3-by-2 matrices. If either returns a value of different size (other than a scalar), an error results during run-time.

Guideline		Example
<p>Expressions that return a scalar never produce an error.</p> <p>You can combine matrices and scalars in larger expressions because MATLAB commands use scalar expansion.</p>		<p>In the expression $m1.x + y$, if y is a 3-by-2 matrix and $m1.x$ returns a scalar, the resulting value is the result of adding the scalar value of $m1.x$ to every member of y to produce a matrix with the size of y, that is, a 3-by-2 matrix.</p> <p>The same rule applies to subtraction (-), multiplication (*), division (/), and any other binary operations.</p>
<p>MATLAB commands or Stateflow data of type $m1$ can be members of these independent levels of expression, for which resolution of return size is necessary:</p>	<p>Arguments</p> <p>The expression for each function argument is a larger expression for which the return size of MATLAB commands or Stateflow data of type $m1$ must be determined.</p>	<p>In the expression $z + func(x + m1.y)$, the size of $m1.y$ is independent of the size of z, because $m1.y$ is used at the function argument level. However, the return size for $func(x + m1.y)$ must match the size of z, because they are both at the same expression level.</p>
	<p>Array indices</p> <p>The expression for an array index is an independent level of expression that must be scalar in size.</p>	<p>In the expression $x + array[y]$, the size of y is independent of the size of x because y and x are at different levels of expression. Also, y must be a scalar.</p>
<p>The return size for an indexed array element access must be a scalar.</p>		<p>The expression $x[1][1]$, where x is a 3-by-2 array, must evaluate to a scalar.</p>
<p>MATLAB command or data elements used in an expression for the input argument of a MATLAB function called through the $m1$ namespace operator are resolved for size. This resolution uses the rule for peer expressions (preceding rule 1) for the expression itself, because no size definition prototype is available.</p>		<p>In the function call $m1.func(x + m1.y)$, if x is a 3-by-2 array, $m1.y$ must return a 3-by-2 array or a scalar.</p>
<p>MATLAB command or data elements used for the input argument for a graphical function in an expression are resolved for size by the function prototype.</p>		<p>If the graphical function $gfunc$ has the prototype $gfunc(arg1)$, where $arg1$ is a 2-by-3 Stateflow data array, the calling expression, $gfunc(m1.y + x)$, requires that both $m1.y$ and x evaluate to 2-by-3 arrays (or scalars) during run-time.</p>
<p>$m1$ function calls can take only scalar or character vector literal arguments. Any MATLAB command or data that specifies an argument for the $m1$ function must return a scalar value.</p>		<p>In the expression $a = m1('sin(x)')$, the $m1$ function calls the MATLAB function <code>sin</code> to evaluate the sine of x in the MATLAB workspace. Stateflow data variable a stores that result.</p>

Guideline	Example
<p>In an assignment, the size of the right-hand expression must match the size of the left-hand expression, with one exception. If the left-hand expression is a single MATLAB variable, such as <code>m1.x</code>, or Stateflow data of type <code>m1</code>, the right-hand expression determines the sizes of both expressions.</p>	<p>In the expression <code>s = m1.func(x)</code>, where <code>x</code> is a 3-by-2 matrix and <code>s</code> is scalar Stateflow data, <code>m1.func(x)</code> must return a scalar to match the left-hand expression, <code>s</code>. However, in the expression <code>m1.y = x + s</code>, where <code>x</code> is a 3-by-2 data array and <code>s</code> is scalar, the left-hand expression, workspace variable <code>y</code>, is assigned the size of a 3-by-2 array to match the size of the right-hand expression, <code>x+s</code>, a 3-by-2 array.</p>
<p>In an assignment, Stateflow column vectors on the left-hand side are compatible with MATLAB row or column vectors of the same size on the right-hand side.</p> <p>A matrix you define with a row dimension of 1 is considered a row vector. A matrix you define with one dimension or with a column dimension of 1 is considered a column vector.</p>	<p>In the expression <code>s = m1.func()</code>, where <code>m1.func()</code> returns a 1-by-3 matrix, if <code>s</code> is a vector of size 3, the assignment is valid.</p>
<p>If you cannot resolve the return size of MATLAB command or data elements in a larger expression by any of the preceding rules, they are assumed to return scalar values.</p>	<p>In the expression <code>m1.x = m1.y + m1.z</code>, none of the preceding rules can be used to infer a common size among <code>m1.x</code>, <code>m1.y</code>, and <code>m1.z</code>. In this case, both <code>m1.y</code> and <code>m1.z</code> are assumed to return scalar values. Even if <code>m1.y</code> and <code>m1.z</code> return matching sizes at run-time, if they return nonscalar values, a size mismatch error results.</p>
<p>The preceding rules for resolving the size of member MATLAB commands or Stateflow data of type <code>m1</code> in a larger expression apply only to cases in which numeric values are expected for that member. For nonnumeric returns, a run-time error results.</p>	<p>The expression <code>x + m1.str</code>, where <code>m1.str</code> is a character vector workspace variable, produces a run-time error stating that <code>m1.str</code> is not a numeric type.</p>
<p>Note Member MATLAB commands or data of type <code>m1</code> in a larger expression are limited to numeric values (scalar or array) only if they participate in numeric expressions.</p>	

Special cases exist, in which no size checking occurs to resolve the size of MATLAB command or data expressions that are part of larger expressions. Use of the following expressions does not require enforcement of size checking at run-time:

- `m1.var`
- `m1.func()`
- `m1(evalString, arg1, arg2, ...)`
- Stateflow data of type `m1`
- Graphical function returning a Stateflow data of type `m1`

In these cases, assignment of a return to the left-hand side of an assignment statement or a function argument occurs without checking for a size mismatch between the two:

- An assignment in which the left-hand side is a MATLAB workspace variable

For example, in the expression `m1.x = m1.y`, `m1.y` is a MATLAB workspace variable of any size and type (structure, cell array, character vector, and so on).

- An assignment in which the left-hand side is a data of type `m1`

For example, in the expression `m_x = m1.func()`, `m_x` is a Stateflow data of type `m1`.

- Input arguments of a MATLAB function

For example, in the expression `m1.func(m_x, m1.x, gfunc())`, `m_x` is a Stateflow data of type `m1`, `m1.x` is a MATLAB workspace variable of any size and type, and `gfunc()` is a Stateflow graphical function that returns a Stateflow data of type `m1`. Although size checking does not occur for the input type, if the passed-in data is not of the expected type, an error results from the function call `m1.func()`.

- Arguments for a graphical function that are specified as Stateflow data of type `m1` in its prototype statement

Note If you replace the inputs in the preceding cases with non-MATLAB numeric Stateflow data, conversion to an `m1` type occurs.

Broadcast Local Events to Synchronize Parallel States

Directed Event Broadcasting

You can broadcast events directly from one state to another to synchronize parallel (AND) states in the same chart. Local events are supported only in Stateflow charts in Simulink models. The following rules apply:

- The receiving state must be active during the event broadcast.
- An action in one chart cannot broadcast events to states in another chart.

Using a directed local event broadcast provides the following benefits over an undirected broadcast:

- Prevents unwanted recursion during simulation.
- Improves the efficiency of generated code.

For information about avoiding unwanted recursion, see “Avoid Unwanted Recursion in a Chart” on page 33-39.

Directed Local Event Broadcast Using `send`

The format of a directed local event broadcast with `send` is:

```
send(event_name, state_name)
```

where `event_name` is broadcast to `state_name` and any offspring of that state in the hierarchy. The event you send must be visible to both the sending state and the receiving state (`state_name`).

The `state_name` argument can include a full hierarchy path to the state. For example, if the state A contains the state A1, send an event E to state A1 with the following broadcast:

```
send(E, A.A1)
```

Tip Do not include the chart name in the full hierarchy path to a state.

The following example of a directed local event broadcast uses the `send(event_name, state_name)` syntax.

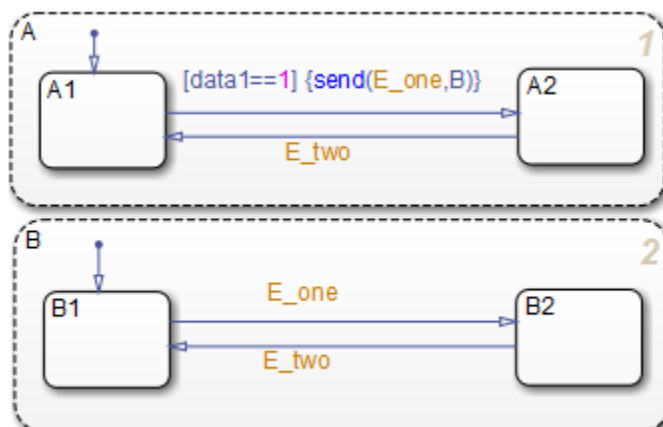

In this example, event `E_one` belongs to the chart and is visible to both A and B. See “Directed Event Broadcast Using Send” on page B-39 for more information on the semantics of this notation.

Directed Local Event Broadcast Using Qualified Event Names

The format of a directed local event broadcast using qualified event names is:

```
send(state_name.event_name)
```

where `event_name` is broadcast to its owning state (`state_name`) and any offspring of that state in the hierarchy. The event you send is visible only to the receiving state (`state_name`).

The `state_name` argument can also include a full hierarchy path to the receiving state. Do not use the chart name in the full path name of the state.

The following example shows the use of a qualified event name in a directed local event broadcast.

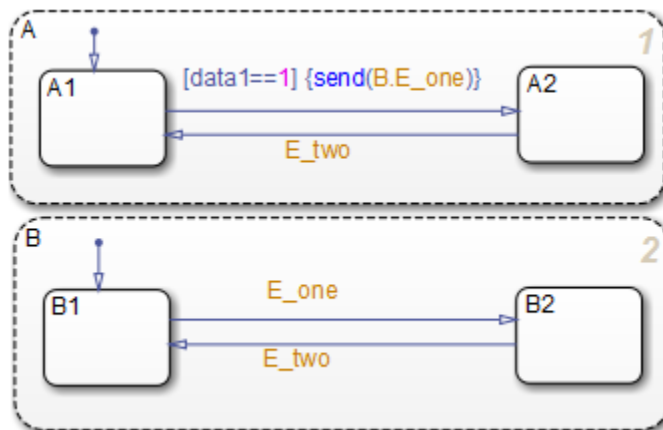

In this example, event `E_one` belongs to state B and is visible only to that state. See “Directed Event Broadcast Using Qualified Event Name” on page B-40 for more information on the semantics of this notation.

Diagnostic for Detecting Undirected Local Event Broadcasts

If you have *undirected* local event broadcasts in state actions or condition actions in your chart, a warning appears by default during simulation. Examples of state actions with undirected local event broadcasts include:

- `entry: send(E1)`, where `E1` is a local event in the chart
- `exit: E2`, where `E2` is a local event in the chart

You can control the level of diagnostic action for undirected local event broadcasts in the **Diagnostics > Stateflow** pane of the Model Configuration Parameters dialog box. Set the **Undirected event broadcasts** diagnostic to `none`, `warning`, or `error`. For more information, see the documentation for the “Undirected event broadcasts” (Simulink) diagnostic.

See Also

`send`

More About

- “Synchronize Model Components by Broadcasting Events” on page 11-2
- “Set Properties for an Event” on page 11-5
- “Broadcast Local Events in Parallel States” on page B-39

Control Chart Execution by Using Temporal Logic

Temporal logic controls the execution of a chart in terms of time. In state actions and transitions, you can use two types of temporal logic:

- Event-based temporal logic tracks recurring events. You can use any explicit or implicit event as a base event.
- Absolute-time temporal logic tracks the elapsed time since a state became active. The timing for absolute-time temporal logic operators depends on the type of Stateflow chart:
 - Charts in a Simulink model define absolute-time temporal logic in terms of simulation time.
 - Standalone charts in MATLAB define absolute-time temporal logic in terms of wall-clock time, which is limited to 1 millisecond precision.

Temporal Logic Operators

To define the behavior of a Stateflow chart based on temporal logic, use the operators listed in this table. These operators can appear in:

- State on actions
- Actions on transition paths that originate from a state

Each temporal logic operator has an associated state, which is the state in which the action appears or from which the transition path originates. The Stateflow chart resets the counter used by each operator every time that the associated state reactivates.

Operator	Syntax	Description	Example
after	<code>after(n,E)</code> n is a positive integer or an expression that evaluates to a positive integer value. E is the base event for the operator.	Returns <code>true</code> if the event E has occurred at least n times since the associated state became active. Otherwise, the operator returns <code>false</code> .	Display a status message when the chart processes a broadcast of the event E, starting on the third broadcast of E after the state became active. <pre>on after(3,E): disp('ON');</pre> Transition out of the associated state when the chart processes a broadcast of the event E, starting on the fifth broadcast of E after the state became active. <code>after(5,E)</code>

Operator	Syntax	Description	Example
	<p><code>after(n,tick)</code></p> <p><code>n</code> is a positive integer or an expression that evaluates to a positive integer value.</p>	<p>Returns <code>true</code> if the chart has woken up at least <code>n</code> times since the associated state became active. Otherwise, the operator returns <code>false</code>.</p> <p>The implicit event <code>tick</code> is not supported when a Stateflow chart in a Simulink model has input events. For more information, see “Control Chart Behavior by Using Implicit Events” on page 11-23.</p>	<p>Transition out of the associated state when the chart wakes up for at least the seventh time since the state became active, but only if the variable <code>temp</code> is greater than 98.6.</p> <pre>after(7,tick)[temp > 98.6]</pre>
	<p><code>after(n,sec)</code></p> <p><code>after(n,msec)</code></p> <p><code>after(n,usec)</code></p> <p><code>n</code> is a positive real number or an expression that evaluates to a positive real value.</p>	<p>Returns <code>true</code> if at least <code>n</code> units of time have elapsed since the associated state became active. Otherwise, the operator returns <code>false</code>.</p> <p>In charts in a Simulink model, specify time in seconds (<code>sec</code>), milliseconds (<code>msec</code>), or microseconds (<code>usec</code>).</p> <p>In standalone charts in MATLAB, specify time in seconds (<code>sec</code>). The operator creates a MATLAB <code>timer</code> object that generates an implicit event to wake up the chart. MATLAB <code>timer</code> objects are limited to 1 millisecond precision. For more information, see “Events in Standalone Charts” on page 3-53.</p>	<p>Set the <code>temp</code> variable to <code>LOW</code> every time that the chart wakes up, starting when the associated state is active for at least 12.3 seconds.</p> <pre>on after(12.3,sec): temp = LOW;</pre>
<code>at</code>	<p><code>at(n,E)</code></p> <p><code>n</code> is a positive integer or an expression that evaluates to a positive integer value.</p> <p><code>E</code> is the base event for the operator.</p>	<p>Returns <code>true</code> if the event <code>E</code> has occurred exactly <code>n</code> times since the associated state became active. Otherwise, the operator returns <code>false</code>.</p>	<p>Display a status message when the chart processes the third broadcast of the event <code>E</code> after the state became active.</p> <pre>on at(3,E): disp('ON');</pre> <p>Transition out of the associated state when the chart processes the fifth broadcast of the event <code>E</code> after the state became active.</p> <pre>at(5,E)</pre>

Operator	Syntax	Description	Example
	<p><code>at(n,tick)</code></p> <p><code>n</code> is a positive integer or an expression that evaluates to a positive integer value.</p>	<p>Returns <code>true</code> if the chart has woken up exactly <code>n</code> times since the associated state became active. Otherwise, the operator returns <code>false</code>.</p> <p>The implicit event <code>tick</code> is not supported when a Stateflow chart in a Simulink model has input events. For more information, see “Control Chart Behavior by Using Implicit Events” on page 11-23.</p>	<p>Transition out of the associated state when the chart wakes up for the seventh time since the state became active, but only if the variable <code>temp</code> is greater than 98.6.</p> <pre>at(7,tick)[temp > 98.6]</pre>
	<p><code>at(n,sec)</code></p> <p><code>n</code> is a positive real number or an expression that evaluates to a positive real value.</p>	<p>Returns <code>true</code> if exactly <code>n</code> seconds have elapsed since the associated state became active. Otherwise, the operator returns <code>false</code>.</p> <p>Using <code>at</code> as an absolute-time temporal logic operator is supported only in standalone charts in MATLAB. The operator creates a MATLAB <code>timer</code> object that generates an implicit event to wake up the chart. MATLAB <code>timer</code> objects are limited to 1 millisecond precision. For more information, see “Events in Standalone Charts” on page 3-53.</p>	<p>Set the <code>temp</code> variable to <code>HIGH</code> if the state has been active for exactly 12.3 seconds.</p> <pre>on at(12.3,sec): temp = HIGH;</pre>
before	<p><code>before(n,E)</code></p> <p><code>n</code> is a positive integer or an expression that evaluates to a positive integer value.</p> <p><code>E</code> is the base event for the operator.</p>	<p>Returns <code>true</code> if the event <code>E</code> has occurred fewer than <code>n</code> times since the associated state became active. Otherwise, the operator returns <code>false</code>.</p> <p>The temporal logic operator <code>before</code> is not supported in standalone charts in MATLAB.</p>	<p>Display a status message when the chart processes the first and second broadcasts of the event <code>E</code> after the state became active.</p> <pre>on before(3,E): disp('ON');</pre> <p>Transition out of the associated state when the chart processes a broadcast of the event <code>E</code>, but only if the state has been active for fewer than five broadcasts of <code>E</code>.</p> <pre>before(5,E)</pre>

Operator	Syntax	Description	Example
	<p><code>before(n, tick)</code></p> <p><code>n</code> is a positive integer or an expression that evaluates to a positive integer value.</p>	<p>Returns <code>true</code> if the chart has woken up fewer than <code>n</code> times since the associated state became active. Otherwise, the operator returns <code>false</code>.</p> <p>The implicit event <code>tick</code> is not supported when a Stateflow chart in a Simulink model has input events. For more information, see “Control Chart Behavior by Using Implicit Events” on page 11-23.</p> <p>The temporal logic operator <code>before</code> is not supported in standalone charts in MATLAB.</p>	<p>Transition out of the associated state when the chart wakes up, but only if the variable <code>temp</code> is greater than 98.6 and the chart has woken up fewer than seven times since the state became active.</p> <pre>before(7, tick) [temp > 98.6]</pre>
	<p><code>before(n, sec)</code></p> <p><code>before(n, msec)</code></p> <p><code>before(n, usec)</code></p> <p><code>n</code> is a positive real number or an expression that evaluates to a positive real value.</p>	<p>Returns <code>true</code> if fewer than <code>n</code> units of time have elapsed since the associated state became active. Otherwise, the operator returns <code>false</code>.</p> <p>Specify time in seconds (<code>sec</code>), milliseconds (<code>msec</code>), or microseconds (<code>usec</code>).</p> <p>The temporal logic operator <code>before</code> is not supported in standalone charts in MATLAB.</p>	<p>Set the <code>temp</code> variable to <code>MED</code> every time that the chart wakes up, but only if the associated state has been active for fewer 12.3 seconds.</p> <pre>on before(12.3, sec): temp = MED;</pre>
every	<p><code>every(n, E)</code></p> <p><code>n</code> is a positive integer or an expression that evaluates to a positive integer value.</p> <p><code>E</code> is the base event for the operator.</p>	<p>Returns <code>true</code> at every n^{th} occurrence of the event <code>E</code> since the associated state became active. Otherwise, the operator returns <code>false</code>.</p>	<p>Display a status message when the chart processes every third broadcast of the event <code>E</code> after the state became active.</p> <pre>on every(3, E): disp('ON');</pre> <p>Transition out of the associated state when the chart processes every fifth broadcast of the event <code>E</code> after the state became active.</p> <pre>every(5, E)</pre>

Operator	Syntax	Description	Example
	<p><code>every(n, tick)</code></p> <p><code>n</code> is a positive integer or an expression that evaluates to a positive integer value.</p>	<p>Returns <code>true</code> at every <code>n</code>th time that the chart wakes up since the associated state became active. Otherwise, the operator returns <code>false</code>.</p> <p>The implicit event <code>tick</code> is not supported when a Stateflow chart in a Simulink model has input events. For more information, see “Control Chart Behavior by Using Implicit Events” on page 11-23.</p>	<p>Transition out of the associated state every seventh <code>tick</code> event since the state became active, but only if the variable <code>temp</code> is greater than 98.6.</p> <pre>every(7, tick) [temp > 98.6]</pre>
	<p><code>every(n, sec)</code></p> <p><code>n</code> is a positive real number or an expression that evaluates to a positive real value.</p>	<p>Returns <code>true</code> every <code>n</code> seconds since the associated state became active. Otherwise, the operator returns <code>false</code>.</p> <p>Using <code>every</code> as an absolute-time temporal logic operator is supported only in standalone charts in MATLAB. The operator creates a MATLAB <code>timer</code> object that generates an implicit event to wake up the chart. MATLAB <code>timer</code> objects are limited to 1 millisecond precision. For more information, see “Events in Standalone Charts” on page 3-53.</p>	<p>Increment the <code>temp</code> variable by 5 every 12.3 seconds that the state is active.</p> <pre>on every(12.3, sec): temp = temp+5;</pre>
temporal Count	<p><code>temporalCount(E)</code></p> <p><code>E</code> is the base event for the operator.</p>	<p>Returns the number of occurrences of the event <code>E</code> since the associated state became active.</p> <p>Using <code>temporalCount</code> as an event-based temporal logic operator is not supported in standalone charts in MATLAB.</p>	<p>Access successive elements of the array <code>M</code> each time that the chart processes a broadcast of the event <code>E</code>.</p> <pre>on E: y = M[temporalCount(E)];</pre>
	<p><code>temporalCount(tick)</code></p>	<p>Returns the number of times that the chart has woken up since the associated state became active.</p> <p>The implicit event <code>tick</code> is not supported when a Stateflow chart in a Simulink model has input events.</p> <p>Using <code>temporalCount</code> as an event-based temporal logic operator is not supported in standalone charts in MATLAB.</p>	<p>Store the value of the input data <code>u</code> in successive elements of the array <code>M</code>.</p> <pre>en: M[0] = u; du: M[temporalCount(tick)] = u;</pre>

Operator	Syntax	Description	Example
	<code>temporalCount(sec)</code> <code>temporalCount(msec)</code> <code>temporalCount(usec)</code>	<p>Returns the length of time that has elapsed since the associated state became active.</p> <p>Specify time in seconds (<code>sec</code>), milliseconds (<code>msec</code>), or microseconds (<code>usec</code>).</p>	<p>Store the number of milliseconds between activation and deactivation of the state.</p> <pre>exit: y = temporalCount(msec);</pre>
elapsed	<code>elapsed(sec)</code>	<p>Equivalent to <code>temporalCount(sec)</code>. Returns the length of time that has elapsed since the associated state became active.</p>	<p>Store the number of seconds that the state has been active.</p> <pre>en,du: y = elapsed(sec);</pre>
count	<code>count(C)</code> C is an expression that evaluates to <code>true</code> or <code>false</code> .	<p>Returns the number of times that the chart has woken up since the conditional expression C became <code>true</code> and the associated state became active.</p>	<p>Store the number of chart executions since the variable x has been greater than 5.</p> <pre>exit: y = count(x>5)</pre>
		<p>The value of the count operator is reset if the conditional expression becomes <code>false</code> or if the associated state becomes inactive.</p> <p>In charts in a Simulink model, the value of count depends on the step size. Changing the solver or step size for the model affects the results produced by the count operator.</p>	<p>Transition out of the associated state when the variable x has been greater than or equal to 2 for longer than 5 chart executions.</p> <pre>[count(x>=2) > 5]</pre>
duration	<code>duration(C)</code> C is an expression that evaluates to <code>true</code> or <code>false</code> .	<p>Returns the number of seconds since the conditional expression C became <code>true</code> and the associated state became active.</p> <p>The value of the duration operator is reset if the conditional expression becomes <code>false</code> or if the associated state becomes inactive.</p>	<p>Transition out of the state when the variable x has been greater than or equal to 0 for longer than 0.1 seconds.</p> <pre>[duration(x>=0) > 0.1]</pre>

You can use quotation marks to enclose the keywords 'tick', 'sec', 'msec', and 'usec'. For example, `after(5, 'tick')` is equivalent to `after(5, tick)`.

Note The temporal logic operators `after`, `at`, `before`, and `every` compare the threshold `n` to an internal counter of integer type. If `n` is a fixed-point number defined by either a slope that is not an integer power of two or a nonzero bias, then the comparison can yield unexpected results due to rounding. For more information, see “Relational Operations for Fixed-Point Data” on page 23-19.

Examples of Temporal Logic

Define Time Delays

This example shows how to define two absolute time delays in a continuous-time chart.

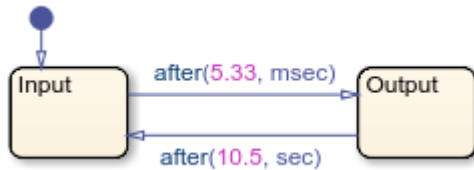

The execution of the chart follows these steps:

- 1 When the chart awakens, the state **Input** activates first.
- 2 After 5.33 milliseconds of simulation time, the transition from **Input** to **Output** occurs.
- 3 The state **Input** becomes inactive and the state **Output** becomes active.
- 4 After 10.5 seconds of simulation time, the transition from **Output** to **Input** occurs.
- 5 The state **Output** becomes inactive and the state **Input** becomes active.

Steps 2 through 5 are repeated until the simulation ends.

If a chart has a discrete sample time, any action in the chart occurs at integer multiples of this sample time. For example, suppose that you change the configuration parameters so that the Simulink® solver uses a fixed step of size 0.1 seconds. Then the first transition from state **Input** to state **Output** occurs at $t = 0.1$ seconds. This behavior applies because the solver does not wake the chart at exactly $t = 5.33$ milliseconds. Instead, the solver wakes the chart at integer multiples of 0.1 seconds, such as $t = 0.0$ and 0.1 seconds.

Detect Elapsed Time

In this example, a Step block provides a unit step input to a Stateflow chart.

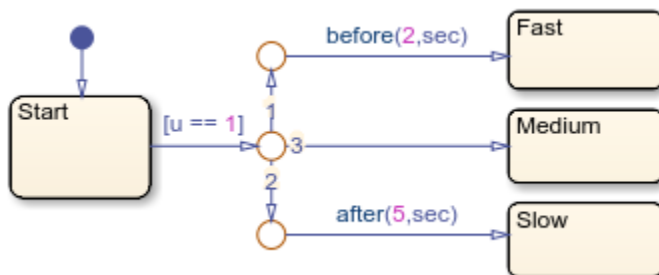

The chart determines when the input u equals 1:

- If the input equals 1 before $t = 2$ seconds, a transition occurs from **Start** to **Fast**.
- If the input equals 1 between $t = 2$ and $t = 5$ seconds, a transition occurs from **Start** to **Medium**.

- If the input equals 1 after $t = 5$ seconds, a transition occurs from Start to Slow.

Use Absolute-Time Temporal Logic in an Enabled Subsystem

You can use absolute-time temporal logic in a chart that resides in a conditionally executed subsystem. When the subsystem is disabled, the chart becomes inactive and the temporal logic operator pauses while the chart is asleep. The operator does not continue to count simulation time until the subsystem is reenabled and the chart is awake.

This model has an enabled subsystem with the **States when enabling** parameter set to held.

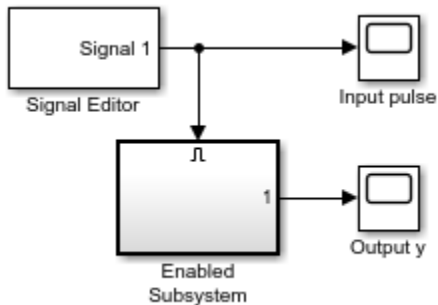

The subsystem contains a chart that uses the `after` operator to trigger a transition.



The Signal Editor block provides an input signal with these characteristics:

- The signal enables the subsystem at $t = 0$.
- The signal disables the subsystem at $t = 2$.
- The signal reenables the subsystem at $t = 6$.

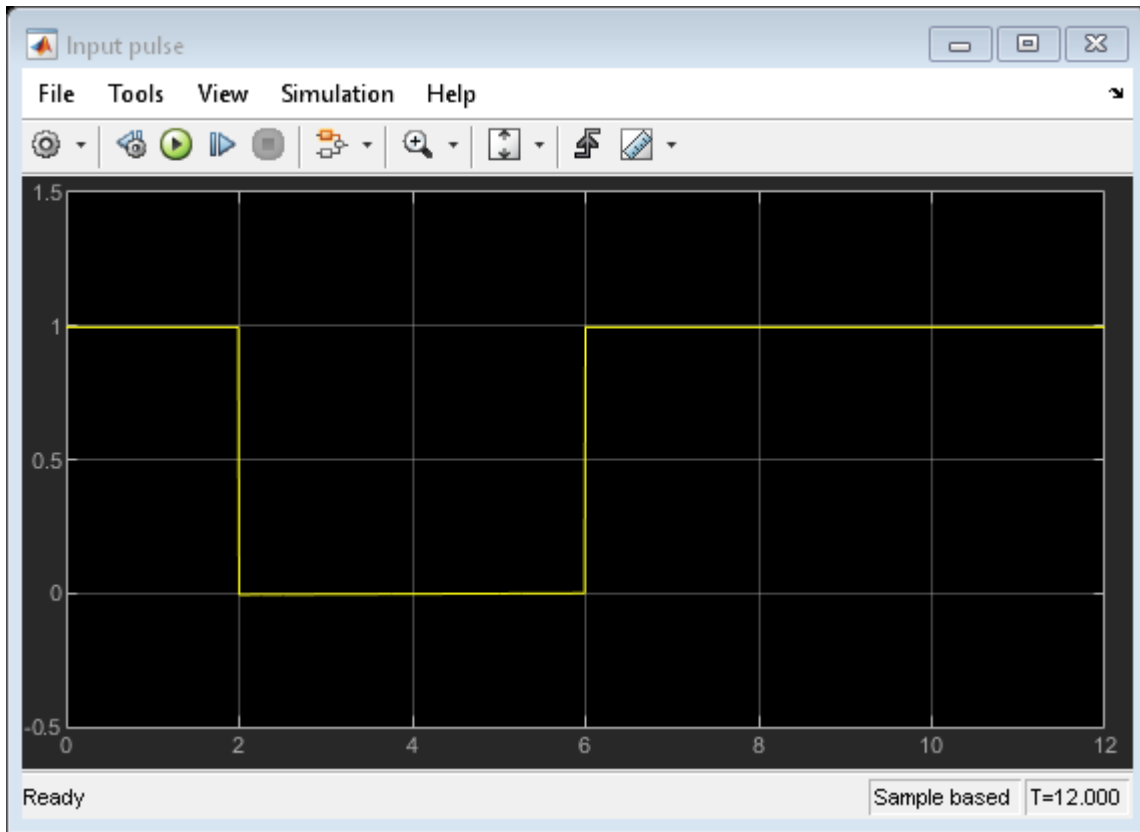

This graph shows the total time elapsed in the chart. When the input signal enables the subsystem at time $t = 0$, state A becomes active. While the system is enabled, the elapsed time increases. When the subsystem is disabled at $t = 2$, the chart goes to sleep and the elapsed time stops increasing. For $2 < t < 6$, the elapsed time stays frozen at 2 seconds because the system is disabled. When the chart wakes up at $t = 6$, elapsed time starts to increase again.

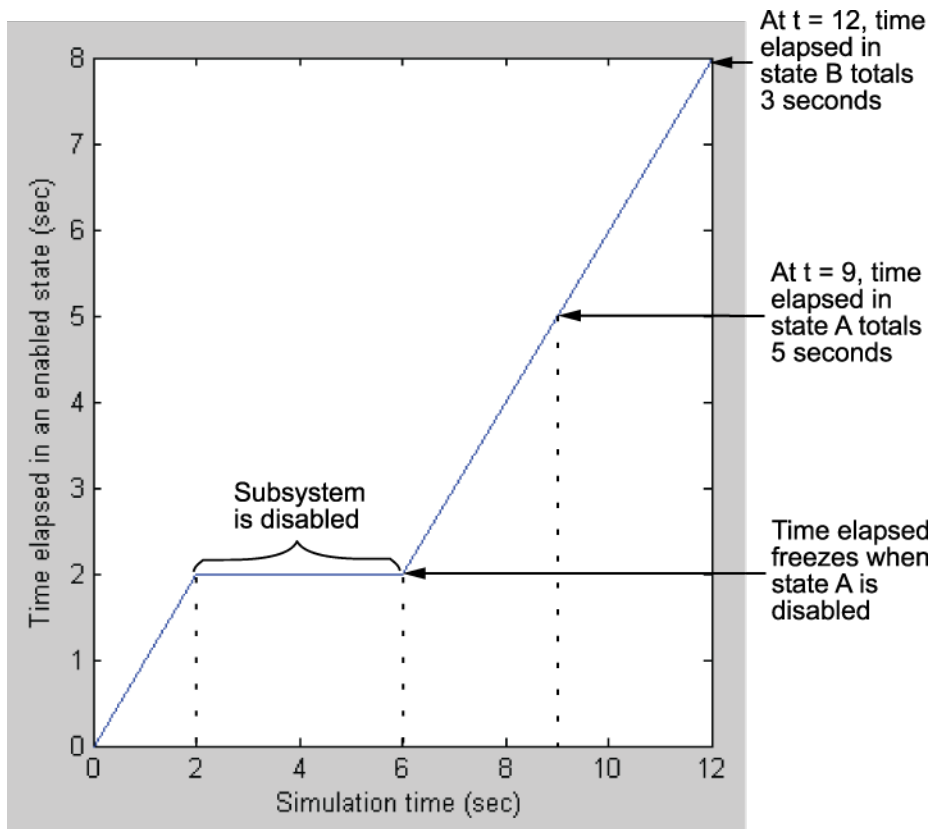

The transition from state A to state B depends on the elapsed time while state A is active, not on the simulation time. Therefore, the transition occurs at $t = 9$, when the elapsed time in state A equals 5 seconds. When the transition occurs, the output value y changes from 0 to 1.

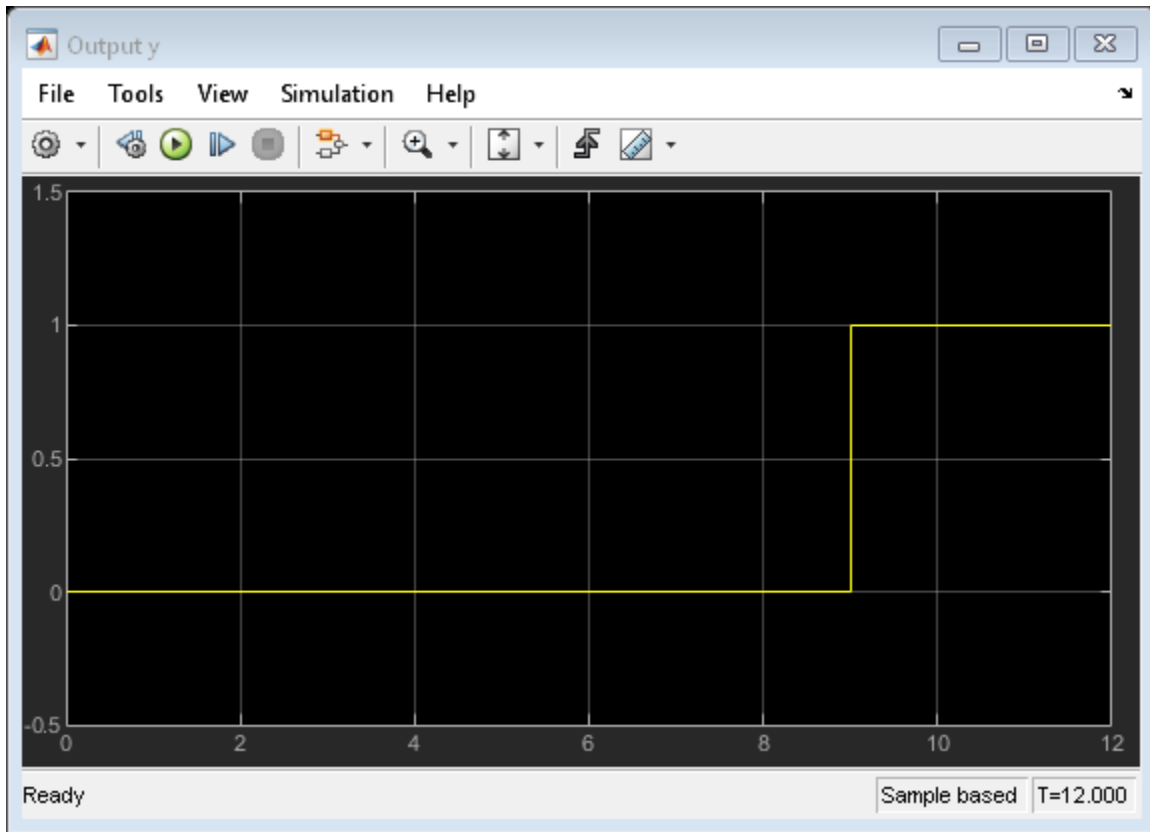

This model behavior applies only to subsystems where you set the Enable block parameter **States when enabling** to held. If you set the parameter to reset, the chart reinitializes completely when the subsystem is reenabled. Default transitions execute and any temporal logic counters reset to 0.

Notation for Event-Based Temporal Logic in Transitions

In Stateflow charts in Simulink models, the operators *after*, *at*, and *before* support two distinct notations to express event-based temporal logic in a transition.

- Trigger notation defines a transition that depends only on the base event for the temporal logic operator. Trigger notation follows this syntax:

$$\text{temporalLogicOperator}(n,E)[C]$$

where:

- *temporalLogicOperator* is a Boolean temporal logic operator.
- *n* is the occurrence count of the operator.
- *E* is the base event of the operator.
- *C* is an optional condition expression.

When you use trigger notation, the transition can occur only when the chart processes a broadcast of the base event *E*.

- Conditional notation defines a transition that depends on base and nonbase events. Conditional notation follows this syntax:

$F[\text{temporalLogicOperator}(n,E) \ \&\& \ C]$

where:

- *temporalLogicOperator* is a Boolean temporal logic operator.
- *n* is the occurrence count of the operator.
- *E* is the base event of the operator.
- *F* is an optional nonbase event.
- *C* is an optional condition expression.

When you use conditional notation with a nonbase event *F*, the transition can occur only when the chart processes a broadcast of *F*. If you omit the nonbase event, the transition can occur when the chart is processing any explicit or implicit event.

Conditional notation for temporal logic operators is not supported in standalone charts in MATLAB.

For example, this transition label uses trigger notation to indicate a transition out of the associated state when the chart processes a broadcast of the base event *E*, starting on the fifth broadcast of *E* after the state became active.

`after(5,E)`

In contrast, this transition label uses conditional notation to indicate a transition out of the associated state when the state has been active for at least five broadcasts of the base event *E*, even if the chart is not processing a broadcast of *E*.

`[after(5,E)]`

Note The operator `every` supports trigger and conditional notations. However, both notations are equivalent for this operator. The transition labels `every(5,E)` and `[every(5,E)]` indicate a transition out of the associated state when the chart processes the k^{th} broadcast of the base event *E* after the state became active, where *k* is a multiple of five.

Best Practices for Temporal Logic

Do Not Use Temporal Logic on Transition Paths Without A Source State

The value of a temporal logic operator depends on when its associated state became active. To ensure that every temporal logic operator has a unique associated state, only use these operators in:

- State on actions
- Actions on transition paths that originate from a state

Do not use temporal logic operators on default transitions or on transitions in graphical functions because these transitions do not originate from a state.

Use Absolute-time Temporal Logic Instead of tick in Charts in Simulink Models

In charts in a Simulink model, the value of delay expressions that use absolute-time temporal logic are semantically independent of the sample time of the model. In contrast, delay expressions that use temporal logic based on the implicit event `tick` depend on the step size used by the Simulink solver.

Additionally, absolute-time temporal logic is supported in charts that have input events. The implicit event tick is not supported when a Stateflow chart in a Simulink model has input events.

Do Not Use at for Absolute-Time Temporal Logic in Charts in Simulink Models

In charts in a Simulink model, using `at` as an absolute-time temporal logic operator is not supported. Instead, use the `after` operator. For example, suppose that you want to define a time delay using the expression `at(5.33, sec)`.



To prevent a run-time error, change the transition label to `after(5.33, sec)`.



Do Not Use after for Absolute-Time Temporal Logic in Charts in Simulink Models

In charts in a Simulink model, using `every` as an absolute-time temporal logic operator is not supported. Instead, use an outer self-loop transition with the `after` operator. For example, suppose that you want to print a status message for an active state every 2.5 seconds during chart execution.

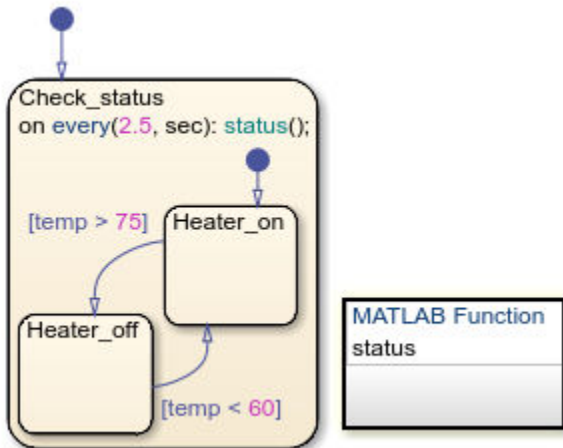

To prevent a run-time error, replace the state action with an outer self-loop transition.

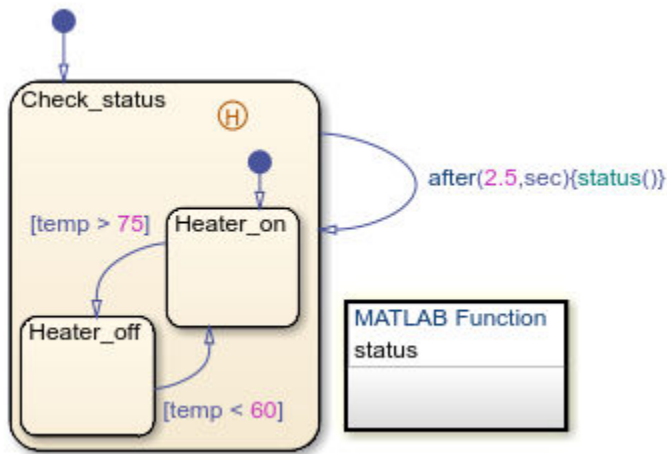

Add a history junction in the state so the chart remembers the state settings prior to each self-loop transition. See “Record State Activity by Using History Junctions” on page 8-2.

Do Not Use Temporal Logic in Transition Paths with Multiple Sources in Standalone Charts in MATLAB

Standalone charts in MATLAB do not support the use of temporal logic operators on transition paths that have more than one source state. For example, this standalone chart produces a run-time error because the temporal logic expression `after(10,sec)` triggers a transition path that has more than one source state.

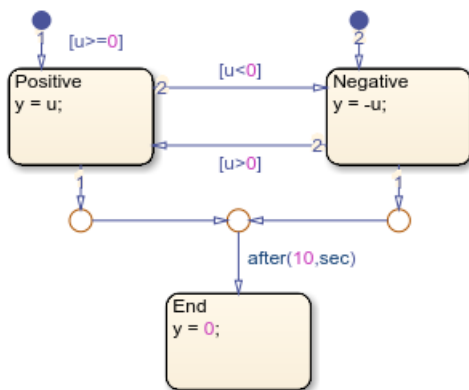

To resolve the issue, use temporal logic expressions on separate transition paths, each with a single source state.

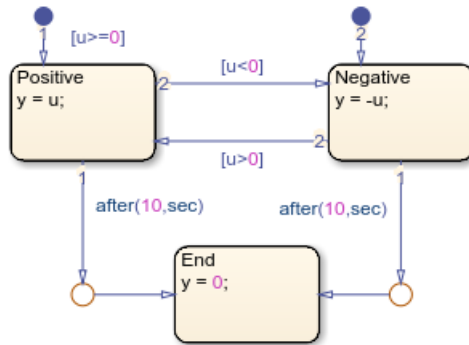

Avoid Mixing Absolute-time Temporal Logic and Conditions in Transition Paths of Standalone Charts in MATLAB

In standalone charts in MATLAB, the operators `after`, `at`, and `every` create MATLAB timer objects that generate implicit events to wake up the chart. Combining these operators with conditions on the same transition path can result in unintended behavior:

- If a condition on the transition path is false when the timer wakes up the chart, the chart performs the during and on actions of the active state.
- The chart does not reset the timer object associated with the operators `after` and `at`. If the condition on the transition path becomes true at a later time, the transition does not take place until another explicit or implicit event wakes up the chart.

For example, in this chart, the transition path from state A to state B combines the absolute-time temporal logic trigger `after(1, sec)` and the condition `[guard]`. The transition from state A to state C has the absolute-time temporal logic trigger `after(5, sec)`. Each transition is associated with a timer object that generates an implicit event. Initially, the local variable `guard` is false.

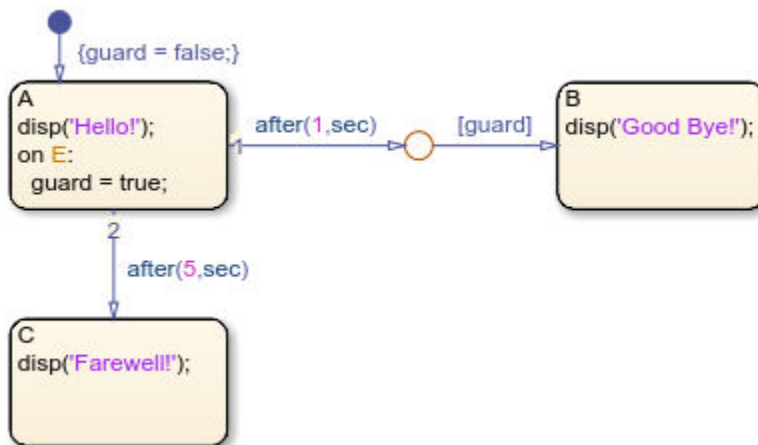

When you execute the chart, state A becomes active. The chart performs the entry action and displays the message 'Hello!'. After 1 second, the timer associated with the transition from A to B wakes up the chart. Because the transition is not valid, the chart executes the during action in state A and displays the message 'Hello!' a second time.

Suppose that, after 2 seconds, the chart receives the input event E. The chart executes the on action in state A and changes the value of `guard` to true. Because the chart does not reset the timer

associated with the operator `after`, the transition from A to B does not take place until another event wakes up the chart.

After 5 seconds, the `timer` associated with the transition from A to C wakes up the chart. Because the transition from A to B is valid and has a higher execution order, the chart does not take the transition to state C or display the message 'Farewell!'. Instead, state B becomes active and the chart displays the message 'Good bye!'.

Use Charts with Discrete Sample Times for More Efficient Code Generation

The code generated for discrete charts that are not inside a triggered or enabled subsystem uses integer counters to track time instead of the time provided by Simulink. This behavior allows for more efficient code generation in terms of overhead and memory, and enables this code for use in software-in-the-loop (SIL) and processor-in-the-loop (PIL) simulation modes. For more information, see “SIL and PIL Simulations” (Embedded Coder).

See Also

Signal Editor | Step | after | at | before | count | duration | elapsed | every | temporalCount | timer

More About

- “Control Oscillations by Using the duration Operator” on page 13-70
- “Implement an Automatic Transmission Gear System by Using the duration Operator”
- “Count Events by Using the temporalCount Operator” on page 11-26
- “Events in Standalone Charts” on page 3-53
- “Record State Activity by Using History Junctions” on page 8-2

Detect Changes in Data Values

Stateflow charts can detect changes in the values of data between time steps. You can use change detection operators to determine when a variable changes to or from a value.

To generate an implicit local event when the chart sets the value of a variable, use the change operator. For more information, see “Control Chart Behavior by Using Implicit Events” on page 11-23.

Change Detection Operators

To detect changes in Stateflow data, use the operators listed in this table.

Operator	Syntax	Description	Example
hasChanged	<code>tf = hasChanged(data_name)</code>	Returns 1 (<code>true</code>) if the value of <code>data_name</code> at the beginning of the current time step is different from the value of <code>data_name</code> at the beginning of the previous time step. Otherwise, the operator returns 0 (<code>false</code>).	<p>Return <code>true</code> if any element of the matrix <code>M</code> has changed value since the last time step or input event.</p> <pre>hasChanged(M)</pre> <p>Return <code>true</code> if the element in row 1 and column 3 of the matrix <code>M</code> has changed value since the last time step or input event.</p> <p>In charts that use MATLAB as the action language, use:</p> <pre>hasChanged(M(1,3))</pre> <p>In charts that use C as the action language, use:</p> <pre>hasChanged(M[0][2])</pre>
hasChangedFrom	<code>tf = hasChangedFrom(data_name,value)</code>	Returns 1 (<code>true</code>) if the value of <code>data_name</code> was equal to the specified <code>value</code> at the beginning of the previous time step and is a different value at the beginning of the current time step. Otherwise, the operator returns 0 (<code>false</code>).	<p>Return <code>true</code> if the previous value of the structure <code>struct</code> was equal to <code>structValue</code> and any field of <code>struct</code> has changed value since the last time step or input event.</p> <pre>hasChangedFrom(struct,structValue)</pre>
hasChangedTo	<code>tf = hasChangedTo(data_name,value)</code>	Returns 1 (<code>true</code>) if the value of <code>data_name</code> was not equal to the specified <code>value</code> at the beginning of the previous time step and is equal to <code>value</code> at the beginning of the current time step. Otherwise, the operator returns 0 (<code>false</code>).	<p>Return <code>true</code> if the structure field <code>struct.field</code> has changed to the value 5 since the last time step or input event.</p> <pre>hasChangedTo(struct.field,5)</pre>

Note If multiple input events occur in the same time step, these operators can detect changes in data value between input events.

Example of Chart with Change Detection

This model shows how the operators `hasChanged`, `hasChangedFrom`, and `hasChangedTo` detect specific changes in an input signal. In this example, a Ramp block sends a discrete, increasing time signal to a chart.

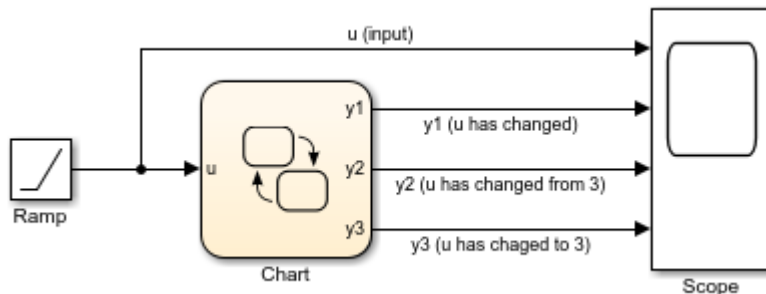

The model uses a fixed-step solver with a step size of 1. The signal increments by 1 every time step. The chart analyzes the input signal `u` for these changes:

- Any change from the previous time step
- A change to the value 3
- A change from the value 3

To check the signal, the chart calls three change detection operators in a transition action. The chart outputs the return values as `y1`, `y2`, and `y3`.

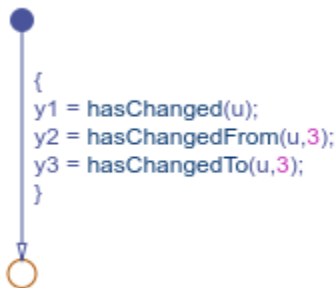

During simulation, the Scope block shows the input and output signals for the chart.

- The value of `u` increases by 1 every time step.
- The value of `y1` changes from 0 to 1 at time $t = 1$. The value of `y1` remains 1 because `u` continues to change at each subsequent time step.
- The value of `y2` changes from 0 to 1 at time $t = 4$ when the value of `u` changes from 3 to 4. The value of `y2` returns to 0 after one time step.
- The value of `y3` changes from 0 to 1 at time $t = 3$ when the value of `u` changes from 2 to 3. The value of `y3` returns to 0 after one time step.

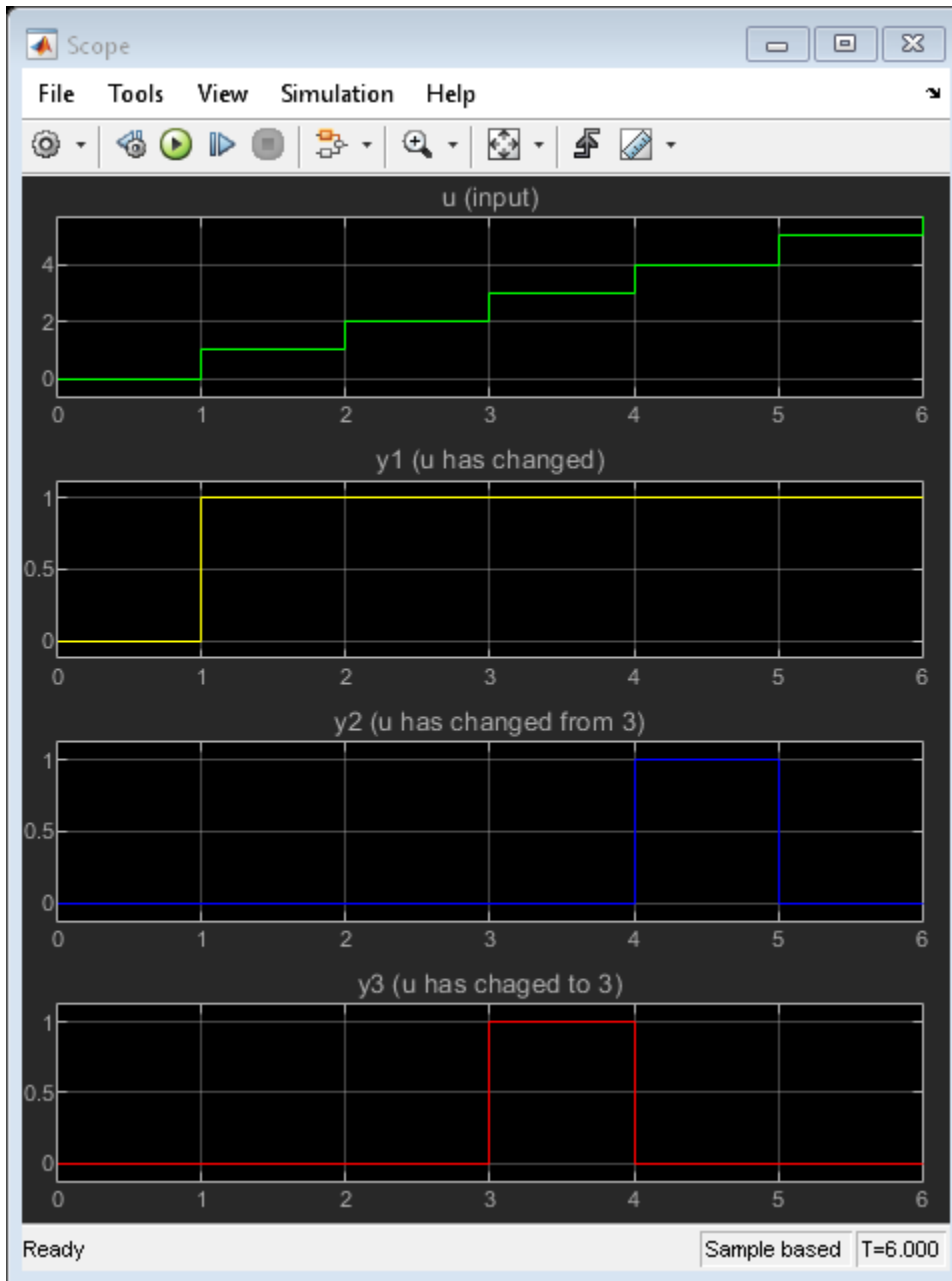

Limitations of Change Detection

The type of Stateflow chart determines the scope of the data supported for change detection:

- Standalone Stateflow charts in MATLAB: Local only
- In Simulink models, charts that use MATLAB as the action language: Input only
- In Simulink models, charts that use C as the action language: Input, Output, Local, or Data Store Memory

The argument `data_name` can be:

- A scalar variable.
- A matrix or an element of a matrix.
 - If `data_name` is a matrix, the operator returns `true` when it detects a change in any element of `data_name`.
 - Index elements of a matrix by using numbers or expressions that evaluate to a constant integer. See “Supported Operations for Vectors and Matrices” on page 18-4.
- A structure or a field in a structure.
 - If `data_name` is a structure, the change detection operator returns `true` when it detects a change in any field of `data_name`.
 - Index fields in a structure by using dot notation. See “Index and Assign Values to Stateflow Structures” on page 26-7.
- Any valid combination of structure fields or matrix elements.

The argument `data_name` cannot be a nontrivial expression or a custom code variable.

Note Standalone charts in MATLAB do not support change detection on an element of a matrix or a field in a structure.

For the `hasChangedFrom` and `hasChangedTo` operators, the argument `value` can be any expression that resolves to a value that is comparable with `data_name`.

- If `data_name` is a scalar, then `value` must resolve to a scalar value.
- If `data_name` is a matrix, then `value` must resolve to a matrix value with the same dimensions as `data_name`.

Alternatively, in a chart that uses C as the action language, `value` can resolve to a scalar value. The chart uses scalar expansion to compare `data_name` to a matrix whose elements are all equal to the value specified by `value`. See “Assign Values to All Elements of a Matrix” on page 18-6.

- If `data_name` is a structure, then `value` must resolve to a structure value whose field specification matches `data_name` exactly.

Implementation of Change Detection

A chart detects changes in chart data by evaluating values at time step boundaries. The chart compares the value at the beginning of the previous execution step with the value at the beginning of the current execution step. To detect changes, the chart double-buffers these values in local variables.

Local Buffer	Description
<code>var_name_prev</code>	Value of data <code>var_name</code> at the beginning of the last time step
<code>var_name_start</code>	Value of data <code>var_name</code> at the beginning of the current time step

Double-buffering occurs once per time step, except when multiple input events occur in the same time step. If multiple input events occur in the same time step, double-buffering occurs once per input event. See “Detect Value Changes Between Input Events” on page 13-62.

For example, when you invoke the `hasChanged` operator, the Stateflow chart:

- Double-buffers data values *after* an event triggers the chart but *before* the chart begins execution.
- Compares values in the x_{prev} and x_{start} buffers. If the values match, the change detection operator returns `false` (to indicate that no change occurred); otherwise, it returns `true` (to indicate a change).

This diagram places these tasks in the context of the chart life cycle.

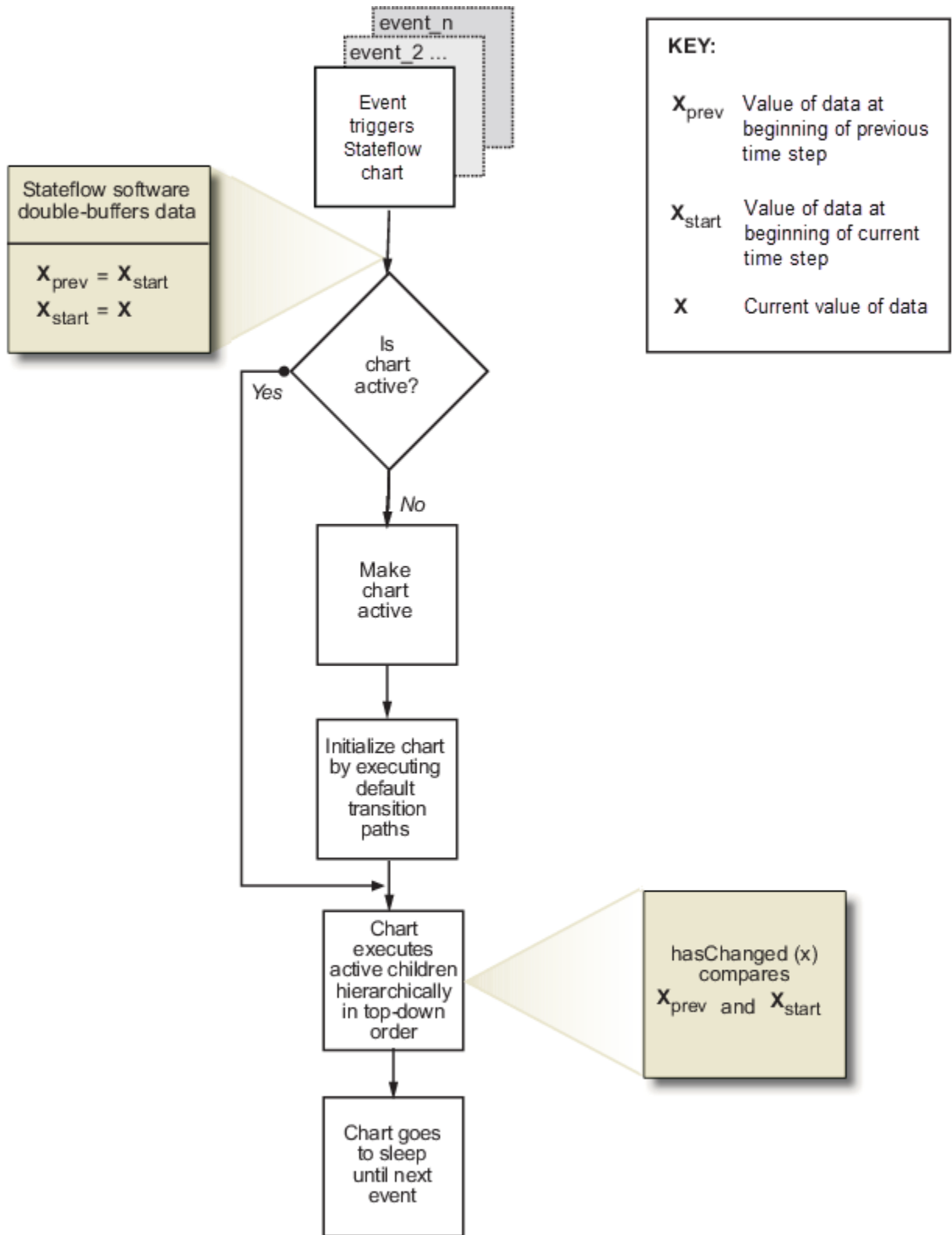

Transient Value Changes in Local Data

The change detection operators attempt to filter out transient changes in local chart variables by evaluating their values only at time boundaries. The chart evaluates the specified local variable only once at the end of the execution step. The return value of the change detection operators remains constant even if the value of the local variable fluctuates within a given time step. For example, suppose that in the current time step, the local variable `temp` changes from its value at the previous time step but then reverts to the original value. The operator `hasChanged(temp)` returns `false` for the next time step, indicating that no change occurred.

Detect Value Changes Between Input Events

When multiple input events occur in the same time step, a chart updates the `xprev` and `xstart` buffers once per event. A chart detects changes between input events, even if the changes occur more than once in a given time step.

See Also

`change` | `hasChanged` | `hasChangedFrom` | `hasChangedTo`

More About

- “Design a Game by Using Stateflow”
- “Control Chart Behavior by Using Implicit Events” on page 11-23

Control Function-Call Subsystems by Using bind Actions

You can bind specified data and events to a state by using `bind` actions. Events bound to a state can be broadcast only by the actions in that state or its children. You can also bind a function-call event to a state to enable or disable the function-call subsystem that the event triggers. The function-call subsystem enables when the state with the bound event is entered and disables when that state is exited. Execution of the function-call subsystem is fully bound to the activity of the state that calls it.

Bind a Function-Call Subsystem to a State

By default, a function-call subsystem is controlled by the chart in which the associated function call output event is defined. This association means that the function-call subsystem is enabled when the chart wakes up and remains active until the chart goes to sleep. To achieve a finer level of control, you can bind a function-call subsystem to a state within the chart hierarchy by using a `bind` action (see “bind Actions” on page 13-4).

You can bind function-call output events to a state. When you create this type of binding, the function-call subsystem that is called by the event is also bound to the state. In this situation, the function-call subsystem is enabled when the state is entered and disabled when the state is exited.

When you bind a function-call subsystem to a state, you can fine-tune the behavior of the subsystem when it is enabled and disabled, as described in the following sections:

- “Handle Outputs When the Subsystem is Disabled” on page 13-63
- “Control Behavior of States When the Subsystem is Enabled” on page 13-64

Handle Outputs When the Subsystem is Disabled

Although function-call subsystems do not execute while disabled, their output signals are available to other blocks in the model. If a function-call subsystem is bound to a state, you can hold its outputs at their values from the previous time step or reset the outputs to their initial values when the subsystem is disabled. Follow these steps:

- 1 Double-click the output block of the subsystem to open the Block Parameters dialog box.

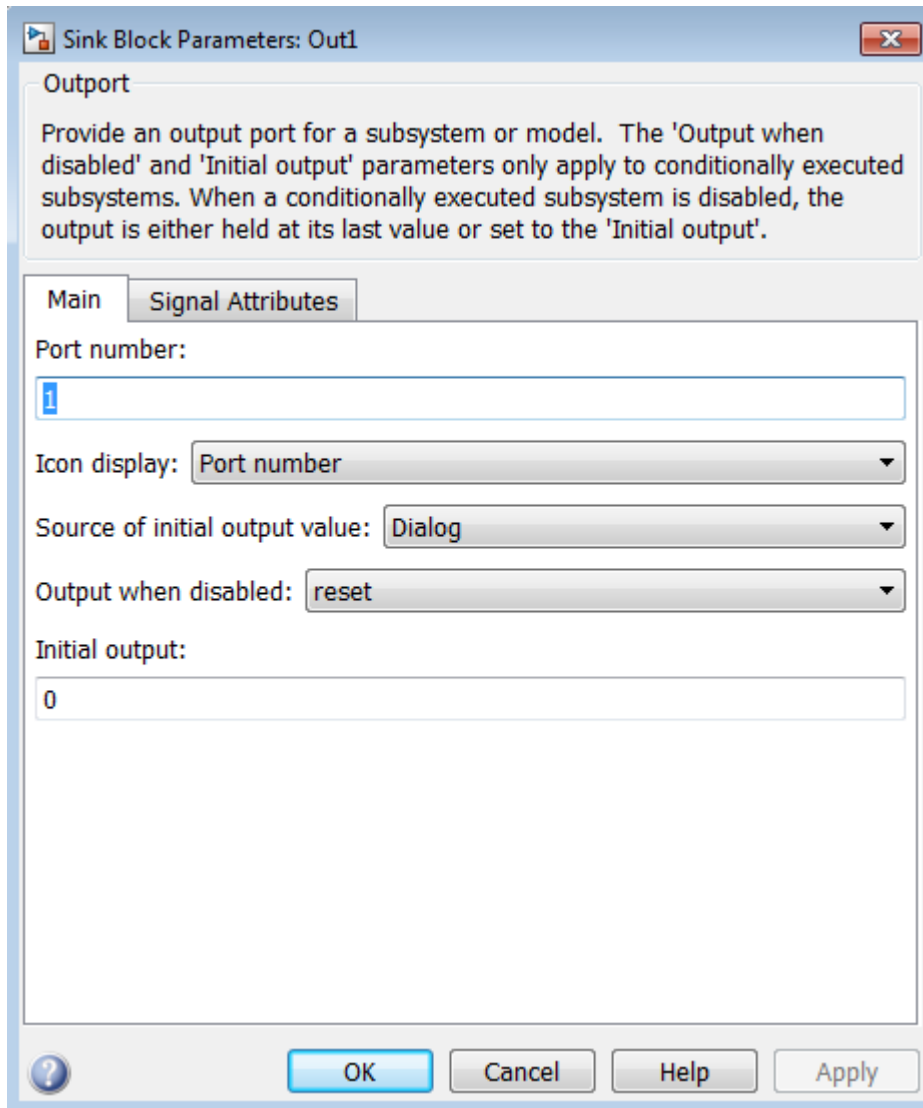

- 2 Select an option for **Output when disabled**:

Select:	To:
held	Maintain most recent output value
reset	Reset output to its initial value

- 3 Click **OK** to record the settings.

Note Setting **Output when disabled** is meaningful only when the function-call subsystem is bound to a state, as described in “Bind a Function-Call Subsystem to a State” on page 13-63.

Control Behavior of States When the Subsystem is Enabled

If a function-call subsystem is bound to a state, you can hold the subsystem state variables at their values from the previous time step or reset the state variables to their initial conditions when the

subsystem executes. In this way, the binding state gains full control of state variables for the function-call subsystem. Follow these steps:

- 1 Double-click the trigger port of the subsystem to open the Block Parameters dialog box.

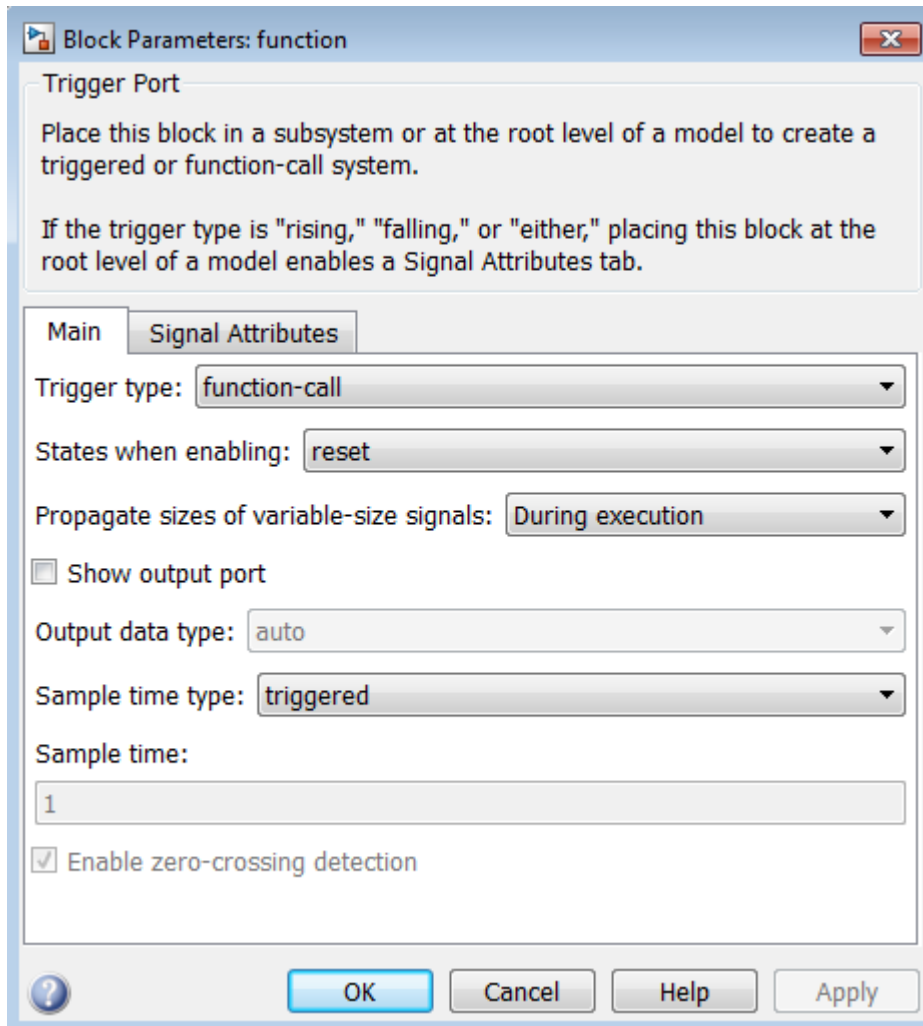

- 2 Select an option for **States when enabling**:

Select:	To:
held	Maintain most recent values of the states of the subsystem that contains the trigger port
reset	Revert to the initial conditions of the states of the subsystem that contains this trigger port
inherit	Inherit this setting from the function-call initiator's parent subsystem. If the parent of the initiator is the model root, the inherited setting is held. If the trigger has multiple initiators, the parents of all initiators must have the same setting: either all held or all reset.

- 3 Click **OK** to record the settings.

Note Setting **States when enabling** is meaningful only when the function-call subsystem is bound to a state, as described in “Bind a Function-Call Subsystem to a State” on page 13-63.

Bind a Function-Call Subsystem to a State

This model triggers a function-call subsystem with a trigger event E that binds to a state of a chart. In the **Solver** pane of the Model Configuration Parameters dialog box, the model specifies a fixed-step solver with a fixed-step size of 1.

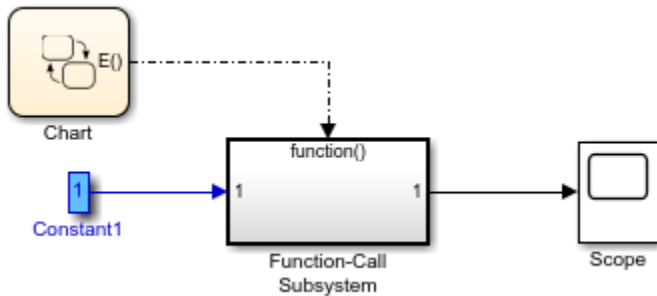

The chart contains two states. Event E binds to state A with the action

```
bind:E
```

Event E is defined for the chart with a scope of `Output` to Simulink and a trigger type of `function-call`.

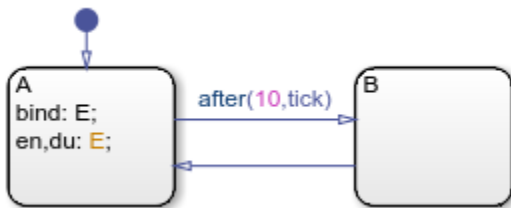

The function-call subsystem contains a trigger port block, an input port, an output port, and a simple block diagram. The block diagram increments a counter by 1 at each time step, using a Unit Delay block.

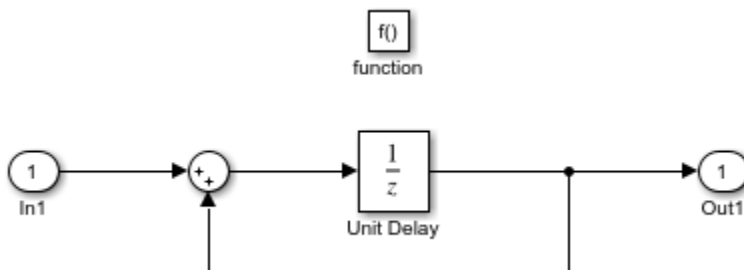

The Block Parameters dialog box for the trigger port contains these settings:

- **Trigger type:** function-call.
- **States when enabling:** reset. This setting resets the state values for the function-call subsystem to zero when it is enabled.
- **Sample time type:** triggered. This setting sets the function-call subsystem to execute only when it is triggered by a calling event while it is enabled.

Setting **Sample time type** to **periodic** enables the **Sample time** field below it, which defaults to 1. These settings force the function-call subsystem to execute for each time step specified in the **Sample time** field while it is enabled. To accomplish this, the state that binds the calling event for the function-call subsystem must send an event for the time step coinciding with the specified sampling rate in the **Sample time** field. States can send events with entry or during actions at the simulation sample rate.

- For fixed-step sampling, the **Sample time** value must be an integer multiple of the fixed-step size.
- For variable-step sampling, the **Sample time** value has no limitations.

To see how a state controls a bound function-call subsystem, begin simulating the model.

- At time $t = 0$, the default transition to state A occurs. State A executes its bind and entry actions. The binding action binds event E to state A, enabling the function-call subsystem and resetting its state variables to 0. The entry action triggers the function-call subsystem and executes its block diagram. The block diagram increments a counter by 1 using a Unit Delay block. The Unit Delay block outputs a value of 0 and holds the new value of 1 until the next call to the subsystem.
- At time $t = 1$, the next update event from the model tests state A for an outgoing transition. The transition to state B does not occur because the temporal operator `after(10, tick)` allows the transition to be taken only after ten update events are received. State A remains active and its during action triggers the function-call subsystem. The Unit Delay block outputs its held value of 1. The subsystem also increments its counter to produce the value of 2, which the Unit Delay block holds until the next triggered execution.
- The next eight update events increment the subsystem output by one at each time step.
- At time $t = 10$, the transition from state A to state B occurs. Because the binding to state A is no longer active, the function-call subsystem is disabled, and its output drops back to 0.
- At time $t = 11$, the transition from state B to state A occurs. Again, the binding action enables the function-call subsystem. Subsequent update events increment the subsystem output by one at each time step until the next transition to state B occurs at time $t = 21$.

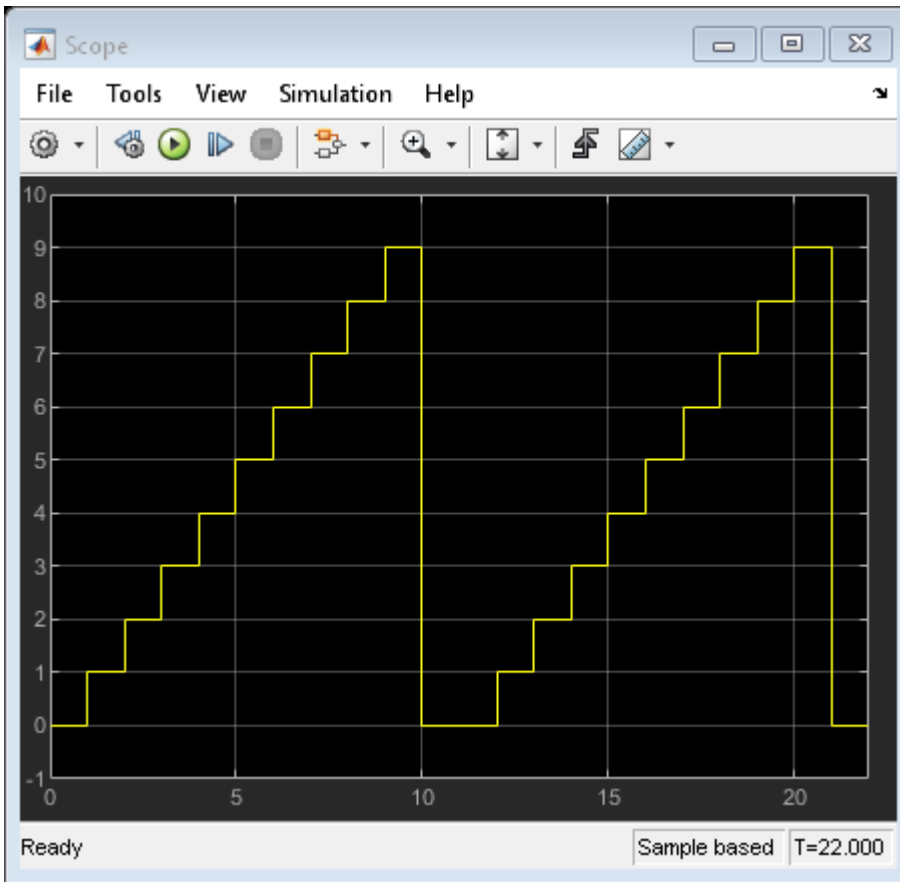

Avoid Muxed Trigger Events with Binding

Binding events gives control of a function-call subsystem to a single state in a chart. This control does not work when you allow other events to trigger the function-call subsystem through a mux. For example, this model defines two function-call events to trigger a function-call subsystem using a Mux block.

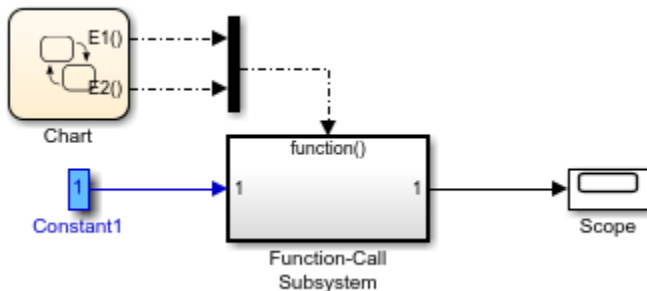

In the chart, E1 binds to state A, but E2 does not. State B sends the triggering event E2 in its entry action.

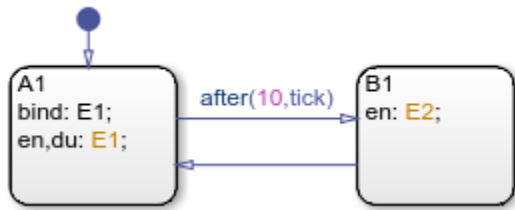

When you simulate this model, the output does not reset when the transition from state A to state B occurs.

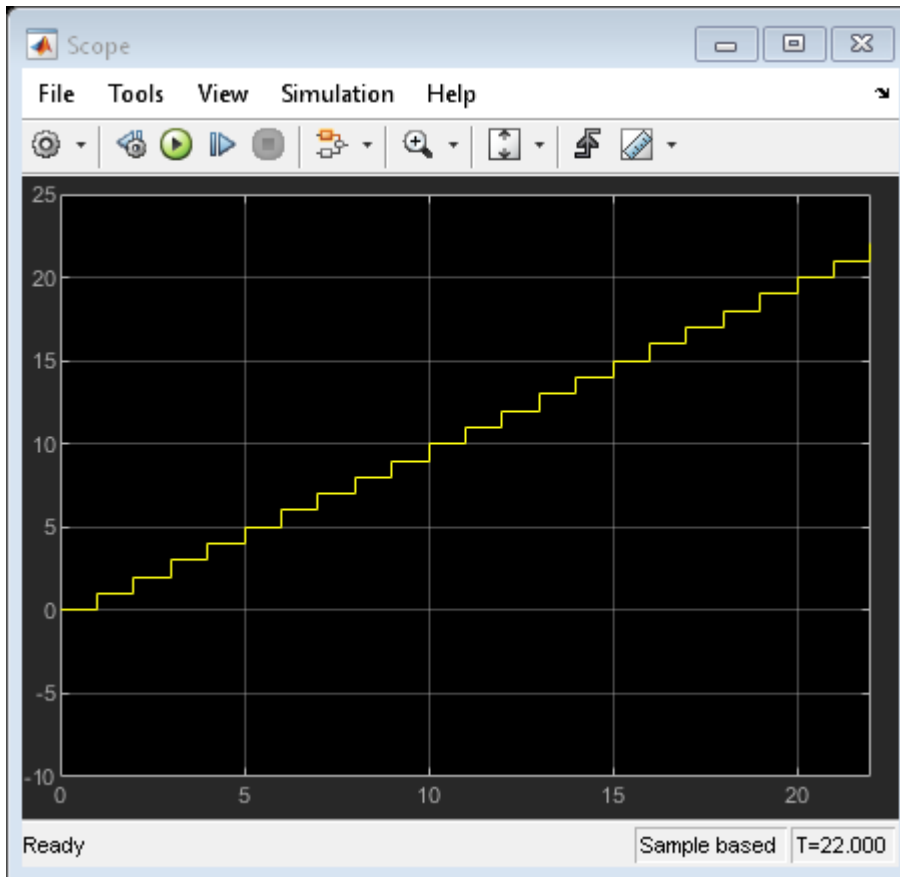

Binding is not recommended when you provide multiple trigger events to a function-call subsystem through a mux. Muxed trigger events can interfere with event binding and cause undefined behavior.

Control Oscillations by Using the duration Operator

The following example focuses on the gear logic of a car as it shifts from first gear to fourth gear.

When modeling the gear changes of this system, it is important to control the oscillation that occur. The model `sf_car` uses parallel state debouncer logic that controls which gear state is active. For more information about how debouncers work in Stateflow, see “Reduce Transient Signals by Using Debouncing Logic” on page 27-2.

You can simplify the debouncer logic by using the `duration` operator. You can see this simplification in the model `sf_car_using_duration`. The `duration` operator evaluates a condition expression and outputs the length of time that the expression has been `true`. When that length of time crosses a known time threshold, the state transitions to a higher or lower gear.

By removing the parallel state logic and using the `duration` operator, you can control oscillations with simpler Stateflow logic. The `duration` operator is supported only in Stateflow charts in a Simulink model.

Control Oscillation with Parallel State Logic

Open the model `sf_car`. While `shift_logic` is highlighted, in the **State Chart** tab, click **Look Under Mask**.

The Stateflow chart `shift_logic` controls which gear the car is in, given the speed of the car and how much throttle is being applied. Within `shift_logic` there are two parallel states: `gear_state` and `selection_state`. `gear_state` contains four exclusive states for each gear. `selection_state` determines whether the car is downshifting, upshifting, or remaining in its current gear.

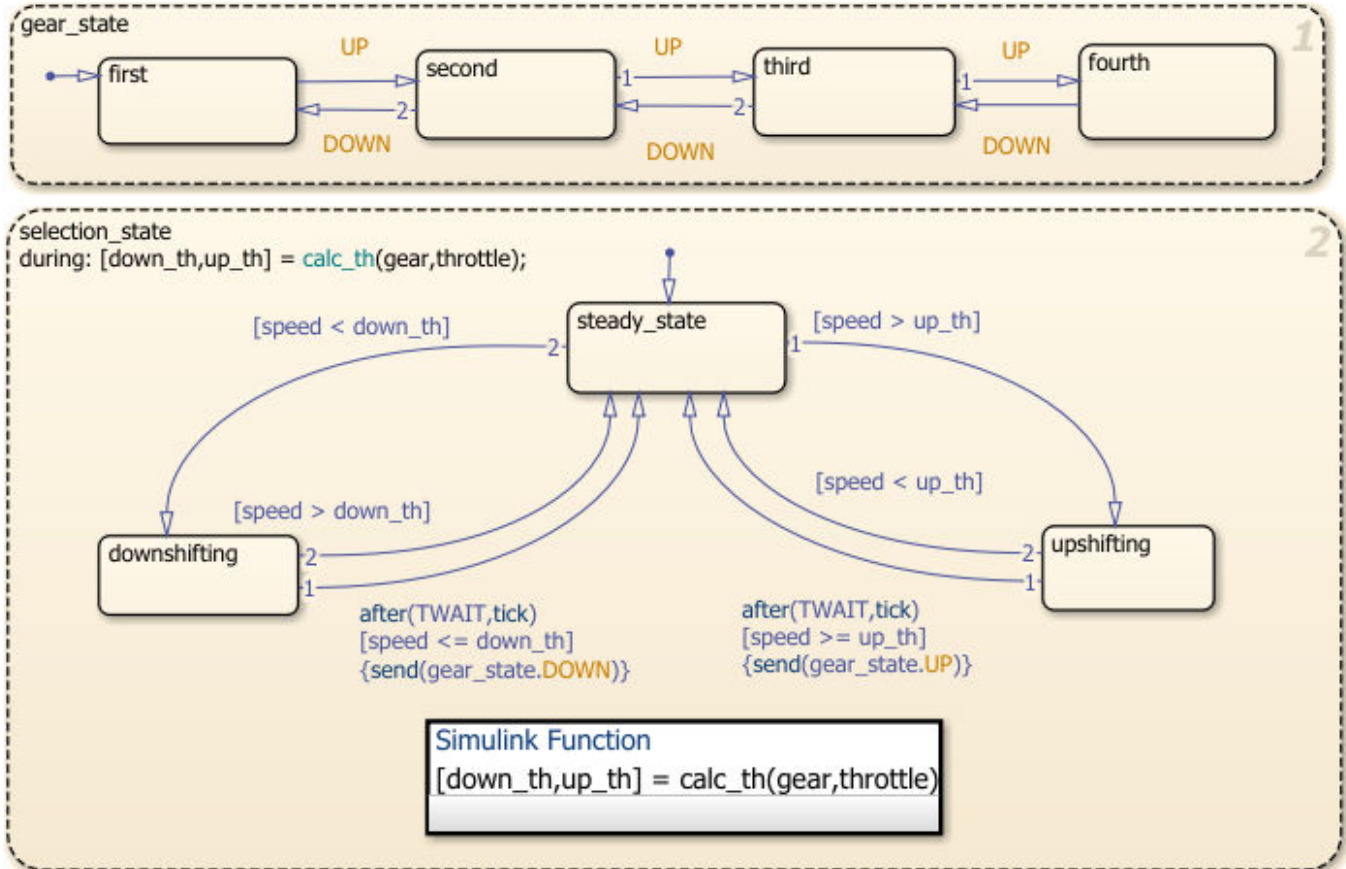

In this Stateflow chart, for the car to move from first gear to second gear, the event UP must be sent from selection_state to gear_state. The event is sent when the speed crosses the threshold and remains higher than the threshold for the length of time determined by TWAIT. When the event UP is sent, gear_state transitions from first to second.

Control Oscillation with the duration Operator

Open the model sf_car_using_duration. While Gear_Logic is highlighted, in the **State Chart** tab, click **Look Under Mask**.

Within Gear_Logic there are four exclusive states for each gear. The local variables up and down guard the transitions between each state.

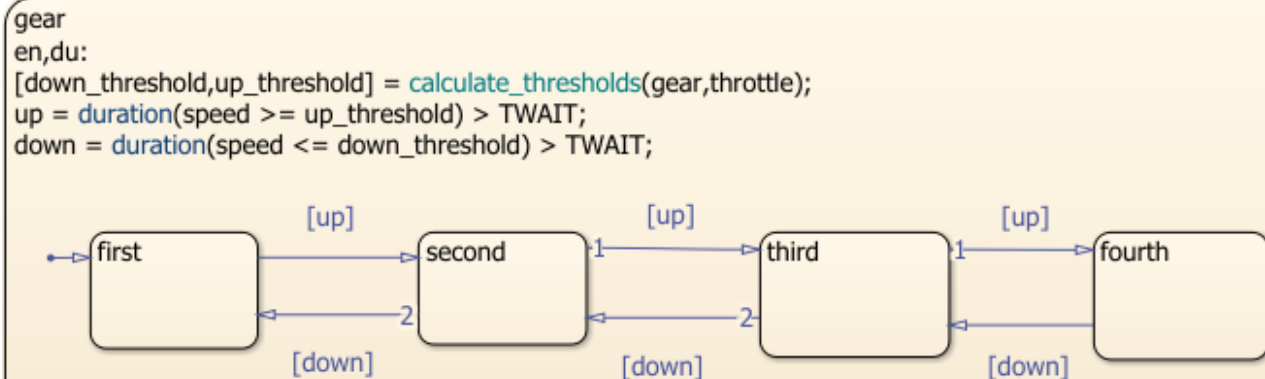

```

Simulink Function
[down_th,up_th] = calculate_thresholds(gear,throttle)

```

In this Stateflow chart, for the car to move from first gear to second gear, the condition `up` must be true. The condition `up` is defined as true if the length of time that the speed is greater than or equal to the threshold is greater than the length of time that is specified by `TWAIT`. The condition `down` is defined as true if the length of time that the speed is less than or equal to the threshold is greater than the length of time that is specified by `TWAIT`. The operator `duration` keeps track of the length of time that the speed has been above or below the threshold. When the `up` condition is met, the active state transitions from `first` to `second`.

By replacing the parallel state debouncer logic with the `duration` operator, you can create a simpler Stateflow chart to model the gear shifting.

See Also

`duration`

Related Examples



- “Reduce Transient Signals by Using Debouncing Logic” on page 27-2
- “Control Chart Execution by Using Temporal Logic” on page 13-40

MATLAB Syntax Support for States and Transitions

- “Modify the Action Language for a Chart” on page 14-2
- “Differences Between MATLAB and C as Action Language Syntax” on page 14-5
- “Model an Assembly Line Feeder” on page 14-9

Modify the Action Language for a Chart

Stateflow charts in Simulink models have an action language property that defines the syntax for state and transition actions. An icon in the lower-left corner of the chart canvas indicates the action language for the chart.

-  MATLAB as the action language.
-  C as the action language.

You can change the action language of a chart in the **Action Language** box of the Chart properties dialog box. For more information, see “Differences Between MATLAB and C as Action Language Syntax” on page 14-5.

Change the Default Action Language

MATLAB is the default action language syntax for new Stateflow charts. To create a chart that uses C as the action language, enter:

```
sfnew -c
```

To change the default action language of new charts, use these commands.

Command	Result
<code>sfpref('ActionLanguage','MATLAB')</code>	All new charts created have MATLAB as the action language, unless otherwise specified in <code>sfnew</code> .
<code>sfpref('ActionLanguage','C')</code>	All new charts created have C as the action language, unless otherwise specified in <code>sfnew</code> .

For more information, see `sfnew`.

Auto Correction When Using MATLAB as the Action Language

Stateflow charts that use MATLAB as the action language automatically correct common C constructs to MATLAB syntax:

- Increment and decrement operations such as `a++` and `a--`. For example, `a++` is changed to `a = a + 1`.
- Assignment operations such as `a += b`, `a -= b`, `a *= b`, and `a /= b`. For example, `a += b` is changed to `a = a + b`.
- Evaluation operations such as `a != b` and `!a`. For example, `a != b` is changed to `a ~= b`.
- Comment markers `//` and `/* */` are changed to `%`.

C to MATLAB Syntax Conversion

For nonempty charts, after you change the action language property from C to MATLAB, a notification appears at the top of the chart. The notification provides the option to convert some of

the C syntax to MATLAB syntax. In the notification, click the link to have Stateflow convert syntax in the chart. C syntax constructs that are converted include:

- Zero-based indexing.
- Increment and decrement operations such as `a++` and `a--`. For example, `a++` is changed to `a = a + 1`.
- Assignment operations such as `a += b`, `a -= b`, `a *= b`, and `a /= b`. For example, `a += b` is changed to `a = a + b`.
- Binary operations such as `a %% b`, `a >> b`, and `a << b`. For example, `a %% b` is changed to `rem(a, b)`.
- Bitwise operations such as `a ^ b`, `a & b`, and `a | b`. For example, if the chart property **Enable C-bit operations** is selected, then `a ^ b` is changed to `bitxor(a, b)`.
- C style comment markers. For example, `//` and `/* */` are changed to `%`.

If the chart contains C constructs that cannot be converted to MATLAB, Stateflow shows a message in a dialog box. Click on the warnings link to display the warnings in the Diagnostic Viewer. Choose whether or not to continue with the conversion of supported syntax. C constructs not converted to MATLAB include:

- Explicit type casts with `cast` and `type`
- Operators such as `&`, `*` and `:=`
- Custom data
- Access to workspace variables using `ml` operator
- Functions not supported in code generation
- Hexadecimal and single precision notation
- Context-sensitive constants

Rules for Using MATLAB as the Action Language

Use unique names for data in a chart

Using the same name for data at different levels of the chart hierarchy causes a compile-time error.

Use unique names for functions in a chart

Using the same name for functions at different levels of the chart hierarchy causes a compile-time error.

Include a type prefix for identifiers of enumerated values

The identifier `TrafficColors.Red` is valid, but `Red` is not.

Use the MATLAB format for comments

Use `%` to specify comments in states and transitions for consistency with MATLAB. For example, the following comment is valid:

```
% This is a valid comment in the style of MATLAB
```

C style comments, such as `//` and `/* */`, are auto-corrected to use `%`.

Use one-based indexing for vectors and matrices

One-based indexing is consistent with MATLAB syntax.

Use parentheses instead of brackets to index into vectors and matrices

This statement is valid:

```
a(2,5) = 0;
```

This statement is not valid:

```
a[2][5] = 0;
```

Do not use control flow logic in condition actions and transition actions

If you try to use control flow logic in condition actions or transition actions, you get an error. Use of an `if`, `switch`, `for`, or `while` statement does not work.

Do not use transition actions in graphical functions

Transition labels in graphical functions do not support transition actions.

Enclose transition actions with braces

The following transition label contains a valid transition action:

```
E [x > 0] / {x = x+1;}
```

The following transition label:

```
E [x > 0] / x = x+1;
```

is incorrect, but is auto-corrected to the valid syntax.

Do not declare global or persistent variables in state actions

The keywords `global` and `persistent` are not supported in state actions.

To generate code from your model, use MATLAB language features supported for code generation



Otherwise, use `coder.extrinsic` to call unsupported functions, which gives the functionality that you want for simulation, but not in the generated code. For a list of supported features and functions, see “Language, Function, and Object Support” (Simulink).

Assign an initial value to local and output data

When using MATLAB as the action language, data read without an initial value causes an error.

Differences Between MATLAB and C as Action Language Syntax

Stateflow charts in Simulink models have an action language property that defines the syntax for state and transition actions. An icon in the lower-left corner of the chart canvas indicates the action language for the chart.

-  MATLAB as the action language.
-  C as the action language.

MATLAB is the default action language syntax for new Stateflow charts. To create a chart that uses C as the action language, enter:

```
sfnew -c
```

Compare Functionality of Action Languages

This table lists the most significant differences in functionality between the two action languages.

Functionality	MATLAB as the Action Language	C as the Action Language
Vector and matrix indexing	One-based indexing delimited by parentheses and commas. For example, <code>A(4,5)</code> . See “Supported Operations for Vectors and Matrices” on page 18-4.	Zero-based indexing delimited by square brackets. For example, <code>A[3][4]</code> . See “Supported Operations for Vectors and Matrices” on page 18-4.
C constructs: <ul style="list-style-type: none"> • Increment and decrement operations <code>a++</code> and <code>a--</code> • Assignment operations <code>a += b</code>, <code>a -= b</code>, <code>a *= b</code>, and <code>a /= b</code> • Evaluation operations <code>a != b</code> and <code>!a</code> • Binary operations <code>a %% b</code>, <code>a >> b</code>, <code>a << b</code>, <code>a & b</code>, and <code>a b</code> • Comment markers <code>//</code> and <code>/* */</code> 	Auto-correction to MATLAB syntax. For example, <code>a++</code> is corrected to <code>a = a+1</code> . See “Auto Correction When Using MATLAB as the Action Language” on page 14-2.	Supported. See “Supported Operations for Chart Data” on page 13-13.
Conditional and loop control statements in state actions	Supported. For example, you can use <code>if</code> , <code>for</code> , and <code>while</code> statements in state actions. See “Loops and Conditional Statements” (MATLAB).	Not supported. For conditional and loop patterns, use graphical functions instead. See “Reuse Logic Patterns by Defining Graphical Functions” on page 8-13.

Functionality	MATLAB as the Action Language	C as the Action Language
Format of transition actions	Auto-correction encloses transition actions with braces <code>{}</code> . See “Transition Actions” on page 13-9.	Not required to enclose transition actions with braces <code>{}</code> . See “Transition Actions” on page 13-9.
Ordering of parallel states	Explicit ordering only. See “Execution Order for Parallel States” on page 3-58.	Explicit or implicit ordering. See “Execution Order for Parallel States” on page 3-58.
Integer data types	Signed and unsigned integers with 32, 16, or 8 bits.	Signed and unsigned integers with 64, 32, 16, or 8 bits. 64-bit integers are implemented as fixed-point numbers: <ul style="list-style-type: none"> • <code>int64</code> is an alias type for <code>fixdt(1,64,0)</code>. • <code>uint64</code> is an alias type for <code>fixdt(0,64,0)</code>.
Fixed-point constructs: <ul style="list-style-type: none"> • Special assignment operator <code>:=</code> • Context-sensitive constants such as <code>4.3C</code> 	Not supported.	Supported. See “Override Fixed-Point Promotion in C Charts” on page 23-15 and “Fixed-Point Context-Sensitive Constants” on page 23-4.
Complex data	Use complex number notation <code>a + bi</code> or the <code>complex</code> operator. See “Supported Operations for Complex Data” on page 24-4.	Use the <code>complex</code> operator. Complex number notation is not supported. See “Supported Operations for Complex Data” on page 24-4.
Data type propagation	Follows MATLAB typing rules. For example, adding data of type <code>double</code> to data of type <code>int32</code> results in data of type <code>int32</code> .	Follows C typing rules. For example, adding data of type <code>double</code> to data of type <code>int32</code> results in data of type <code>double</code> .

Functionality	MATLAB as the Action Language	C as the Action Language
Explicit type cast operations	Use one of these casting forms: <ul style="list-style-type: none"> • MATLAB type conversion function. For example, <code>single(x)</code>. • <code>cast</code> function with a type keyword. For example, <code>cast(x, 'int8')</code>. • <code>cast</code> function with the 'like' keyword. For example, <code>cast(x, 'like', z)</code>. The type operator is not supported. See “Type Cast Operations” on page 13-16.	Use one of these casting forms: <ul style="list-style-type: none"> • MATLAB type conversion function. For example, <code>uint16(x)</code>. • <code>cast</code> function with the type operator. For example, <code>cast(x, type(z))</code>. Type keywords for the <code>cast</code> function are not supported. See “Type Cast Operations” on page 13-16.
Scalar expansion	Not supported.	Supported. See “Assign Values to All Elements of a Matrix” on page 18-6.
String data	Not supported.	Supported. See “Manage Textual Information by Using Strings” on page 21-2.
Specification of data properties: <ul style="list-style-type: none"> • First index • Save final value to base workspace • Units 	Not supported.	Supported. For more information, see: <ul style="list-style-type: none"> • “First Index” on page 9-8 • “Save Final Value to Base Workspace” on page 9-16 • “Units” on page 9-16
Scope of data in graphical, truth table, and MATLAB functions	Constant, Parameter, Input, Output	Local, Constant, Parameter, Input, Output, Temporary
Dot notation for specifying states, local data, message, and local events inside MATLAB functions	Supported. See “Identify Data by Using Dot Notation” on page 9-39.	Not supported.

Functionality	MATLAB as the Action Language	C as the Action Language
Custom code functions and variables	Behavior depends on the Import Custom Code configuration parameter. <ul style="list-style-type: none"> • When Import Custom Code is on, both custom code functions and variables are supported in states and transitions (default). • When Import Custom Code is off, only custom code functions are supported. Use the <code>coder.ceval</code> function. See “Custom Code” and “Import custom code” (Simulink).	Custom code functions and variables are supported in states and transitions.
Row-major array layout in generated code	Not supported.	Supported. See “Row-Major Array Layout” on page 32-6.
Multidimensional array layout in generated code	Not supported.	Supported for local data. See “Multidimensional Array Layout” on page 32-6.
Structure parameters	Tunable and nontunable parameters are supported.	Only tunable parameters are supported.
Use of global <code>fimath</code> object	Supported.	Not supported.

See Also

`sfnew`

More About

- “Modify the Action Language for a Chart” on page 14-2
- “Supported Operations for Chart Data” on page 13-13
- “Supported Operations for Vectors and Matrices” on page 18-4
- “Supported Operations for Complex Data” on page 24-4
- “Supported Operations for Fixed-Point Data” on page 23-12
- “Execution Order for Parallel States” on page 3-58

Model an Assembly Line Feeder

Typical Approaches to Chart Programming

There are two general approaches to programming a Stateflow chart in a Simulink model:

- Identify the operating modes of your system.
- Identify the system interface, such as events to which your system reacts.

This tutorial uses the first approach— that is, start by identifying the operating modes of the system to program the chart.

Design Requirements

This example shows how to build a Stateflow chart using MATLAB as the action language. The model represents a machine on an assembly line that feeds raw material to other parts of the line. This feeder behaves as follows:

- At system initialization, check that the three sensor values are normal.

A positive value means the sensor is working correctly. A zero means that the sensor is not working.
- If all sensor values are normal, transition from "system initialization" to "on".
- If the feeder does not leave initialization mode after 5 seconds, force the feeder into the failure state.
- After the system turns on, it starts counting the number of parts fed.
- At each time step, if any sensor reading is 2 or greater, the part has moved to the next station.
- If the alarm signal sounds, force the system into the failure state.

An alarm signal can occur when an operator opens one of the safety doors on the feeder or a downstream problem occurs on the assembly line, which causes all upstream feeders to stop.

- If the all-clear signal sounds, resume normal operation and reset the number of parts fed to zero.
- The feeder LED changes color to match the system operating mode— orange for "system initialization", green for "on", and red for "failure state".

Identify System Attributes

Based on the description of feeder behavior, you can identify the key system attributes.

Attribute	Characteristic
Operating modes	<ul style="list-style-type: none"> • System initialization, to perform system checks before turning on the machine • On, for normal operation • System failure, for a recoverable machine failure flagged by an alarm

Attribute	Characteristic
Transitions	<ul style="list-style-type: none"> • System initialization to On • System initialization to Failure state • On to Failure state • Failure state to System initialization
Parallel Modes	No operating modes run in parallel. Only one mode can be active at any time.
Default Mode	System initialization
Inputs	<ul style="list-style-type: none"> • Three sensor readings to detect if a part has moved to a downstream assembly station • An alarm signal that can take one of two values: 1 for on and 0 for off
Outputs	<ul style="list-style-type: none"> • Number of parts that have been detected as fed to a downstream assembly station • Color of the LED on the feeder

Build the Model Yourself or Use the Supplied Model

In this exercise, you add a Stateflow chart to a Simulink model that contains sensor and alarm input signals to the feeder.

To implement the model yourself, follow these exercises. Otherwise, you can open the completed model.

Add a Stateflow Chart to the Feeder Model

- 1 Open the partially built model.

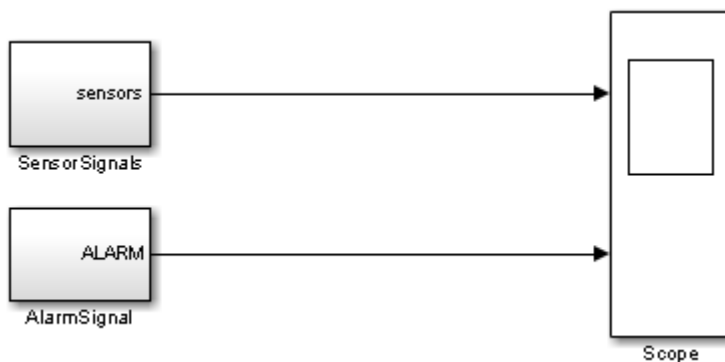

- 2 Double-click the `SensorSignals` block to see the three sensor signals represented by pulse generator blocks.

The `sensors` signal indicates when the assembly part is ready to move to the next station.

- 3 Double-click the `AlarmSignal` block to see the step blocks that represent the alarm signal.

When the `ALARM` signal is active, the machine turns off.

- 4 Run the model to see the output of the sensor and alarm signals in the Scope block.

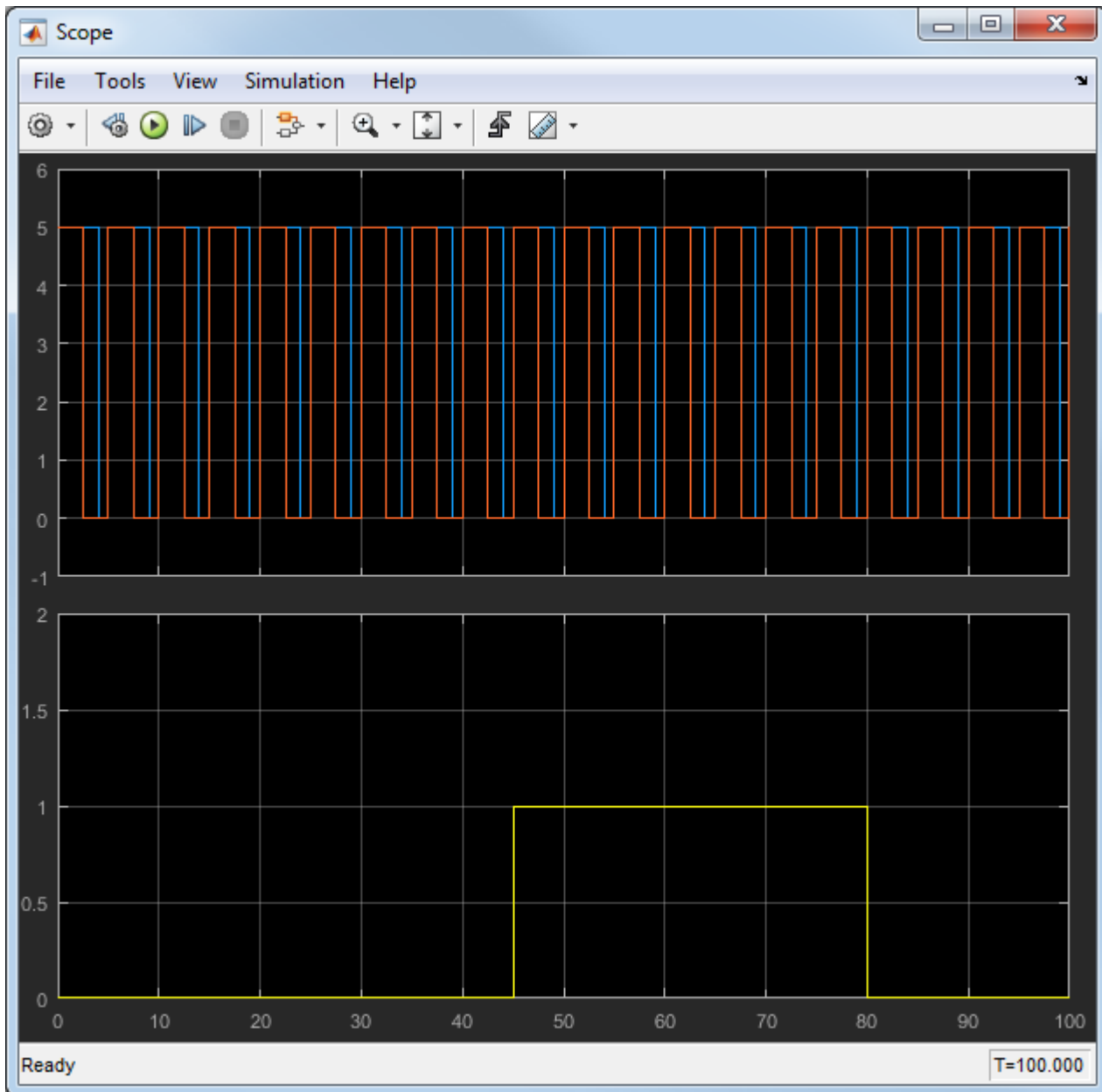

The upper axis shows the sensor signals. Only two sensor signals appear because two of the sensors have the same signal. The lower axis shows the alarm signal which turns the feeder off between the simulation time of 45 to 80 seconds.

- 5 Open the Stateflow Library by executing `sflib` at the MATLAB command prompt.
- 6 Select Chart and drag it into your model.

Tip To create a new model with an empty Stateflow chart which uses MATLAB as the action language, use the command, `sfnw`.

- 7 Delete the connections from the SensorSignals subsystem to the scope and from the AlarmSignal subsystem to the scope.
- 8 Rename the label Chart located under the Stateflow chart to Feeder. The model should now look like this:

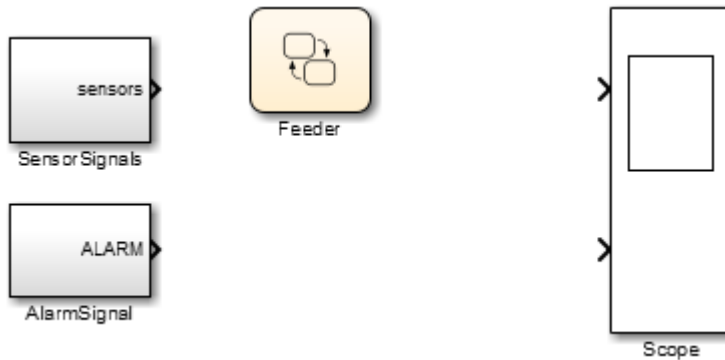

Add States to Represent Operating Modes

Based on the system attributes previously described, there are three operating modes:

- System initialization
- On
- Failure state

To add states for modeling the behavior of these operating modes:

- 1 Double-click the Feeder Chart to begin adding states.

Note The MATLAB icon in the lower left corner of the chart indicates that you are using a Stateflow chart with MATLAB syntax.



- 2 Click the State Tool icon to bring a state into the chart.



- 3 Click the upper left corner of the state and type the name, `InitializeSystem`.
- 4 Repeat steps 2 and 3 to add two more states named `On` and `FailState`.

Implement State Actions

Decide the Type of State Action

States perform actions at different phases of their execution cycle from the time they become active to the time they become inactive. Three basic state actions are:

Type of Action	When Executed	How Often Executed While State Is Active
Entry	When the state is entered (becomes active)	Once
During	While the state is active and no valid transition to another state is available	At every time step
Exit	Before a transition is taken to another state	Once

For example, you can use entry actions to initialize data, during actions to update data, and exit actions to configure data for the next transition. For more information about other types of state actions, see “Syntax for States and Transitions”.)

- 1 Press return after the `InitializeSystem` state name and add this text to define the state entry action:

```
entry:
Light = ORANGE;
```

An orange LED indicates entry into the `InitializeSystem` state.

Syntax for an entry action

The syntax for entry actions is:

```
entry: one or more actions;
```

- 2 Add the following code after the `FailState` state name to define the entry action:

```
entry:
Light = RED;
```

A red LED indicates entry in the `FailState`.

- 3 Add the following code after the `On` state name to define the entry action:

```
entry:
Light = GREEN;
partsFed = 0;
```

A green LED indicates entry in the `On` state. The number of parts fed is initialized to 0 each time we enter the `On` state

- 4 Add the following code to the `On` state after the entry action to check if there is a strong sensor signal and increment the parts fed to the next station:

```
during:
if(any(sensors >= 2))
    partsFed = partsFed + 1;
end
```

The `On` state checks the sensor signal to determine if a part is ready to be fed to the next assembly station. If the sensor signal is strong (the number of sensors that are on is greater than or equal to 2), then the chart counts the part as having moved on to the next station.

Syntax for during actions

The syntax for during actions is:

during: *one or more actions*;

The chart should now look like this figure.

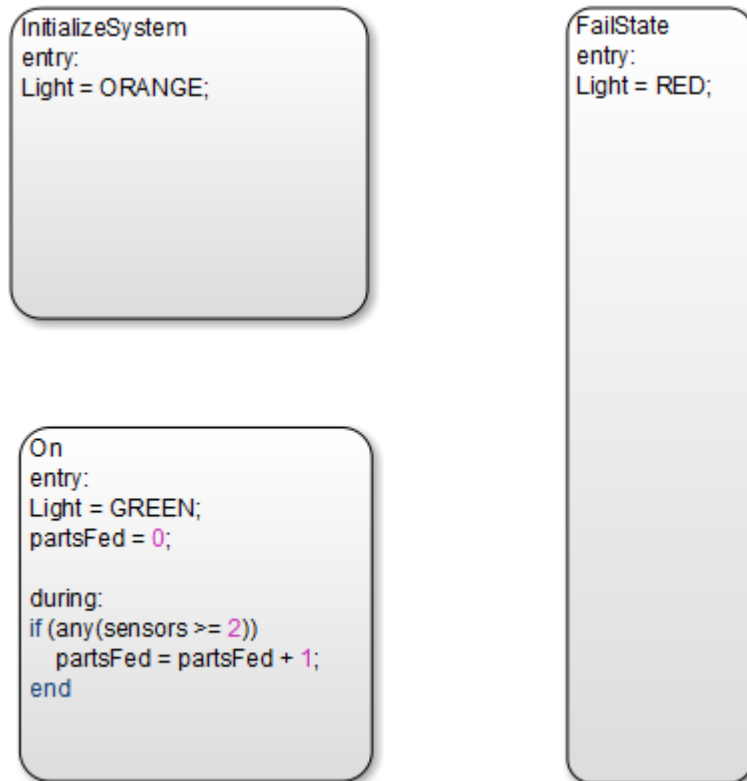

Specify Transition Conditions

Transition conditions specify when to move from one operating mode to another. When the condition is true, the chart takes the transition to the next state, otherwise, the current state remains active. For more information, see “Transitions” on page 2-18.

Based on the description of feeder behavior, specify the rules for transitions between states:

- 1 Connect a default transition to the `InitializeSystem` state to indicate the chart entry point.



“Default Transitions” on page 2-28 specify where to begin the simulation.

- 2 Draw a transition from the `InitializeSystem` state to the `On` state:
 - a Move the mouse over the lower edge of the `InitializeSystem` state until the pointer shape changes to crosshairs.

- b Click and drag the mouse to the upper edge of the `On` state. You then see a transition from the `InitializeSystem` state to the `On` state.
- c Double-click the transition to add this condition:

```
[all(sensors>0)]
```

This transition condition verifies if all of the sensors have values greater than zero.

- 3 Repeat these steps to create these remaining transition conditions.

Transition	Condition
On to FailState	[Alarm == 1]
FailState to InitializeSystem	[Alarm == 0]

- 4 Draw another transition from `InitializeSystem` to `FailState`. On this transition, type the following to create the transition event:

```
after(5,sec)
```

If the sensors have not turned on after 5 seconds, this syntax specifies a transition from `InitializeSystem` to `FailState`.

Note The syntax on this transition is an event rather than a transition condition. For details, refer to “Control Chart Execution by Using Temporal Logic” on page 13-40.

The chart now looks like this figure.

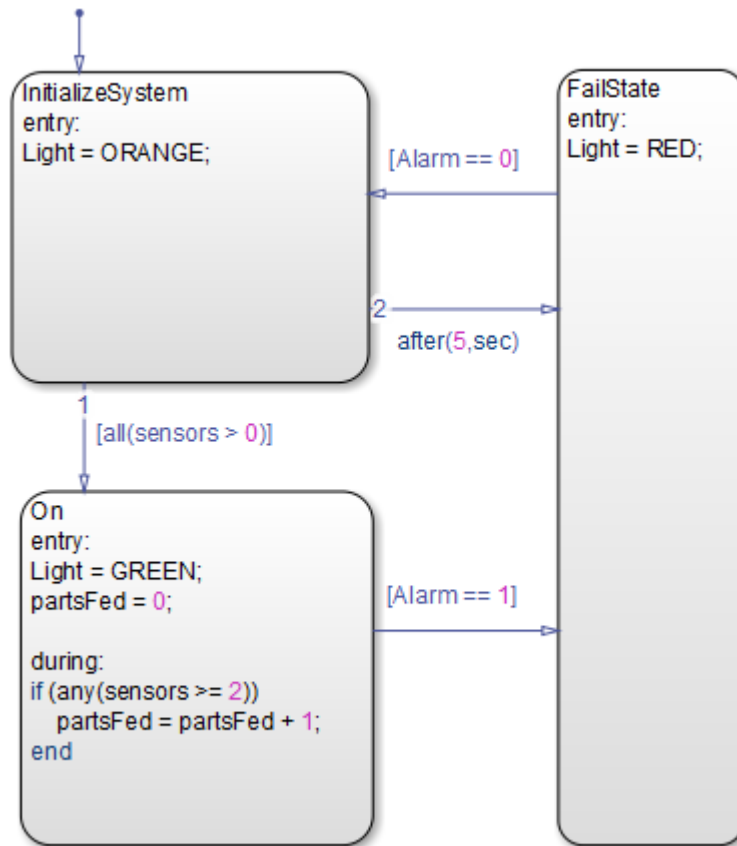

Note The outgoing transitions from `InitializeSystem` have a small label 1 and 2 to indicate the order in which transition segments are evaluated. If the numbers from the figure do not match your model, right click the transition and then change it by clicking on `Execution Order`. See “Transition Evaluation Order” on page 3-38 for details.

Define Data for Your System

Verify the Chart Data Properties

Start the simulation of your model. Errors about unresolved symbols appear, along with the Symbol Wizard.

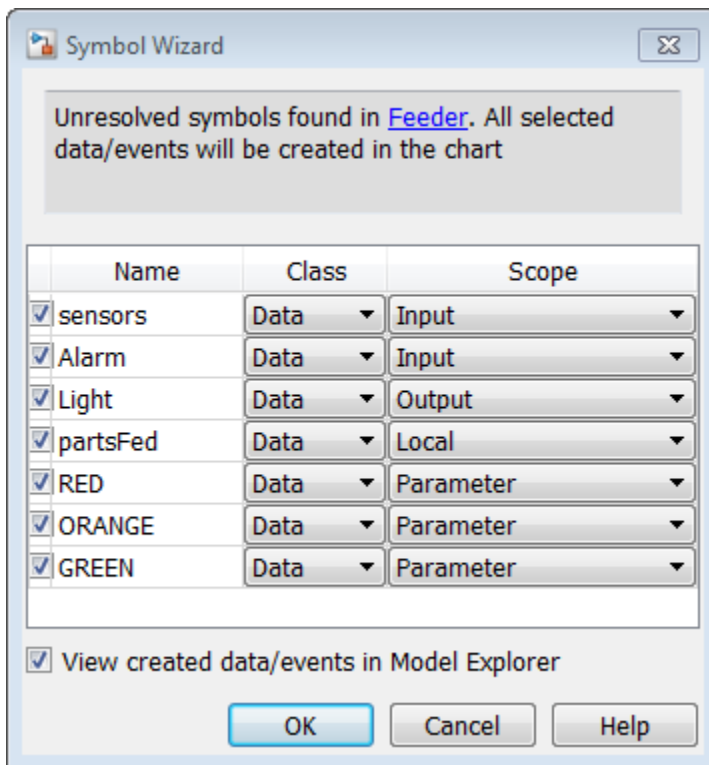

The Symbol Wizard does not automatically add any data to your chart. It identifies the unresolved data and infers the class and scope of that data using the inference rules of MATLAB expressions in Stateflow actions. In the chart:

- Data that is read from but not written to is inferred as *input* data. However, if the name of the data is in all uppercase letters, the Symbol Wizard infers the data as a *parameter*
- Data that is written to but not read from is inferred as *output* data.
- Data that is read from and written to is inferred as *local* data.

The Symbol Wizard infers the scope of the input data in your chart. However, you must fix the data scope for the `partsFed` Output. Follow these steps:

- 1 For the **partsFed** data: in the **Data Scope** column, select **Output** from the list

The Symbol Wizard now looks like this figure.

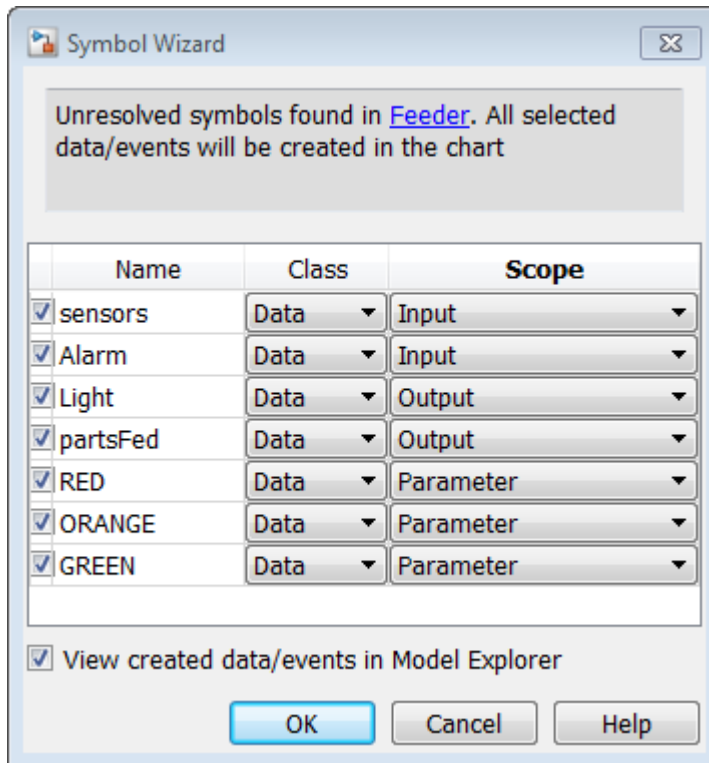

- 2 To add the data that the Symbol Wizard suggests, click **OK**.
- 3 Add initial values for the parameters. At the MATLAB command prompt, enter:

```
RED = 0;
```

- 4 Similarly, at the MATLAB command prompt, add the following initial values for the remaining parameters:

Parameter	Value
RED	0
ORANGE	1
GREEN	2

- 5 Return to the model and connect the inputs and outputs to their respective ports.

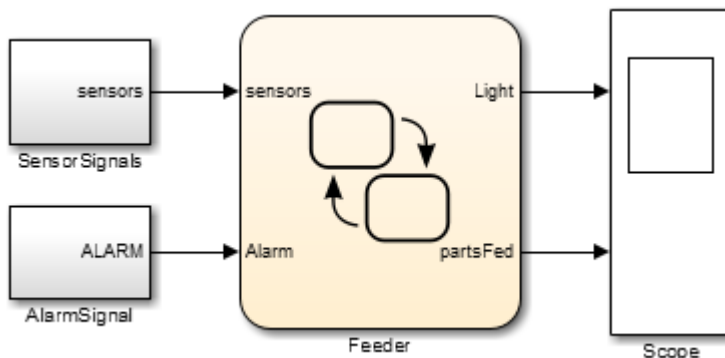

Verify the System Representation

- 1 Start the simulation.

Double-click the Scope block to verify that the model captures the expected feeder behavior.

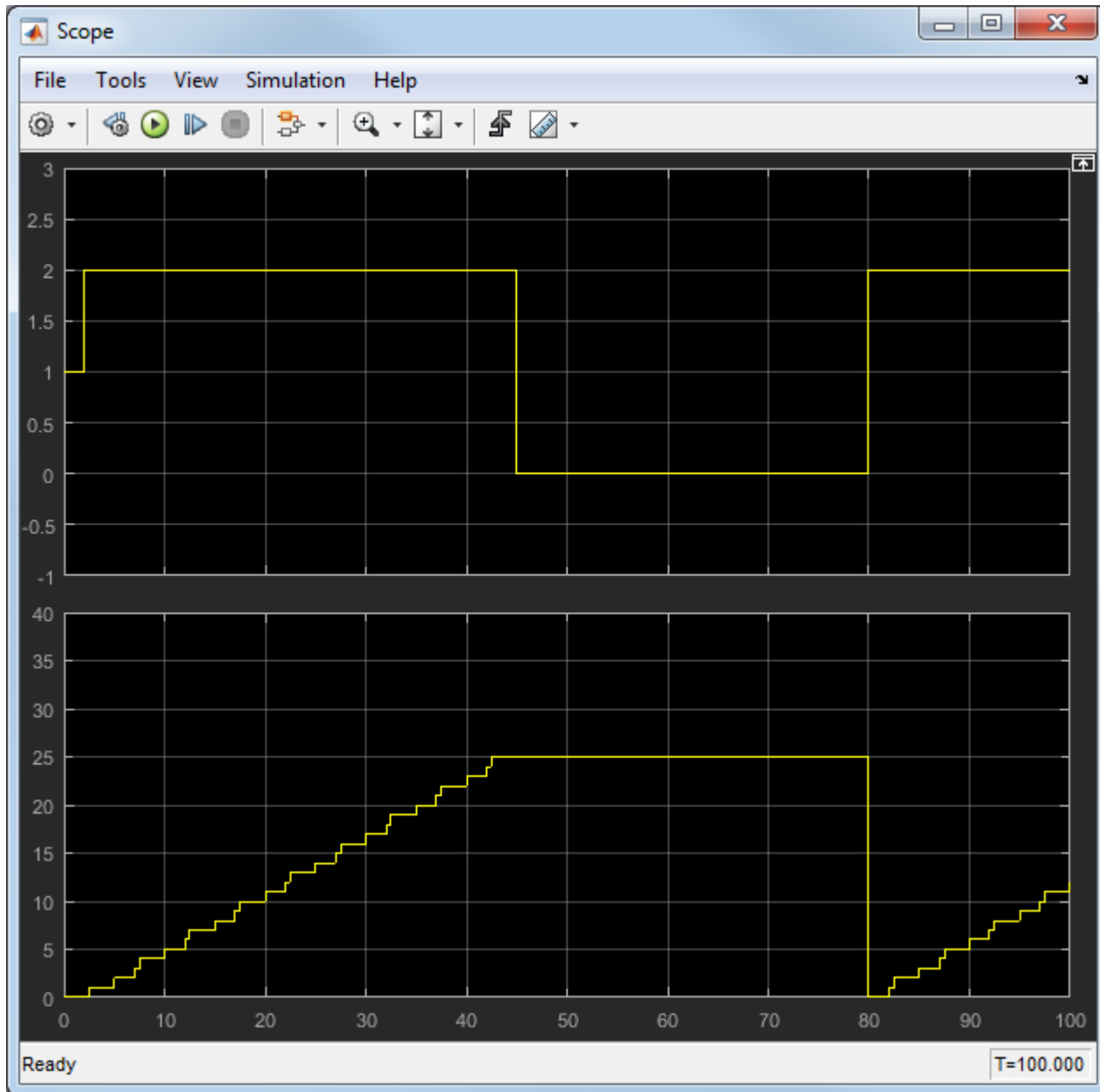

The upper axis shows the LED signal which varies between orange (1), green (2), and red (0) to indicate the current operating mode. The lower axis shows the number of parts fed to the next assembly station, which increases incrementally until the alarm signal turns the machine off and then resets.

Alternative Approach: Event-Based Chart

Another approach to programming the chart is to start by identifying parts of the system interface, such as events to which your system reacts.

In the previous example, when you use input data to represent an event, the chart wakes up periodically and verifies whether the conditions on transitions are valid. In this case, if `ALARM == 1`, then the transition to the failure state happens at the next time step. However, creating a Stateflow chart which reacts to input events allows you to react to the alarm signal when the event is triggered.

For details on when to use an event-based chart, see “Synchronize Model Components by Broadcasting Events” on page 11-2.

Identify System Attributes for Event-Driven Systems

In the event-based approach, the system attributes to consider first are the events, inputs, and outputs.

In the following table, consider the characteristics of the event-driven Feeder Model that are different from the system based on transition conditions.

Attributes	Characteristics
Events	Two asynchronous events: an alarm signal and an all-clear signal
Inputs	Three sensor readings to detect if a part has moved to a downstream assembly station

Feeder Chart Activated by Input Events

In this example, the feeder model reacts to input events using a triggered chart.

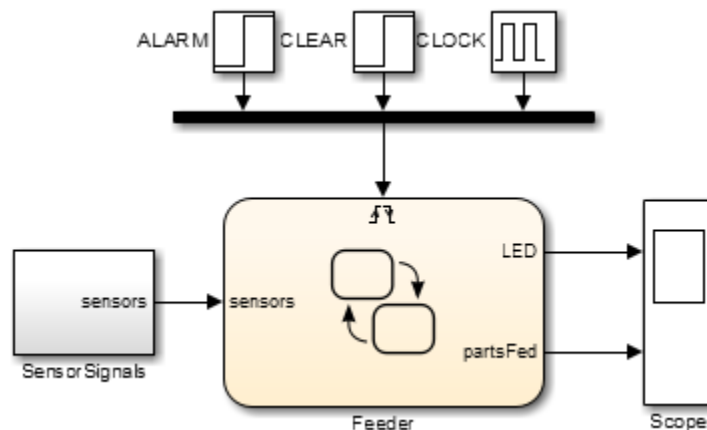

The chart now has only one input port on the left and an event triggered input on the top. For more information on how to create a Stateflow chart activated by events, see “Activate a Stateflow Chart by Sending Input Events” on page 11-7

When the ALARM signal triggers the chart, the chart responds to the trigger in that time step. If the current state is On when the alarm is triggered, then the current state transitions to FailState.

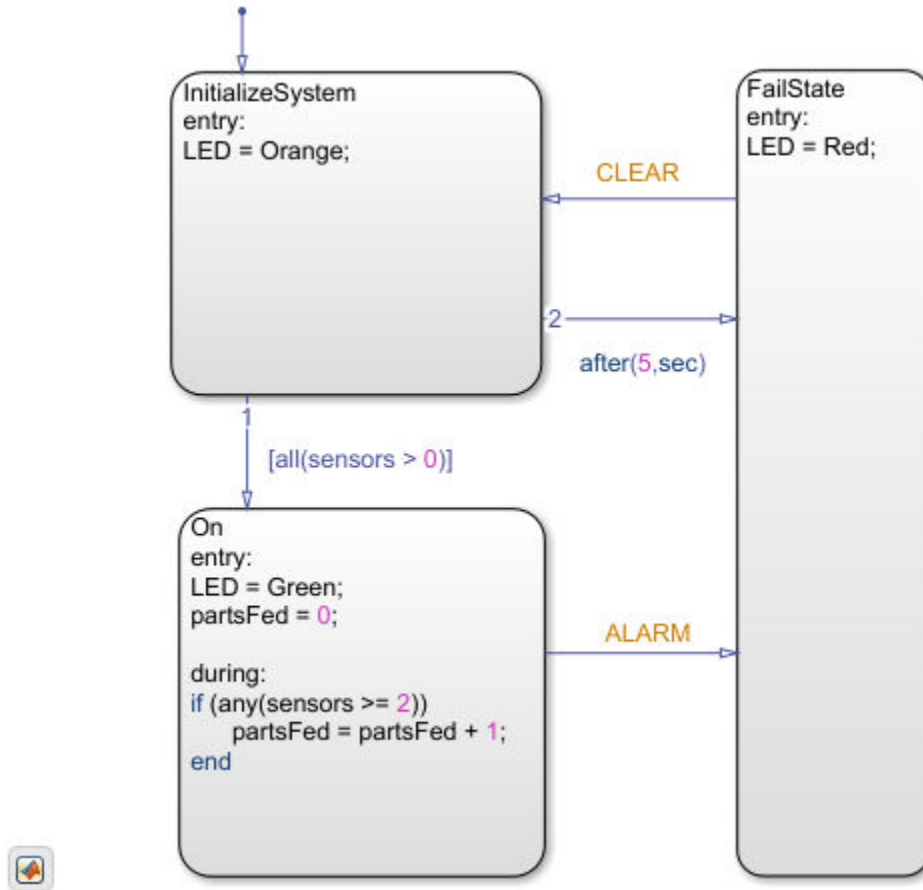

The scope output for the Event-triggered chart is in the following figure.

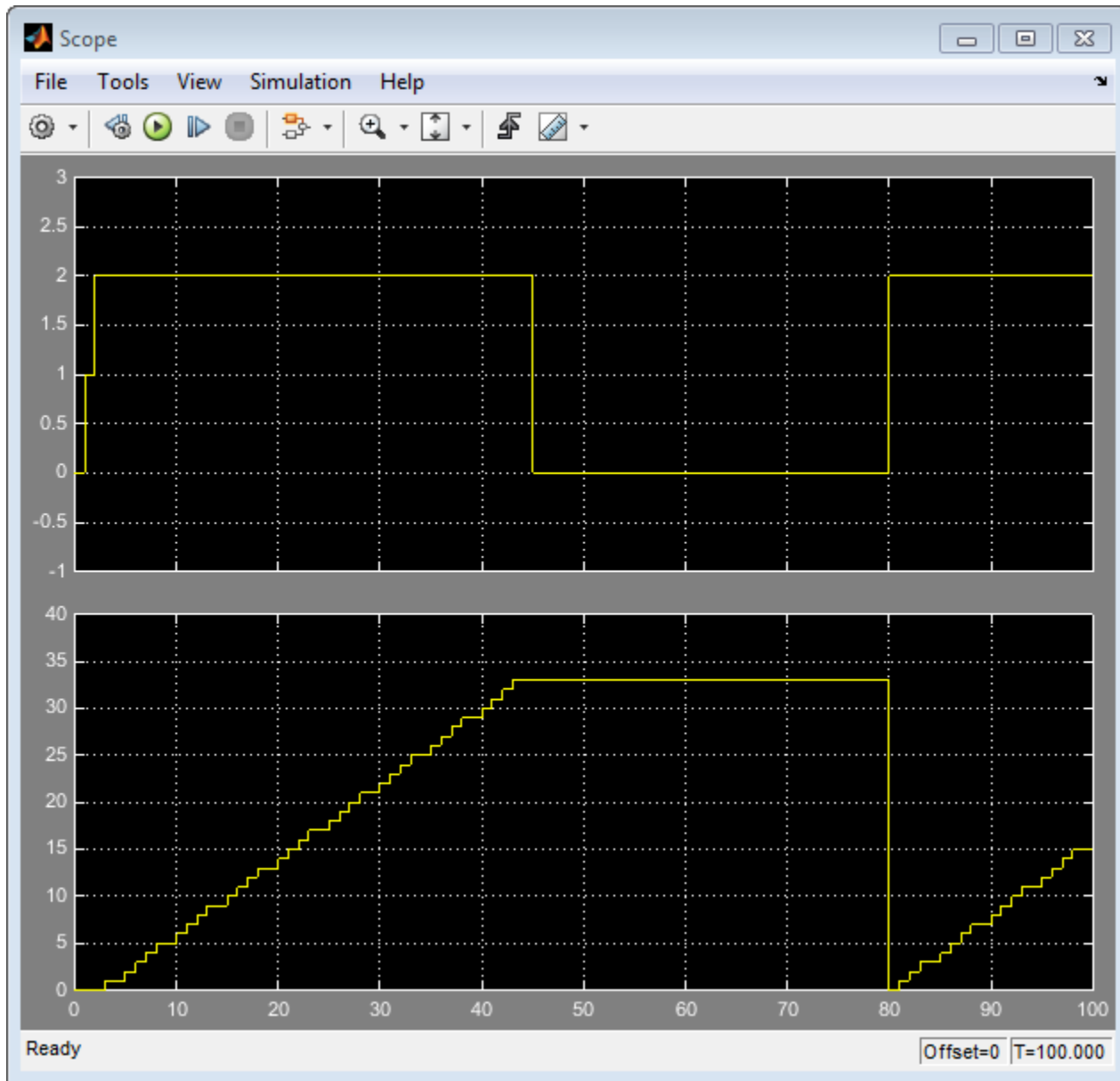

The upper axis shows the LED signal which varies between red (0), orange (1), and green (2) to indicate the current operating mode. The lower axis shows the number of parts fed to the next assembly station, which increases incrementally until the alarm signal turns the machine off and then resets. However, the event-based simulation feeds more parts to the next assembly station due to clock and solver differences.

Tabular Expression of Modal Logic

- “State Transition Tables in Stateflow” on page 15-2
- “State Transition Table Operations” on page 15-8
- “Highlight Flow of Logic in a State Transition Table” on page 15-10
- “State Transition Table Diagnostics” on page 15-12
- “Model Bang-Bang Controller by Using a State Transition Table” on page 15-13
- “Debug Run-Time Errors in a State Transition Table” on page 15-25

State Transition Tables in Stateflow

A state transition table is an alternative way of expressing sequential modal logic. Instead of drawing states and transitions graphically in a Stateflow chart, use state transition tables to express the modal logic in tabular format. State transition tables are supported only as blocks in a Simulink model.

Benefits of using state transition tables include:

- Ease of modeling train-like state machines, where the modal logic involves transitions from one state to its neighbor
- Concise, compact format for a state machine
- Reduced maintenance of graphical objects

When you add or remove states from a chart, you have to rearrange states, transitions, and junctions. When you add or remove states from a state transition table, you do not have to rearrange any graphical objects.

State transition tables support using MATLAB and C as the action language. For more information about the differences between these action languages, see “Differences Between MATLAB and C as Action Language Syntax” on page 14-5.

The following state transition table contains the modal logic for maintaining the temperature of a boiler between two set points:

STATES	TRANSITIONS	
	IF	ELSE-IF(2)
Normal 	[ALARM]	
	Alarm	
Off entry: boiler_cmd = 0; doneWarmup = false;	[temp <= reference_low]	
	Warmup	
Warmup entry: boiler_cmd = 2;	[doneWarmup]	[after(10, sec)] {doneWarmup = true;}
	On	On
On entry: boiler_cmd = 1;	[temp >= reference_high]	
	Off	
Alarm entry: boiler_cmd = 0;	[CLEAR]	
	Normal	



This Stateflow chart represents the same modal logic:

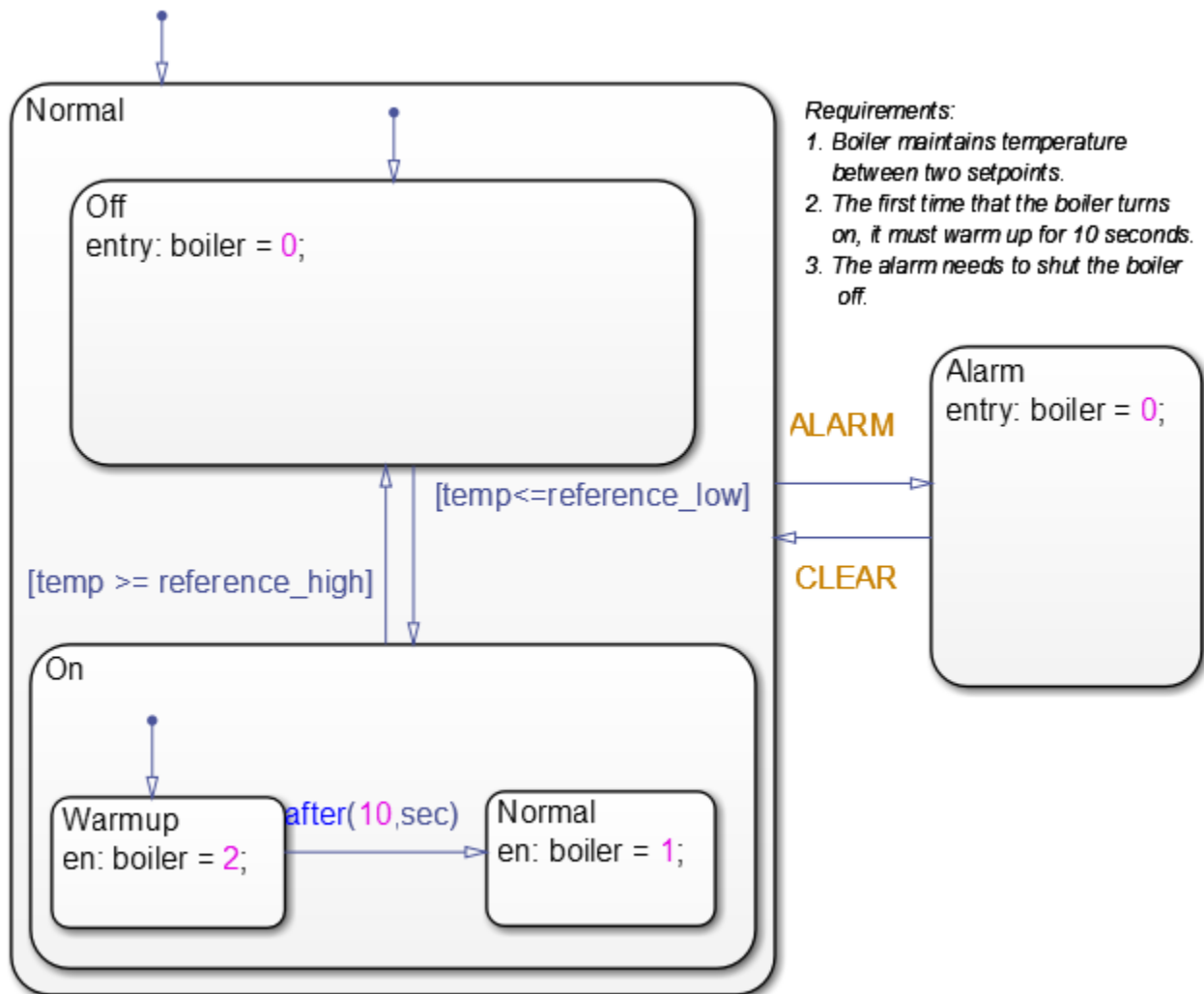

Rules for Using State Transition Tables

- If you specify an action in a transition cell, it must be a condition action.
- State transition tables must have at least one state row and one transition column.

Differences Between State Transition Tables and Charts

State transition tables support a subset of the most commonly used elements in Stateflow charts. Elements that state transition tables do not support include:

- Supertransitions
- Parallel (AND) decomposition
- Local events
- Flow charts
- Use of chart-level functions (graphical, truth table, MATLAB, and Simulink)

Anatomy of a State Transition Table

A state transition table contains the following components:

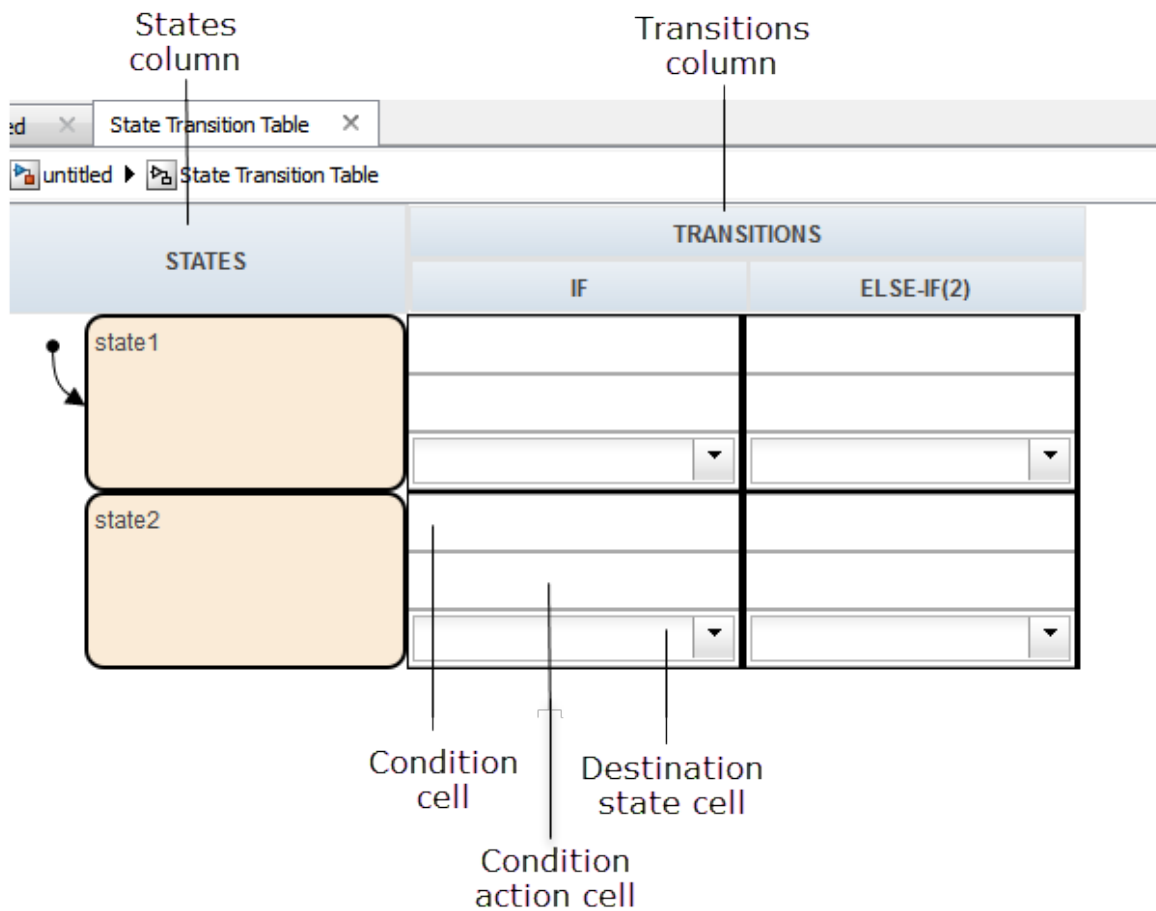

Each transition column contains the following state-to-state transition information:

- Condition
- Condition action
- Destination state

Create State Transition Table and Specify Properties

How to Create a New State Transition Table

At the MATLAB command prompt, enter:

```
sfnew(' -STT')
```

From the Simulink Library Browser:

- 1 Select the Stateflow library.
- 2 Drag a state transition table into your model.



Properties for State Transition Tables

To access properties, in the Stateflow Editor, in the **Modeling** tab, click **Table Properties**.

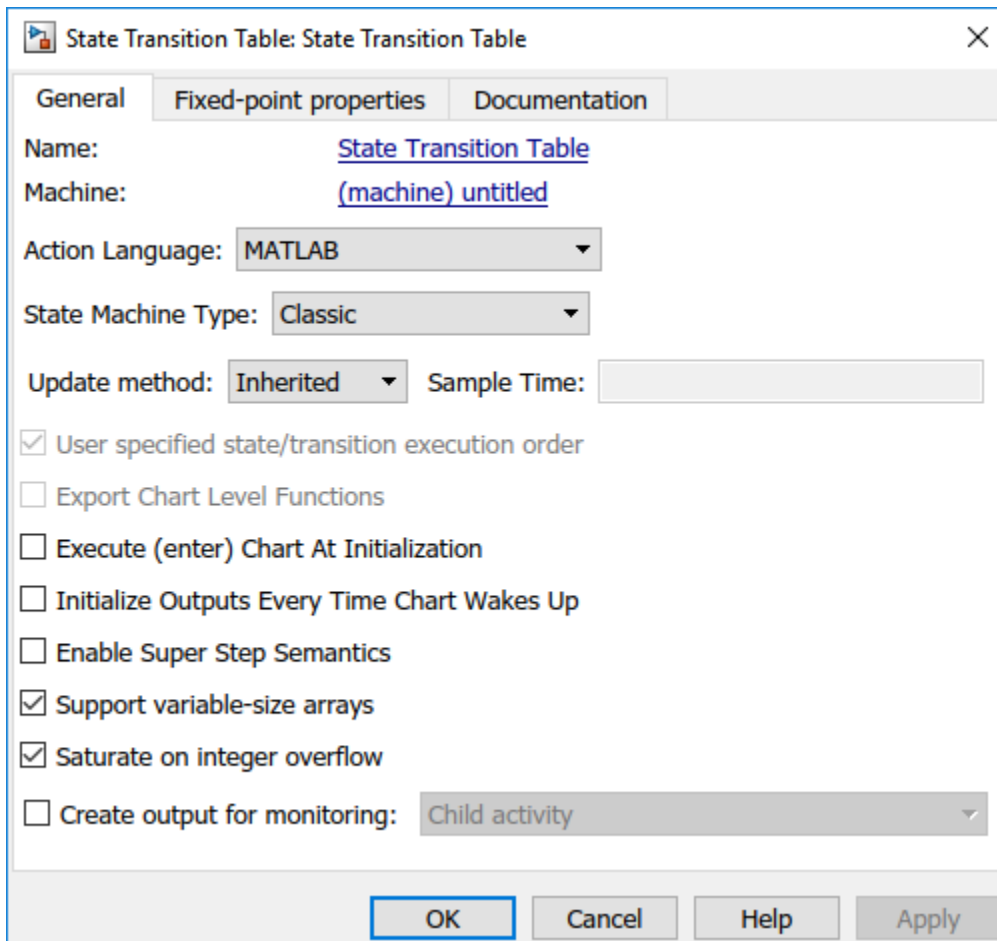

These properties are the same as those for charts that use MATLAB as the action language. For a description of each property, see “Specify Properties for Stateflow Charts” on page 25-2.

Generate Diagrams from State Transition Tables

Stateflow software automatically generates a read-only state transition diagram from the state transition table you create. As you enter changes to a state transition table, Stateflow incrementally updates the diagram as well. To see the most up-to-date version of the underlying diagram, in the **Debug** tab, click **Show Auto Chart**.

See Also

State Transition Table

More About

- “State Transition Table Operations” on page 15-8
- “Debug Run-Time Errors in a State Transition Table” on page 15-25
- “Model Bang-Bang Controller by Using a State Transition Table” on page 15-13

State Transition Table Operations

A state transition table is an alternative way of expressing sequential modal logic. Instead of drawing states and transitions graphically in a Stateflow chart, use state transition tables to express the modal logic in tabular format. State transition tables are supported only as blocks in a Simulink model. For more information, see “State Transition Tables in Stateflow” on page 15-2.

To create state transition tables, use the Stateflow Editor. You can insert, edit, and move rows and columns. You can also add history junctions and set the default state for the state transition table.

Insert Rows and Columns

To insert a row:

- 1 Select an existing state.
- 2 In the **Modeling** tab, select one of the following options:

Option	Description
Insert State Row	Inserts a state at the same level of hierarchy.
Insert Child State Row	Inserts a state as a child of the selected state.
Insert Default Transition Path Row	Inserts a row for specifying conditional default transition paths.
Insert Inner Transition Path Row	Inserts a row for specifying inner transitions from the selected parent state to its child states. This row type can only be added to states with children states.

To insert a column:

- 1 In the **Modeling** tab, click **Append Transition Col**. A new `else-if` column appears to the right of the last column.

Move Rows and Cells

To move a row, click the state cell and drag the row to a new location. As you drag the row, you see a visual indicator of where in the hierarchy the state will appear in its new position.

To move a transition cell, click anywhere in the cell and drag the condition, action, and destination cells as a unit to a new location. The transition cell you displace moves one cell to the right. If column does not exist, Stateflow creates one. The state transition table prevents you from moving cells to an invalid destination and alerts you to the problem.

Copy Rows and Transition Cells

To copy a row:

- 1 Right-click the state in the row you want to copy and select **Copy**.
- 2 Right-click the state in the destination row and select **Paste**.

The row appears above the destination row.

To copy a transition cell:

- 1 Right-click a cell and select **Copy**.
- 2 Right-click a destination cell of the same type and select **Paste**.

The new content overwrites the existing content at the destination. The state transition table prevents you from copying content to an invalid destination.

Set Default State

Right-click the state and select **Set to default**.

Add History Junction

You can add history junctions to states that have children. Right-click the state and select **Add history junction**.

Print State Transition Tables

To print a copy of the state transition table, press **Ctrl+P (Command+P)**.

Select and Clear Table Elements

Task	Action
Select a cell for editing	Click the cell.
Exit edit mode in a cell	Press Esc or click another table, cell, row, or column.

Undo and Redo Edit Operations

To undo the effects of the previous operation, press **Ctrl+Z (Command+Z)**.

To redo the effects of the previous operation, press **Ctrl+Y (Command+Y)**.

You can undo and redo up to 10 operations.

See Also

More About

- “State Transition Tables in Stateflow” on page 15-2
- “Debug Run-Time Errors in a State Transition Table” on page 15-25
- “View Sequential Logic Through State Transition Matrix”

Highlight Flow of Logic in a State Transition Table

A state transition table is an alternative way of expressing sequential modal logic. Instead of drawing states and transitions graphically in a Stateflow chart, use state transition tables to express the modal logic in tabular format. State transition tables are supported only as blocks in a Simulink model. For more information, see “State Transition Tables in Stateflow” on page 15-2.

To visualize a flow of logic, you can highlight one transition cell per row in your state transition table. Highlighting can be used to show the primary flow of logic from one state to another or the flow that represents an error condition.

The highlighting persists across MATLAB sessions and appears in the autogenerated state transition diagram and the state transition table.

To highlight transition cells:

- 1 In the transition table editor, right-click the transition cell and select **Mark as primary transition**.

The transition cell appears with a red border.

- 2 To complete the flow, highlight additional cells, one per row.

For example:

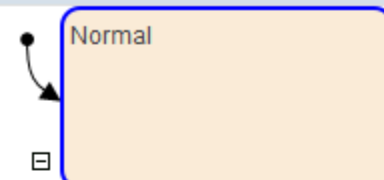
STATES	TRANSITIONS	
	IF	ELSE-IF(2)
Normal 	[ALARM]	
	Alarm	
Off entry: boiler_cmd = 0; doneWarmup = false;	[temp <= reference_low]	
	Warmup	
Warmup entry: boiler_cmd = 2;	[doneWarmup]	[after(10, sec)]
	On	{doneWarmup = true;}
On entry: boiler_cmd = 1;	[temp >= reference_high]	
	Off	
Alarm entry: boiler_cmd = 0;	[CLEAR]	
	Normal	

- To view the flow in the autogenerated state diagram, in the **Debug** tab, click **Show Auto Chart**.

The transitions that represent the flow appear highlighted in the diagram.

See Also

More About

- “State Transition Tables in Stateflow” on page 15-2
- “Model Bang-Bang Controller by Using a State Transition Table” on page 15-13
- “Debug Run-Time Errors in a State Transition Table” on page 15-25

State Transition Table Diagnostics

A state transition table is an alternative way of expressing sequential modal logic. Instead of drawing states and transitions graphically in a Stateflow chart, use state transition tables to express the modal logic in tabular format. State transition tables are supported only as blocks in a Simulink model. For more information, see “State Transition Tables in Stateflow” on page 15-2.

You can run diagnostic checks on a state transition table. From the Stateflow Editor, in the **Debug** tab, select **Update Model > Update Table**.

The diagnostics tool statically parses the table to find errors such as:

- States with no incoming transitions
- Transition cells with conditions or actions, but no destination
- Action text in a condition cell
- States that are unreachable from the default transition
- Default transition row without unconditional transition
- Inner transition row execution order mismatches. The inner transition row for a state must specify destination states from left to right in the same order as the corresponding states appear in the table, from top to bottom.

Each error is reported with a hyperlink to the corresponding object causing the error. These checks are also performed during simulation.

See Also

More About

- “State Transition Tables in Stateflow” on page 15-2
- “Debug Run-Time Errors in a State Transition Table” on page 15-25
- “Model Bang-Bang Controller by Using a State Transition Table” on page 15-13

Model Bang-Bang Controller by Using a State Transition Table

A state transition table is an alternative way of expressing sequential modal logic. Instead of drawing states and transitions graphically in a Stateflow chart, use state transition tables to express the modal logic in tabular format. State transition tables are supported only as blocks in a Simulink model. For more information, see “State Transition Tables in Stateflow” on page 15-2.

Design Requirements

This example shows how to model a bang-bang controller for temperature regulation of a boiler, using a state transition table. The controller must turn the boiler on and off to meet the following design requirements:

- High temperature cannot exceed 25 degrees Celsius.
- Low temperature cannot fall below 23 degrees Celsius.
- Steady-state operation requires a warm-up period of 10 seconds.
- When the alarm signal sounds, the boiler must shut down immediately.
- When the all-clear signal sounds, the boiler can turn on again.

Identify System Attributes

You can identify the operating modes and data requirements for the bang-bang controller based on its design requirements.

Operating Modes

The high-level operating modes for the boiler are:

- Normal operation, when no alarm signal sounds.
- Alarm state, during an alarm signal.

During normal operation, the boiler can be in one of three states:

- Off, when the temperature is above 25 degrees Celsius.
- Warm-up, during the first 10 seconds of being on.
- On, steady-state after 10 seconds of warm-up, when the temperature is below 23 degrees Celsius.

Data Requirements

The bang-bang controller requires the following data.

Scope	Description	Variable Name
Input	High temperature set point	reference_high
Input	Low temperature set point	reference_low
Input	Alarm indicator	ALARM
Input	All-clear indicator	CLEAR
Input	Current temperature of the boiler	temp

Scope	Description	Variable Name
Local	Indicator that the boiler completed warm-up	doneWarmup
Output	Command to set the boiler mode: off, warm-up, or on	boiler_cmd

Build the Controller or Use the Supplied Model

To build the bang-bang controller model yourself using a state transition table, follow these exercises. Otherwise, you can open the completed model.

Create a New State Transition Table

To represent the bang-bang controller, use a state transition table. Compared to a graphical state transition diagram, the state transition table is a compact way to represent modal logic that involves transitions between neighboring states. For this example, use MATLAB as your action language.

- 1 Open the partially built boiler plant model.

This model contains all required Simulink blocks, except for the bang-bang controller.

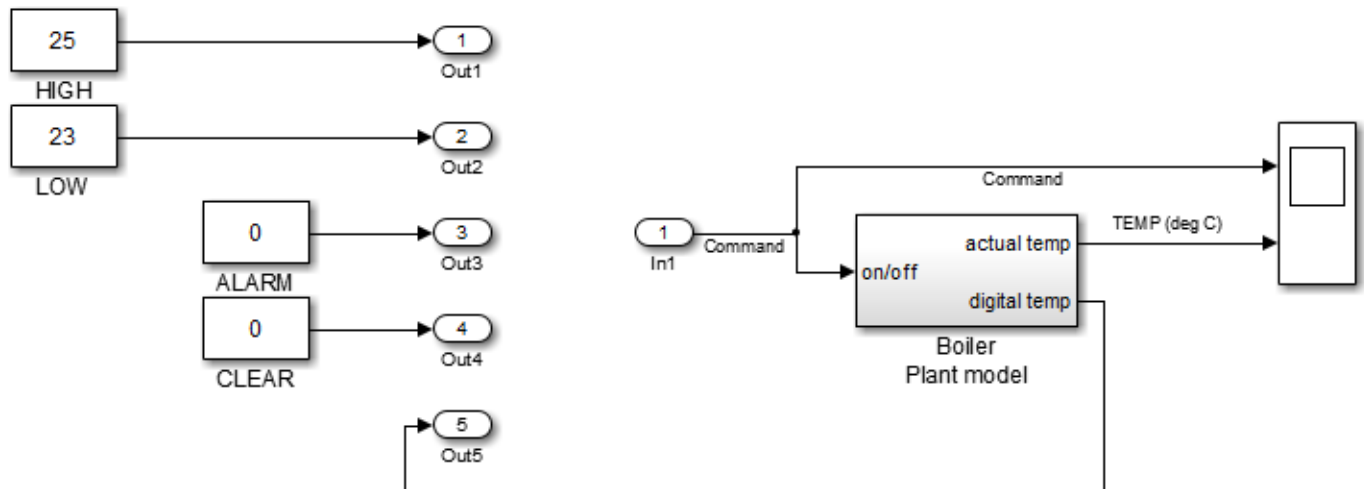

- 2 Delete the five output ports and the single input port.
- 3 Open the Library Browser. In the **Simulation** tab, click **Library Browser**.
- 4 In the left pane of the Library Browser, select the Stateflow library, then drag a State Transition Table block from the right pane into your boiler model.

Your model looks like this model.

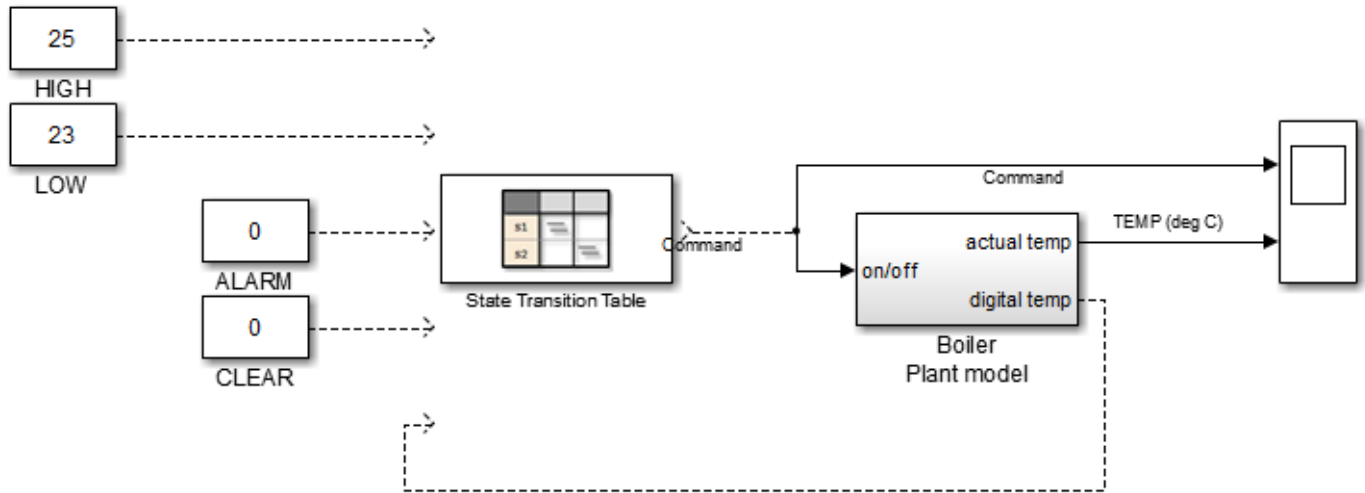

5 Close the Library Browser.

Now you are ready to add states and hierarchy to the state transition table.





Add States and Hierarchy

To represent the operating modes of the boiler, add states and hierarchy to the state transition table.

- 1 Open the state transition table.
- 2 Represent the high-level operating modes: normal and alarm.
 - a Double-click `state1` and rename it `Normal`.
 - b Double-click `state2` and rename it `Alarm`.
- 3 Represent the three states of normal operation as substates of `Normal`:
 - a Right-click the `Normal` state, select **Insert Row > Child State Row**, and name the new state `Off`.
 - b Repeat step a two more times to create the child states `Warmup` and `On`, in that order.

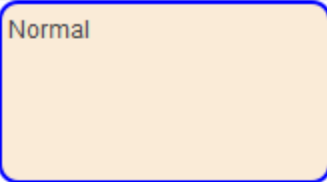
By default, when there is ambiguity, the top exclusive (OR) state at every level of hierarchy becomes active first. For this reason, the `Normal` and `Off` states appear with default transitions. This configuration meets the design requirements for this model. To set a default state, right-click the state and select **Set to default**.

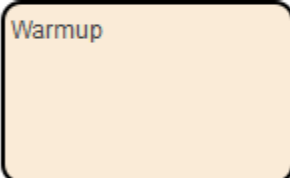
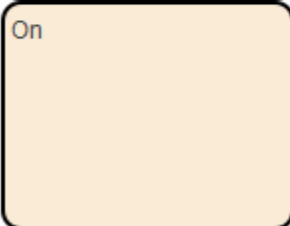
Your state transition table looks like this table.

STATES	TRANSITIONS	
	IF	ELSE-IF(2)
		
		
		
		
		

Now you are ready to specify actions for each state.

Specify State Actions

To describe the behavior that occurs in each state, specify state actions in the table. In this exercise, you initialize modes of operation as the boiler enters normal and alarm states, using the variables `boiler_cmd` and `doneWarmup` (described in “Data Requirements” on page 15-13).

- 1 In the following states, click after the state name, press **Enter**, and type the specified entry actions.

In State:	Type:	Resulting Behavior
Off	entry: boiler_cmd = 0; doneWarmup = false;	Turns off the boiler and indicates that the boiler has not warmed up.
Warmup	entry: boiler_cmd = 2;	Starts warming up the boiler.
On	entry: boiler_cmd = 1;	Turns on the boiler.
Alarm	entry: boiler_cmd = 0;	Turns off the boiler.

2 Save the state transition table.

Your state transition table looks like this table.

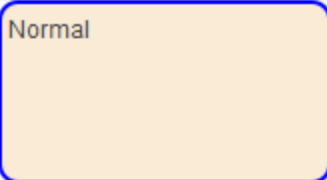
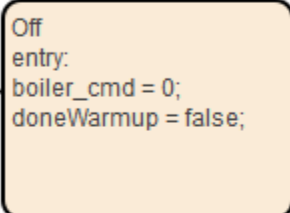
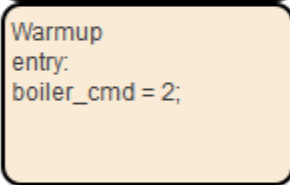
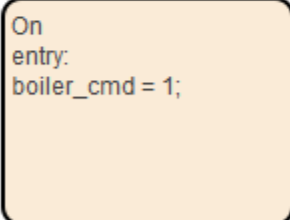
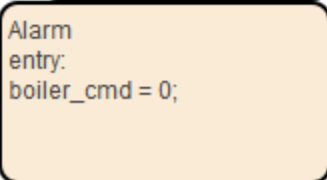
STATES	TRANSITIONS	
	IF	ELSE-IF(2)
 <p>Normal</p>		
 <p>Off entry: boiler_cmd = 0; doneWarmup = false;</p>		
 <p>Warmup entry: boiler_cmd = 2;</p>		
 <p>On entry: boiler_cmd = 1;</p>		
 <p>Alarm entry: boiler_cmd = 0;</p>		

Now you are ready to specify the conditions and actions for transitioning from one state to another state.

Specify Transition Conditions and Actions

To indicate when to change from one operating mode to another, specify transition conditions and actions in the table. In this exercise, you construct statements using variables described in “Data Requirements” on page 15-13.

- 1 In the Normal state row, enter:

if
[ALARM]

if
Alarm

During simulation:

- a When first entered, the chart activates the Normal state.
- b At each time step, normal operation cycles through the Off, Warmup, and On states until the ALARM condition is true.
- c When the ALARM condition is true, the boiler transitions to the Alarm state and shuts down immediately.

2 In the Off state row, enter:

if
[temp <= reference_low]
Warmup

During simulation, when the current temperature of the boiler drops below 23 degrees Celsius, the boiler starts to warm up.

3 In the Warmup state row, enter:

if	else-if
[doneWarmup]	[after(10, sec)]
	{doneWarmup = true;}
On	On

During simulation, the boiler warms up for 10 seconds and then transitions to the On state.

4 In the On state row, enter:

if
[temp >= reference_high]
Off

During simulation, when the current temperature of the boiler rises above 25 degrees Celsius, the boiler shuts off.

5 In the Alarm state row, enter:

if
[CLEAR]
Normal

During simulation, when the all-clear condition is true, the boiler returns to normal mode.

6 Save the state transition table.

Your state transition table looks like this table.

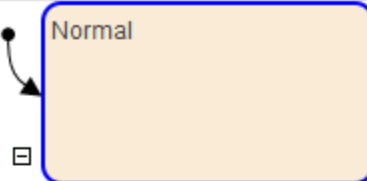
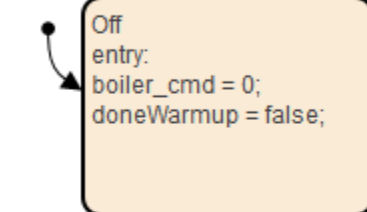
STATES	TRANSITIONS	
	IF	ELSE-IF(2)
 <p>Normal</p>	[ALARM]	
	Alarm	
 <p>Off entry: boiler_cmd = 0; doneWarmup = false;</p>	[temp <= reference_low]	
	Warmup	
<p>Warmup entry: boiler_cmd = 2;</p>	[doneWarmup]	[after(10, sec)] {doneWarmup = true;}
	On	On
<p>On entry: boiler_cmd = 1;</p>	[temp >= reference_high]	
	Off	
<p>Alarm entry: boiler_cmd = 0;</p>	[CLEAR]	
	Normal	

Now you are ready to add data definitions using the Symbol Wizard.

Define Data

When you create a state transition table that uses MATLAB syntax, there are language requirements for C/C++ code generation. One of these requirements is that you define the size, type, and complexity of all MATLAB variables so that their properties can be determined at compile time. Even though you have not yet explicitly defined the data in your state transition table, you can use the Symbol Wizard. During simulation, the Symbol Wizard alerts you to unresolved symbols, infers their properties, and adds the missing data to your table.

- 1 In the Simulink model , select **Run**.

Two dialog boxes appear:

- The Diagnostic Viewer indicates that you have unresolved symbols in the state transition table.
- The Symbol Wizard attempts to resolve the missing data. The wizard correctly infers the scope of all data except for the inputs **ALARM** and **CLEAR**.

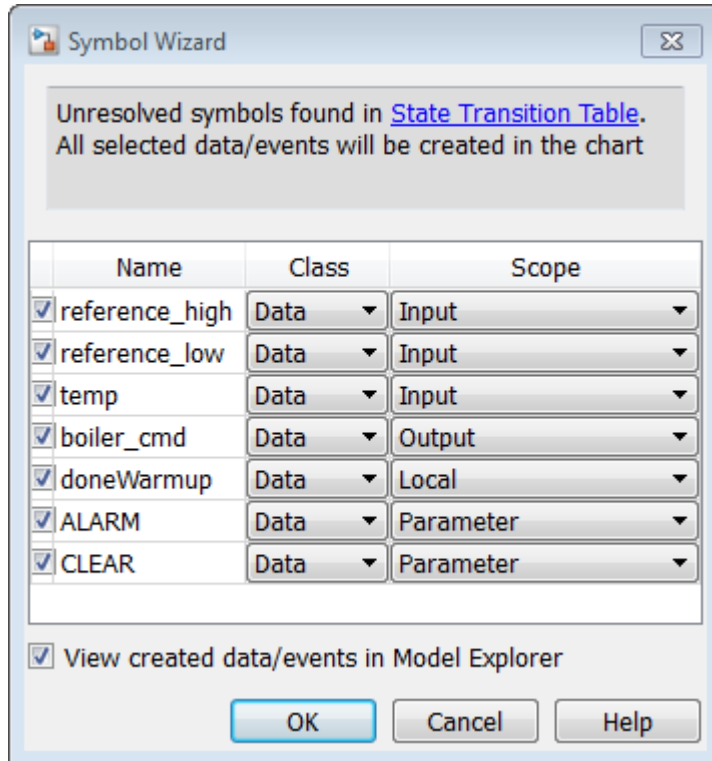

- 2 In the Symbol Wizard, correct the scopes of **ALARM** and **CLEAR** by selecting **Input** from their Scope drop-down lists.
- 3 When the Model Explorer opens, verify that the Symbol Wizard added all required data definitions correctly.

Some of the inputs are assigned to the wrong ports.

- 4 In the Contents pane of the Model Explorer, reassign input ports as follows:

Assign:	To Port:
reference_low	2
reference_high	1
temp	5
ALARM	3
CLEAR	4

- 5 Save the state transition table.

- 6 Close the Diagnostic Viewer and the Model Explorer.

In the Simulink model, the inputs and outputs that you defined appear in the State Transition Table block. Now you are ready to connect these inputs and outputs to the Simulink signals and run the model.

Connect the Transition Table and Run the Model

- 1 In the Simulink model, connect the state transition table to the Simulink inputs and outputs:

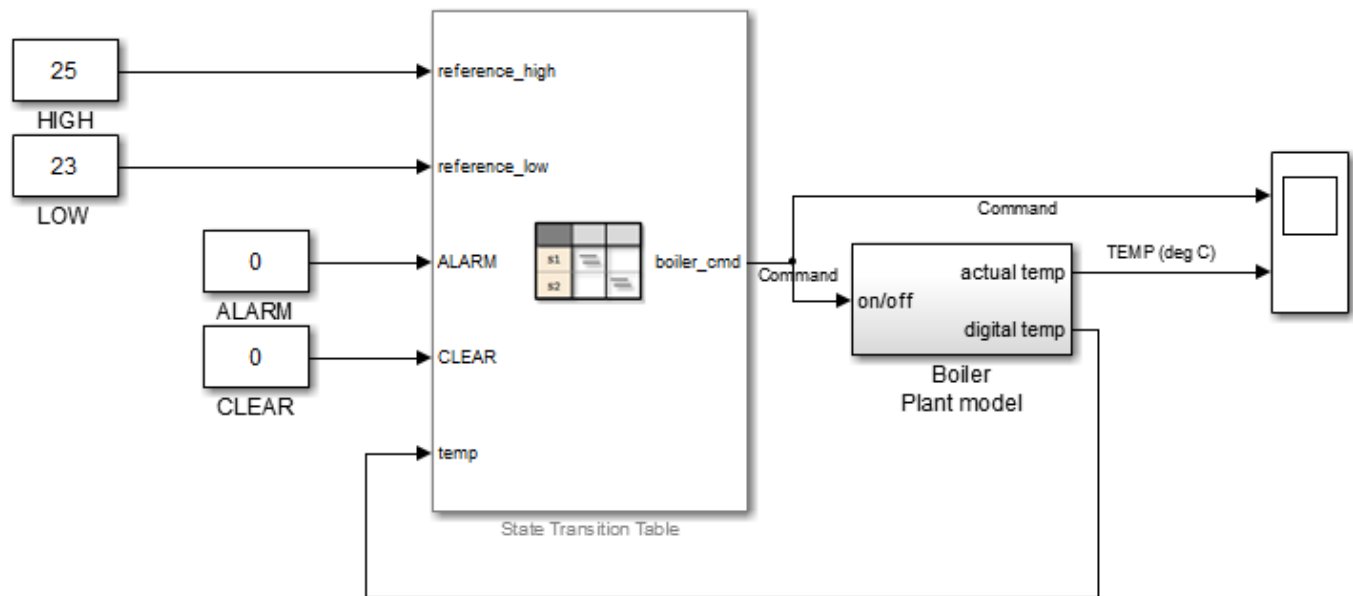

- 2 Save the model.
- 3 Reopen your state transition table.
- 4 Start the simulation by selecting **Run**.

As the simulation runs, you can watch the animation in the state transition table activate different states.

The following output appears in the Scope block.

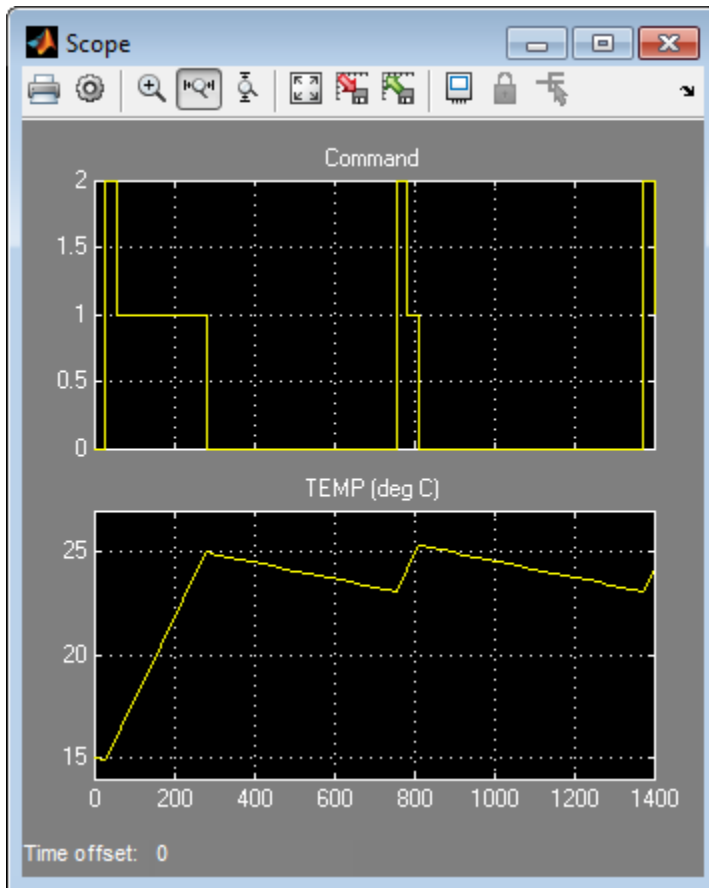

When performing interactive debugging, you can set breakpoints on different states and view the data values at different points in the simulation. For more information about debugging, see “Debugging Stateflow Charts” on page 33-2.

View the Graphical Representation

Stateflow automatically generates a read-only graphical representation of the state transition table you created.

- 1 In the **Debug** tab, click **Show Auto Chart**.

The top-level state transition diagram:

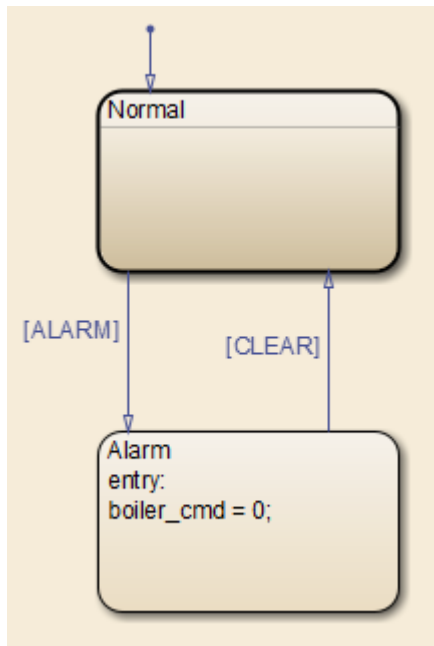

The Normal state appears as a subchart.

- 2 To view the states and transitions the chart contains, double-click the Normal state.

See Also

More About

- “State Transition Tables in Stateflow” on page 15-2
- “State Transition Table Operations” on page 15-8
- “Debug Run-Time Errors in a State Transition Table” on page 15-25

Debug Run-Time Errors in a State Transition Table

A state transition table is an alternative way of expressing sequential modal logic. Instead of drawing states and transitions graphically in a Stateflow chart, use state transition tables to express the modal logic in tabular format. State transition tables are supported only as blocks in a Simulink model. For more information, see “State Transition Tables in Stateflow” on page 15-2.

Create the Model and the State Transition Table

- 1 Create a Simulink model with a new State Transition Table (`sfnew -stt`).
- 2 Add the following states and transitions to your table:

STATES	TRANSITIONS	
	IF	ELSE-IF(2)
Power_off	[SWITCH]	
	Power_on	
Power_on	[SWITCH]	
	Power_off	
First	[Shift == 1]	
	Second	
Second	[Shift == 1]	
	Third	
Third	[Shift == 1]	
	First	

The table has two states at the highest level in the hierarchy, `Power_off` and `Power_on`. By default, `Power_off` is active. The event `SWITCH` toggles the system between the `Power_off` and `Power_on` states. `Power_on` has three substates: `First`, `Second`, and `Third`. By default, when `Power_on` becomes active, `First` also becomes active. When `Shift` equals 1, the system transitions from `First` to `Second`, `Second` to `Third`, and `Third` to `First`, for each occurrence of the event `SWITCH`. Then the pattern repeats.

- 3 Add two inputs on page 9-2 from Simulink:
 - An event called SWITCH with a scope of **Input from Simulink** and a **Rising** edge trigger.
 - A data called Shift with a scope of **Input from Simulink**.
- 4 In the model view, connect a Sine Wave block as the SWITCH event and a Step block as the Shift data for your State Transition Table.

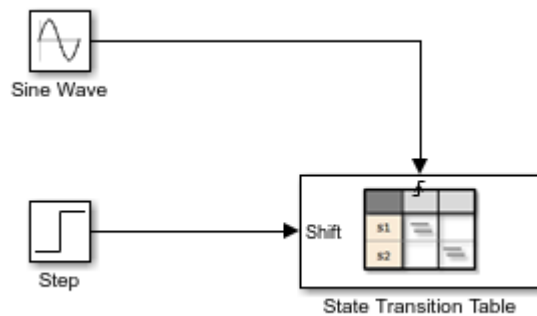

In the model, there is an event input and a data input. A Sine Wave block generates a repeating input event that corresponds with the Stateflow event SWITCH. The Step block generates a repeating pattern of 1 and 0 that corresponds with the Stateflow data object Shift. Ideally, the SWITCH event occurs at a frequency that allows at least one cycle through First, Second, and Third.

Debug the State Transition Table

To debug the table in “Create the Model and the State Transition Table” on page 15-25, follow these steps:

- 1 Right-click the Power_off state, and select **Set Breakpoint > On State Entry**.
- 2 Start the simulation.

Because you specified a breakpoint on Power_off, execution stops at that point.

- 3 Move to the next step by clicking the Step In button, .

- 4 To see the data used and the current values, hover your cursor over the different table cells.

Continue clicking the Step In button and watching the animating states. After each step, watch the chart animation to see the sequence of execution. Use the tooltips to see the data values.

Single-stepping shows that the loop from First to Second to Third inside the state Power_on does not occur. The transition from Power_on to Power_off takes priority.

Correct the Run-Time Error

In “Debug the State Transition Table” on page 15-26, you step through a simulation of a state transition table and find an error. The event SWITCH drives the simulation, but the simulation time passes too quickly for the input data object Shift to have an effect.

To correct this error:

- 1 Stop the simulation so that you can edit the table.
- 2 Add the condition `after(20.0, sec)` to the transition from `Power_on` to `Power_off`.

STATES	TRANSITIONS	
	IF	ELSE-IF(2)
Power_off	[SWITCH]	
	Power_on	
Power_on	[SWITCH && after(20.0,sec)]	
	Power_off	
First	[Shift == 1]	
	Second	
Second	[Shift == 1]	
	Third	
Third	[Shift == 1]	
	First	

Now the transition from `Power_on` to `Power_off` does not occur until 20 seconds have passed.

- 3 Begin simulation.
- 4 Click the Step In button repeatedly to observe the fixed behavior.

See Also

Related Examples

- “State Transition Tables in Stateflow” on page 15-2
- “State Transition Table Diagnostics” on page 15-12
- “Model Bang-Bang Controller by Using a State Transition Table” on page 15-13

Make States Reusable with Atomic Subcharts

- “Create Reusable Subcomponents by Using Atomic Subcharts” on page 16-2
- “Rules for Using Atomic Subcharts” on page 16-7
- “Map Variables for Atomic Subcharts and Boxes” on page 16-11
- “Reuse a State Multiple Times in a Chart” on page 16-23
- “Reduce the Compilation Time of a Chart” on page 16-29
- “Divide a Chart into Separate Units” on page 16-32
- “Generate Separate Code for an Atomic Subchart” on page 16-35
- “Model a Redundant Sensor Pair by Using Atomic Subcharts” on page 16-39
- “Model an Elevator System by Using Atomic Subcharts” on page 16-43

Create Reusable Subcomponents by Using Atomic Subcharts

An *atomic subchart* is a graphical object that helps you to create independent subcomponents in a Stateflow chart. Atomic subcharts are supported only in Stateflow charts in Simulink models.

Atomic subcharts allow for:

- Reuse of the same state or subchart across multiple charts and models.
- Faster simulation after making small changes to a chart with many states or levels of hierarchy.
- Ease of team development when multiple people are working on different parts of the same chart.
- Manual inspection of generated code for a specific state or subchart in a chart.

An atomic subchart looks opaque and includes the label **Atomic** in the upper left corner. If you use a linked atomic subchart from a library, the label **Link** appears in the upper left corner.

Example of an Atomic Subchart

This example illustrates the difference between a normal subchart and an atomic subchart.

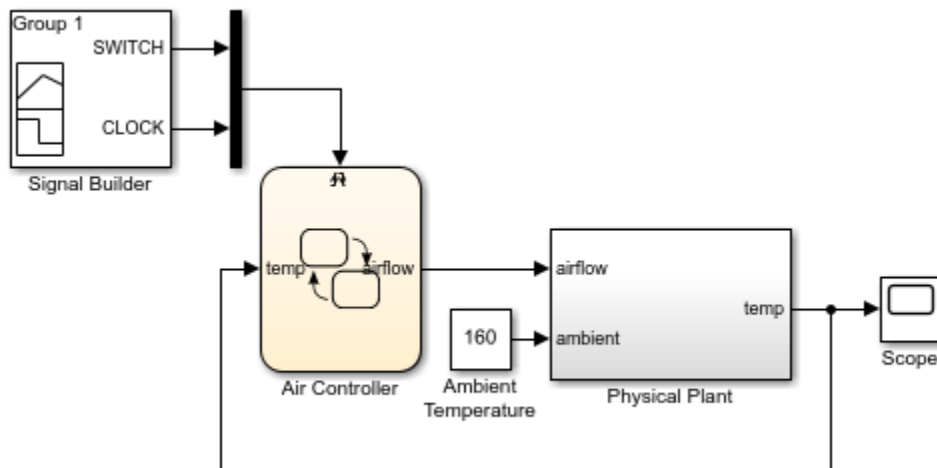

In the Air Controller chart, `PowerOff` is a normal subchart. `PowerOn` is an atomic subchart. Both subcharts look opaque, but the `PowerOn` includes the label **Atomic** on the upper left corner.

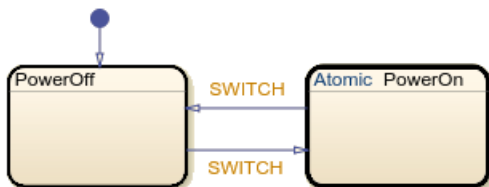

Benefits of Using Atomic Subcharts

Atomic subcharts combine the functionality of states on page 2-8, normal subcharts on page 8-4, and atomic subsystems. Atomic subcharts:

- Behave as independent charts.
- Support usage as library links.
- Support the generation of reusable code.
- Allow mapping of inputs, outputs, parameters, data store memory, and input events.

Atomic subcharts do not support access to:

- Data at every level of the chart hierarchy.
- Event broadcasts outside the scope of the atomic subchart.

Atomic subcharts do not support explicit specification of sample time.

Create an Atomic Subchart

You can create an atomic subchart by converting an existing subchart or by linking a chart from a library model. After creating the atomic subchart, update the mapping of variables by right-clicking the atomic subchart and selecting **Subchart Mappings**. For more information, see “Map Variables for Atomic Subcharts and Boxes” on page 16-11.

Convert a Normal Subchart to an Atomic Subchart

To create an independent component that allows for faster debugging and code generation workflows, convert an existing state or subchart into an atomic subchart. In your chart, right-click a state or a normal subchart and select **Group & Subchart > Atomic Subchart**. The label **Atomic** appears in the upper left corner of the subchart.

The conversion provides the atomic subchart with its own copy of every data object that the subchart accesses in the chart. Local data is copied as data store memory. The scope of other data, including input and output data, does not change.

For more information, see “Restrictions for Converting to Atomic Subcharts” on page 16-9.

Note If a state or subchart contains messages, you cannot convert it to an atomic subchart.

Link an Atomic Subchart from a Library

To create a subcomponent for reuse across multiple charts and models, create a link from a library model. Copy a chart in a library model and paste it to a chart in another model. If the library chart contains any states, it appears as a linked atomic subchart with the label **Link** in the upper left corner.

This modeling method minimizes maintenance of similar states. When you modify the atomic subchart in the library, your changes propagate to the links in all charts and models.

If the library chart contains only functions and no states, then it appears a linked atomic box in the chart. For more information, see “Reuse Functions by Using Atomic Boxes” on page 8-28.

Convert an Atomic Subchart to a Normal Subchart

Converting an atomic subchart back to a state or a normal subchart removes all of its variable mappings. The conversion merges subchart-parented data objects with the chart-parented data to which they map.

- 1 If the atomic subchart is a library link, right-click the atomic subchart and select **Library Link > Disable Link**.
- 2 To convert an atomic subchart back to a normal subchart, right-click the atomic subchart and clear the **Group & Subchart > Atomic Subchart** check box.
- 3 To convert the subchart back to a state, right-click the subchart and clear the **Group & Subchart > Subchart** check box.
- 4 If necessary, rearrange graphical objects in your chart.

You cannot convert an atomic subchart to a normal subchart if:

- The atomic subchart maps a parameter to an expression other than a single variable name. For example, mapping a parameter `data1` to one of these expressions prevents the conversion of an atomic subchart to a normal subchart:
 - 3
 - `data2(3)`
 - `data2 + 3`
- Both of these conditions are true:
 - The atomic subchart contains MATLAB functions or truth table functions that use MATLAB as the action language.
 - The atomic subchart does not map each variable to a variable of the same name in the main chart.

When to Use Atomic Subcharts

Reuse State Logic

Suppose that you want to reuse the same state or subchart many times to facilitate large-scale modeling.

If you do not use atomic subcharts, you have to maintain each copy of a subcomponent manually. For example, this chart contains two states with a similar structure. The only difference between the two states is the names of variables. If you change the logic in state A, then you must make the same change in state B.

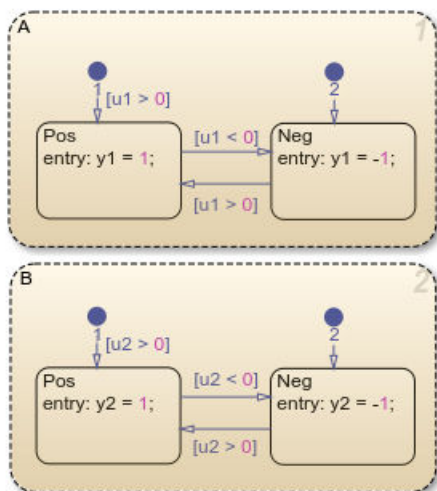

To enable reuse of subcomponents by using linked atomic subcharts, create a single copy of state A and store it as a chart in a library model. From that library, copy and paste the atomic subchart twice in your chart. Then update the mapping of subchart variables as needed.

When you change an atomic subchart in a library, the change propagates to all library links. For more information, see “Reuse a State Multiple Times in a Chart” on page 16-23.

Debug Charts Incrementally

Suppose that you want to test a sequence of changes in a chart that contains many states or several levels of hierarchy.

If you do not use atomic subcharts, when you make a small change to one part of a chart and start simulation, recompilation occurs for the entire chart. Because recompiling the entire chart can take a long time, you decide to make several changes before testing. However, if you find an error, you must step through all of your changes to identify the cause of the error.

In contrast, when you modify an atomic subchart, recompilation occurs for only the subchart and not for the entire chart. Incremental builds for simulation require less time to recompile. This reduction in compilation time enables you to test each individual change instead of waiting to test multiple changes at once. By testing each change individually, you can quickly identify a change that causes an error. For more information, see “Reduce the Compilation Time of a Chart” on page 16-29.

Develop Charts Used by Multiple People

Suppose that you want to break a chart into subcomponents because multiple people are working on different parts of the chart.

Without atomic subcharts, only one person at a time can edit the model. If someone edits one part of a chart while someone else edits another part of the same chart, you must merge those changes at submission time.

In contrast, you can store different parts of a chart as linked atomic subcharts. Because atomic subcharts behave as independent objects, different people can work on different parts of a chart without affecting the other parts of the chart. At submission time, no merge is necessary because the changes exist in separate models. For more information, see “Divide a Chart into Separate Units” on page 16-32.

Inspect Generated Code

Suppose that you want to inspect code generated by Simulink Coder or Embedded Coder manually for a specific part of a chart.

If you do not use atomic subcharts, you generate code for an entire model in one file. To find code for a specific part of the chart, you have to look through the entire file.

In contrast, you can specify that the code for an atomic subchart appears in a separate file. This method of code generation enables unit testing for a specific part of a chart. You avoid searching through unrelated code and focus only on the code that interests you. For more information, see “Generate Separate Code for an Atomic Subchart” on page 16-35.

See Also

More About

- “Encapsulate Modal Logic by Using Subcharts” on page 8-4
- “Map Variables for Atomic Subcharts and Boxes” on page 16-11
- “Model an Elevator System by Using Atomic Subcharts” on page 16-43
- “Model a Redundant Sensor Pair by Using Atomic Subcharts” on page 16-39

Rules for Using Atomic Subcharts

An atomic subchart is a graphical object that helps you to create independent subcomponents in a Stateflow chart. Atomic subcharts are supported only in Stateflow charts in Simulink models. For more information, see “Create Reusable Subcomponents by Using Atomic Subcharts” on page 16-2.

Chart Properties and Atomic Subcharts

Do Not Use Moore Charts as Atomic Subcharts

Moore charts do not have the same simulation behavior as Classic Stateflow charts with the same constructs.

Do Not Use Atomic Subcharts in Continuous-Time Charts

Continuous-time charts do not support atomic subcharts.

Avoid Using Atomic Subcharts in Charts That Execute at Initialization

You get a warning when the following conditions are true:

- The chart property **Execute (enter) Chart At Initialization** is enabled.
- The default transition path of the chart reaches an atomic subchart.

If an entry action inside the atomic subchart requires access to a chart input or data store memory, you can get inaccurate results. To avoid this warning, you can disable **Execute (enter) Chart At Initialization** or redirect the default transition path away from the atomic subchart.

For more information about execute-at-initialization behavior, see “Execution of a Chart at Initialization” on page 3-21.

Use Consistent Settings for Super Step Semantics

When you use linked atomic subcharts, verify that your settings for super step semantics match the settings in the main chart. For more information, see “Super Step Semantics” on page 3-45.

Data in Atomic Subcharts

Define Data in an Atomic Subchart Explicitly

Be sure to define data that appears in an atomic subchart explicitly in the main chart. Atomic subcharts can only access main chart data whose size, type, and complexity are fully specified. For more information, see “Set Data Properties” on page 9-5.

Map Variables of Linked Atomic Subcharts

When you use linked atomic subcharts, map the variables so that data in the subchart corresponds to the correct data in the main chart. Map subchart variables manually if, when you add the subchart, the variables do not have the same names as the corresponding symbols in the main chart. For more information, see “Map Variables for Atomic Subcharts and Boxes” on page 16-11.

Match Size, Type, and Complexity of Variables in Linked Atomic Subcharts

Verify that the size, type, and complexity of variables in a subchart match the settings of the corresponding variables in the main chart. For more information, see “Map Variables for Atomic Subcharts and Boxes” on page 16-11.

Do Not Use Variable-Size Data in Atomic Subcharts

Atomic subcharts do not support variable-sized arrays. If you select the **Variable Size** property of a subchart data object, an error occurs when you try to update the diagram or simulate the model.

Do Not Change the First Index of Local Data to a Nonzero Value

When a data store memory in an atomic subchart maps to chart-level local data, the **First index** property of the local data must remain zero. If you change **First index** to a nonzero value, an error occurs when you try to update the diagram or simulate the model.

Do Not Log Signals from Atomic Subcharts That Map Variables with Different Scopes

If an atomic subchart maps variables to variables at the main chart level with a different scope, you cannot log signals for the chart.

Restrict Use of Machine-Parented Data

If your chart contains atomic subcharts, do not use machine-parented data with the following properties:

- Imported or exported
- Is 2-D or higher, or uses fixed-point type

Machine-parented data with these properties prevent reuse of generated code and other code optimizations.

Avoid Using the Names of Subsystem Parameters in Atomic Subcharts

If a parameter in an atomic subchart matches the name of a Simulink built-in subsystem parameter, the only mapping allowed for that parameter is `Inherited`. Specifying any other parameter mapping in the **Mappings** tab of the properties dialog box causes an error. You can, however, change the parameter value at the MATLAB prompt so that all instances of that parameter have the same value.

To get a list of Simulink subsystem parameters, enter:

```
param_list = sort(fieldnames(get_param('built-in/subsystem', 'ObjectParameters')));
```

Events in Atomic Subcharts

Do Not Mix Edge-Triggered and Function-Call Input Events in The Same Atomic Subchart

Input events in an atomic subchart must all use edge-triggered type, or they must all use function-call type. This restriction is consistent with the behavior for the container chart. For more information, see “Best Practices for Using Events in Stateflow Charts” on page 11-4.

Do Not Use Outgoing Transitions When an Atomic Subchart Uses Top-level Local Events

You cannot use outgoing transitions from an atomic subchart that uses local events at the top level of the subchart. Using this configuration causes a simulation error.

Match the Trigger Type When Mapping Input Events

Each input event in an atomic subchart must map to an input event of the same trigger type in the container chart.

Do Not Map Multiple Input Events in an Atomic Subchart to the Same Input Event in the Container Chart

Each input event in an atomic subchart must map to a unique input event in the container chart. You can verify unique mappings of input events by opening the properties dialog box for the atomic subchart and checking the **Input Event Mapping** section of the **Mappings** tab.

Functions and Atomic Subcharts

Export Chart-Level Functions If Called from an Atomic Subchart

If your atomic subchart contains a function call to a chart-level function, export that function by selecting **Export Chart Level Functions**. Do not export graphical functions from an atomic subchart that maps variables to variables at the main chart level with a different scope. For more information, see “Export Stateflow Functions for Reuse” on page 8-17.

Restrictions for Converting to Atomic Subcharts

Supertransitions

The state or subchart that you want to convert to an atomic subchart cannot have any supertransitions crossing the boundary.

Data, Graphical Functions, and Events

To convert a state or subchart to an atomic subchart, access to objects not parented by the state or subchart must be one of the following:

- Chart-level data
- Chart-level graphical functions
- Input events

If the state or subchart accesses a chart-level graphical function, the chart must export that function. For more information, see “Export Stateflow Functions for Reuse” on page 8-17.

Do not export graphical functions from an atomic subchart that maps variables to variables at the main chart level with a different scope.

Local Data with a Nonzero First Index

The state or subchart that you want to convert to an atomic subchart cannot access local data where the **First index** property is nonzero. For the conversion process to work, the **First index** property of the local data must be zero, which is the default value.

Machine-Parented Data

The state or subchart that you want to convert to an atomic subchart cannot reside in a chart that uses machine-parented data with the following properties:

- Imported or exported
- Is 2-D or higher, or uses a fixed-point type

Machine-parented data with these properties prevent reuse of generated code and other code optimizations.

Strong Data Typing with Simulink Inputs and Outputs

To convert a state or subchart to an atomic subchart, your chart must use strong data typing with Simulink inputs and outputs. For more information, see “Use Strong Data Typing with Simulink I/O” on page 25-4.

Event Broadcasts

The state or subchart that you want to convert to an atomic subchart cannot refer to:

- Local events that are outside the scope of that state or subchart
- Output events

The state or subchart you want to convert can refer to *input* events.

Masked Library Chart

You cannot use a masked library chart containing mask parameters as an atomic subchart.

See Also

More About

- “Create Reusable Subcomponents by Using Atomic Subcharts” on page 16-2
- “Model an Elevator System by Using Atomic Subcharts” on page 16-43
- “Model a Redundant Sensor Pair by Using Atomic Subcharts” on page 16-39

Map Variables for Atomic Subcharts and Boxes

An atomic subchart is a graphical object that helps you create reusable subcomponents in a Stateflow chart. An atomic box is a graphical object that helps you share graphical, truth table, MATLAB, and Simulink functions across several charts. Atomic subcharts and boxes are supported only in Stateflow charts in Simulink models. For more information, see “Create Reusable Subcomponents by Using Atomic Subcharts” on page 16-2 and “Reuse Functions by Using Atomic Boxes” on page 8-28.

To ensure that each symbol in your atomic subchart or box accesses the correct symbol in the main chart, edit the mapping of subchart symbols. Right-click the subchart or box and select **Subchart Mappings**. In the **Mappings** tab of the properties dialog box, use the **Main chart symbol** drop-down list to specify which symbol in the main chart corresponds to each symbol in the subchart. Alternatively, you can type an expression specifying:

- A field of a Stateflow structure. See “Index and Assign Values to Stateflow Structures” on page 26-7.
- An element of a vector or matrix. See “Supported Operations for Vectors and Matrices” on page 18-4.
- Any valid combination of structure fields or matrix indices, such as `struct.field(1,2)` or `struct.field[0][1]`.

If you leave the **Main chart symbol** field empty, then Stateflow attempts to map the atomic subchart symbol to a main chart symbol with the same name.

You can map a symbol in the atomic subchart to a symbol in the main chart that has a different scope. This table lists the possible mappings.

Atomic Subchart Symbol Scope	Main Chart Symbol Scope
Input	Input, Output, Local, Parameter
Output	Output, Local
Parameter	Parameter
Data Store Memory	Data Store Memory, Local
Input Event	Input Event

When you map data store memory in an atomic subchart to local data of enumerated type, you have two options for specifying the initial value of the data store memory:

- In the Data properties dialog box, set the **Initial value** field for the chart-level local data.
- To apply the default value of the enumerated type, leave the **Initial value** field empty.

Map Input and Output Data for an Atomic Subchart

This model contains two Sine Wave blocks that supply input signals to a chart.

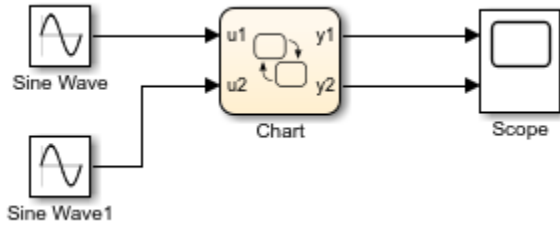

The chart consists of two linked atomic subcharts from the same library.



Both atomic subcharts contain saturator logic to convert an input sine wave to an output square wave of the same frequency.

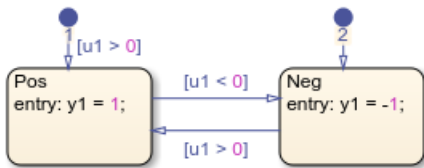

If you simulate the model, the output for y2 is zero.

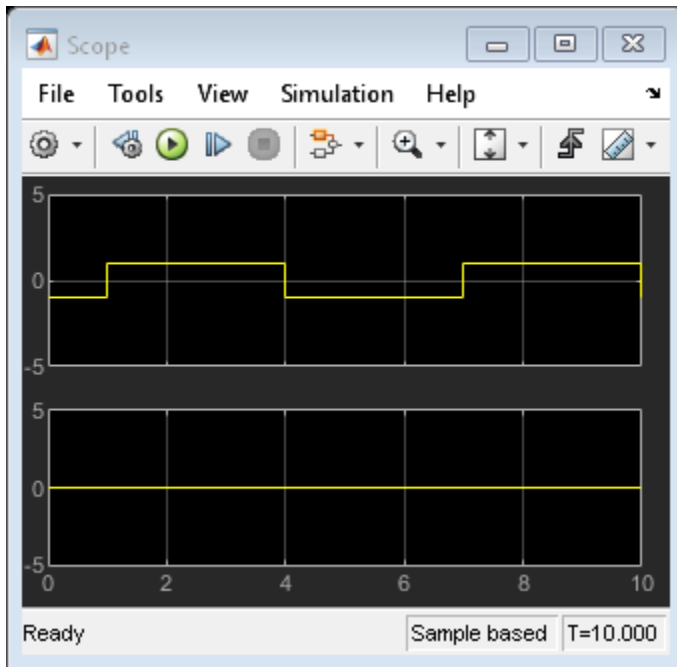

Because the symbols in atomic subchart A have the same name as the symbols $u1$ and $y1$ in the main chart, they map to the correct variables. The symbols in atomic subchart B do not map to $u2$ and $y2$ in the main chart, so you must edit the mapping.

- 1 Right-click subchart B and select **Subchart Mappings**.
- 2 Under **Input Mapping**, specify the main chart symbol for $u1$ to be $u2$.
- 3 Under **Output Mapping**, specify the main chart symbol for $y1$ to be $y2$.
- 4 Click **OK**.

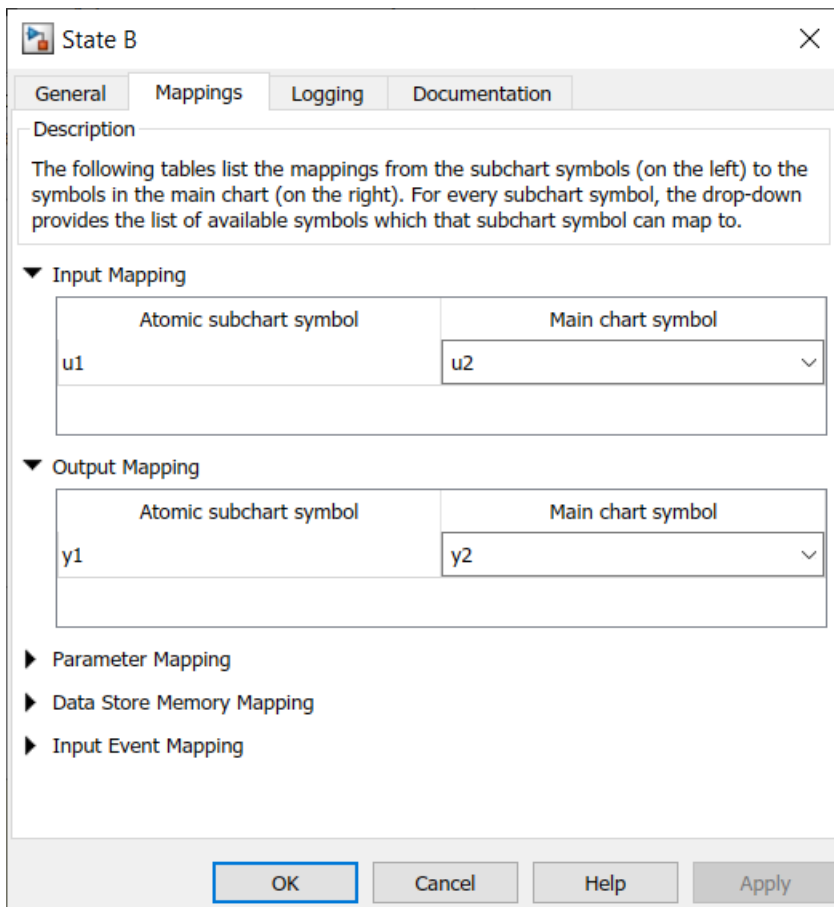

When you run the model again, you get these results.

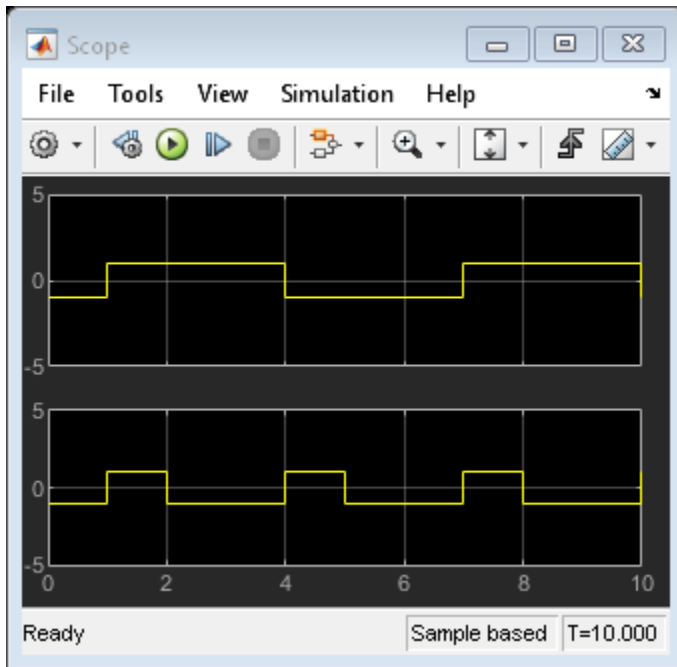

Map Atomic Subchart Variables to Bus Elements

This model contains two Sine Wave blocks that supply signals through a bus to a chart.

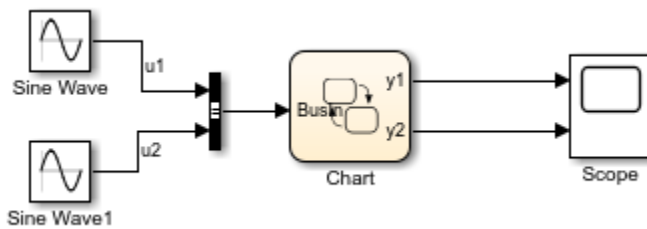

The chart consists of two linked atomic subcharts from the same library. Both atomic subcharts contain saturator logic to convert an input sine wave to an output square wave of the same frequency.

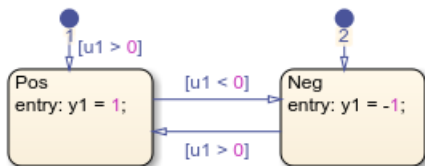

If you simulate the model, you get an error because the u1 inputs in each subchart do not map to any variables in the main chart. To edit the mapping for u1 in each subchart:

- 1 Right-click subchart A and select **Subchart Mappings**.
- 2 Under **Input Mapping**, specify the main chart symbol for u1 to be the first element in the bus: BusIn.u1.

- 3 Click **OK**.
- 4 Repeat for subchart B, specifying the main chart symbol for u1 to be the second element in the bus: BusIn.u2.

When you run the model again, you get these results.

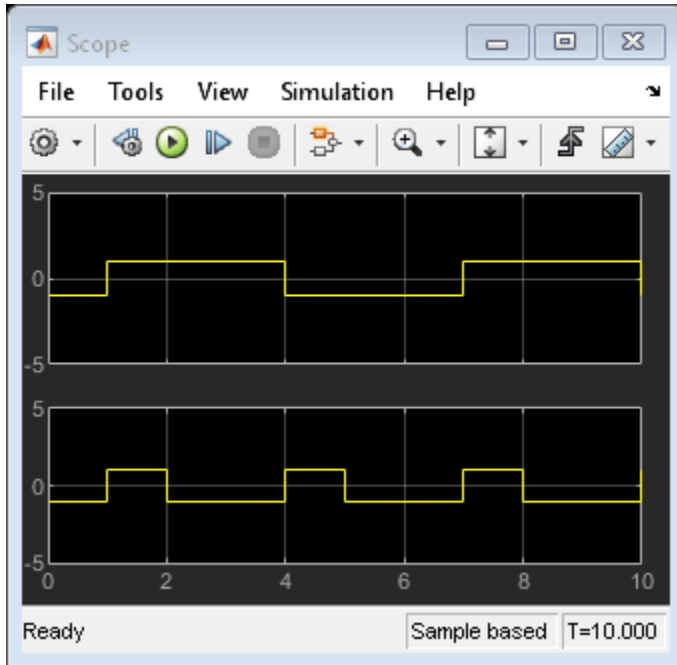

Map Atomic Subchart Variables to the Elements of a Matrix

When referring to elements of a vector or matrix, regardless of the action language of the chart, use:

- One-based indexing delimited by parentheses and commas. For example, $A(4, 5)$.
- Zero-based indexing delimited by brackets. For example, $A[3][4]$.

Indices can be numbers or parameters in the chart. The use of other expressions as indices is not supported.

For example, this model contains two Sine Wave blocks that supply signals through a diagonal matrix to a chart.

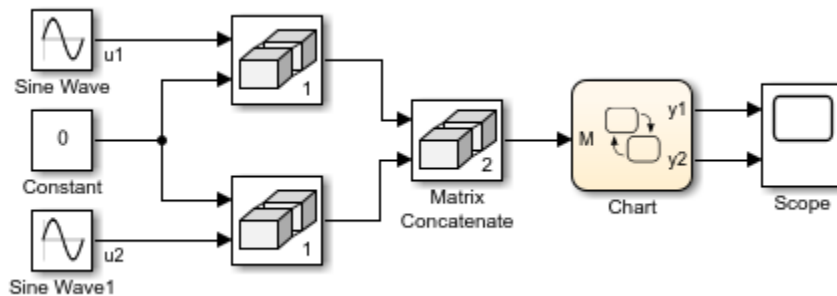

The chart consists of two linked atomic subcharts from the same library. Both atomic subcharts contain saturator logic to convert an input sine wave to an output square wave of the same frequency.

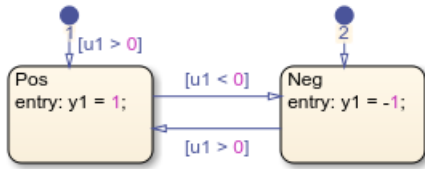

If you simulate the model, you get an error because the `u1` inputs in each subchart do not map to any variables in the main chart. To edit the mapping for `u1` in each subchart:

- 1 Right-click subchart A and select **Subchart Mappings**.
- 2 Under **Input Mapping**, specify the main chart symbol for `u1` to be the top-left element in the matrix. The zero-based indexing format for this element is `M[0][0]`.
- 3 Click **OK**.
- 4 Repeat for subchart B, specifying the main chart symbol for `u1` to be the bottom-right element in the matrix. The one-based indexing format for this element is `M(2,2)`.

When you run the model again, you get these results.

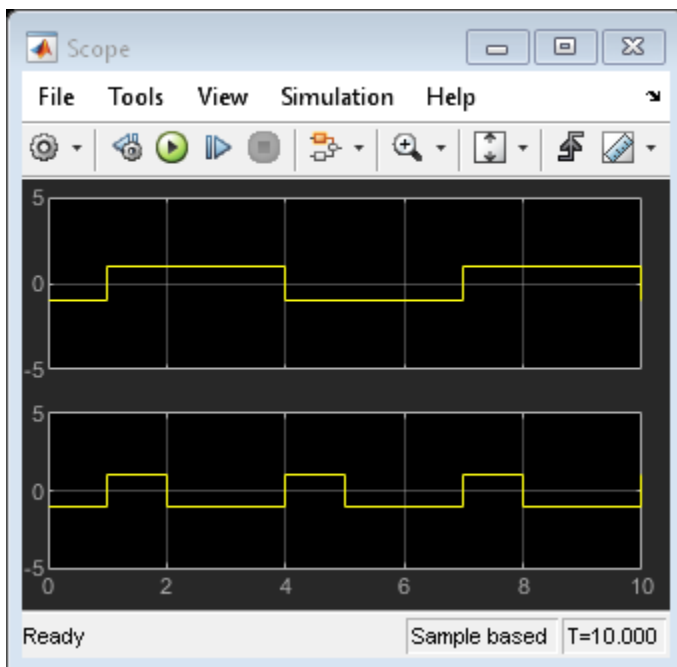

Map Atomic Subchart Parameters to Expressions

For parameters in an atomic subchart, you can specify a constant expression or an expression that depends on one or more parameters in the main chart.

For example, this model contains two Sine Wave blocks that supply input signals to a chart.

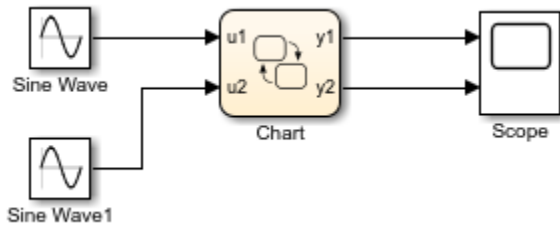

The chart consists of two linked atomic subchart from the same library. Both atomic subcharts contain saturator logic to convert an input sine wave to an output square wave of the same frequency.

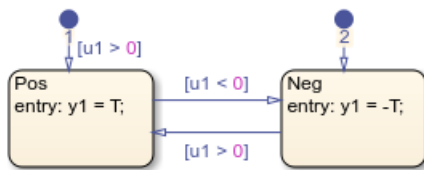

If you simulate the model, you get an error because the parameter T is undefined. To fix this error, specify an expression for T to evaluate in the main chart:

- 1 Right-click subchart A and select **Subchart Mappings**.
- 2 Under **Parameter Mapping**, as the value for T, enter -1.
- 3 Click **OK**.
- 4 Repeat for subchart B, specifying the value of T as 2.

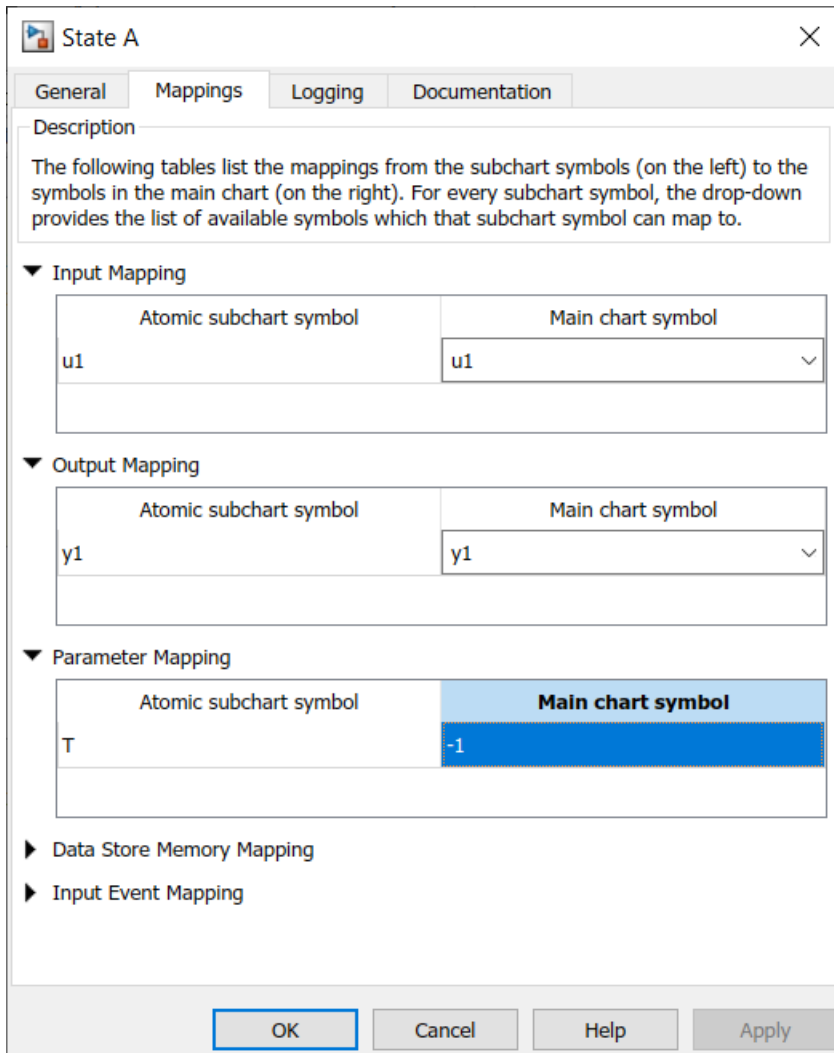

When you run the model again, you get these results.

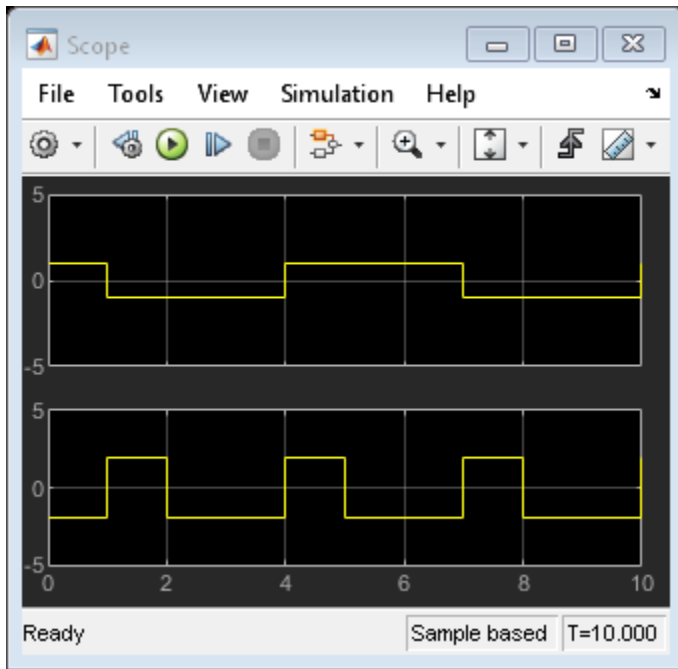

Map Input Events for an Atomic Subchart

This model contains a Mux block that supplies input events to a chart.

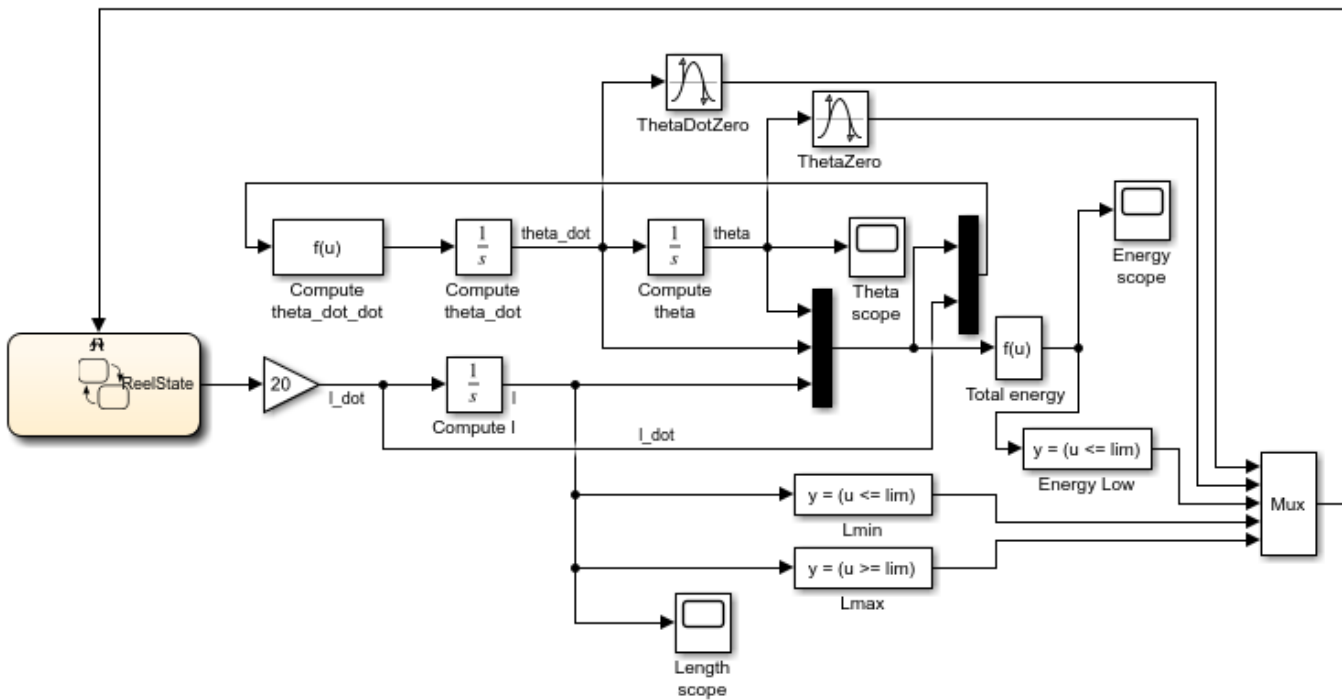

The chart contains two superstates: Active and Inactive. The Active state uses input events to guard transitions between different substates.

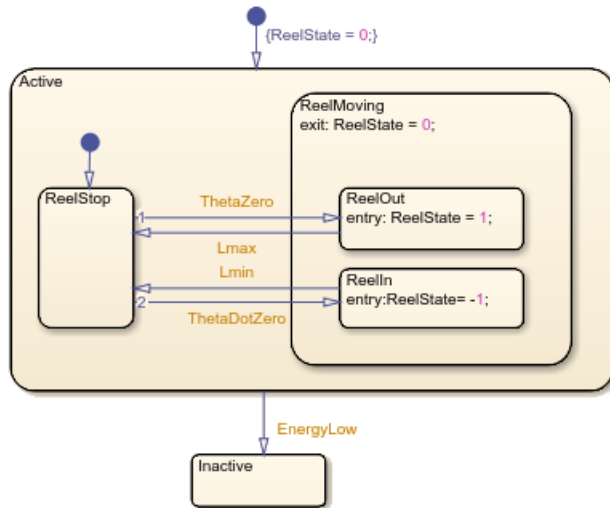

To convert the Active state to an atomic subchart:

- 1 Right-click the Active state and select **Group & Subchart > Atomic Subchart**.
- 2 Right-click the atomic subchart and select **Subchart Mappings**.
- 3 Under **Input Event Mapping**, map each atomic subchart symbol to the corresponding input event in the main chart.
- 4 Click **OK**.

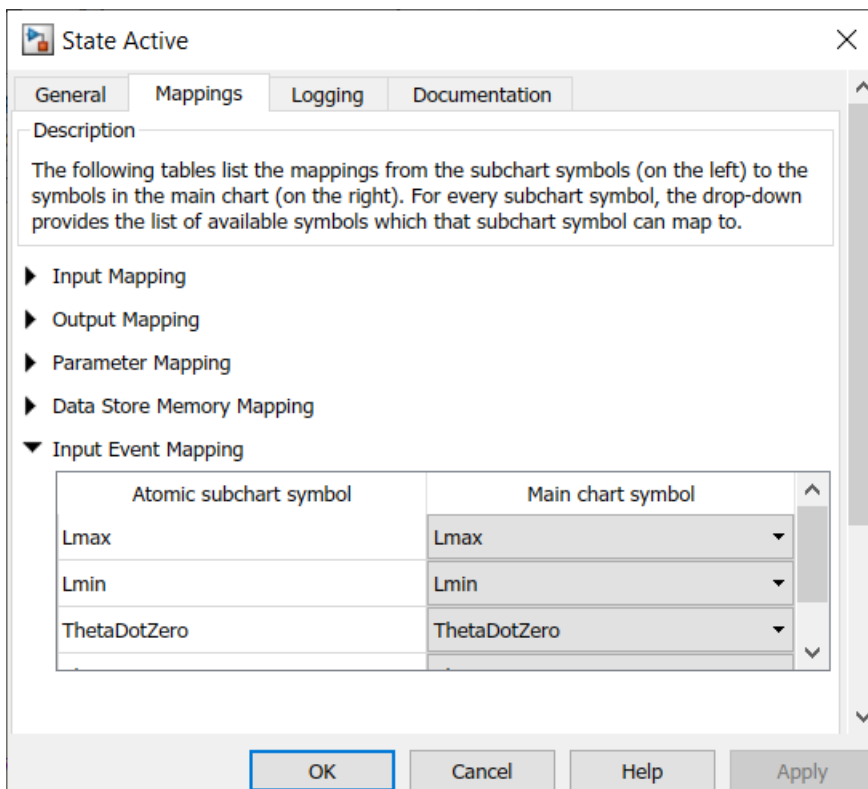

Disable Input Events for Atomic Subcharts

Not every input event in an atomic subchart has to correspond to an event in the main chart. For example, you can create a linked atomic subchart that does not use the entire set of events that are defined in the library chart. To disable an input event in an atomic subchart:

- 1 Right-click the atomic subchart and select **Subchart Mappings**.
- 2 Under **Input Event Mapping**, in the **Main chart symbol** drop-down list, select `<disabled>`.
- 3 Click **OK**.

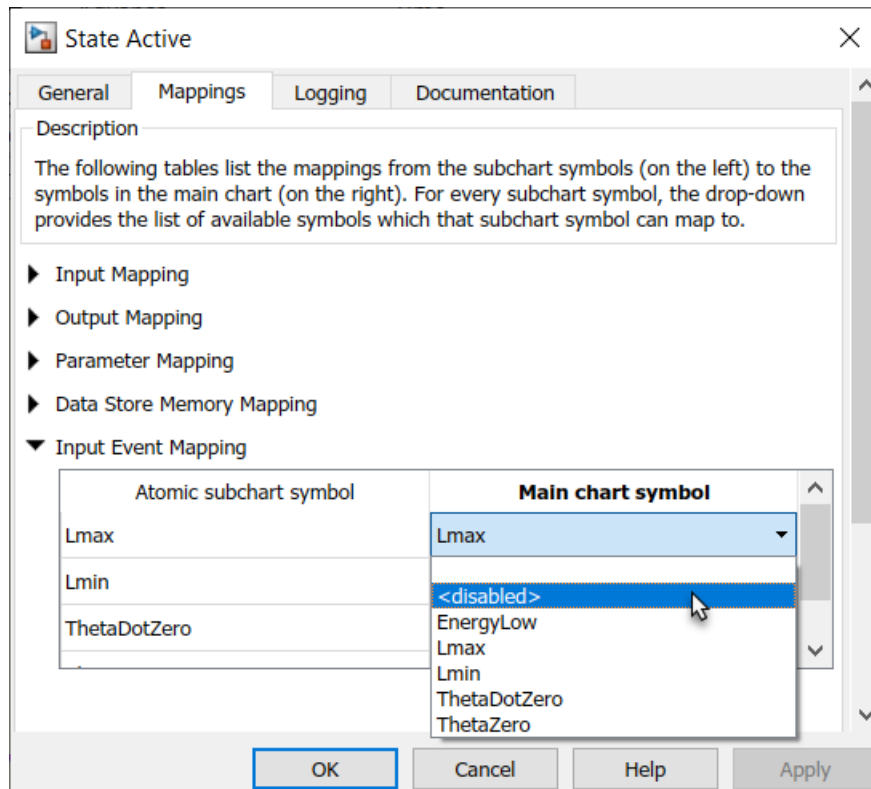

See Also

More About

- “Create Reusable Subcomponents by Using Atomic Subcharts” on page 16-2
- “Reuse Functions by Using Atomic Boxes” on page 8-28
- “Index and Assign Values to Stateflow Structures” on page 26-7
- “Supported Operations for Vectors and Matrices” on page 18-4

Reuse a State Multiple Times in a Chart

This example shows how to use linked atomic subcharts to repeat the same configuration of states and transitions multiple times in a Stateflow® chart. Atomic subcharts are supported only in Stateflow charts in Simulink® models. For more information, see “Create Reusable Subcomponents by Using Atomic Subcharts” on page 16-2.

Original Model Without Atomic Subcharts

This model contains two Sine Wave blocks: one with a frequency of 1 radian per second, and the other with a frequency of 2 radians per second.

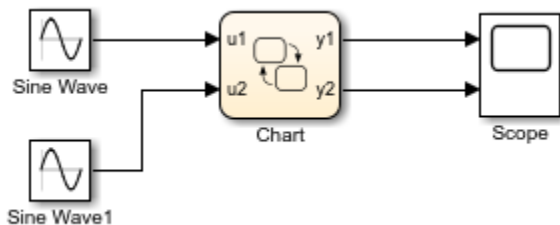

In the chart, each state uses saturator logic to convert the input sine wave to an output square wave of the same frequency. The states perform the same actions and differ only in the names of their input and output data.

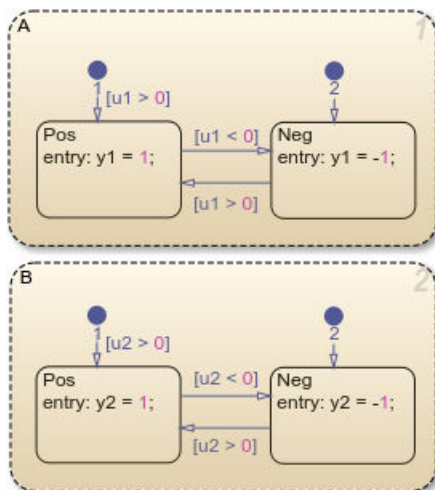

Simulating the model produces these results.

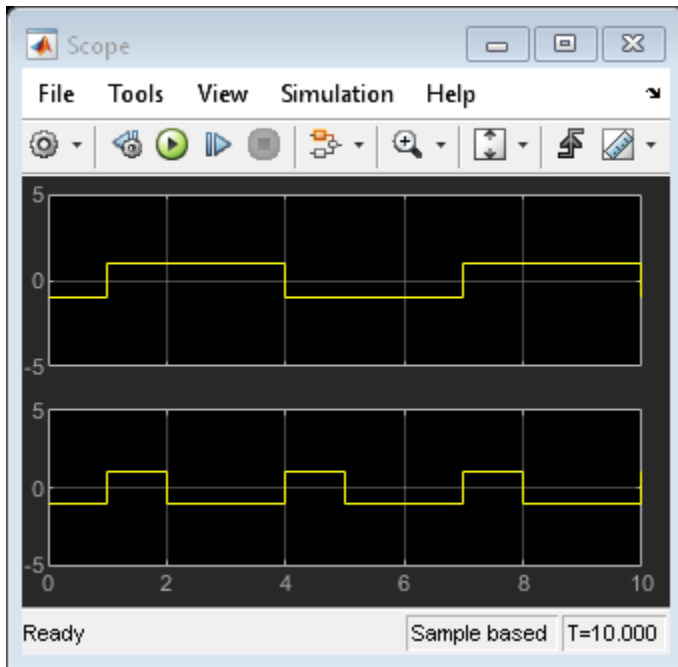

Because this example does not use atomic subcharts, you have to maintain each subcomponent manually. For example, if you change the logic in state A, then you must make the same change in state B.

In contrast, if you replace the states in this example with atomic subcharts, you can reuse the same object in your model and retain the same simulation results. You can save state A as an atomic subchart in a library model and then use multiple linked instances of that subchart in your chart. Changes in the library model propagate to all linked instances of the subchart.

Edit Model to Use Atomic Subcharts

Step 1: Convert a State to an Atomic Subchart

Right-click state A and select **Group & Subchart > Atomic Subchart**. State A changes to an atomic subchart and displays the label **Atomic** in the upper-left corner.

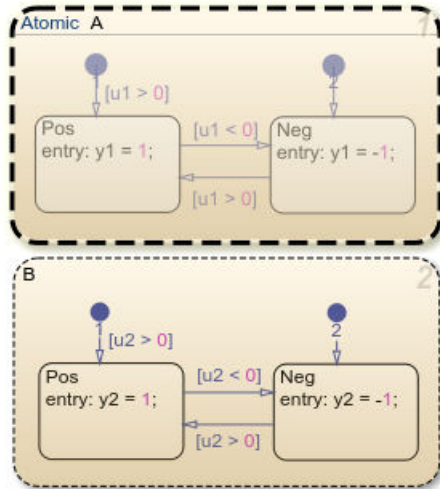

Step 2: Create a Library for the Atomic Subchart

- 1 Create a new library model.
- 2 Copy the atomic subchart and paste it in your library model.
- 3 Save your library model.

In the library model, the atomic subchart appears as an independent chart with an input port and an output port.

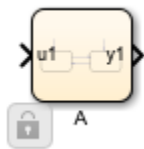

Step 3: Replace States with Linked Atomic Subcharts

- 1 Delete both states in the chart.
- 2 Copy the atomic subchart in your library and paste it in your chart twice.
- 3 Change the name of the second atomic subchart to B.

Each linked atomic subchart appears opaque and contains the label **Link** in the upper-left corner.

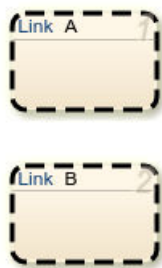

Step 4: Edit the Mapping of Input and Output Variables

If you simulate the model now, the output for y_2 is zero. You also see warnings about unused data. These warnings appear because atomic subchart B uses u_1 and y_1 instead of u_2 and y_2 .

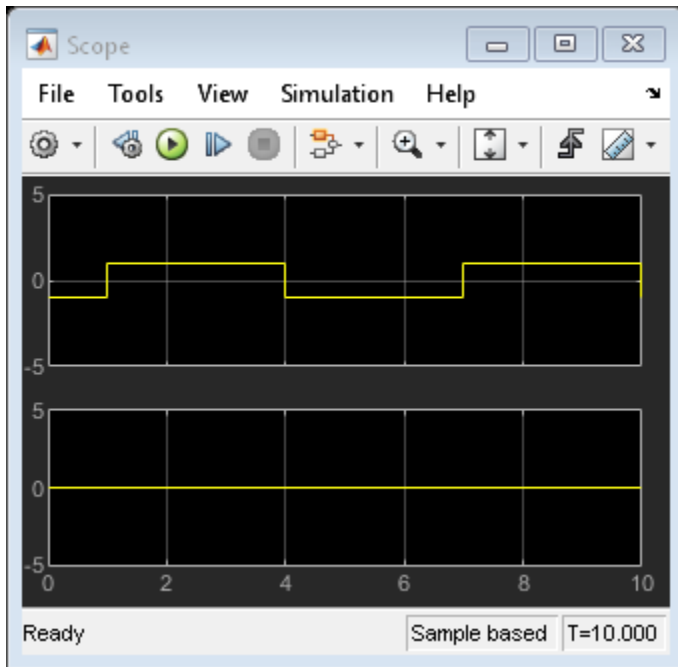

To fix these warnings, you must edit the mapping of input and output variables.

- 1 Right-click subchart B and select **Subchart Mappings**.
- 2 Under **Input Mapping**, specify the main chart symbol for u_1 to be u_2 .
- 3 Under **Output Mapping**, specify the main chart symbol for y_1 to be y_2 .
- 4 Click **OK**.

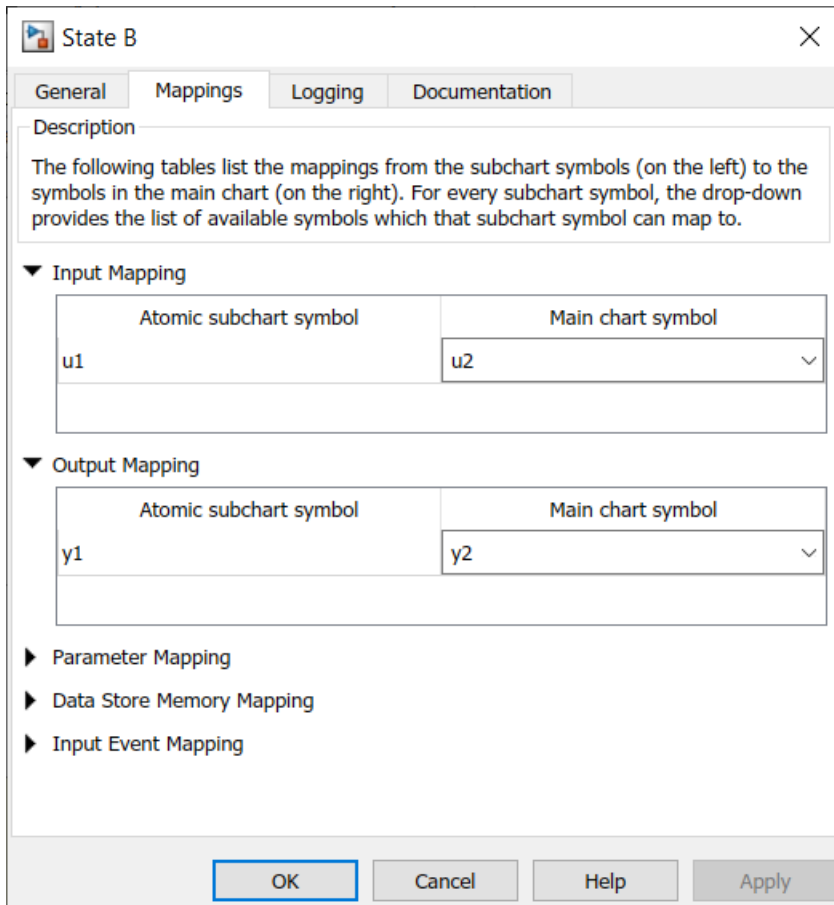

Run the New Model

When you simulate the new model, the results match those of the original design.

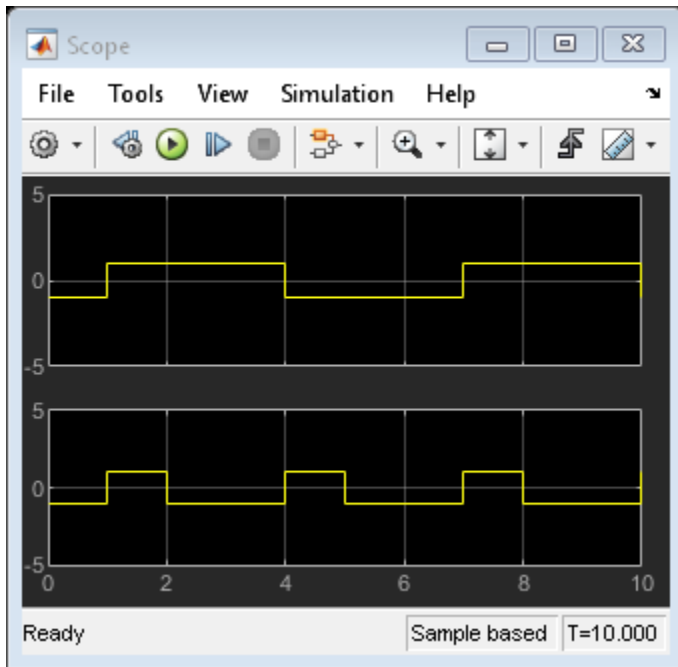

Propagate a Change in the Library Chart

Suppose that, in the library chart, you edit the transition from Pos to Neg.

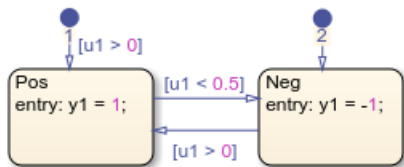

This change propagates to all linked atomic subcharts in your main chart. You do not have to update each state individually.

See Also

Sine Wave

More About

- “Create Reusable Subcomponents by Using Atomic Subcharts” on page 16-2
- “Map Variables for Atomic Subcharts and Boxes” on page 16-11
- “Model an Elevator System by Using Atomic Subcharts” on page 16-43
- “Model a Redundant Sensor Pair by Using Atomic Subcharts” on page 16-39

Reduce the Compilation Time of a Chart

This example shows how to use atomic subcharts to reduce the compilation time when testing a sequence of changes in a Stateflow® chart. Atomic subcharts are supported only in Stateflow charts in Simulink® models. For more information, see “Create Reusable Subcomponents by Using Atomic Subcharts” on page 16-2.

Original Model Without Atomic Subcharts

This model contains two Sine Wave blocks: one with a frequency of 1 radian per second, and the other with a frequency of 2 radians per second.

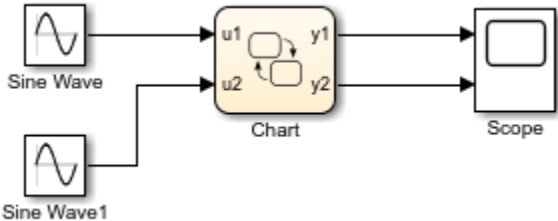

In the chart, each state uses saturator logic to convert the input sine wave to an output square wave of the same frequency.

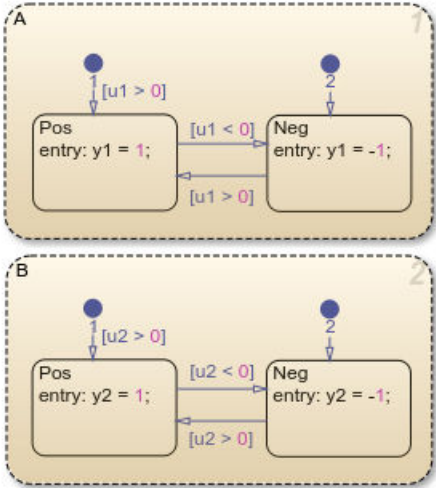

Because this example does not use atomic subcharts, every time that you make a change to the chart and start simulation, recompilation occurs for the entire chart.

In contrast, you can convert state A to an atomic subchart. When you modify the atomic subchart, recompilation occurs for only the subchart and not for the entire chart. As a result, incremental builds for simulation require less time to recompile.

Edit Model to Use Atomic Subcharts

Step 1: Convert a State to an Atomic Subchart

Right-click state A and select **Group & Subchart > Atomic Subchart**. State A changes to an atomic subchart and displays the label **Atomic** in the upper-left corner.

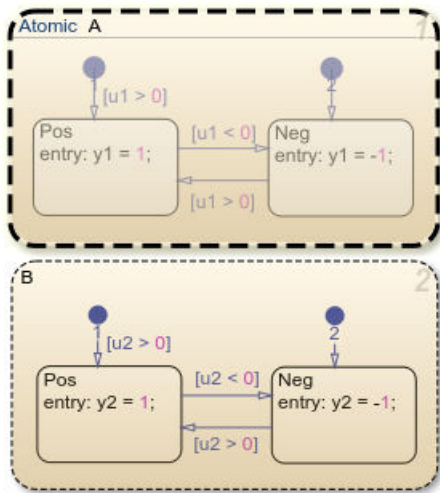

Step 2: Start the Simulation

Before simulating, compilation occurs for the entire chart.

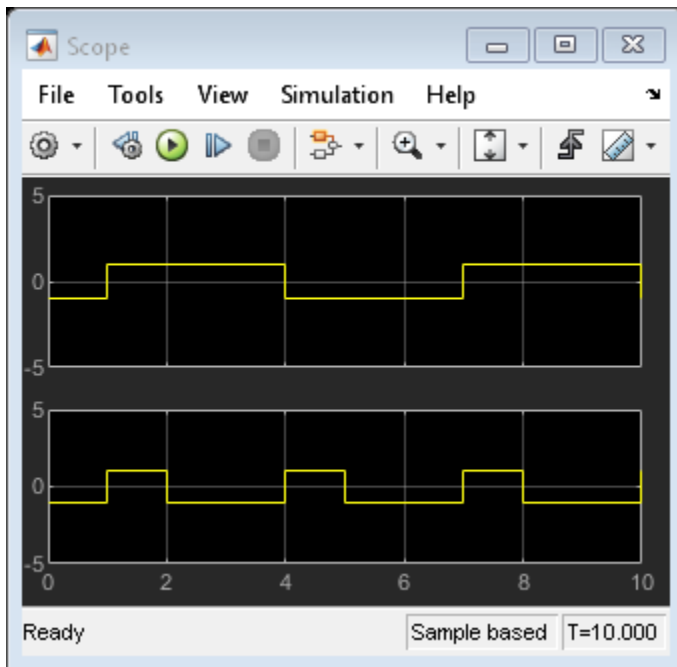

Step 3: Modify the Atomic Subchart

- 1 Double-click the atomic subchart A. The contents of the subchart appear in the Stateflow Editor.
- 2 In the state Pos, change the entry action to $y1 = 2$;
- 3 In the state Neg, change the entry action to $y1 = -2$;

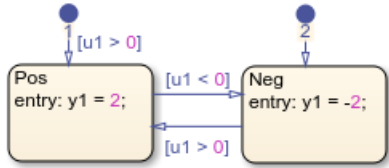

Step 4: Restart the Simulation

After the changes to A, recompilation occurs only for the atomic subchart and not the entire chart.

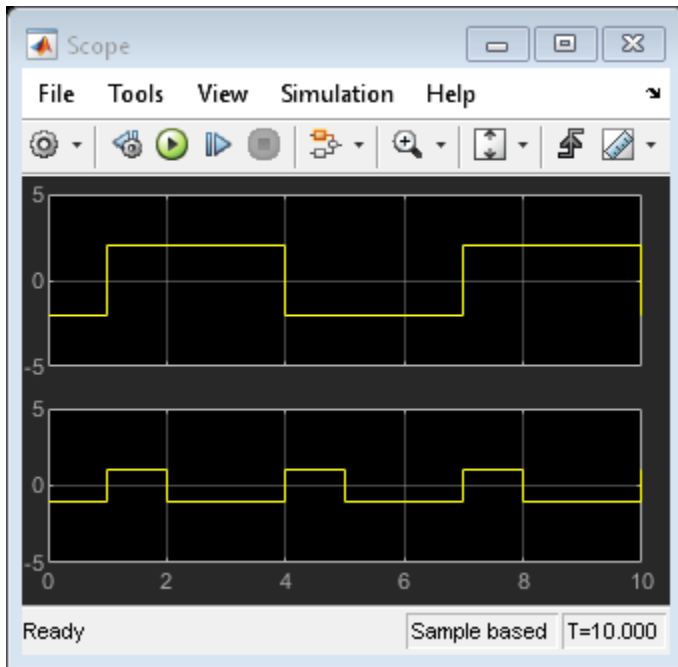

See Also

Sine Wave

More About

- “Create Reusable Subcomponents by Using Atomic Subcharts” on page 16-2
- “Reuse a State Multiple Times in a Chart” on page 16-23
- “Model an Elevator System by Using Atomic Subcharts” on page 16-43
- “Model a Redundant Sensor Pair by Using Atomic Subcharts” on page 16-39

Divide a Chart into Separate Units

This example shows how to use linked atomic subcharts to break a Stateflow® chart into subcomponents so that multiple people can work on different parts of the chart. Atomic subcharts are supported only in Stateflow charts in Simulink® models. For more information, see “Create Reusable Subcomponents by Using Atomic Subcharts” on page 16-2.

Original Model Without Atomic Subcharts

This model contains two Sine Wave blocks: one with a frequency of 1 radian per second, and the other with a frequency of 2 radians per second.

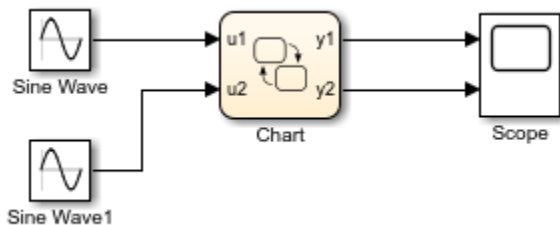

In the chart, each state uses saturator logic to convert the input sine wave to an output square wave of the same frequency.

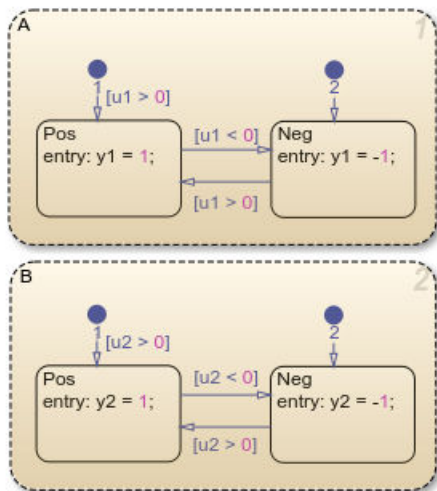

Because this example does not use atomic subcharts, only one person at a time can edit the model. If you edit state A while someone else edits state B, you must merge those changes at submission time.

In contrast, you can store different parts of this example as linked atomic subcharts. Because atomic subcharts behave as independent objects, different people can work on different parts of a chart without affecting the other parts of the chart. At submission time, no merge is necessary because the changes exist in separate models.

Edit Model to Use Atomic Subcharts

Step 1: Convert a State to an Atomic Subchart

Right-click state A and select **Group & Subchart > Atomic Subchart**. State A changes to an atomic subchart and displays the label **Atomic** in the upper-left corner.

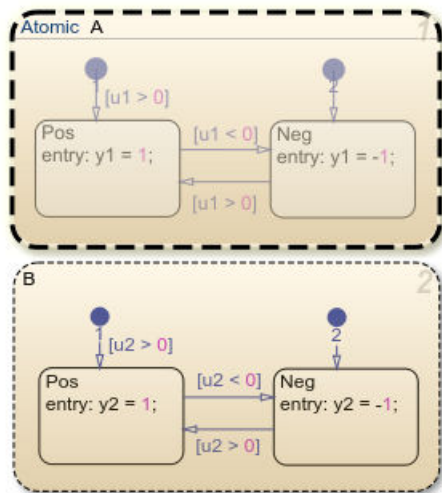

Step 2: Create a Library for the Atomic Subchart

- 1 Create a new library model.
- 2 Copy the atomic subchart and paste it in your library model.
- 3 Save your library model.

In the library model, the atomic subchart appears as an independent chart with an input port and an output port.

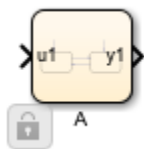

Step 3: Replace State with Linked Atomic Subchart

- 1 Delete state A in the chart.
- 2 Copy the atomic subchart in your library and paste it in your chart.

The linked atomic subchart appears opaque and contains the label **Link** in the upper-left corner.

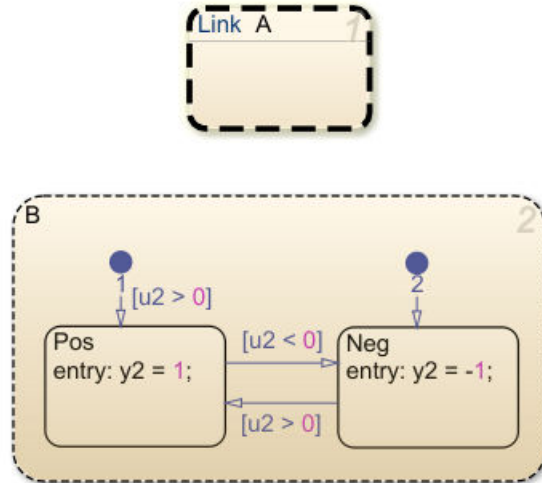

Propagate a Change in the Library Chart

Suppose that, in the library chart, you edit the transition from Pos to Neg.

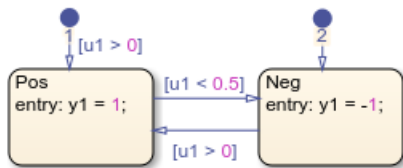

This change propagates to the linked atomic subchart in the main chart. If someone else edits the main chart, the changes are merged automatically.

See Also

Sine Wave

More About

- “Create Reusable Subcomponents by Using Atomic Subcharts” on page 16-2
- “Reuse a State Multiple Times in a Chart” on page 16-23
- “Model an Elevator System by Using Atomic Subcharts” on page 16-43
- “Model a Redundant Sensor Pair by Using Atomic Subcharts” on page 16-39

Generate Separate Code for an Atomic Subchart

This example shows how to use atomic subcharts to generate code for individual parts of a Stateflow® chart. When you generate code for your chart, a separate file stores the code for the atomic subchart. Atomic subcharts are supported only in Stateflow charts in Simulink® models. For more information, see “Create Reusable Subcomponents by Using Atomic Subcharts” on page 16-2.

Original Model Without Atomic Subcharts

This model contains two Sine Wave blocks: one with a frequency of 1 radian per second, and the other with a frequency of 2 radians per second.

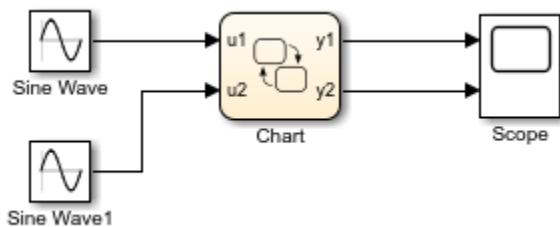

In the chart, each state uses saturator logic to convert the input sine wave to an output square wave of the same frequency.

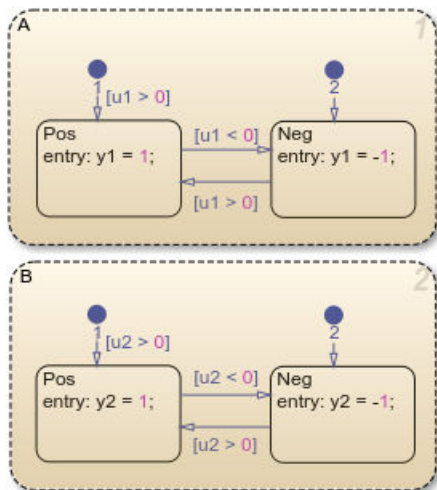

Because this example does not use atomic subcharts, generated code for the entire model is stored in one file. To find code for a specific part of the chart, you have to look through the entire file.

In contrast, you can convert state A to an atomic subchart and specify that the code for the subchart appears in a separate file. This method of code generation enables unit testing for a specific part of a chart. You avoid searching through unrelated code and focus only on the code that interests you.

Edit Model to Use Atomic Subcharts

Step 1: Convert a State to an Atomic Subchart

Right-click state A and select **Group & Subchart > Atomic Subchart**. State A changes to an atomic subchart and displays the label **Atomic** in the upper-left corner.

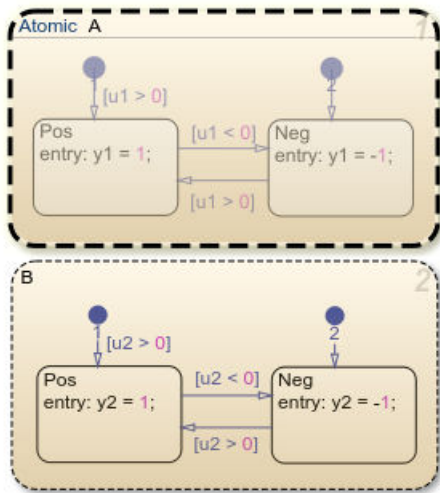

Step 2: Set Up a Standalone C File for the Atomic Subchart

- 1 Open the properties dialog box for subchart A by right-clicking the subchart and selecting **Properties**.
- 2 Set the **Code generation function packaging** property to `Reusable` function.
- 3 Set the **Code generation file name options** property to `User specified`.
- 4 In the **Code generation file name** box, enter `saturator` as the name of the file.
- 5 Click **OK**.

Step 3: Set Up the Code Generation Report

- 1 In the **Modeling** tab, click **Chart Properties > Model Settings** to open the Configuration parameters dialog box.
- 2 In the **Code Generation** tab, set the **System target file** parameter to `ert.tlc`.
- 3 Under **Code Generation > Report**, select **Create code generation report**.
- 4 Under **Advanced parameters**, select **Model-to-code**.
- 5 Click **Apply**.

Step 4: Customize the Generated Function Names

In the Configuration Parameters dialog box, in the **Code Generation > Identifiers** tab, set the **Subsystem methods** parameter to the format scheme `RNMF`, where:

- `$R` is the root model name.
- `$N` is the block name.
- `$M` is the mangle token.
- `$F` is the type of interface function for the atomic subchart.

Generate Code

To generate code for your model by using Embedded Coder®, press **Ctrl+B**.

The code generation report contains links to the code generated from the chart (**Model files**) and the atomic subchart (**Subsystem files**). To inspect the code for the subchart, click the `saturator.c` hyperlink.

The screenshot shows the 'Code Generation Report' window. On the left, there is a 'Contents' pane with links to various reports: Summary, Subsystem Report, Code Interface Report, Traceability Report, Static Code Metrics Report, Code Replacements Report, and Coder Assumptions. Below this is the 'Generated Code' section, which is expanded to show a tree view of files: Main file (ert_main.c), Model files (ex_reuse_states.c, ex_reuse_states.h, ex_reuse_states_private.h, ex_reuse_states_types.h), Subsystem files (saturator.c, saturator.h), Data files (ex_reuse_states_data.c), and Utility files (1). The main area of the window displays the C code for saturator.c, with line numbers 18 through 56. The code includes headers, defines constants, and implements a function named `ex_reuse_states_A_during`. The function signature is `void ex_reuse_states_A_during(real_T rtu_u1, real_T *rty_y1, rtDW_A_ex_reuse_states *localDW)`. The code uses conditional logic based on the state of `localDW->is_c3_ex_reuse_states` and the value of `rtu_u1` to set `*rty_y1` to 1.0, -1.0, or 0.0. The code is annotated with comments indicating the chart and transition being processed.

```

18
19 #include "saturator.h"
20
21 /* Include model header file for global data */
22 #include "ex_reuse_states.h"
23 #include "ex_reuse_states_private.h"
24
25 /* Named constants for Chart: '<S1>/A' */
26 #define ex_reuse_sta_IN_NO_ACTIVE_CHILD ((uint8_T)0U)
27 #define ex_reuse_states_IN_Neg          ((uint8_T)1U)
28 #define ex_reuse_states_IN_Pos          ((uint8_T)2U)
29
30 /* Function for Chart: '<S1>/A' */
31 void ex_reuse_states_A_during(real_T rtu_u1, real_T *rty_y1,
32     rtDW_A_ex_reuse_states *localDW)
33 {
34     /* During: Chart/A */
35     if (localDW->is_c3_ex_reuse_states == ex_reuse_states_IN_Neg) {
36         /* During 'Neg': '<S2>:9' */
37         if (rtu_u1 > 0.0) {
38             /* Transition: '<S2>:7' */
39             localDW->is_c3_ex_reuse_states = ex_reuse_states_IN_Pos;
40
41             /* Entry 'Pos': '<S2>:8' */
42             *rty_y1 = 1.0;
43         }
44     } else {
45         /* During 'Pos': '<S2>:8' */
46         if (rtu_u1 < 0.0) {
47             /* Transition: '<S2>:6' */
48             localDW->is_c3_ex_reuse_states = ex_reuse_states_IN_Neg;
49
50             /* Entry 'Neg': '<S2>:9' */
51             *rty_y1 = -1.0;
52         }
53     }
54 }
55
56 /* Function for Chart: '<S1>/A' */

```

At the bottom right of the window, there are 'OK' and 'Help' buttons.

Line 31 shows that the during function generated for the atomic subchart has the name `ex_reuse_states_A_during`. This name follows the format scheme `RNMF` specified for Subsystem methods:

- The root model name is `ex_reuse_states`.
- The block name is `A`.
- The mangle token is empty.
- The type of interface function for the atomic subchart is `during`.

Note: The line numbers that appear in your code generation report can differ from the numbers shown.

See Also

Sine Wave

More About

- “Create Reusable Subcomponents by Using Atomic Subcharts” on page 16-2
- “Reuse a State Multiple Times in a Chart” on page 16-23
- “Generate Code from Atomic Subcharts” on page 32-14

Model a Redundant Sensor Pair by Using Atomic Subcharts

This model shows how to model a redundant pair of sensors. By using atomic subcharts, you can compose a large Stateflow® chart from other charts that reside in a library file.

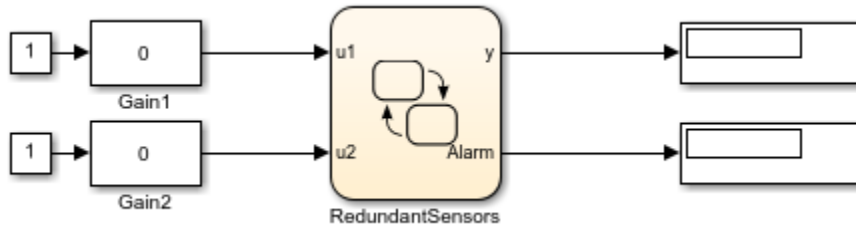

Main Chart

In this model, the chart RedundantSensors contains two linked atomic subcharts (Sensor1 and Sensor2) and a state (Alarm).

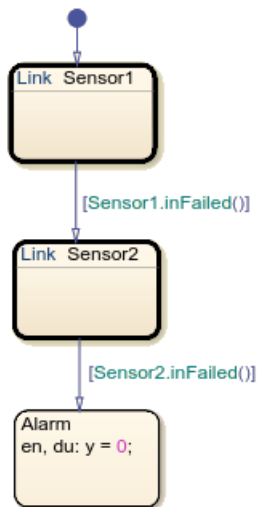

At the start of the simulation, the subchart **Sensor1** is active. This atomic subchart reads the input **u1**. If the input value remains between 75 and -75, **Sensor1** passes this value as the output of **y**. Otherwise, the sensor fails and subchart **Sensor2** becomes active.

In a similar way, **Sensor2** reads the input **u2** and checks that its value remains between 100 and -100. **Sensor2** passes this value as the output of **y**. Otherwise, the sensor fails and the chart transitions to the **Alarm** state.

Library Chart

The logic for both **Sensor1** and **Sensor2** is defined in a library model. In this model, the chart **SingleSensor** accepts an input **u** and provides a filtered sensor output **y**.

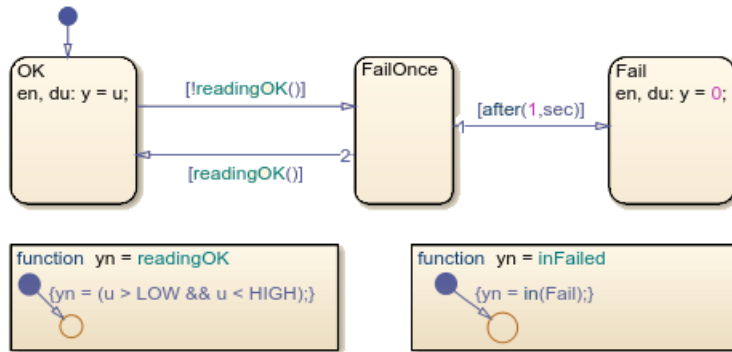

The chart detects out-of-range errors in the sensor input u . Initially, the sensor is in the state `OK`. If u goes out of range, the chart takes the transition from `OK` to the state `FailOnce`. If u stays out of range for longer than one second, then the chart transitions to the state `Fail`. In this case, the sensor outputs a constant value of zero. This pattern allows the sensor to ignore transient spikes in the sensor reading.

Map Inputs, Outputs, and Parameters

The chart `RedundantSensors` has two inputs ($u1$ and $u2$), while the library chart that defines the atomic subcharts has only one input (u). To enable the atomic subcharts to access a different chart input, right-click each subchart and select **Subchart Mappings**. In the **Mappings** tab of the properties dialog box, you can:

- Specify which symbol in the main chart corresponds to each symbol in the subchart.
- Assign values to parameters defined in the subchart.

For example, in the case of subchart `Sensor1`:

- The subchart input u is mapped to the main chart input $u1$.
- The subchart output u is mapped to the main chart output y .
- The subchart parameters `HIGH` and `LOW` are assigned the values 75 and -75.

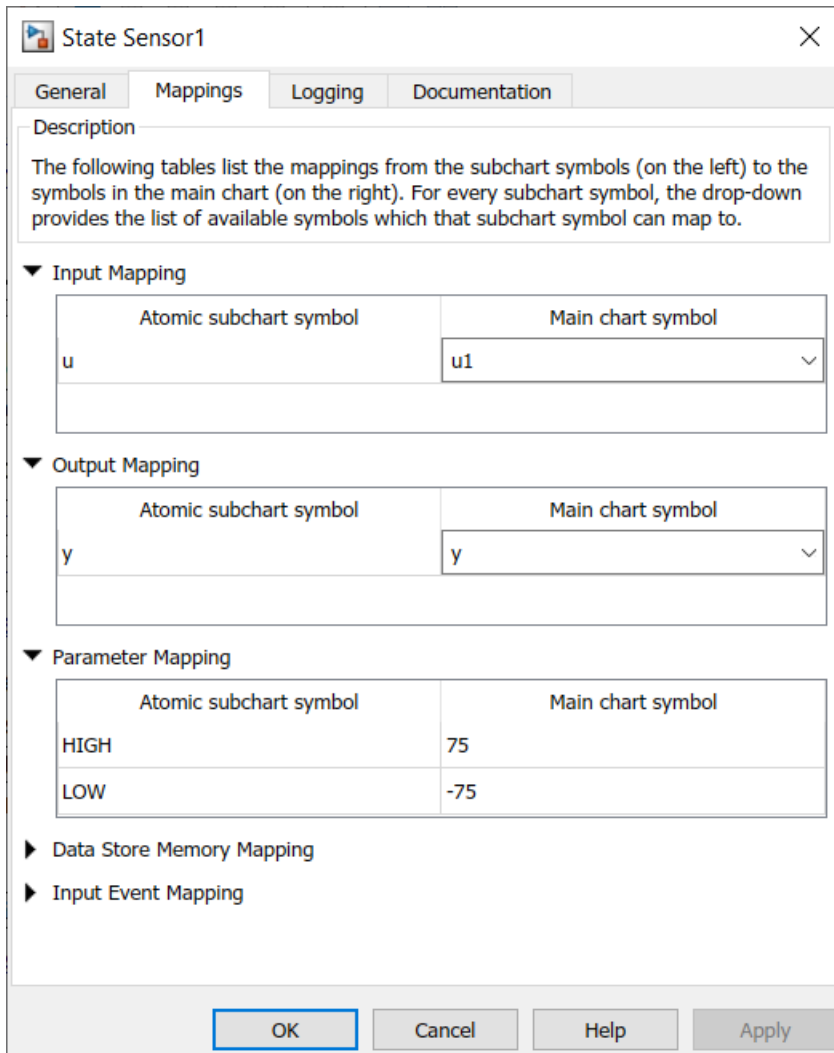

In the case of subchart Sensor2:

- The subchart input *u* is mapped to the main chart input *u2*.
- The subchart output *u* is mapped to the main chart output *y*.
- The subchart parameters *HIGH* and *LOW* are assigned the values 100 and -100.

Simulation Behavior

Initially, both inputs and both outputs to the chart are zero. To change the value of the chart inputs, double-click the Gain blocks and drag the slider.

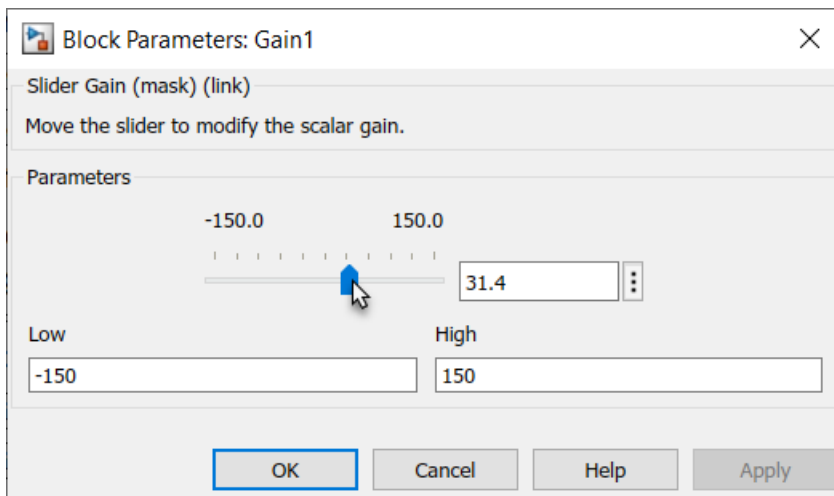

As long as the value of $u1$ is between -75 and 75 , the output value y tracks the input value $u1$. If the value of $u1$ exceeds these bounds, the value of y begins to track the input value $u2$. If the value of $u2$ falls outside the range from -100 to 100 , y returns a value of zero and $Alarm$ returns a value of one.

See Also

More About

- “Create Reusable Subcomponents by Using Atomic Subcharts” on page 16-2
- “Map Variables for Atomic Subcharts and Boxes” on page 16-11
- “Reuse Logic Patterns by Defining Graphical Functions” on page 8-13

Model an Elevator System by Using Atomic Subcharts

This example shows how to model a two-car elevator system by using linked atomic subcharts in Stateflow®. The elevator system consists of a Simulink® model and a user interface (UI). The model contains two Stateflow charts:

- Elevator System models the core logic that delegates incoming requests from the UI to the nearest available elevator car. This chart contains a pair of atomic subcharts that implement identical logic for the cars.
- UI Controller processes information from the Elevator System chart and updates the UI display. In this chart, each atomic subchart determines when to move an elevator car and when to open its doors.

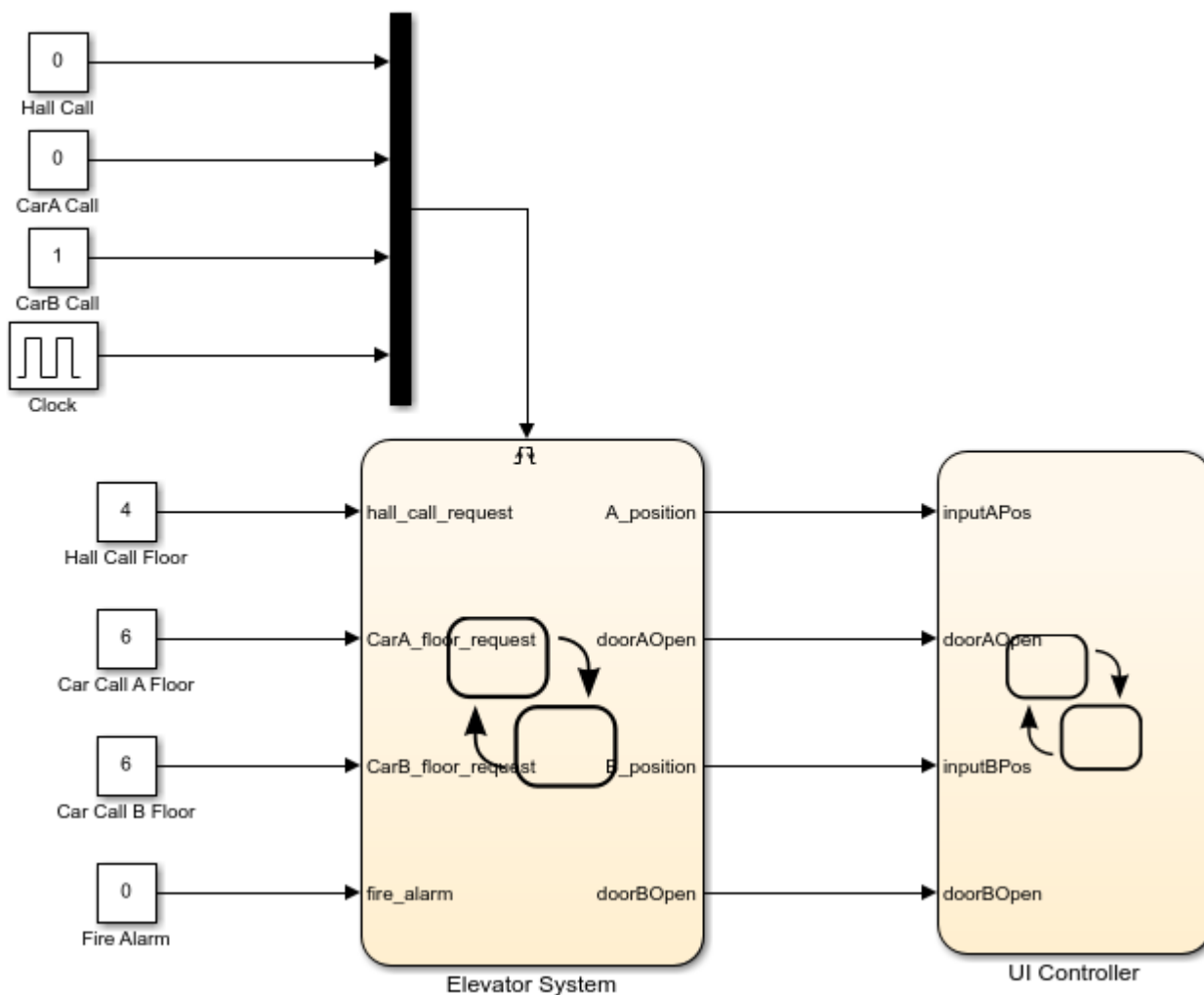

At the start of simulation, the model opens the UI. The UI shows two elevator cars that can stop at nine floors. At the bottom of the UI, two yellow rectangles represent the interior of the elevator cars. While the example is running, you call an elevator car, request a stop at a floor, or set off a fire alarm by clicking the buttons on each floor hallway and inside the elevator cars. The UI responds by modifying the input values and triggering input events for the Elevator System chart.

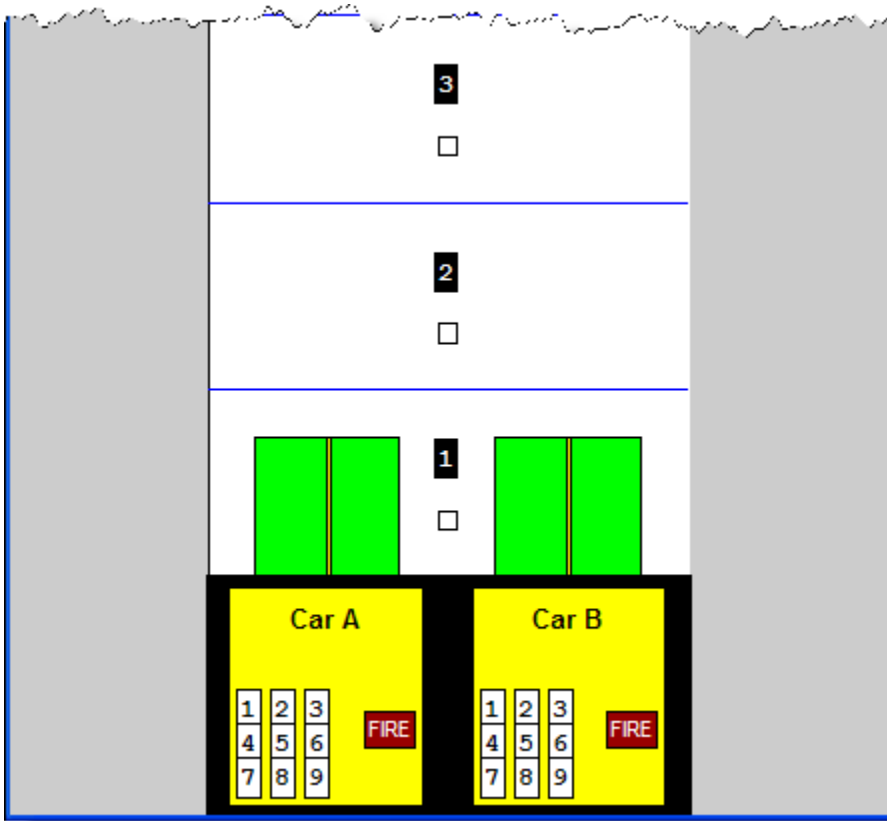

Manage Requests from User Interface

The Elevator System chart consists of three parallel subcharts. Each of these subcharts manages a queue of requests from the UI:

- The Elevator_Manager subchart implements the main control logic for the elevator system. This subchart manages the hall queue, which holds all the requests that are generated when you click a button in one of the floor hallways. The subchart processes these requests and delegates them to one of the elevator cars, depending on availability and proximity to the request.
- Elevator_A and Elevator_B represent the logic for the two elevator cars. Each car has its own queue that holds all of its floor requests. Floor requests are generated when you click a button inside the elevator car or when the Elevator_Manager delegates a request from the hall queue to the car.

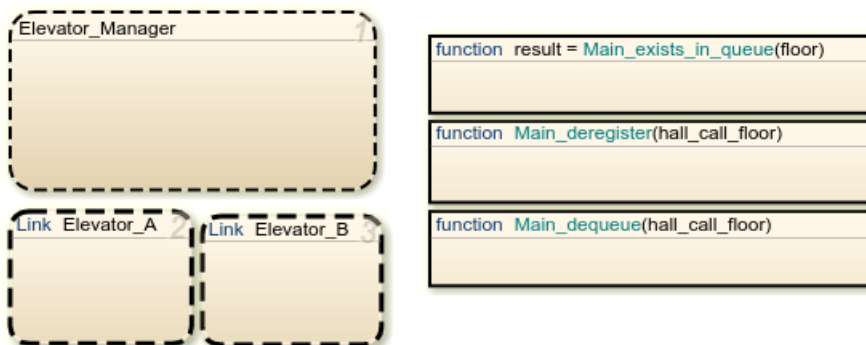

Reuse Logic Patterns by Using Atomic Subcharts

The elevator cars use identical logic to process their individual request queues. The Elevator System chart models their behavior by using linked atomic subcharts from a library model.

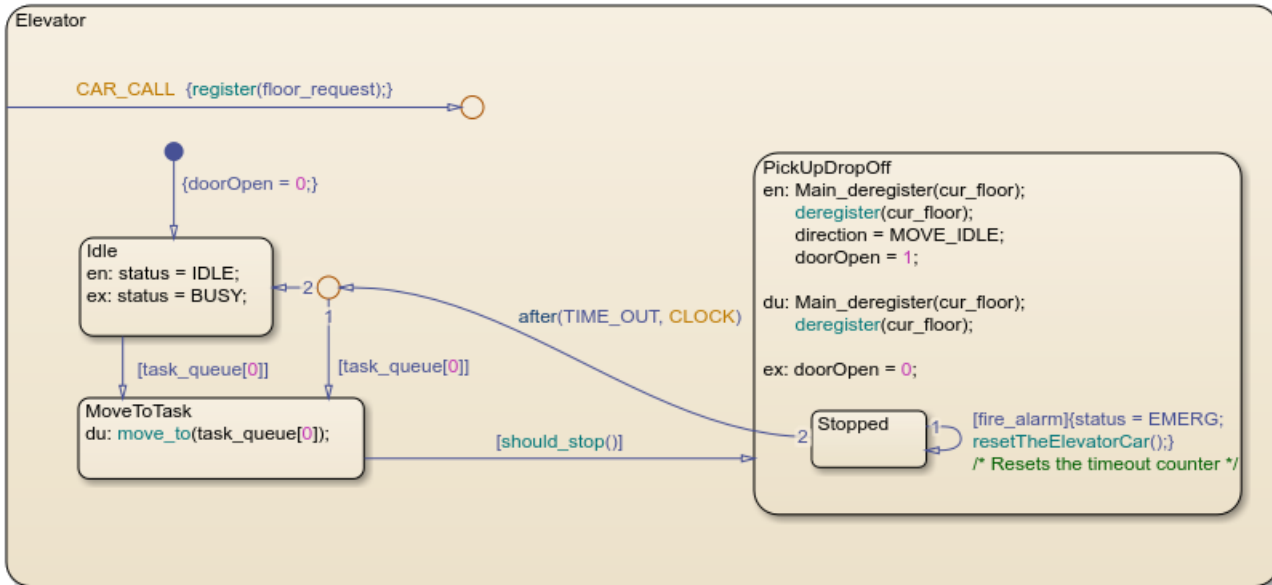

```
truthable ans = should_stop
```

```
truthable move_to(destination)
```

```
function dir = get_direction
```

```
function enqueue(task_floor)
```

```
function register(car_call_floor)
```

```
function pos = get_position
```

```
function dequeue(task_floor)
```

```
function deregister(car_call_floor)
```

```
function stat = get_status
```

```
MATLAB Function
out = ml_round(inputVal)
```

```
function resetTheElevatorCar
```

In the library model, the chart Elevator implements the logic for a generic elevator car. To program the subcharts Elevator_A and Elevator_B so that they control the appropriate car, you map data and events in each subchart to the corresponding data and events in the main chart. For instance, for Elevator_B:

- The subchart input floor_request maps to the chart input CarB_floor_request.
- The subchart output position maps to the chart output B_position.
- The subchart output doorOpen maps to the chart output doorBOpen.
- The subchart event CAR_CALL maps to the chart event CAR_CALL_B.

To see the mappings for each atomic subchart, right-click the subchart and select **Subchart Mappings**.

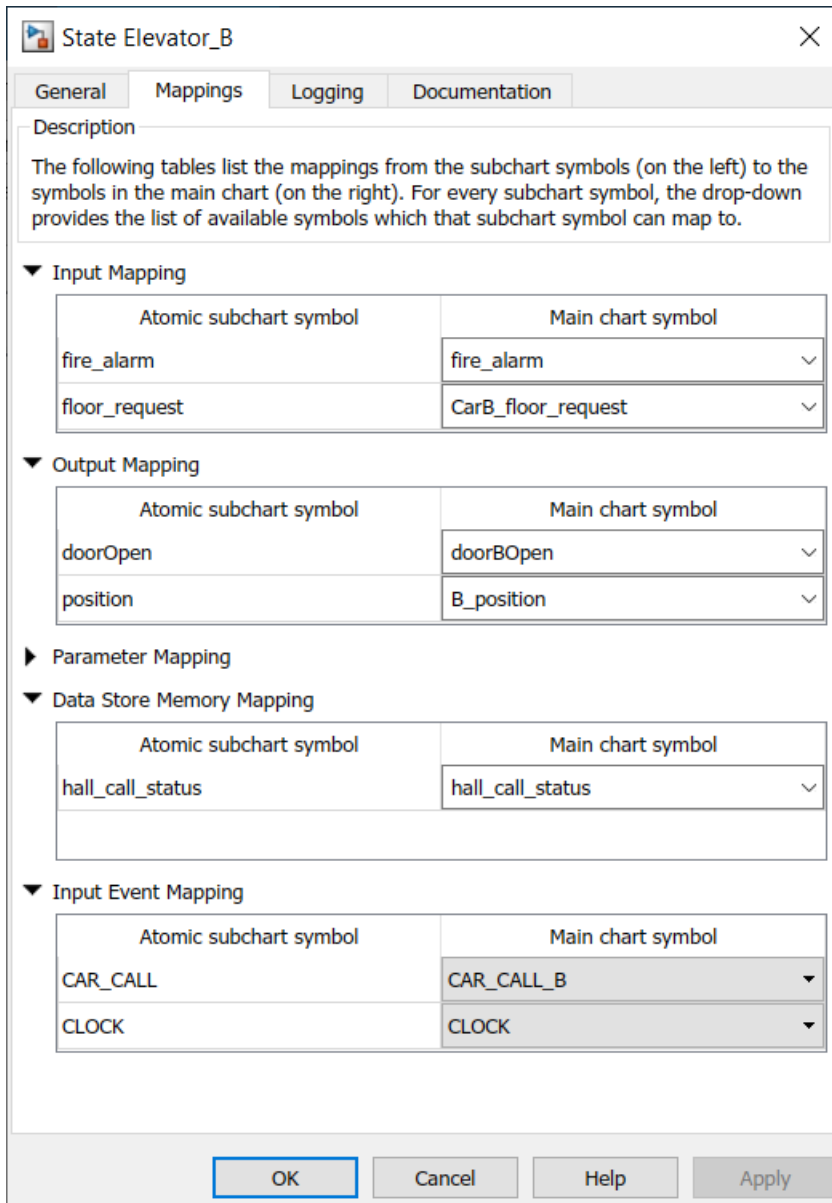

To control the UI display of each elevator car, the UI Controller chart uses two atomic subcharts linked from a library model.



For more information about using atomic subcharts to encapsulate and reuse logic, see “Create Reusable Subcomponents by Using Atomic Subcharts” on page 16-2.

Incorporate Atomic Subcharts in Your Design

The model in this example is a redesigned version of an older model that does not use atomic subcharts. The original model uses separate subcharts to manage floor requests (subcharts `Elevator_A` and `Elevator_B` of the `Elevator System` chart) and to control the UI display of elevator cars (subcharts `CarA_Controller` and `CarB_Controller` of the `UI Controller` chart). In each case, the subcharts are nearly identical copies of one another. They differ only in the names of the data and events that they use.

To convert the duplicate subcharts to atomic subcharts, first make a library atomic subchart out of one of the subcharts. Then use linked instances of this library to replace the duplicate subcharts. For example, consider the duplicate elevator car subcharts of the `Elevator System` chart. These subcharts call several functions and local variables that are defined in the `Elevator_Manager` subchart. Before creating an atomic subchart, you must make these subcharts independent and self-contained units.

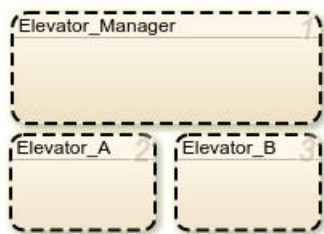

1. Migrate these functions from the `Elevator_Manager` subchart into the parent chart:

- `exists_in_queue`
- `deregister`
- `dequeue`

Rename these functions to distinguish them from the functions inside the elevator car subcharts.

2. Using the Model Explorer, migrate these variables from the `Elevator_Manager` subchart into the parent chart:

- `hall_call_queue`
- `hall_call_status`

3. In the `Elevator System` chart, set the **Export Chart Level Functions** chart property to `true`. For more information, see “Export Stateflow Functions for Reuse” on page 8-17.

4. Modify the `Elevator_Manager` and `Elevator_A` subcharts to use the migrated functions and variables.

5. Create a library atomic subchart from the `Elevator_A` subchart, as described in “Reuse a State Multiple Times in a Chart” on page 16-23.

6. To enable the atomic subchart to pass the position of the elevator car to the containing chart, change the **Scope** of the subchart data position from `Local` to `Output`.

7. Replace the two elevator subcharts with the linked atomic subchart. For each linked atomic subchart, map data and events to the parent chart. For more information, see “Map Variables for Atomic Subcharts and Boxes” on page 16-11.

See Also

More About

- “Create Reusable Subcomponents by Using Atomic Subcharts” on page 16-2
- “Export Stateflow Functions for Reuse” on page 8-17
- “Reuse a State Multiple Times in a Chart” on page 16-23
- “Map Variables for Atomic Subcharts and Boxes” on page 16-11

Save and Restore Simulations with Operating Point

- “Using Operating Points in Stateflow” on page 17-2
- “Divide a Long Simulation into Segments” on page 17-4
- “Test a Unique Chart Configuration” on page 17-8
- “Test a Chart with Fault Detection and Redundant Logic” on page 17-15
- “Methods for Interacting with the Operating Point of a Chart” on page 17-27
- “Rules for Using the Operating Point of a Chart” on page 17-30
- “Best Practices for Saving the Operating Point of a Chart” on page 17-32

Using Operating Points in Stateflow

An operating point is a snapshot of the complete state of a Simulink model at a specific time during simulation. For a Stateflow chart, an operating point includes:

- Activity of chart states
- Values of chart local data
- Values of chart output data
- Values of persistent data in MATLAB functions and Truth Table blocks

An operating point lists Stateflow objects in hierarchical order:

- Graphical objects grouped by type (box, function, or state) and in alphabetical order within each group
- Chart data grouped by scope (block output or local) and in alphabetical order within each group

For example, the following operating point illustrates the hierarchical structure of Stateflow objects.

c =

```
Block:    "shift_logic"    (handle)    (active)
Path:     sf_car/shift_logic
```

Contains:

```
+ gear_state      "State (AND)"      (active)
+ selection_state "State (AND)"      (active)
  gear            "State output data" gearType [1, 1]
  down_th        "Local scope data" double [1, 1]
  up_th          "Local scope data" double [1, 1]
```

The tree structure maps graphical and nongraphical objects to their respective locations in the chart hierarchy. If name conflicts exist, one or more underscores appear at the end of a name so that all objects have unique identifiers in the operating point hierarchy. Stateless flow charts have an empty operating point, because they do not contain states or persistent data.

For information about using an operating point for other blocks in a Simulink model, see “Save and Restore Simulation Operating Point” (Simulink).

Division of a Long Simulation into Segments

You can save the complete operating point of a model at any time during a long simulation. Then you can load that operating point and run specific segments of that simulation without starting from time $t = 0$, which saves time.

For directions, see “Divide a Long Simulation into Segments” on page 17-4.

Test of a Chart Response to Different Settings

You can modify and load the operating point of a chart to test the response of a chart to different settings. You can change the value of chart local or output data midway through a simulation or change state activity and then test how a chart responds.

Loading and modifying the operating point provides these benefits:

- Enables testing of a hard-to-reach chart configuration by loading a specific operating point
- Enables testing of the same chart configuration with different settings

For directions, see:

- “Test a Unique Chart Configuration” on page 17-8
- “Test a Chart with Fault Detection and Redundant Logic” on page 17-15

See Also

More About

- “Divide a Long Simulation into Segments” on page 17-4
- “Methods for Interacting with the Operating Point of a Chart” on page 17-27
- “Best Practices for Saving the Operating Point of a Chart” on page 17-32

Divide a Long Simulation into Segments

An operating point is a snapshot of the state of a Simulink model at a specific time during simulation. For a Stateflow chart, an operating point includes:

- Activity of chart states
- Values of chart local data
- Values of chart output data
- Values of persistent data in MATLAB functions and Truth Table blocks

For more information, see “Using Operating Points in Stateflow” on page 17-2.

Goal of the Tutorial

Suppose that you want to simulate the `sf_boiler` model without starting from $t = 0$.

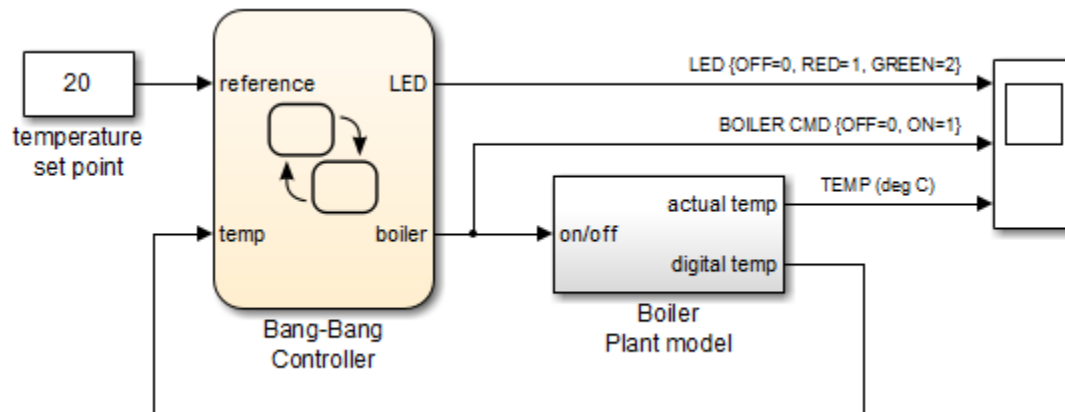

This model simulates for 1400 seconds, but the output that interests you occurs sometime between $t = 400$ and 600 . You can simulate the model, save the operating point at time $t = 400$, and then load that operating point for simulation between $t = 400$ and 600 .

Step	Task	Reference
1	Define the operating point for your chart.	“Define the Operating Point” on page 17-4
2	Load the operating point for your chart.	“Load the Operating Point” on page 17-5
3	Simulate the specific segment.	“Simulate the Specific Segment” on page 17-6

Define the Operating Point

- 1 Open the `sf_boiler` model.
- 2 Enable saving of an operating point.
 - a Open the Model Configuration Parameters dialog box and go to the **Data Import/Export** pane.
 - b Select the **Final states** check box.

- c Enter a name, such as `sf_boiler_ctx01`.
- d Select the **Save final operating point** check box.
- e Click **Apply**.

Programmatic equivalent

You can programmatically enable saving of an operating point:

```
set_param('sf_boiler','SaveFinalState','on', ...
'FinalStateName', ['sf_boiler_ctx01'], ...
'SaveOperatingPoint','on');
```

For details about setting model parameters, see `set_param`.

- 3 Define the start and stop times for this simulation segment.
 - a In the Model Configuration Parameters dialog box, go to the **Solver** pane.
 - b For **Start time**, enter 0.
 - c For **Stop time**, enter 400.
 - d Click **OK**.

Programmatic equivalent

You can programmatically set the start and stop times:

```
set_param('sf_boiler','StartTime','0', ...
'StopTime','400');
```

- 4 Start simulation.

When you simulate the model, you save the complete operating point at $t = 400$ in the variable `sf_boiler_ctx01` in the MATLAB base workspace.

- 5 Disable saving of an operating point.

This step prevents you from overwriting the operating point you saved in the previous step.

- a Open the Model Configuration Parameters dialog box and go to the **Data Import/Export** pane.
- b Clear the **Save final operating point** check box.
- c Clear the **Final states** check box.
- d Click **OK**.

Programmatic equivalent

You can programmatically disable saving of an operating point:

```
set_param('sf_boiler','SaveOperatingPoint','off', ...
'SaveFinalState','off');
```

Load the Operating Point

- 1 Enable loading of an operating point.

- a** Open the Model Configuration Parameters dialog box and go to the **Data Import/Export** pane.
- b** Select the **Initial state** check box.
- c** Enter the variable that contains the operating point of your chart: `sf_boiler_ctx01`.
- d** Click **Apply**.

Programmatic equivalent

You can programmatically enable loading of an operating point:

```
set_param('sf_boiler','LoadInitialState','on', ...  
'InitialState', ['sf_boiler_ctx01']);
```

- 2** Define the new stop time for this simulation segment.

- a** In the Model Configuration Parameters dialog box, go to the **Solver** pane.
- b** For **Stop time**, enter `600`.
- c** Click **OK**.

You do not need to enter a new start time because the simulation continues from where it left off.

Programmatic equivalent

You can programmatically set the new stop time:

```
set_param('sf_boiler','StopTime','600');
```

Simulate the Specific Segment

When you simulate the model, the following output appears in the Scope block.

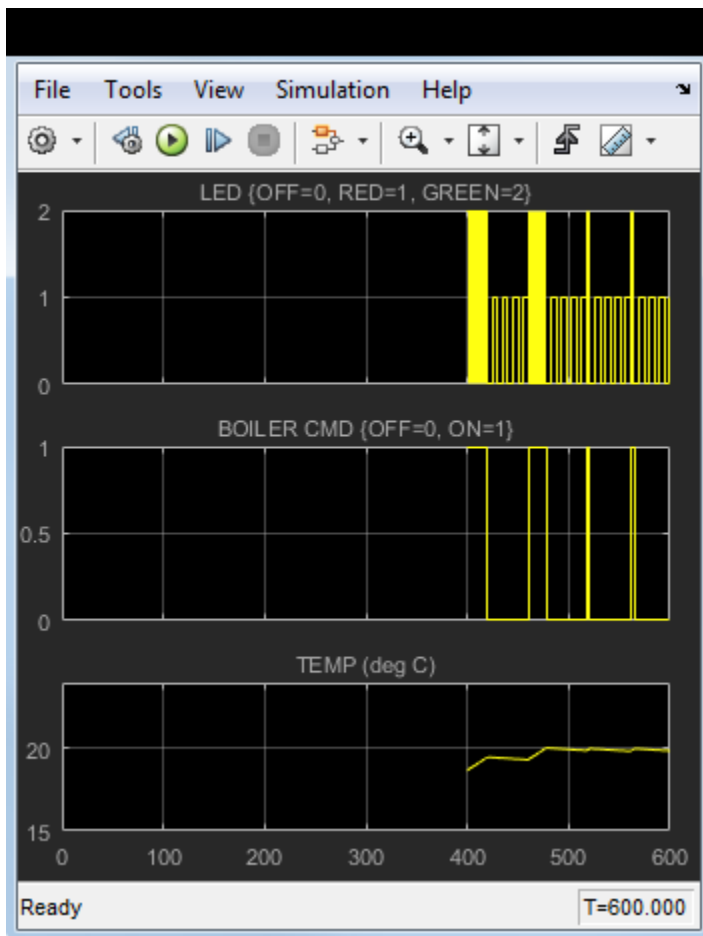

See Also

More About

- "Using Operating Points in Stateflow" on page 17-2
- "Methods for Interacting with the Operating Point of a Chart" on page 17-27
- "Best Practices for Saving the Operating Point of a Chart" on page 17-32

Test a Unique Chart Configuration

An operating point is a snapshot of the state of a Simulink model at a specific time during simulation. For a Stateflow chart, an operating point includes:

- Activity of chart states
- Values of chart local data
- Values of chart output data
- Values of persistent data in MATLAB functions and Truth Table blocks

For more information, see “Using Operating Points in Stateflow” on page 17-2.

Goal of the Tutorial

Suppose that you want to test the response of the `old_sf_car` model to a sudden change in value for `gear`.

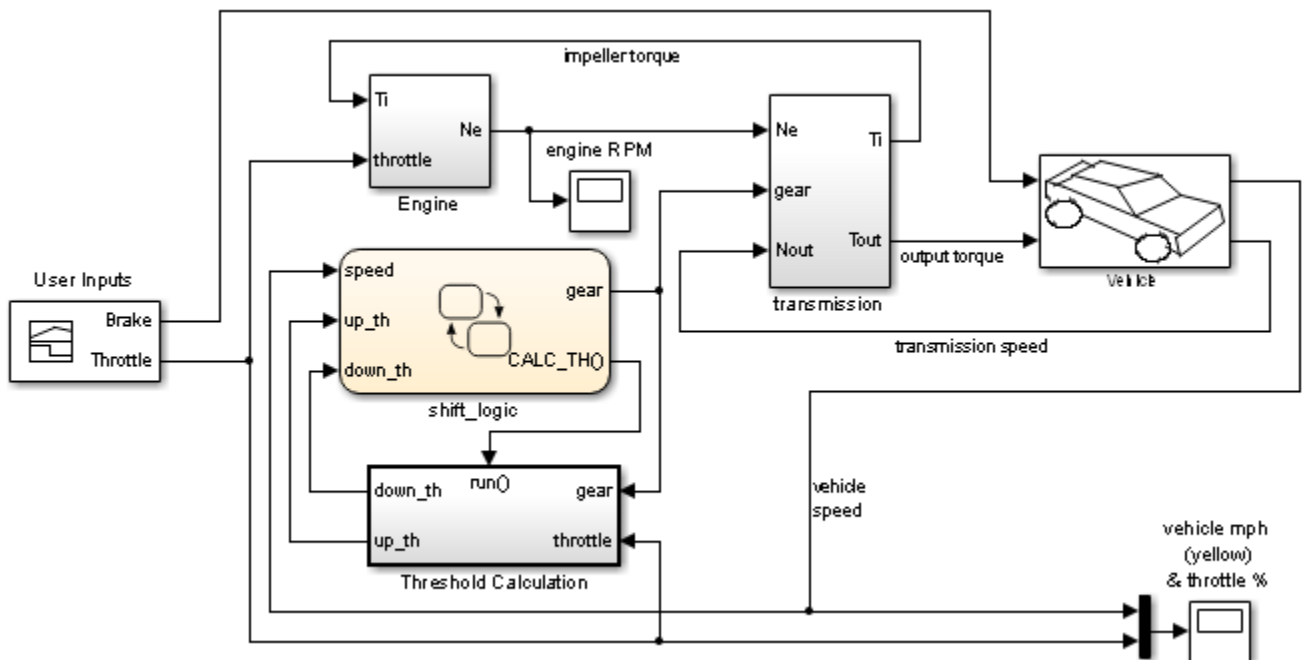

This model simulates for 30 seconds, but you want to see what happens when the value of `gear` changes at $t = 10$. You can simulate the model, save the operating point at $t = 10$, load and modify the operating point, and then simulate again between $t = 10$ and 20.

Step	Task	Reference
1	Define the operating point for your chart.	“Define the Operating Point” on page 17-9
2	Load the operating point and modify values.	“Load the Operating Point and Modify Values” on page 17-10

Step	Task	Reference
3	Test the modified operating point by running the model.	“Test the Modified Operating Point” on page 17-13

Define the Operating Point

- 1 Open the model `old_sf_car`.
- 2 Enable saving of an operating point.
 - a Open the Model Configuration Parameters dialog box and go to the **Data Import/Export** pane.
 - b Select the **Final states** check box.
 - c Enter a name, such as `old_sf_car_ctx01`.
 - d Select the **Save final operating point** check box.
 - e Click **Apply**.

Programmatic equivalent

You can programmatically enable saving of an operating point:

```
set_param('old_sf_car','SaveFinalState','on', ...
'FinalStateName','old_sf_car_ctx01', ...
'SaveOperatingPoint','on');
```

For details about setting model parameters, see `set_param`.

- 3 Define the start and stop times for this simulation segment.
 - a In the Model Configuration Parameters dialog box, go to the **Solver** pane.
 - b For **Start time**, enter 0.
 - c For **Stop time**, enter 10.
 - d Click **OK**.

Programmatic equivalent

You can programmatically set the start and stop times:

```
set_param('old_sf_car','StartTime','0', ...
'StopTime','10');
```

- 4 Start simulation.

When you simulate the model, you save the complete operating point at $t = 10$ in the variable `old_sf_car_ctx01` in the MATLAB base workspace.

At $t = 10$, the engine is operating at a steady-state value of 2500 RPM.

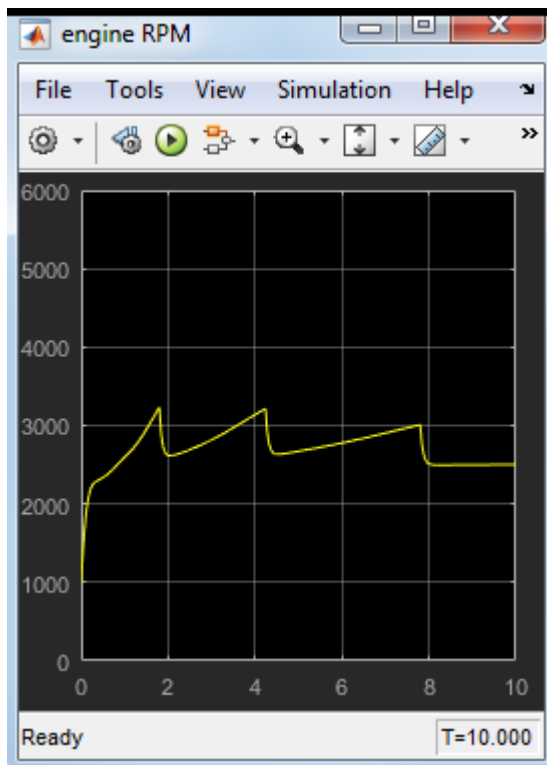

- 5 Disable saving of an operating point.

This step prevents you from overwriting the operating point you saved in the previous step.

- a Open the Model Configuration Parameters dialog box and go to the **Data Import/Export** pane.
- b Clear the **Save final operating point** check box.
- c Clear the **Final states** check box.
- d Click **OK**.

Programmatic equivalent

You can programmatically disable saving of an operating point:

```
set_param('old_sf_car','SaveOperatingPoint','off', ...
'SaveFinalState','off');
```

Load the Operating Point and Modify Values

- 1 Enable loading of an operating point.
 - a Open the Model Configuration Parameters dialog box and go to the **Data Import/Export** pane.
 - b Select the **Initial state** check box.
 - c Enter the variable that contains the operating point of your chart: `old_sf_car_ctx01`.
 - d Click **OK**.

Programmatic equivalent

You can programmatically enable loading of an operating point:

```
set_param('old_sf_car','LoadInitialState','on', ...
'InitialState', 'old_sf_car_ctx01');
```

- 2 Define an object handle for the operating point values of the `shift_logic` chart.

At the command prompt, type:

```
blockpath = 'old_sf_car/shift_logic';
c = old_sf_car_ctx01.getModelOperatingPoint('blockpath');
```

Tip If the chart appears highlighted in the model window, you can specify the block path using `gcb`:

```
c = old_sf_car_ctx01.get(gcb);
```

Copy and reference operating points with the get method

The `get` method:

- Makes a copy of the operating point of your chart, which is stored in the final state data of the model.
- Provides a root-level handle or *reference* to the copy of the operating point, which is a hierarchical tree of graphical and nongraphical chart objects.

Each node in this tree is also a handle to a state, data, or other chart object.

Note Because the entire tree consists of object handles, the following assignment statements do not work:

- `stateCopy = c.state`
- `dataCopy = c.data`
- `operatingPointCopy = c`

These assignments create copies of the object handles, not operating point values. The only way to copy operating point values is to use the `clone` method. For details, see “Methods for Interacting with the Operating Point of a Chart” on page 17-27 and “Rules for Using the Operating Point of a Chart” on page 17-30.

- 3 Look at the contents of the operating point.

```
c =
```

```
Block:    "shift_logic"    (handle)    (active)
Path:     old_sf_car/shift_logic
```

```
Contains:
```

```
+ gear_state      "State (AND)"      (active)
+ selection_state "State (AND)"      (active)
```

gear "Block output data" double [1, 1]

The operating point of your chart contains a list of states and data in hierarchical order.

- Highlight the states that are active in your chart at t = 10.

At the command prompt, type:

```
c.highlightActiveStates;
```

In the chart, all active states appear highlighted.

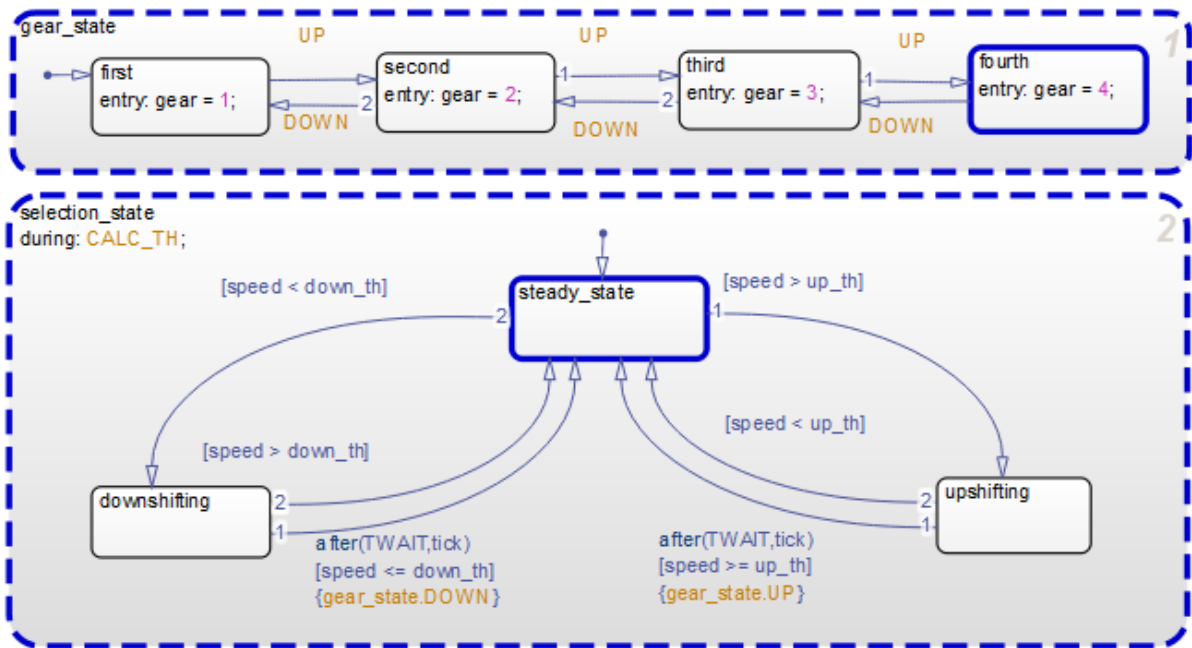

Tip To check if a single state is active, you can use the `isActive` method. For example, type:

```
c.gear_state.fourth.isActive
```

This command returns true (1) when a state is active and false (0) otherwise. For information on other methods, see "Methods for Interacting with the Operating Point of a Chart" on page 17-27.

- Change the active substate of `selection_state` to `downshifting`.

Use this command:

```
c.selection_state.downshifting.setActive;
```

The newly active substate appears highlighted in the chart.

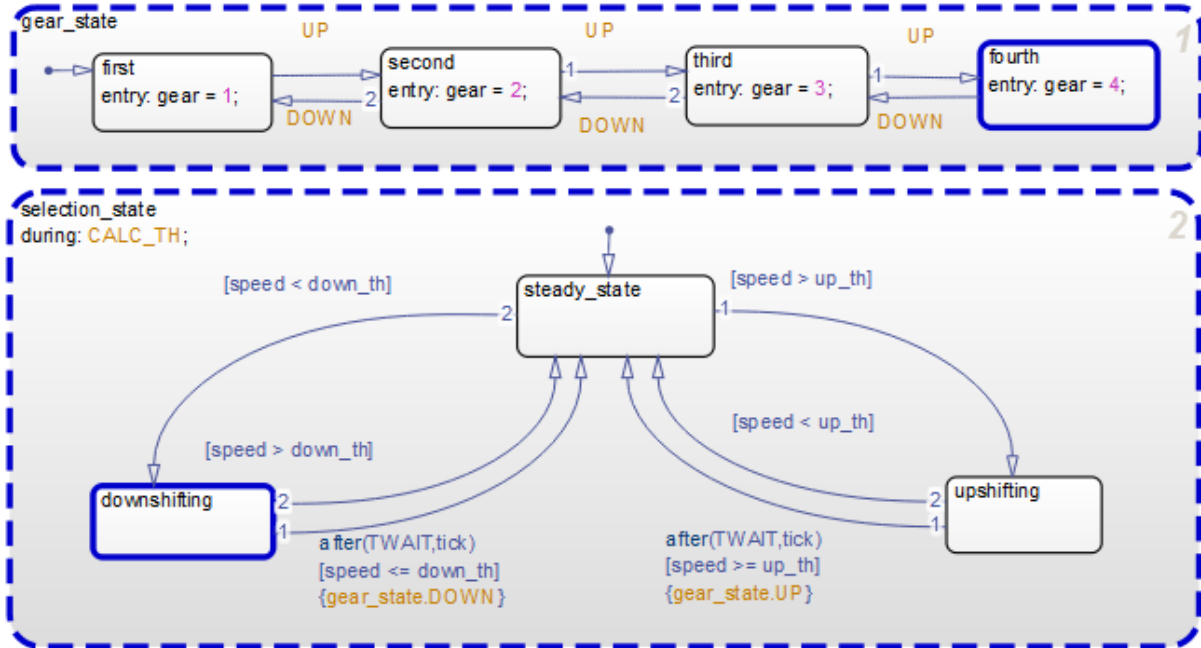

6 Change the value of output data gear.

When you type `c.gear` at the command prompt, you see a list of data properties similar to this:

```
>> c.gear
```

```
ans =
```

```

Description: 'Block output data'
DataType: 'double'
Size: '[1, 1]'
Range: [1x1 struct]
InitialValue: [1x0 double]
Value: 4

```

You can change the value of `gear` from 4 to 1 by typing

```
c.gear.Value = 1;
```

However, you cannot change the data type or size of `gear`. Also, you cannot specify a new value that falls outside the range set by the **Minimum** and **Maximum** parameters. For details, see “Rules for Modifying Data Values” on page 17-30 .

7 Save the modified operating point.

Use this command:

```
old_sf_car_ctx01 = old_sf_car_ctx01.set(blockpath, c);
```

Test the Modified Operating Point

1 Define the new stop time for the simulation segment to test.

- a In the Model Configuration Parameters dialog box, go to the **Solver** pane.
- b For **Stop time**, enter 20.
- c Click **OK**.

You do not need to enter a new start time because the simulation continues from where it left off.

Programmatic equivalent

You can programmatically set the stop time:

```
set_param('old_sf_car','StopTime','20');
```

- 2 Start simulation.

The engine reacts as follows:

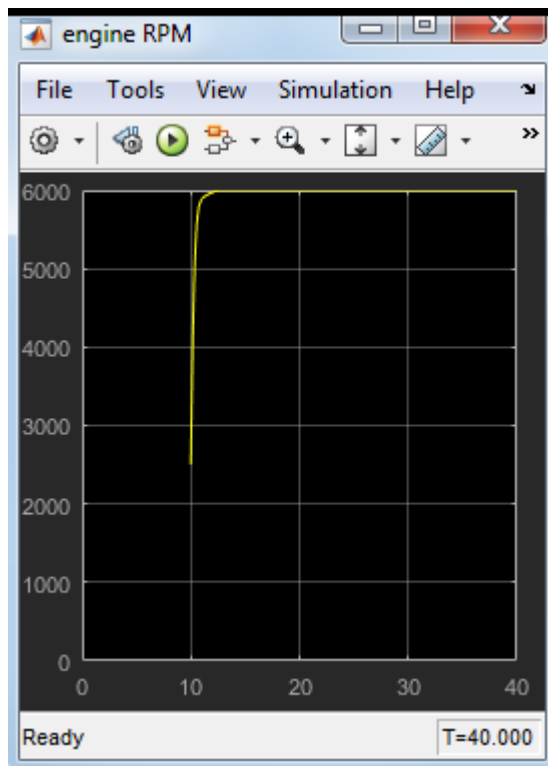

See Also

More About

- "Using Operating Points in Stateflow" on page 17-2
- "Methods for Interacting with the Operating Point of a Chart" on page 17-27
- "Best Practices for Saving the Operating Point of a Chart" on page 17-32

Test a Chart with Fault Detection and Redundant Logic

An operating point is a snapshot of the state of a Simulink model at a specific time during simulation. For a Stateflow chart, an operating point includes:

- Activity of chart states
- Values of chart local data
- Values of chart output data
- Values of persistent data in MATLAB functions and Truth Table blocks

For more information, see “Using Operating Points in Stateflow” on page 17-2.

Goal of the Tutorial

Suppose that you want to test the response of the `sf_aircraft` model to one or more actuator failures in an elevator system. For details of how this model works, see “Detect Faults in Aircraft Elevator Control System”.

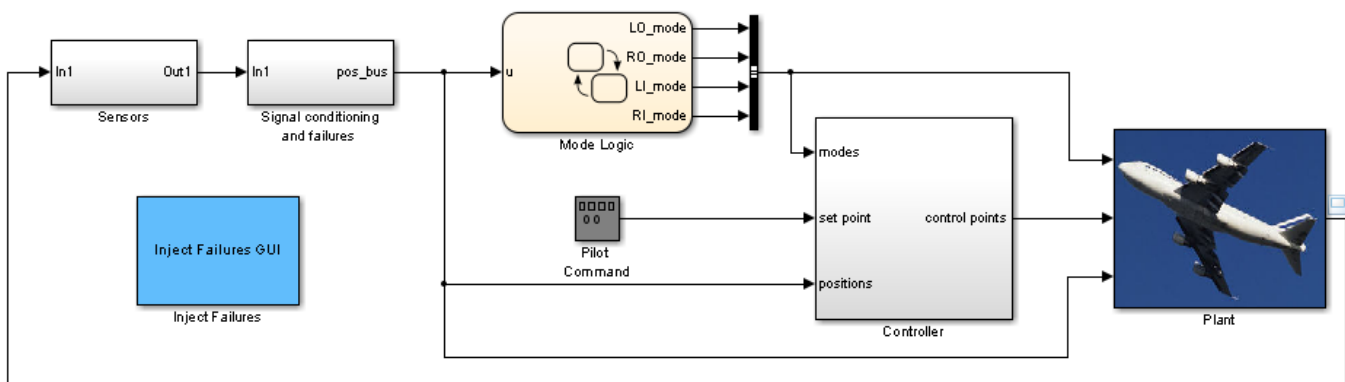

The Mode Logic chart monitors the status of actuators for two elevators. Each elevator has an outer (primary) actuator and an inner (secondary) actuator. In normal operation, the outer actuators are active and the inner actuators are on standby.

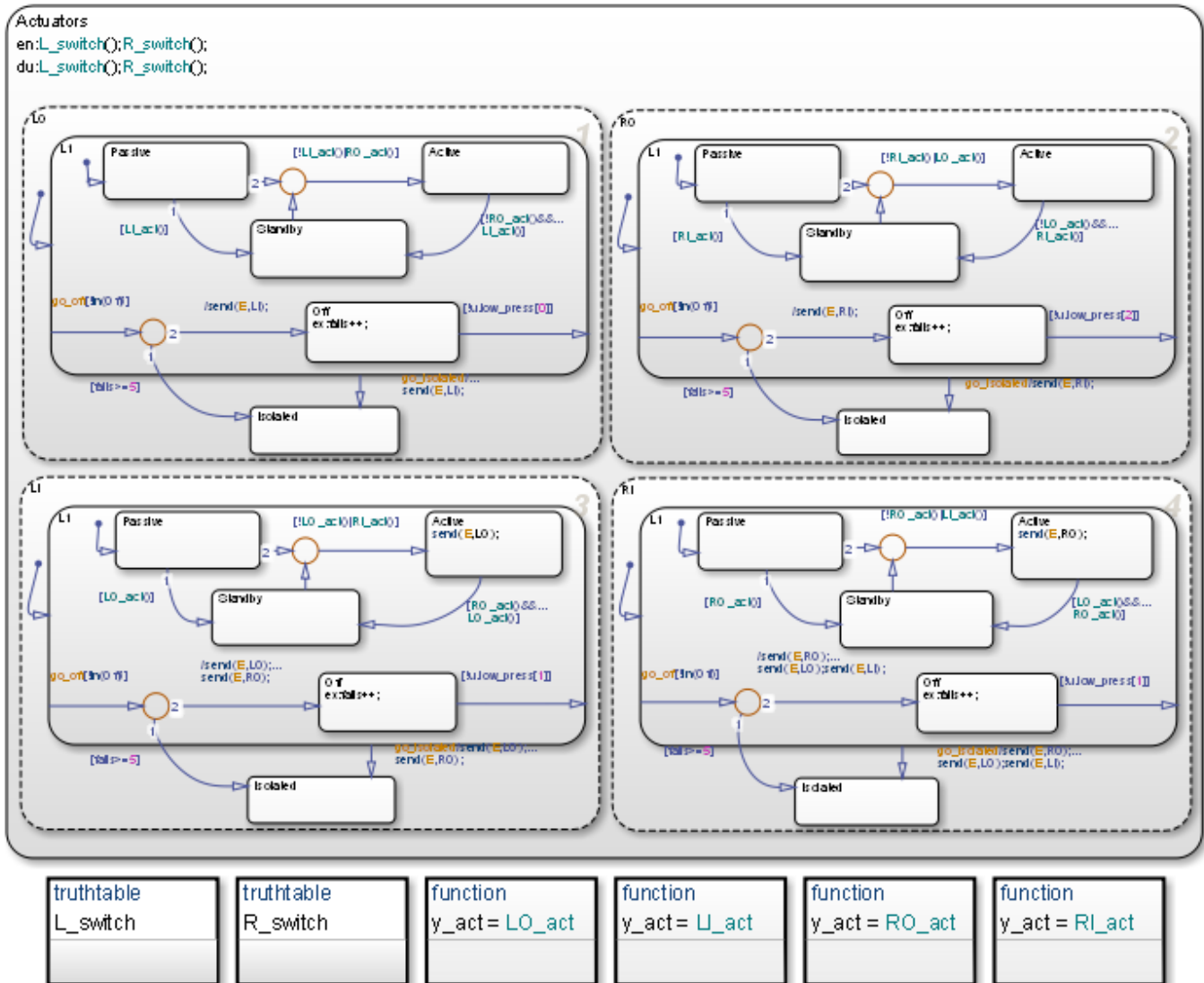

When the four actuators are working correctly, the left and right elevators reach steady-state positions in 3 seconds.

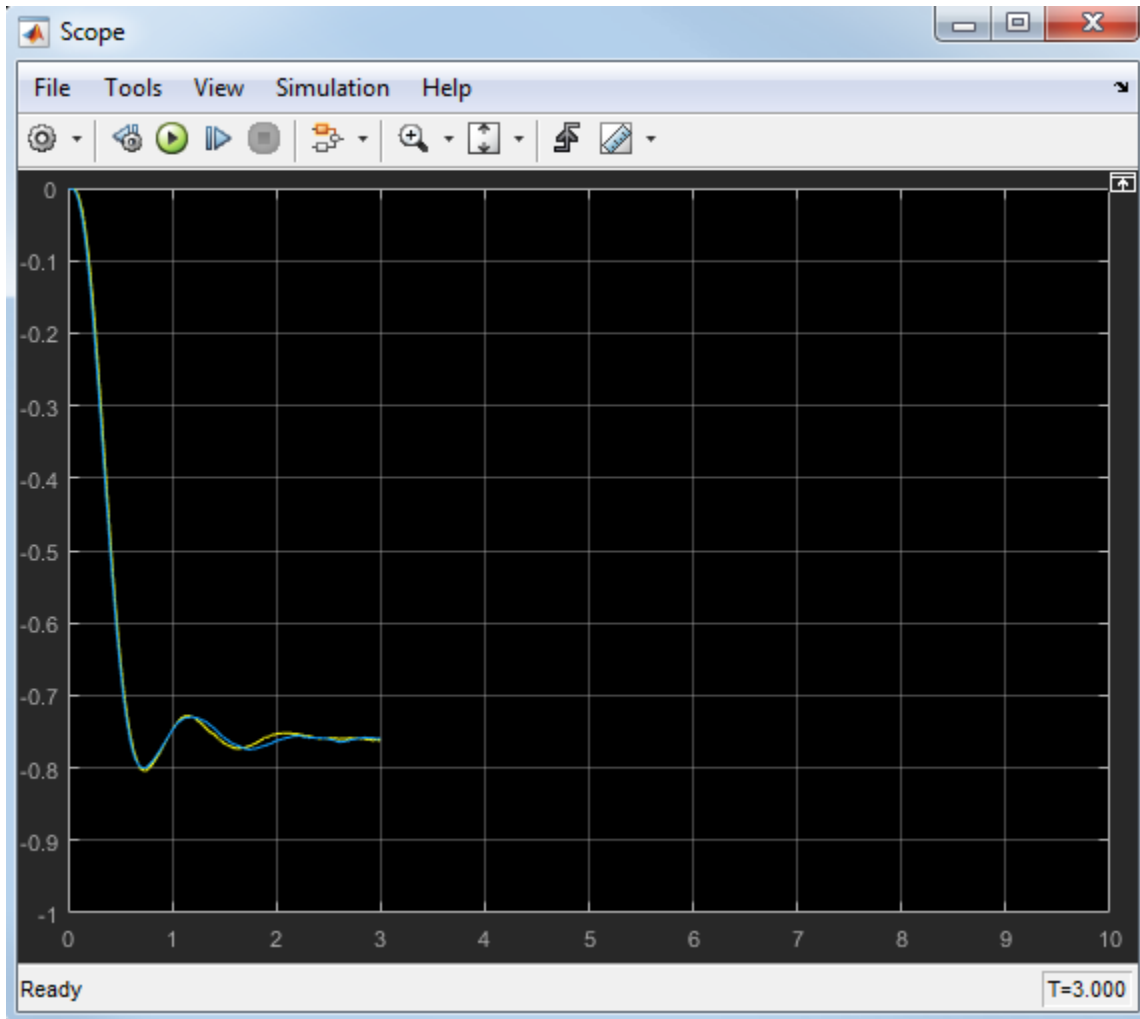

Suppose that you want to see what happens at $t = 3$ when at least one actuator fails. You can simulate the model, save the operating point at $t = 3$, load and modify the operating point, and then simulate again between $t = 3$ and 10.

Step	Task	Reference
1	Define the operating point for your chart.	"Define the Operating Point" on page 17-18
2	Load the operating point and modify values for one actuator failure.	"Modify Operating Point Values for One Actuator Failure" on page 17-19
3	Test the modified operating point by running the model.	"Test the Operating Point for One Failure" on page 17-22
4	Modify operating point values for two actuator failures.	"Modify Operating Point Values for Two Actuator Failures" on page 17-24
5	Test the modified operating point by running the model again.	"Test the Operating Point for Two Failures" on page 17-25

Define the Operating Point

- 1 Open the `sf_aircraft` model.
- 2 Enable saving of an operating point.
 - a Open the Model Configuration Parameters dialog box and go to the **Data Import/Export** pane.
 - b Select the **Final states** check box.
 - c Enter a name, such as `xFinal`.
 - d Select the **Save final operating point** check box.
 - e Click **Apply**.

Programmatic equivalent

You can programmatically enable saving of an operating point:

```
set_param('sf_aircraft','SaveFinalState','on', ...  
'FinalStateName', ['xFinal'], ...  
'SaveOperatingPoint','on');
```

For details about setting model parameters, see `set_param`.

- 3 Define the stop time for this simulation segment.
 - a In the Model Configuration Parameters dialog box, go to the **Solver** pane.
 - b For **Stop time**, enter 3.
 - c Click **OK**.

Programmatic equivalent

You can programmatically set the stop time:

```
set_param('sf_aircraft','StopTime','3');
```

- 4 Start simulation.

When you simulate the model, you save the complete operating point at $t = 3$ in the variable `xFinal` in the MATLAB base workspace.
- 5 Disable saving of an operating point.

This step prevents you from overwriting the operating point you saved in the previous step.

- a Open the Model Configuration Parameters dialog box and go to the **Data Import/Export** pane.
- b Clear the **Save final operating point** check box.
- c Clear the **Final states** check box.
- d Click **OK**.

Programmatic equivalent

You can programmatically disable saving of an operating point:

```
set_param('sf_aircraft','SaveOperatingPoint','off', ...  
'SaveFinalState','off');
```

Modify Operating Point Values for One Actuator Failure

- 1 Enable loading of an operating point.
 - a Open the Model Configuration Parameters dialog box and go to the **Data Import/Export** pane.
 - b Select the **Initial state** check box.
 - c Enter the variable that contains the operating point of your chart: `xFinal`.
 - d Click **OK**.

Programmatic equivalent

You can programmatically enable loading of an operating point:

```
set_param('sf_aircraft','LoadInitialState','on', ...
'InitialState', ['xFinal']);
```

- 2 Define an object handle for the operating point values of the Mode Logic chart.

At the command prompt, type:

```
blockpath = 'sf_aircraft/Mode Logic';
c = xFinal.get(blockpath);
```

Tip If the chart appears highlighted in the model window, you can specify the block path using `gcb`:

```
c = xFinal.get(gcb);
```

Use the get method for Operating Points

The `get` method:

- Makes a copy of the operating point of your chart, which is stored in the final state data of the model.
- Provides a root-level handle or *reference* to the copy of the operating point, which is a hierarchical tree of graphical and nongraphical chart objects.

Each node in this tree is also a handle to a state, data, or other chart object.

Note Because the entire tree consists of object handles, the following assignment statements do not work:

- `stateCopy = c.state`
- `dataCopy = c.data`
- `operatingPointCopy = c`

These assignments create copies of the object handles, not operating point values. The only way to copy operating point values is to use the `clone` method. For details, see “Methods for Interacting with the Operating Point of a Chart” on page 17-27 and “Rules for Using the Operating Point of a Chart” on page 17-30.

- 3** Look at the contents of the operating point.

`c =`

```
Block: "Mode Logic" (handle) (active)
```

```
Path: sf_aircraft/Mode Logic
```

Contains:

```
+ Actuators "State (OR)" (active)
+ LI_act "Function"
+ LO_act "Function"
+ L_switch "Function"
+ RI_act "Function"
+ RO_act "Function"
+ R_switch "Function"
+ LI_mode "State output data" sf_aircraft_ModeType [1,1]
+ LO_mode "State output data" sf_aircraft_ModeType [1,1]
+ RI_mode "State output data" sf_aircraft_ModeType [1,1]
+ RO_mode "State output data" sf_aircraft_ModeType [1,1]
```

The operating point of your chart contains a list of states, functions, and data in hierarchical order.

- 4** Highlight the states that are active in your chart at $t = 3$.

At the command prompt, type:

```
c.highlightActiveStates;
```

Active states appear highlighted. By default, the two outer actuators are active and the two inner actuators are on standby.

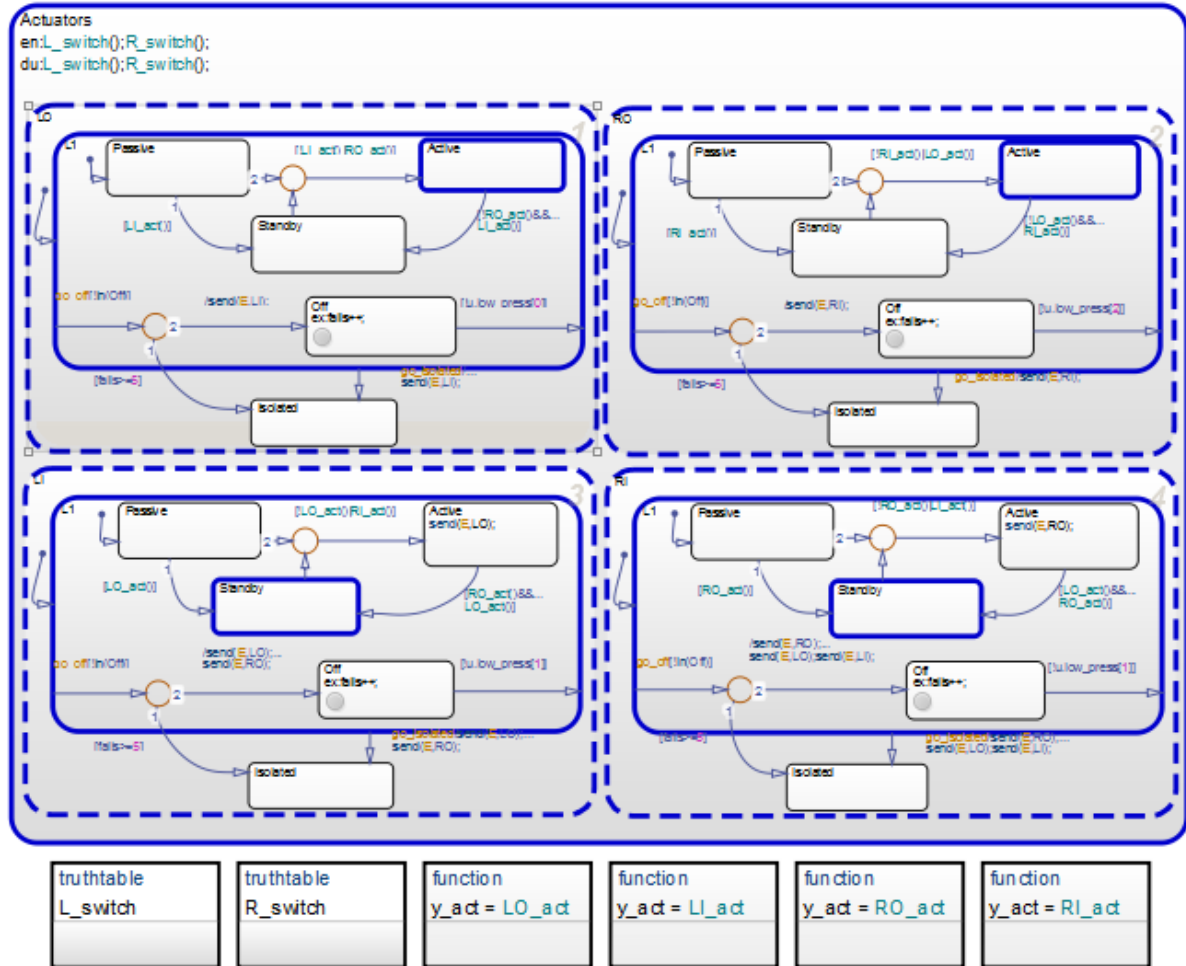

Tip To check if a single state is active, you can use the `isActive` method. For example, type:

```
c.Actuators.LI.L1.Standby.isActive
```

This command returns true (1) when a state is active and false (0) otherwise. For information on other methods, see “Methods for Interacting with the Operating Point of a Chart” on page 17-27.

- 5 Change the state activity in the chart to reflect one actuator failure.

Assume that the left outer (LO) actuator fails. To change the state, use this command:

```
c.Actuators.L0.Isolated.setActive;
```

The newly active substate appears highlighted in the chart.

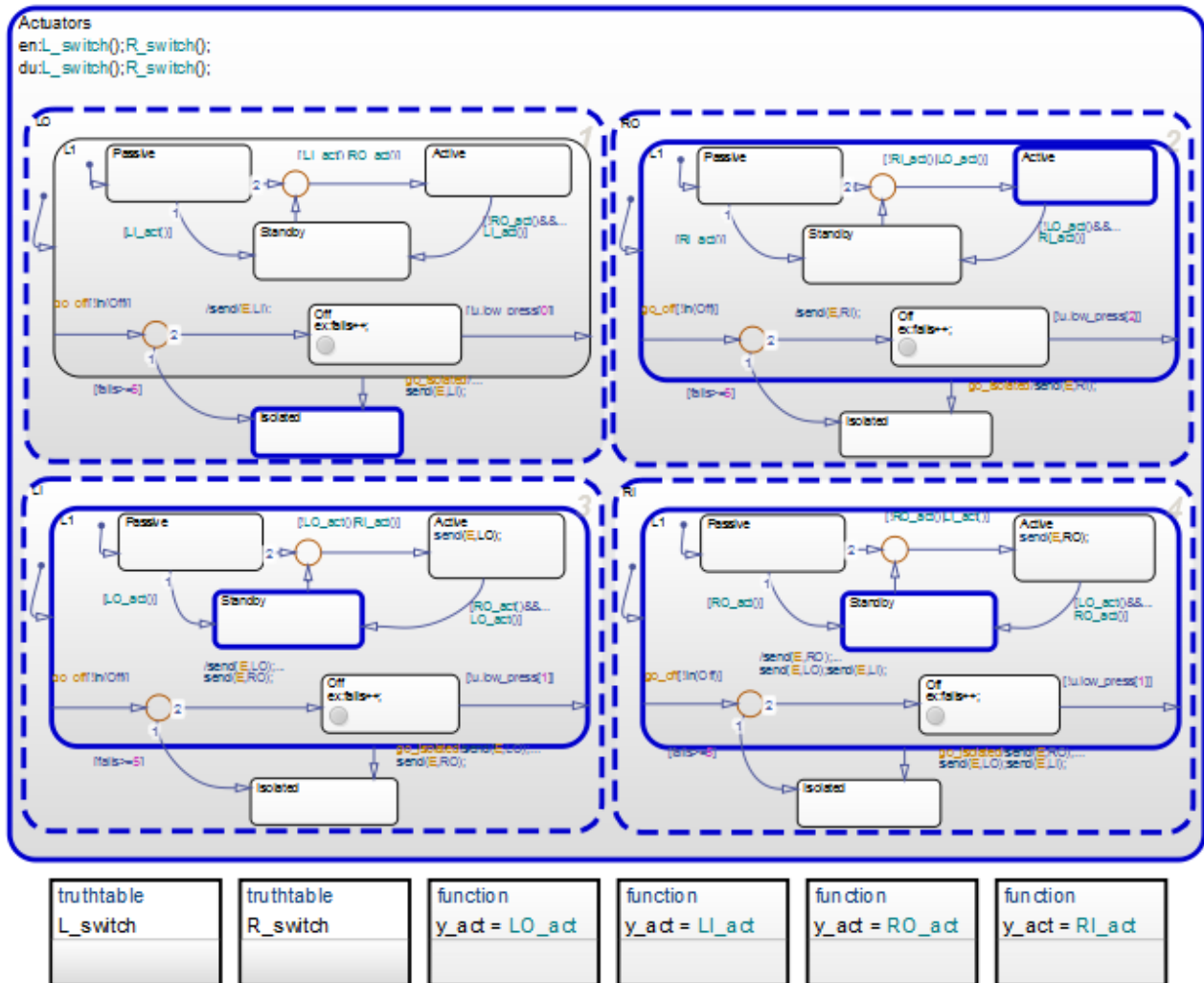

This mode logic assumes that there are 3 hydraulic lines, one that is connected to the 2 redundant actuators (Left Inner and Right Inner actuators). The other two are connected to the primary actuators Left Outer and Right Outer (1 per actuator).

The setActive method ensures that the chart exits and enters the appropriate states to maintain state consistency. However, the method does not perform entry actions for the newly active substate. Similarly, the method does not perform exit actions for the previously active substate.

- 6 Save the modified operating point by using this command:

```
xFinal = xFinal.set(blockpath, c);
```

Test the Operating Point for One Failure

- 1 Define the new stop time for the simulation segment to test.
 - a Go to the **Solver** pane of the Model Configuration Parameters dialog box.
 - b For **Stop time**, enter 10.
 - c Click **OK**.

You do not need to enter a new start time because the simulation continues from where it left off.

Programmatic equivalent

You can programmatically set the stop time:

```
set_param('sf_aircraft','StopTime','10');
```

- 2 Start simulation.

Chart animation shows that the other three actuators react appropriately to the failure of the left outer (LO) actuator.

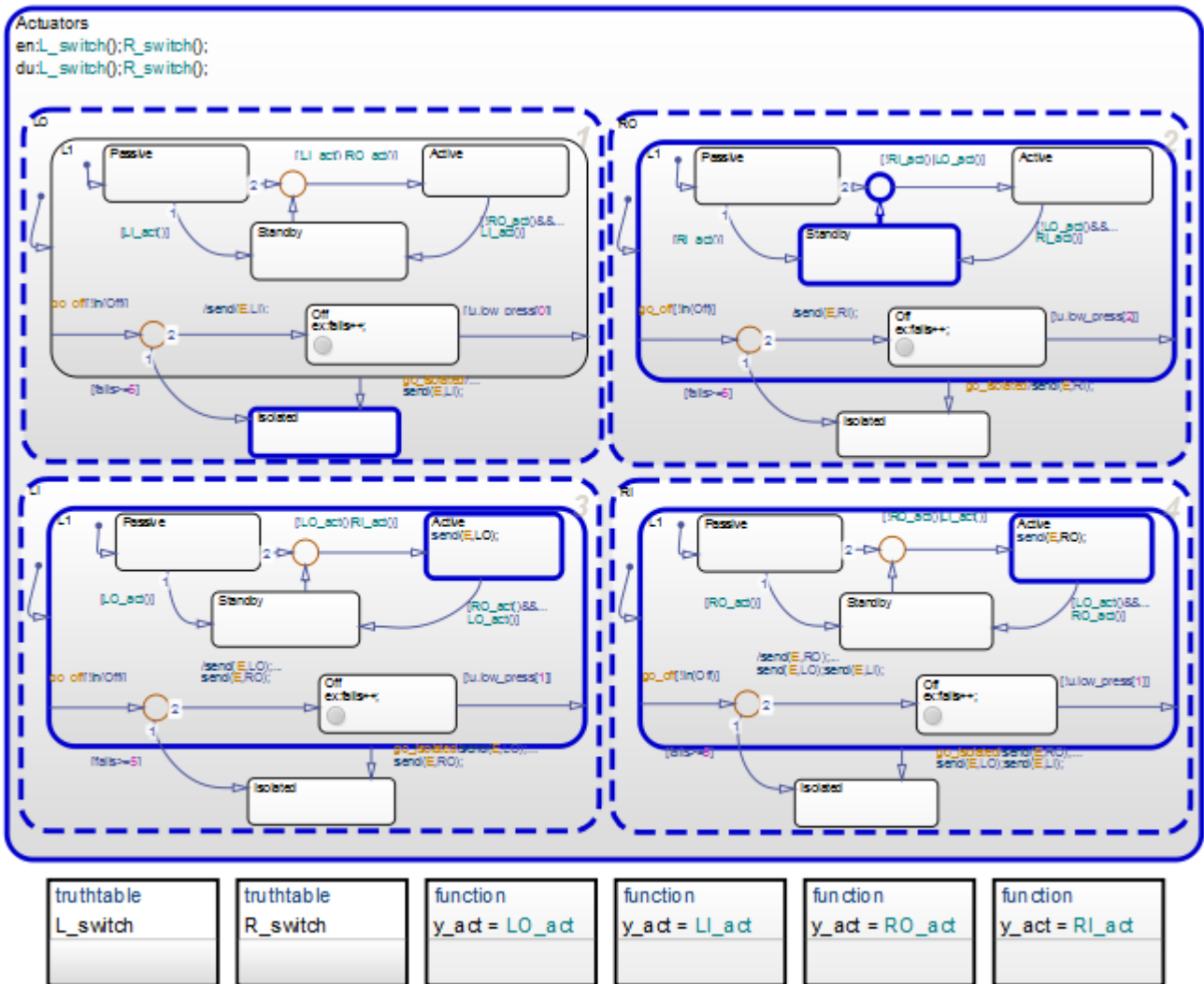

This mode logic assumes that there are 3 hydraulic lines, one that is connected to the 2 redundant actuators (Left Inner and Right Inner actuators). The other two are connected to the primary actuators Left Outer and Right Outer (1 per actuator).

This actuator...	Switches from...	Because...
Left inner (LI)	Standby to active	The left elevator must compensate for the left outer (LO) actuator failure.
Right inner (RI)	Standby to active	The same hydraulic line connects to both inner actuators.
Right outer (RO)	Active to standby	Only one actuator per elevator can be active.

Both elevators continue to maintain steady-state positions.

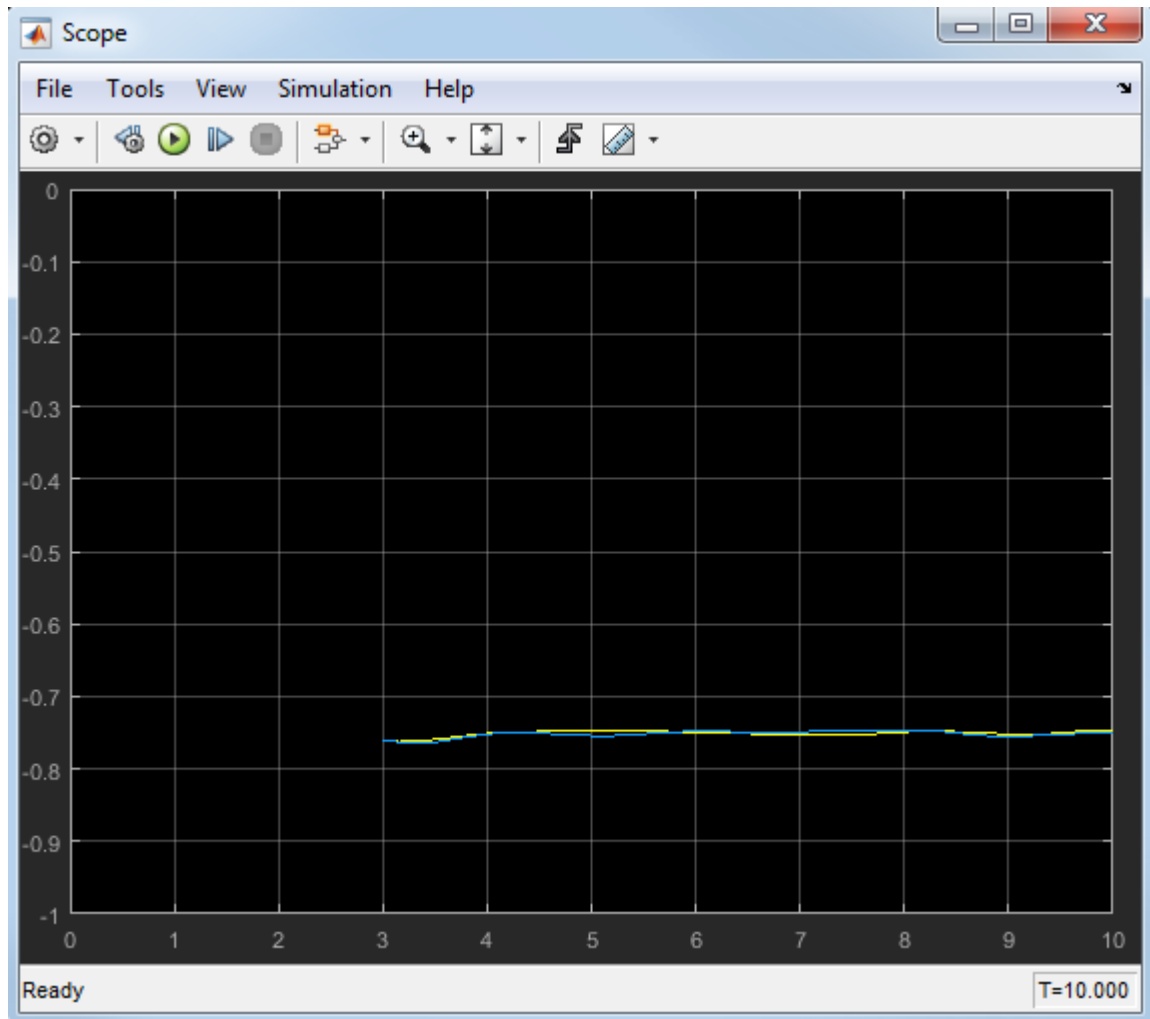

Modify Operating Point Values for Two Actuator Failures

- 1 Change the state activity in the chart to reflect two actuator failures.

Assume that the left inner (LI) actuator also fails. To change the state, use this command:

```
c.Actuators.LI.Isolated.setActive;
```

- 2 Save the modified operating point by using this command:

```
xFinal = xFinal.set(blockpath, c);
```

Test the Operating Point for Two Failures

- 1 In the Model Configuration Parameters dialog box, verify that the stop time is 10.
- 2 Restart simulation.

Because of failures in both actuators, the left elevator stops working. The right elevator maintains a steady-state position.

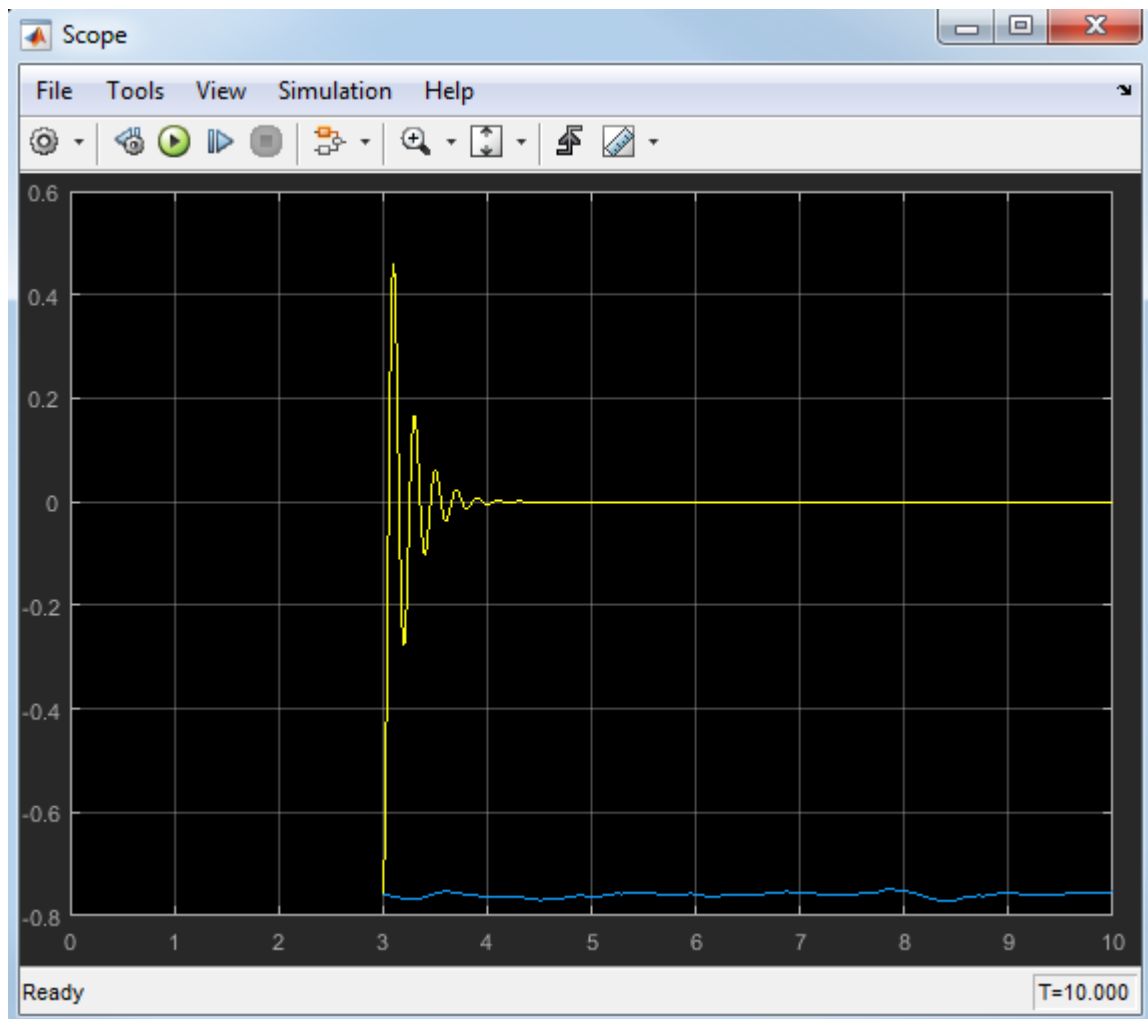

If you modify the operating point of your chart to test the response of the right elevator to actuator failures, you get similar results.

See Also

More About

- “Using Operating Points in Stateflow” on page 17-2
- “Methods for Interacting with the Operating Point of a Chart” on page 17-27
- “Best Practices for Saving the Operating Point of a Chart” on page 17-32

Methods for Interacting with the Operating Point of a Chart

An operating point is a snapshot of the state of a Simulink model at a specific time during simulation. For a Stateflow chart, an operating point includes:

- Activity of chart states
- Values of chart local data
- Values of chart output data
- Values of persistent data in MATLAB functions and Truth Table blocks

For more information, see “Using Operating Points in Stateflow” on page 17-2.

You can use the following methods to interact with the operating point of a chart. Assume that *ch* is a handle to the operating point of your chart, which you obtain using the `get` method.

Type of Object	Method	Description	Example
All chart objects	<code>open</code>	<p>For graphical objects, highlights the object in the Stateflow Editor.</p> <p>For nongraphical objects, highlights the object in the Model Explorer.</p> <p>Note For persistent data in MATLAB functions, this method opens the function editor and highlights the persistent data at the exact line in the script.</p>	<code>ch.data.open</code>

Type of Object	Method	Description	Example
Chart	checkStateConsistency	<p>Verifies that all states in a chart are consistent.</p> <ul style="list-style-type: none"> • If a state is inactive, no substates are active. • If a state with parallel decomposition is active, all substates are active. • If a state with exclusive decomposition is active, only one substate is active. 	<i>ch.checkStateConsistency</i>
Chart	clone	Copies the entire chart operating point to a new variable.	<i>newOperatingPoint = ch.clone</i>
Chart	highlightActiveStates	Highlights all active states in the Stateflow Editor.	<i>ch.highlightActiveStates</i>
Chart	isStateConsistent	Returns true (1) if all states pass a consistency check and false (0) otherwise.	<i>ch.isStateConsistent</i>
Chart	removeHighlighting	Removes all highlighting in the Stateflow Editor.	<i>ch.removeHighlighting</i>
State	isActive	Returns true (1) if a state is active and false (0) otherwise.	<i>ch.state.isActive</i>
State Must be an exclusive leaf state	setActive	<p>Sets a state to be active.</p> <p>This method ensures that no other exclusive states at that level are active.</p>	<i>ch.state.substate.setActive</i>

Type of Object	Method	Description	Example
State Must have a history junction and exclusive substates	<code>getPrevActiveChild</code>	Returns the previously active substate.	<code>ch.state.getPrevActiveChild</code>
State Must be inactive; must have a history junction and exclusive substates	<code>setPrevActiveChild</code>	Sets the previously active substate.	<code>ch.state.setPrevActiveChild('B')</code> Note The argument must be the name of a substate (in quotes), or the full operating point path to a substate (without quotes).

See Also

More About

- “Using Operating Points in Stateflow” on page 17-2
- “Divide a Long Simulation into Segments” on page 17-4
- “Best Practices for Saving the Operating Point of a Chart” on page 17-32

Rules for Using the Operating Point of a Chart

An operating point is a snapshot of the state of a Simulink model at a specific time during simulation. For a Stateflow chart, an operating point includes:

- Activity of chart states
- Values of chart local data
- Values of chart output data
- Values of persistent data in MATLAB functions and Truth Table blocks

For more information, see “Using Operating Points in Stateflow” on page 17-2.

Limitations on Values You Can Modify

An operating point does not include information about these elements:

- Machine-parented data
- Persistent data in custom C code
- Persistent data in external MATLAB code

Therefore, you cannot modify the values of those elements.

Rules for Modifying Data Values

These rules apply when you modify data values:

- You cannot change the data type or size. Scalar data must remain scalar. Vector and matrix data must keep the same dimensions. The only exception to this rule is Stateflow data of `ml` type (see “ml Data Type” on page 13-31 for details).
- For enumerated data types, you can choose only enumerated values from the type definition. For other data types, new values must fall within the range that you specify in the **Minimum** and **Maximum** parameters.
- Use one-based indexing to define rows and columns of a matrix.

Suppose that you want to change the value of an element in a 21-by-12 matrix. To modify the element in the first row and second column, type:

```
c.state_name.data_name.Value(1,2) = newValue;
```

Rules for Modifying State Activity

These rules apply when you use the `setActive` method on an exclusive (OR) leaf state:

- State-parented local data does not reinitialize.
- The newly active state does not execute any entry actions. Similarly, the previously active state does not execute any exit actions.

If you want these state actions to occur, you must execute them separately. For example, if your state actions assign values to data, you must assign the values explicitly.

- The `setActive` method tries to maintain state consistency by:
 - Updating state activity for parent, grandparent, and sibling states
 - Resetting temporal counters for newly active states
 - Updating values of state output data (read-only)
 - Enabling or disabling function-call subsystems and Simulink functions that bind to states
- The `highlightActiveStates` method also executes when these conditions are true:
 - The model is open.
 - The chart is visible.
 - The `highlightActiveStates` method has executed at least once, but not the `removeHighlighting` method.

Restriction on Continuous-Time Charts

After you load an operating point for a continuous-time chart, you can restart simulation from a nonzero time. However, you cannot modify the state activity or any data values, because the operating point for a continuous-time chart is read-only. For more information, see “Continuous-Time Modeling in Stateflow” on page 22-2.

No Partial Loading of a Operating Point

When you load an operating point, the complete operating point is available as a variable in the MATLAB base workspace. You cannot perform partial loading of an operating point for a subset of chart objects.

Restriction on Copying Operating Point Values

Use the `clone` method to copy an entire operating point to a new variable (see “Methods for Interacting with the Operating Point of a Chart” on page 17-27). You cannot copy a subset of operating point values, because the `clone` method works only at the chart level.

Suppose that you obtain a handle to the operating point of your chart using these commands:

```
blockpath = 'model/chart';
c = xFinal.get(modelOperatingPoint, blockpath);
```

Assignment statements such as `stateCopy = c.state`, `dataCopy = c.data`, and `operatingPointCopy = c` do not work. These assignments create copies of object handles, not operating point values.

See Also

More About

- “Using Operating Points in Stateflow” on page 17-2
- “Divide a Long Simulation into Segments” on page 17-4
- “Best Practices for Saving the Operating Point of a Chart” on page 17-32

Best Practices for Saving the Operating Point of a Chart

An operating point is a snapshot of the state of a Simulink model at a specific time during simulation. For a Stateflow chart, an operating point includes:

- Activity of chart states
- Values of chart local data
- Values of chart output data
- Values of persistent data in MATLAB functions and Truth Table blocks

For more information, see “Using Operating Points in Stateflow” on page 17-2.

Use MAT-Files to Save a Operating Point for Future Use

To save an operating point from the MATLAB base workspace, save the variable with final state data in a MAT-file.

For example, type at the command prompt:

```
save('sf_car_ctx01.mat', 'sf_car_ctx01')
```

For more information, see `save` in the MATLAB documentation.

Use Scripts to Save Operating Point Commands for Future Use

To save a list of operating point commands for future use, copy them from a procedure and paste them in a MATLAB script.

For example, to reuse the commands in “Divide a Long Simulation into Segments” on page 17-4, you can store them in a script named `sf_boiler_operatingpoint_commands.m`:

```
% Open the model.
sf_boiler;

% Set parameters to save the operating point at the desired time.
set_param('sf_boiler','SaveFinalState','on','FinalStateName',...
'sf_boiler_ctx01','SaveOperatingPoint','on');

% Specify the start and stop times for the simulation segment.
set_param('sf_boiler','StartTime','0','StopTime','400');

% Simulate the model.
sim('sf_boiler');

% Disable saving of the operating point to avoid overwriting.
set_param('sf_boiler','SaveOperatingPoint','off', ...
'SaveFinalState','off');

% Load the operating point.
set_param('sf_boiler','LoadInitialState','on', ...
'InitialState','sf_boiler_ctx01');

% Specify the new stop time for the simulation segment.
set_param('sf_boiler','StopTime','600');
```

```
% Simulate the model.  
sim('sf_boiler');
```

The start time does not change, but the operating point restore fast forwards the simulation to the time of the snapshot.

See Also

More About

- “Using Operating Points in Stateflow” on page 17-2
- “Divide a Long Simulation into Segments” on page 17-4
- “Rules for Using the Operating Point of a Chart” on page 17-30

Vectors and Matrices in Stateflow Charts

- “Vectors and Matrices in Stateflow Charts” on page 18-2
- “Supported Operations for Vectors and Matrices” on page 18-4

Vectors and Matrices in Stateflow Charts

Vectors and matrices combine scalar data into a single, multidimensional data object. You can modify individual elements or perform arithmetic on entire vectors and matrices. For more information, see “Supported Operations for Vectors and Matrices” on page 18-4.

Define Vector and Matrix Data

- 1 Add a data object to your chart, as described in “Add Stateflow Data” on page 9-2.
- 2 Set the **Size** property for the data object as the dimensions of the vector or matrix. See “Specify Size of Stateflow Data” on page 9-33. For example:
 - To specify a 4-by-1 column vector, enter 4.
 - To specify a 1-by-4 row vector, enter [1 4].
 - To specify a 3-by-3 matrix, enter [3 3].
- 3 Set the **Initial value** property for the data object. See “Initial Value” on page 9-8.
 - To specify a value of zero for all elements of the vector or matrix, leave the **Initial value** empty. If you do not specify an initial value, all elements are initialized to 0.
 - To specify the same value for all elements of the vector or matrix, enter a scalar value. All elements are initialized to the scalar value you specify.
 - To specify a different value for each element of the vector or matrix, enter an array of real values. For example:
 - To initialize a 4-by-1 column vector, you can enter [1; 2; 3; 4].
 - To initialize a 1-by-4 row vector, you can enter [1 2 3 4].
 - To initialize a 3-by-3 matrix, you can enter [1 2 3; 4 5 6; 7 8 9].
- 4 Set the name, scope, base type, and other properties for the data object, as described in “Set Data Properties” on page 9-5.

You can specify the size and initial value of a vector or matrix by using an expression. Expressions can contain a mix of numeric values, constants, parameters, variables, arithmetic operations, and calls to MATLAB functions. For more information, see “Specify Data Properties by Using MATLAB Expressions” on page 9-16.

Where You Can Use Vectors and Matrices

You can define vectors and matrices at these levels of the Stateflow hierarchy:

- Charts
- Subcharts
- States
- Functions

You can use vectors and matrices to define:

- Input data
- Output data

- Local data
- Function inputs
- Function outputs

You can also use vectors and matrices as arguments for:

- State actions
- Transition actions
- MATLAB functions
- Truth table functions
- Graphical functions
- Simulink functions
- Change detection operators

Rules for Vectors and Matrices in Stateflow Charts

Use Operands of Equal Dimensions for Element-Wise Operations

If you perform element-wise operations on vectors or matrices with unequal dimensions, the chart generates a size mismatch error when you simulate the model. For more information, see “Supported Operations for Vectors and Matrices” on page 18-4.

Do Not Define Vectors and Matrices with the `ml` Base Type

The `ml` base type supports only scalar data. If you define a vector or matrix with the `ml` base type, the chart generates an error when you simulate the model. For more information, see “`ml` Data Type” on page 13-31.

Do Not Use Complex Numbers to Set the Initial Values of Vectors and Matrices

If you initialize an element of a vector or matrix by using a complex number, the chart generates an error when you simulate the model. You can set the values of vectors and matrices to complex numbers after initialization. For more information, see “Complex Data in Stateflow Charts” on page 24-2.

Do Not Use Vectors and Matrices in Temporal Logic Operators

Because time is a scalar quantity, you cannot use a vector or matrix as an argument for a temporal logic operator. For more information, see “Control Chart Execution by Using Temporal Logic” on page 13-40.



See Also

More About

- “Supported Operations for Vectors and Matrices” on page 18-4
- “Specify Size of Stateflow Data” on page 9-33
- “Reuse MATLAB Code by Defining MATLAB Functions” on page 29-2
- “Declare Variable-Size Data in Stateflow Charts” on page 19-2

Supported Operations for Vectors and Matrices

Stateflow charts in Simulink models have an action language property that defines the syntax that you use to compute with vectors and matrices. The action language properties are:

-  MATLAB as the action language.
-  C as the action language.

For more information, see “Differences Between MATLAB and C as Action Language Syntax” on page 14-5.

Indexing Notation

In charts that use MATLAB as the action language, refer to elements of a vector or matrix by using one-based indexing delimited by parentheses. Separate indices for different dimensions with commas.

In charts that use C as the action language, refer to elements of a vector or matrix by using zero-based indexing delimited by brackets. Enclose indices for different dimensions in their own pair of brackets.

Example	MATLAB as the Action Language	C as the Action Language
The first element of a vector V	$V(1)$	$V[0]$
The i^{th} element of a vector V	$V(i)$	$V[i-1]$
The element in row 4 and column 5 of a matrix M	$M(4,5)$	$M[3][4]$
The element in row i and column j of a matrix M	$M(i,j)$	$M[i-1][j-1]$

Binary Operations

This table summarizes the interpretation of all binary operations on vector and matrix operands according to their order of precedence (1 = highest, 3 = lowest). Binary operations are left associative so that, in any expression, operators with the same precedence are evaluated from left to right. Except for the matrix multiplication and division operators in charts that use MATLAB as the action language, all binary operators perform element-wise operations.

Operation	Precedence	MATLAB as the Action Language	C as the Action Language
$a * b$	1	Matrix multiplication.	Element-wise multiplication. For matrix multiplication, use the $*$ operation in a MATLAB function. See “Perform Matrix Arithmetic by Using MATLAB Functions” on page 18-7.
$a .* b$	1	Element-wise multiplication.	Not supported. Use the operation $a * b$.

Operation	Precedence	MATLAB as the Action Language	C as the Action Language
a / b	1	Matrix right division.	Element-wise right division. For matrix right division, use the $/$ operation in a MATLAB function. See “Perform Matrix Arithmetic by Using MATLAB Functions” on page 18-7.
$a ./ b$	1	Element-wise right division.	Not supported. Use the operation a / b .
$a \setminus b$	1	Matrix left division.	Not supported. Use the \setminus operation in a MATLAB function. See “Perform Matrix Arithmetic by Using MATLAB Functions” on page 18-7.
$a .\setminus b$	1	Element-wise left division.	Not supported. Use the $.\setminus$ operation in a MATLAB function. See “Perform Matrix Arithmetic by Using MATLAB Functions” on page 18-7.
$a + b$	2	Addition.	Addition.
$a - b$	2	Subtraction.	Subtraction.
$a == b$	3	Comparison, equal to.	Comparison, equal to.
$a ~= b$	3	Comparison, not equal to.	Comparison, not equal to.
$a != b$	3	Not supported. Use the operation $a ~= b$.	Comparison, not equal to.
$a <> b$	3	Not supported. Use the operation $a ~= b$.	Comparison, not equal to.

Unary Operations and Actions

This table summarizes the interpretation of all unary operations and actions on vector and matrix operands. Unary operations:

- Have higher precedence than the binary operators.
- Are right associative so that, in any expression, they are evaluated from right to left.
- Perform element-wise operations.

Example	MATLAB as the Action Language	C as the Action Language
$\sim a$	Logical NOT. For bitwise NOT, use the <code>bitcmp</code> function.	<ul style="list-style-type: none"> • Bitwise NOT (default). Enable this operation by selecting the Enable C-bit operations chart property. • Logical NOT. Enable this operation by clearing the Enable C-bit operations chart property. <p>For more information, see “Bitwise Operations” on page 13-17 and “Enable C-Bit Operations” on page 25-4.</p>

Example	MATLAB as the Action Language	C as the Action Language
!a	Not supported. Use the operation ~a.	Logical NOT.
-a	Negative.	Negative.
a++	Not supported.	Increment all elements of the vector or matrix. Equivalent to $a = a+1$.
a--	Not supported.	Decrement all elements of the vector or matrix. Equivalent to $a = a-1$.

Assignment Operations

This table summarizes the interpretation of assignment operations on vector and matrix operands.

Operation	MATLAB as the Action Language	C as the Action Language
a = b	Simple assignment.	Simple assignment.
a += b	Not supported. Use the expression $a = a + b$.	Equivalent to $a = a+b$.
a -= b	Not supported. Use the expression $a = a - b$.	Equivalent to $a = a-b$.
a *= b	Not supported. Use the expression $a = a*b$.	Equivalent to $a = a*b$.
a /= b	Not supported. Use the expression $a = a/b$.	Equivalent to $a = a/b$.

Assign Values to Individual Elements of a Matrix

You can assign a value to an individual entry of a vector or matrix by using the indexing syntax appropriate to the action language of the chart.

Example	MATLAB as the Action Language	C as the Action Language
Assign the value 10 to the first element of the vector V.	$V(1) = 10;$	$V[0] = 10;$
Assign the value 77 to the element in row 2 and column 9 of the matrix M.	$M(2,9) = 77;$	$M[1][8] = 77;$

Assign Values to All Elements of a Matrix

In charts that use MATLAB as the action language, you can use a single action to specify all of the elements of a vector or matrix. For example, this action assigns each element of the 2-by-3 matrix A to a different value:

$A = [1 \ 2 \ 3; \ 4 \ 5 \ 6];$

In charts that use C as the action language, you can use scalar expansion to set all of the elements of a vector or matrix to the same value. Scalar expansion converts scalar data to match the dimensions of vector or matrix data. For example, this action sets all of the elements of the matrix A to 10:

$A = 10;$

Scalar expansion applies to all graphical, truth table, MATLAB, and Simulink functions. Suppose that you define the formal arguments of a function f as scalars. This table describes the rules of scalar expansion for the function call $y = f(u)$.

Output y	Input u	Result
Scalar	Scalar	No scalar expansion occurs.
Scalar	Vector or matrix	The chart generates a size mismatch error.
Vector or matrix	Scalar	The chart uses scalar expansion to assign the scalar output value of $f(u)$ to every element of y : $y[i][j] = f(u)$
Vector or matrix	Vector or matrix	The chart uses scalar expansion to compute an output value for each element of u and assign it to the corresponding element of y : $y[i][j] = f(u[i][j])$ If y and u do not have the same size, the chart generates a size mismatch error.

For functions with multiple outputs, the same rules apply unless the outputs and inputs are all vectors or matrices. In this case, the chart generates a size mismatch error and scalar expansion does not occur.

Charts that use MATLAB as the action language do not support scalar expansion.

Perform Matrix Arithmetic by Using MATLAB Functions

In charts that use C as the action language, the operations $*$ and $/$ perform element-wise multiplication and division. To perform standard matrix multiplication and division in a C chart, use a MATLAB function.

Suppose that you want to perform these operations on the square matrices $u1$ and $u2$:

- Compute the standard matrix product $y1 = u1 * u2$.
- Solve the equation $u1 * y2 = u2$.
- Solve the equation $y3 * u1 = u2$.

To complete these calculations in a C chart, add a MATLAB function that runs this code:

```
function [y1, y2, y3] = my_matrix_ops(u1, u2)
%#codegen

y1 = u1 * u2; % matrix multiplication
y2 = u1 \ u2; % matrix division from the right
y3 = u1 / u2; % matrix division from the left
```

Before calling the function, specify the properties for the input and output data, as described in “Set Data Properties” on page 9-5.

In charts that use MATLAB as the action language, the operations $*$, $/$, and \backslash perform standard matrix multiplication and division. You can use these operations directly in state and transition actions.

See Also

More About

- “Vectors and Matrices in Stateflow Charts” on page 18-2
- “Specify Size of Stateflow Data” on page 9-33

Variable-Size Data in Stateflow Charts

- “Declare Variable-Size Data in Stateflow Charts” on page 19-2
- “Compute Output Based on Size of Input Signal” on page 19-5

Declare Variable-Size Data in Stateflow Charts

Variable-size data is data whose size can change at run time. In contrast, fixed-size data is data whose size is known and locked at compile time and does not change at run time. Use variable-size data if the output from a Stateflow chart in a Simulink model is an array whose size depends on the state of the chart.

Stateflow charts exchange variable-size data with other charts and blocks in their models through MATLAB functions, Simulink functions, and truth tables that use MATLAB as the action language. You pass variable-size data to these functions as chart-level inputs and outputs from state actions and transition logic. However, you must perform all computations with variable-size data inside the functions, not directly in states or transitions. For more information about the functions that interact with variable-size, chart-level inputs and outputs, see:

- “Reuse MATLAB Code by Defining MATLAB Functions” on page 29-2
- “Reuse Simulink Components in Stateflow Charts” on page 30-2
- “Use Truth Tables to Model Combinatorial Logic” on page 28-2

Enable Support for Variable-Size Data

Support for variable-size data is enabled by default. To modify this option for individual charts:

- 1 Right-click an open area of the chart and select **Properties**.
- 2 In the Chart properties dialog box, select or clear the **Support variable-size arrays** check box.

After enabling support at the chart level, you can declare variable-size inputs and outputs.

Declare Variable-Size Inputs and Outputs

- 1 Add a data object to the chart, as described in “Add Stateflow Data” on page 9-2.
- 2 Set **Scope** property as Input or Output.
- 3 Select the **Variable size** check box.
- 4 Set the **Size** property for the data.

Scope	What to Specify
Input	Enter -1 to inherit size from Simulink or specify the explicit size and upper bound.
Output	Specify the explicit size and upper bound.

For example, this specification declares a variable-size input **data** that inherits its **Size** and **Type** from the Simulink model. To specify a 2-D matrix where the upper bounds are 2 for the first dimension and 4 for the second dimension, in the **Size** field, enter [2 4] instead.

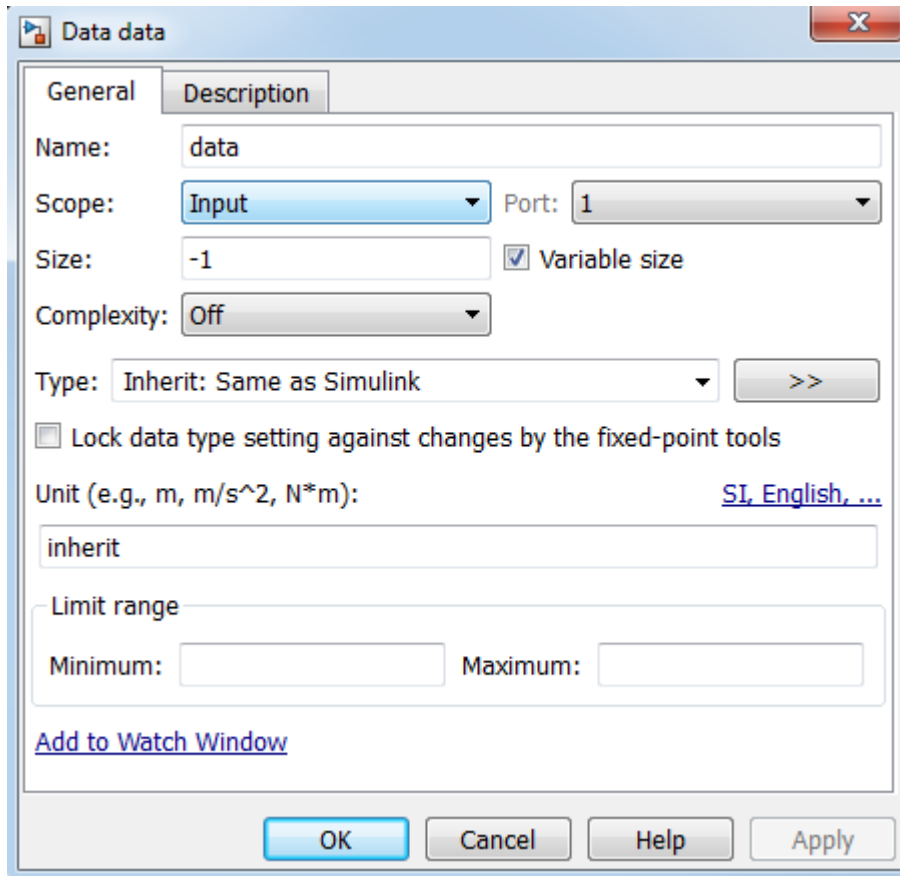

Rules for Using Variable-Size Data

- Declare variable-size data as chart inputs and outputs only, not as local data.

See “Declare Variable-Size Inputs and Outputs” on page 19-2.

- Do not perform computations with variable-size data directly in states or transitions.
- Perform all computations with variable-size data in MATLAB functions, Simulink functions, and truth tables that use MATLAB as the action language.

You can pass the data as inputs and outputs to MATLAB and Simulink functions in your chart from state actions and transition logic. MATLAB functions can also access the chart-level, variable-size data directly. For more information, see “Compute Output Based on Size of Input Signal” on page 19-5.

See Also

More About

- “Compute Output Based on Size of Input Signal” on page 19-5
- “Reuse MATLAB Code by Defining MATLAB Functions” on page 29-2
- “Reuse Simulink Components in Stateflow Charts” on page 30-2

- “Use Truth Tables to Model Combinatorial Logic” on page 28-2

Compute Output Based on Size of Input Signal

This example shows how to modify the size of output data in a Stateflow® chart during run time. Stateflow charts exchange variable-size data with other charts and blocks in the model through MATLAB® functions, Simulink® functions, and MATLAB truth tables. This example illustrates this process by using MATLAB functions in two Stateflow charts.

In this model, one Stateflow chart, `VarSizeSignalSource`, uses temporal logic to generate a variable-size signal. A second chart, `SizeBasedProcessing`, computes the output based on the size of the signal generated by the first chart.

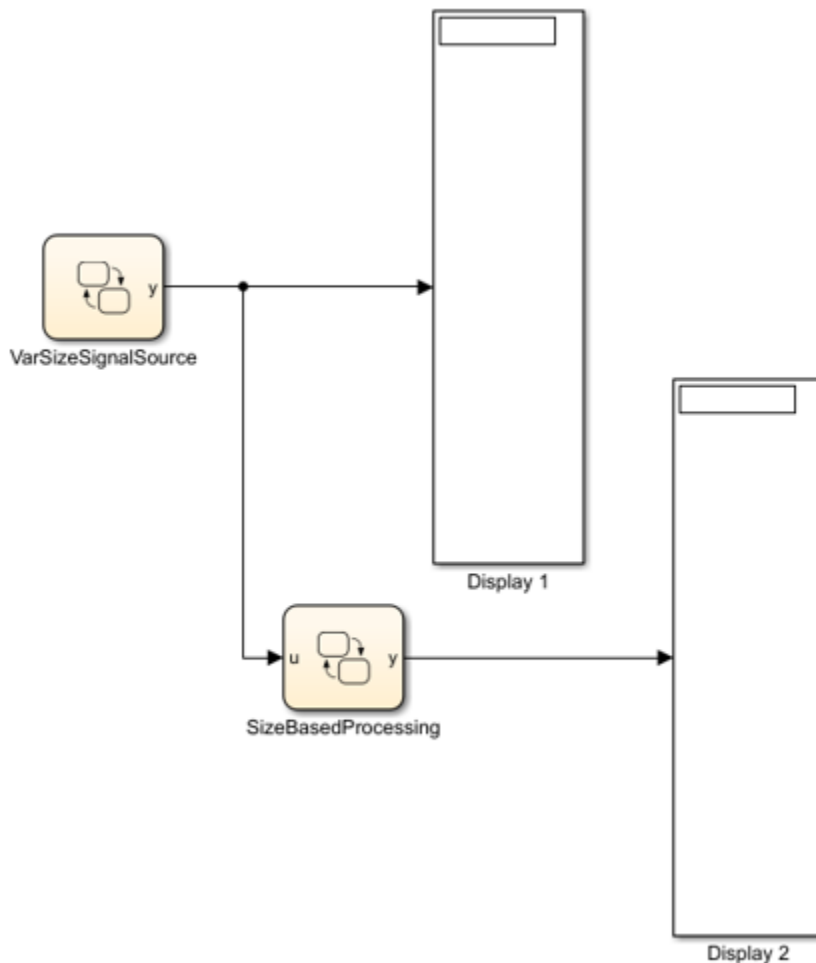

VarSizeSignalSource Chart

The `VarSizeSignalSource` chart uses temporal logic to transition between three states. Each state generates a different size output.

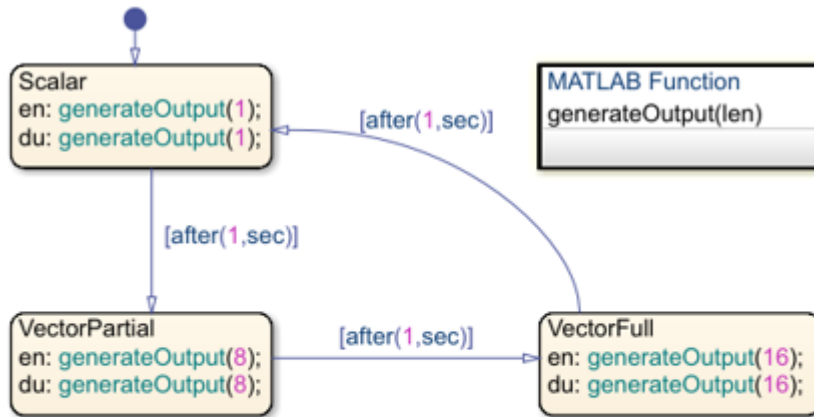

Use this Stateflow chart to generate an output signal with a variable size. In this chart, each state calls a MATLAB function that assigns to the chart output a different-size signal (within the bounds). During simulation, transitions between states change the size of the signal. You can use this variable-size signal to test other blocks and subsystems in your model.

The chart works like a source block. It has no input and one variable-size output y.

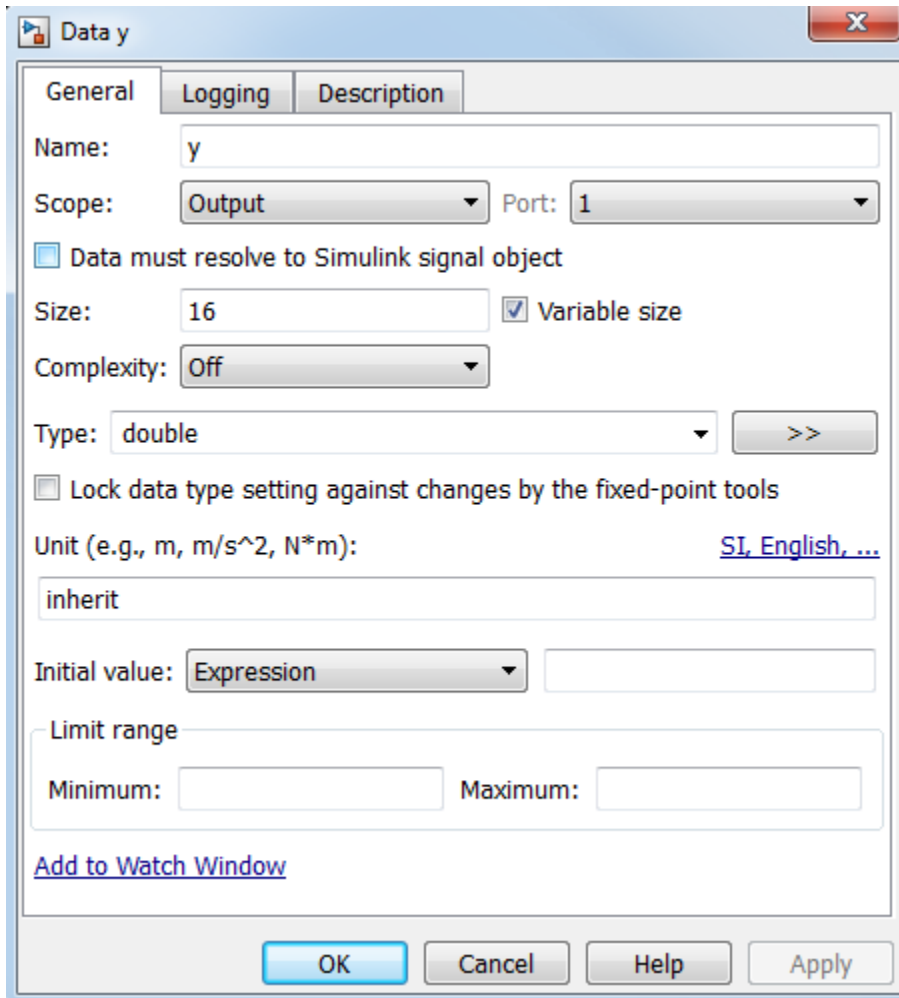

For variable-size outputs, you must explicitly specify the size and upper bound for each dimension. In this case, `y` is a vector whose length has an upper bound of 16.

Because states or transitions cannot read from or write to variable-size data, `y` does not appear in any state actions or transition logic. All computations involving variable-size data must occur in MATLAB functions in the chart.

MATLAB Function: `generateOutput`

MATLAB functions access variable-size, chart-level data directly. You do not pass the data as inputs or outputs to the functions. In this chart, the `generateOutput` function constructs the variable-size output vector `y` as a number sequence based on the input it receives.

```
function generateOutput(len)
%#codegen
assert(len<=16);
y = (1:len)';
```

MATLAB functions must be able to determine the upper bounds of variable-size data at compile time. In this case, however, the upper bound is `len`, an input for which the model computes the value at run time. To provide this information, the `assert` function specifies an explicit upper bound for `len` that matches the upper bound specified for the chart output `y`.

SizeBasedProcessing Chart

The SizeBasedProcessing chart uses three MATLAB functions to compute a variable-size output y based on the value of a variable-size input u .

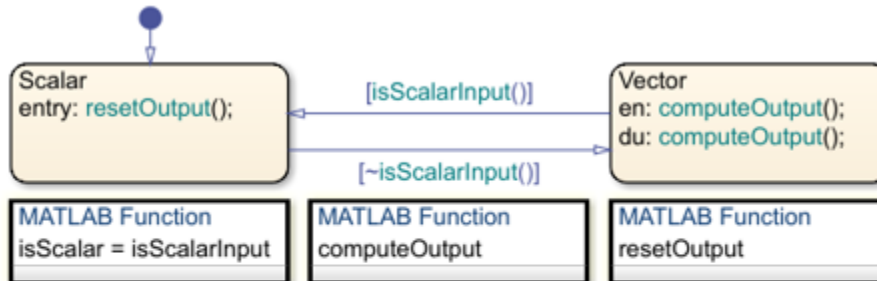

In this chart, MATLAB functions:

- Determine the size of the input signal.
- Use MATLAB syntax to compute variable-size outputs based on inputs.
- Reset the output to zero when the input is scalar.

Key behavior:

- * Variable-size data is allowed only for chart input and output data.
- * Variable-size data "u" and "y" do not appear in state actions or on transitions.
- * MATLAB functions access variable-size data "u" and "y" directly for computations.
- * MATLAB functions do not use variable dimensions for their own input and output data.

- Input u is the variable-size signal generated by the VarSizeSignalSource chart.

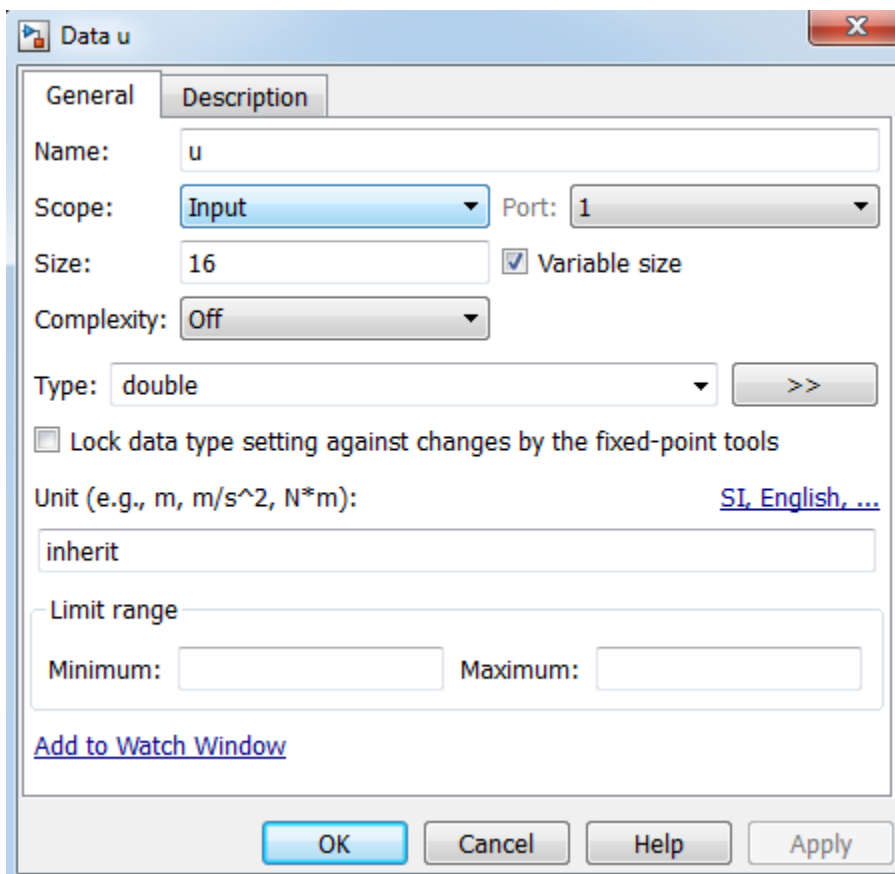

- Output y is a variable-size signal whose size depends on whether u is a scalar or vector.

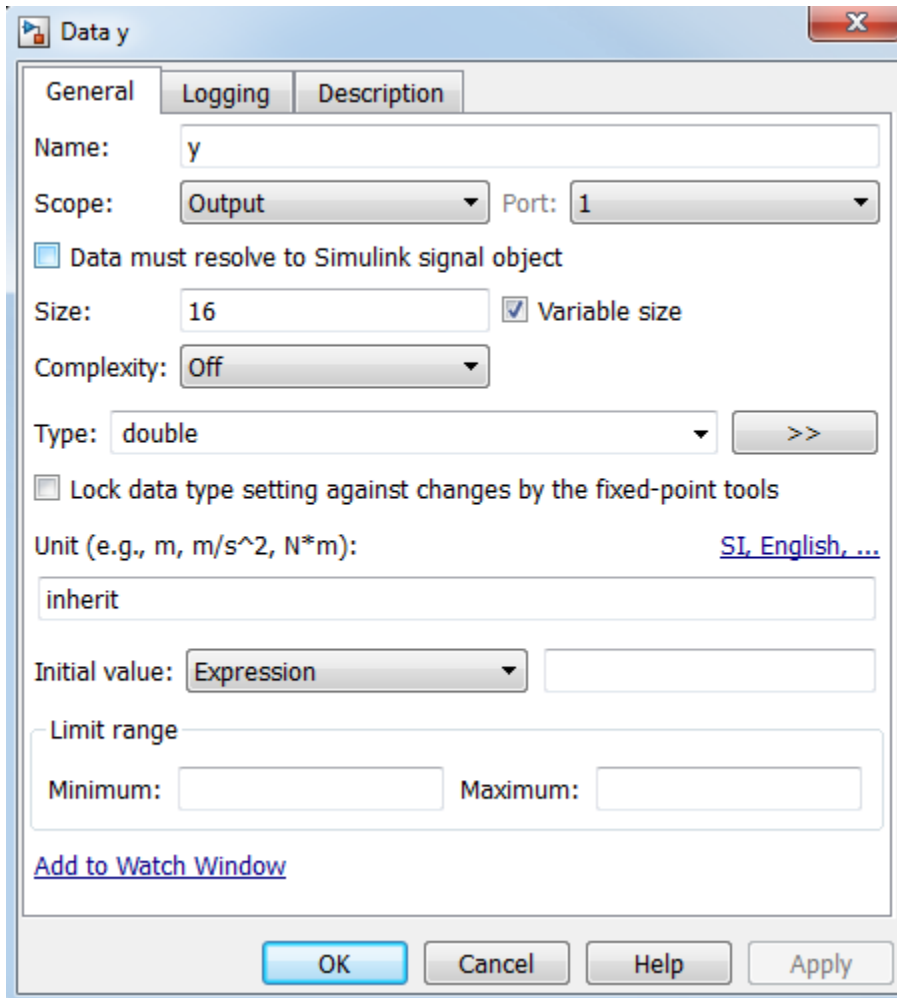

As in the chart `VarSizeSignalSource`, variable-size data does not appear in state actions or transition logic. Instead, states call MATLAB functions to compute the variable-size output. Transitions call a MATLAB function in a conditional statement to evaluate the variable-size input.

MATLAB Function: `isScalarInput`

This function tests whether chart input u , the signal generated by chart `VarSizeSignalSource`, is a scalar or vector value:

```
function isScalar = isScalarInput
%#codegen
isScalar = length(u)==1;
```

MATLAB Function: `computeOutput`

If input u is a vector, this function outputs the sine of each of its values:

```
function computeOutput
%#codegen
y = sin(u);
```

MATLAB Function: resetOutput

If input `u` is a scalar, this function outputs a value of zero:

```
function resetOutput
%#codegen
y = 0;
```

Simulate the Model

- 1 Open the model. The tabs along the top of the Editor canvas enable you to switch between the Simulink model and the two Stateflow charts.
- 2 Start simulation from the `VarSizeSignalSource` chart. The chart animation shows the active state cycling between the `Scalar`, `VectorPartial`, and `VectorFull` states.
- 3 Change tabs to view the `SizeBasedProcessing` chart. The chart animation shows the active state alternating between the `Scalar` and `Vector` states.
- 4 Change tabs to return to the Simulink model. The display blocks periodically show 1, 8, and 16 values from the variable-size vectors.

See Also**More About**

- “Declare Variable-Size Data in Stateflow Charts” on page 19-2

Enumerated Data in Charts

- “Reference Values by Name by Using Enumerated Data” on page 20-2
- “Define Enumerated Data Types” on page 20-5
- “Best Practices for Using Enumerated Data” on page 20-8
- “Assign Enumerated Values in a Chart” on page 20-11

Reference Values by Name by Using Enumerated Data

To enhance the readability of a Stateflow chart, use enumerated data. With enumerated data, you can:

- Create a restricted set of values and refer to those values by name.
- Group related values into separate data types.
- Avoid defining a long list of constants.

Enumerated data is supported in Stateflow charts in Simulink models.

Example of Enumerated Data

An enumerated data type is a finite collection of *enumerated values* consisting of a name and an underlying integer value. For example, this chart uses enumerated data to refer to a set of colors.

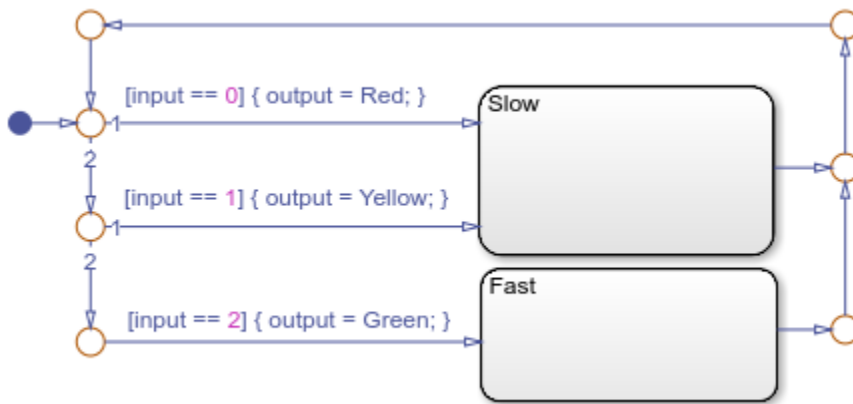

The enumerated data output is restricted to a finite set of values. You can refer to these values by their names: Red, Yellow, and Green.

Enumerated Value	Name	Integer Value
Red(0)	Red	0
Yellow(1)	Yellow	1
Green(2)	Green	2

This MATLAB file defines the enumerated data type BasicColors referenced by the chart.

```
classdef BasicColors < Simulink.IntEnumType
    enumeration
        Red(0)
        Yellow(1)
        Green(2)
    end
end
```

Computation with Enumerated Data

An enumerated data type does not function as a numeric type despite the existence of the underlying integer values. You cannot use enumerated values directly in a mathematical computation. You can

use enumerated data to control chart behavior based on assignments and comparisons. To assign or compare enumerated data, use the operations listed in this table.

Example	Description
<code>a = exp</code>	Assignment of <code>exp</code> to <code>a</code> . <code>exp</code> must evaluate to an enumerated value.
<code>a == b</code>	Comparison, equality.
<code>a != b</code>	Comparison, inequality.

In a chart that uses C as the action language, you can compare enumerated data with different data types. Before the comparison, the chart casts the enumerated data to their underlying integer values.

Charts that use MATLAB as the action language cannot compare enumerated data with different data types.

Notation for Enumerated Values

To refer to an enumerated value, use prefixed or nonprefixed identifiers.

Prefixed Identifiers

To prevent name conflicts when referring to enumerated values in Stateflow charts, you can use prefixed identifiers of the form *Type.Name*. *Type* is an enumerated data type and *Name* is an enumerated value name. For example, suppose that you define three data types (`Colors`, `Temp`, and `Code`) that contain the enumerated name `Red`. By using prefixed notation, you can distinguish `Colors.Red` from `Temp.Red` and `Code.Red`.

Nonprefixed Identifiers

To minimize identifier length when referring to unique enumerated values, you can use nonprefixed enumerated value names. For example, suppose that the enumerated name `Red` belongs only to the data type `Colors`. You can then refer to this value with the nonprefixed identifier `Red`.

If your chart uses data types that contain identical enumerated names (such as `Colors.Red` and `Temp.Red`), use prefixed identifiers to prevent name conflicts.

Where to Use Enumerated Data

Use enumerated data at these levels of the Stateflow hierarchy:

- Chart
- Subchart
- State

Use enumerated data as arguments for:

- State actions
- Condition and transition actions
- Vector and matrix indexing
- MATLAB functions

- Graphical functions
- Simulink functions
- Truth Table blocks and truth table functions

If you have Simulink Coder installed, you can use enumerated data for simulation and code generation.

See Also

More About

- “Define Enumerated Data Types” on page 20-5
- “Assign Enumerated Values in a Chart” on page 20-11
- “Best Practices for Using Enumerated Data” on page 20-8
- “Simulink Enumerations” (Simulink)
- “Use Enumerated Data in Simulink Models” (Simulink)

Define Enumerated Data Types

To enhance the readability of a Stateflow chart, use enumerated data. With enumerated data, you can:

- Create a restricted set of values and refer to those values by name.
- Group related values into separate data types.
- Avoid defining a long list of constants.

Enumerated data is supported in Stateflow charts in Simulink models. For more information, see “Reference Values by Name by Using Enumerated Data” on page 20-2.

Before you can add enumerated data to a Stateflow chart, you must define an enumerated data type in a MATLAB class definition file. Create a different file for each enumerated type.

Elements of an Enumerated Data Type Definition

The enumerated data type definition consists of three sections of code.

Section of Code	Required?	Purpose
<code>classdef</code>	Yes	Provides the name of the enumerated data type
<code>enumeration</code>	Yes	Lists the enumerated values that the data type allows
<code>methods</code>	No	Provides methods that customize the data type

Define an Enumerated Data Type

- 1 Open a new file in which to store the data type definition. From the **Home** tab on the MATLAB toolstrip, select **New > Class**.
- 2 Complete the `classdef` section of the definition.

```
classdef BasicColors < Simulink.IntEnumType
    ...
end
```

The `classdef` section defines an enumerated data type with the name `BasicColors`. Stateflow derives the data type from the built-in type `Simulink.IntEnumType`. The enumerated data type name must be unique among data type names and workspace variable names.

- 3 Define enumerated values in an `enumeration` section.

```
classdef BasicColors < Simulink.IntEnumType
    enumeration
        Red(0)
        Yellow(1)
        Green(2)
    end
end
```

An enumerated type can define any number of values. The `enumeration` section lists the set of enumerated values that this data type allows. Each enumerated value consists of a name and an underlying integer value. Each name must be unique within its type, but can also appear in other

enumerated types. The default value is the first one in the list, unless you specify otherwise in the methods section of the definition.

- 4 (Optional) Customize the data type by using a methods section. The section can contain these methods:
- `getDefaultValue` specifies a default enumerated value other than the first one in the list of allowed values.
 - `getDescription` specifies a description of the data type for code generated by Simulink Coder.
 - `getHeaderFile` specifies custom header file that contains the enumerated type definition in code generated by Simulink Coder.
 - `getDataScope` enables exporting or importing the enumerated type definition to or from a header file in code generated by Simulink Coder.
 - `addClassNameToEnumNames` enhances readability and prevents name conflicts with identifiers in code generated by Simulink Coder.

For example, this MATLAB file presents a customized definition for the enumerated data type `BasicColors` that:

- Specifies that the default enumerated value is the last one in the list of allowed values.
- Includes a short description of the data type for code generated by Simulink Coder.
- Imports the definition of the data type from a custom header file to prevent Simulink Coder from generating the definition.
- Adds the name of the data type as a prefix to each enumeration member name in code generated by Simulink Coder.

```
classdef BasicColors < Simulink.IntEnumType
    enumeration
        Red(0)
        Yellow(1)
        Green(2)
    end

    methods (Static = true)
        function retVal = getDefaultValue()
            % GETDEFAULTVALUE Specifies the default enumeration member.
            % Return a valid member of this enumeration class to specify the default.
            % If you do not define this method, Simulink uses the first member.
            retVal = BasicColors.Green;
        end

        function retVal = getDescription()
            % GETDESCRIPTION Specifies a string to describe this enumerated type.
            retVal = 'This defines an enumerated type for colors';
        end

        function retVal = getHeaderFile()
            % GETHEADERFILE Specifies the file that defines this type in generated code.
            % The method getDataScope determines the significance of the specified file.
            retVal = 'imported_enum_type.h';
        end

        function retVal = getDataScope()
```

```

    % GETDATASCOPE Specifies whether generated code imports or exports this type.
    % Return one of these strings:
    % 'Auto':    define type in model_types.h, or import if header file specified
    % 'Exported': define type in a generated header file
    % 'Imported': import type definition from specified header file
    % If you do not define this method, DataScope is 'Auto' by default.
    retVal = 'Imported';
end

function retVal = addClassNameToEnumNames()
    % ADDCLASSNAMETOENUMNAMES Specifies whether to add the class name
    % as a prefix to enumeration member names in generated code.
    % Return true or false.
    % If you do not define this method, no prefix is added.
    retVal = true;
end % function
end % methods
end % classdef

```

- 5 Save the file on the MATLAB path. The name of the file must match exactly the name of the data type. For example, the definition for the data type `BasicColors` must reside in a file named `BasicColors.m`.

Tip To add a folder to the MATLAB search path, type `addpath pathname` at the command prompt.

Specify Data Type in the Property Inspector

When you add enumerated data to your chart, specify its type in the Property Inspector.

- 1 In the **Type** field, select Enum: <class name>.
- 2 Replace <class name> with the name of the data type. For example, you can enter Enum: `BasicColors` in the **Type** field.
- 3 (Optional) Enter an initial value for the enumerated data by using a prefixed identifier. The initial value must evaluate to a valid MATLAB expression.

See Also

More About

- “Assign Enumerated Values in a Chart” on page 20-11
- “Best Practices for Using Enumerated Data” on page 20-8
- “Use Enumerated Data in Simulink Models” (Simulink)
- “Customize Simulink Enumeration” (Simulink)

Best Practices for Using Enumerated Data

To enhance the readability of a Stateflow chart, use enumerated data. With enumerated data, you can:

- Create a restricted set of values and refer to those values by name.
- Group related values into separate data types.
- Avoid defining a long list of constants.

Enumerated data is supported in Stateflow charts in Simulink models. For more information, see “Reference Values by Name by Using Enumerated Data” on page 20-2.

Guidelines for Defining Enumerated Data Types

Use Unique Name for Each Enumerated Type

To avoid name conflicts, the name of an enumerated data type cannot match the name of:

- Another data type
- A data object in the Stateflow chart
- A variable in the MATLAB base workspace

Use Same Name for Enumerated Type and Class Definition File

To enable resolution of enumerated data types for Simulink models, the name of the MATLAB file that contains the type definition must match the name of the data type.

Apply Changes in Enumerated Type Definition

When you update an enumerated data type definition for an open model, the changes do not take effect immediately. To see the effects of updating a data type definition:

- 1 Save and close the model.
- 2 Delete all instances of the data type from the MATLAB base workspace. To find these instances, type `whos` at the command prompt.
- 3 Open the model and start simulation or generate code by using Simulink Coder.

Guidelines for Referencing Enumerated Data

Ensure Unique Name Resolution for Nonprefixed Identifiers

If you use nonprefixed identifiers to refer to enumerated values in a chart, ensure that each enumerated name belongs to a unique enumerated data type.

Use Unique Identifiers for Enumerated Values

If an enumerated value uses the same identifier as a data object or a bus field, the chart does not resolve the identifier correctly. For example, this diagram shows the stages in which a chart tries to resolve the identifier `Colors.Red`.

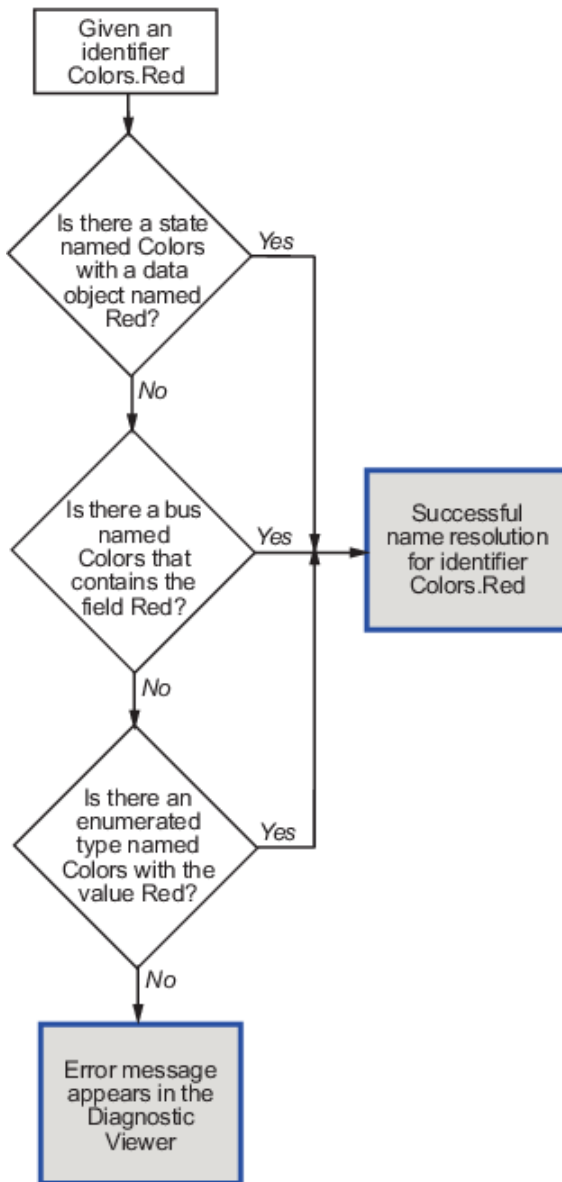

Set Initial Values of Enumerated Data by Using Prefixed Identifiers

If you choose to set an initial value for enumerated data, you must use a prefixed identifier in the **Initial value** field of the Property Inspector. For example, `BasicColors.Red` is a valid identifier, but `Red` is not. The initial value must evaluate to a valid MATLAB expression.

Enhance Readability of Generated Code by Using Prefixed Identifiers

If you add prefixes to enumerated names in the generated code, you enhance readability and avoid name conflicts with global symbols. For details, see "Use Enumerated Data in Generated Code" (Simulink Coder).

Guidelines and Limitations for Enumerated Data

Do Not Enter Minimum or Maximum Values for Enumerated Data

For enumerated data, leave the **Minimum** and **Maximum** fields of the Property Inspector empty. The chart ignores any values that you enter in these fields.

Whether these fields appear in the Property Inspector depends on which **Type** field option you use to define enumerated data.

Type Field Option	Appearance of the Minimum and Maximum Fields
Enum: <class name>	Not available
<data type expression> or Inherit from Simulink	Available

Do Not Assign Enumerated Values to Constant Data

Because enumerated values are constants, assigning these values to constant data is redundant and unnecessary. If you try to assign enumerated values to constant data, an error appears.

Do Not Use m1 Namespace Operator to Access Enumerated Data

The m1 operator does not support enumerated data.

Do Not Define Enumerated Data at Machine Level of Hierarchy

Machine-parented data is not supported for enumerated types.

See Also

More About

- “Reference Values by Name by Using Enumerated Data” on page 20-2
- “Define Enumerated Data Types” on page 20-5
- “Assign Enumerated Values in a Chart” on page 20-11

Assign Enumerated Values in a Chart

To enhance the readability of a Stateflow chart, use enumerated data. With enumerated data, you can:

- Create a restricted set of values and refer to those values by name.
- Group related values into separate data types.
- Avoid defining a long list of constants.

Enumerated data is supported in Stateflow charts in Simulink models. For more information, see “Reference Values by Name by Using Enumerated Data” on page 20-2.

Chart Behavior

This example shows how to build a chart that uses enumerated values to issue a status keyword.

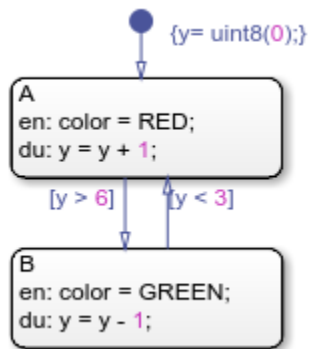

During simulation, the chart action alternates between states A and B.

Execution of State A

- At the start of the simulation, state A is entered.
- State A executes the entry action by assigning the value RED to the enumerated data color.
- The data y increments once per time step (every 0.2 seconds) until the condition [y > 6] is true.
- The chart takes the transition from state A to state B.

Execution of State B

- After the transition from state A occurs, state B is entered.
- State B executes the entry action by assigning the value GREEN to the enumerated data color.
- The data y decrements once per time step (every 0.2 seconds) until the condition [y < 3] is true.
- The chart takes the transition from state B back to state A.

Build the Chart

Add States and Transitions to the Chart

- 1 To create a Simulink model with an empty chart, at the MATLAB command prompt, enter `sfnew`.
- 2 In the empty chart, add states A and B. At the text prompt, enter the appropriate action statements.
- 3 Add a default transition to state A and transitions between states A and B.
- 4 Double-click each transition. At the text prompt, enter the appropriate condition.

Define an Enumerated Data Type for the Chart

- 1 To create a file in which to store the data type definition, from the **Home** tab on the MATLAB toolstrip, select **New > Class**.
- 2 In the MATLAB Editor, enter:

```
classdef TrafficColors < Simulink.IntEnumType
    enumeration
        RED(0)
        GREEN(10)
    end
end
```

The `classdef` section defines an integer-based enumerated data type named `TrafficColors`. The `enumeration` section contains the enumerated values that this data type allows followed by their underlying numeric value.

- 3 Save your file as `TrafficColors.m` in a folder on the MATLAB search path.

Define Chart Data

- 1 To resolve the undefined data, in the Symbols pane, click the **Resolve undefined symbols** icon . The Stateflow Editor assigns an appropriate scope to each symbol in the chart.

Symbol	Scope
color	Output Data
y	Local Data
GREEN	Parameter Data
RED	Parameter Data

- 2 To specify `color` as enumerated data, in the Property Inspector:
 - In the **Type** field, select Enum: `<class name>`. Replace `<class name>` with `TrafficColors`, the name of the data type that you defined previously.
 - Under **Logging**, select the **Log signal data** check box.
- 3 To set the scope and type of `y`, in the Property Inspector:
 - In the **Scope** field, select Output.
 - In the **Type** field, select `uint8`.
 - Under **Logging**, select the **Log signal data** check box.

- 4 In the Symbols pane, delete the symbols GREEN and RED. The Stateflow Editor incorrectly identified these symbols as parameters before you specified color as enumerated data.

View Simulation Results

- 1 When you simulate the model, the **Simulation Data Inspector** icon  is highlighted to indicate that it has new simulation data. To open the Simulation Data Inspector, click the icon.
- 2 In the Simulation Data Inspector, select the check boxes for the color and y signals so that they are displayed on separate axes.

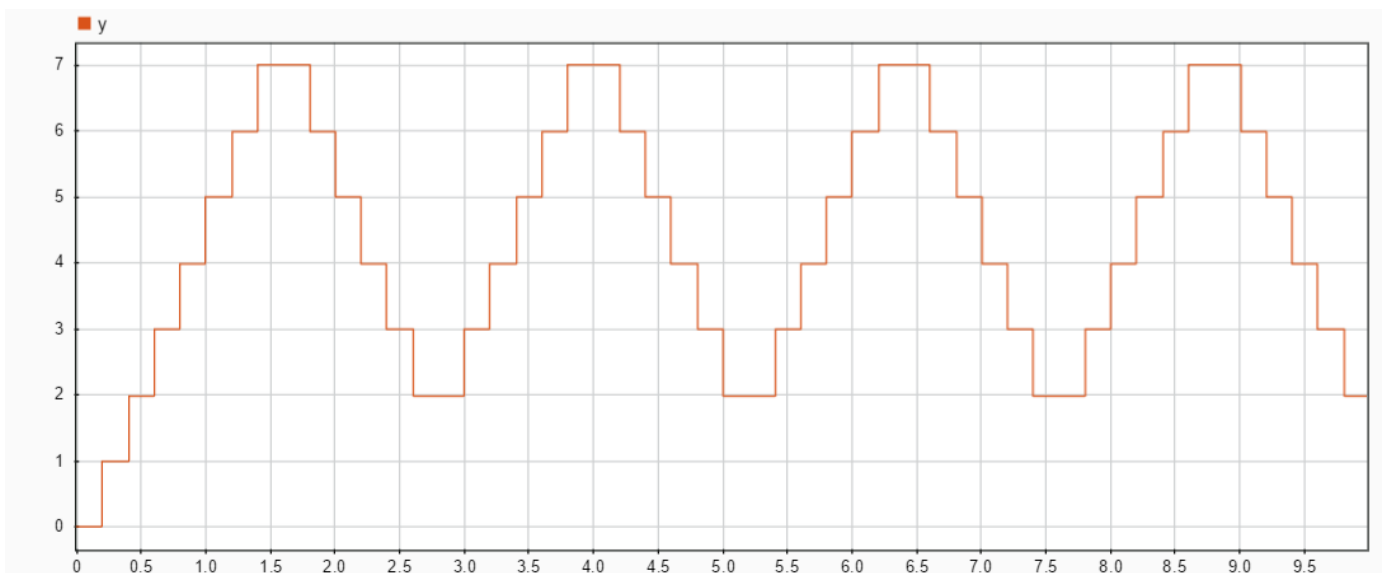
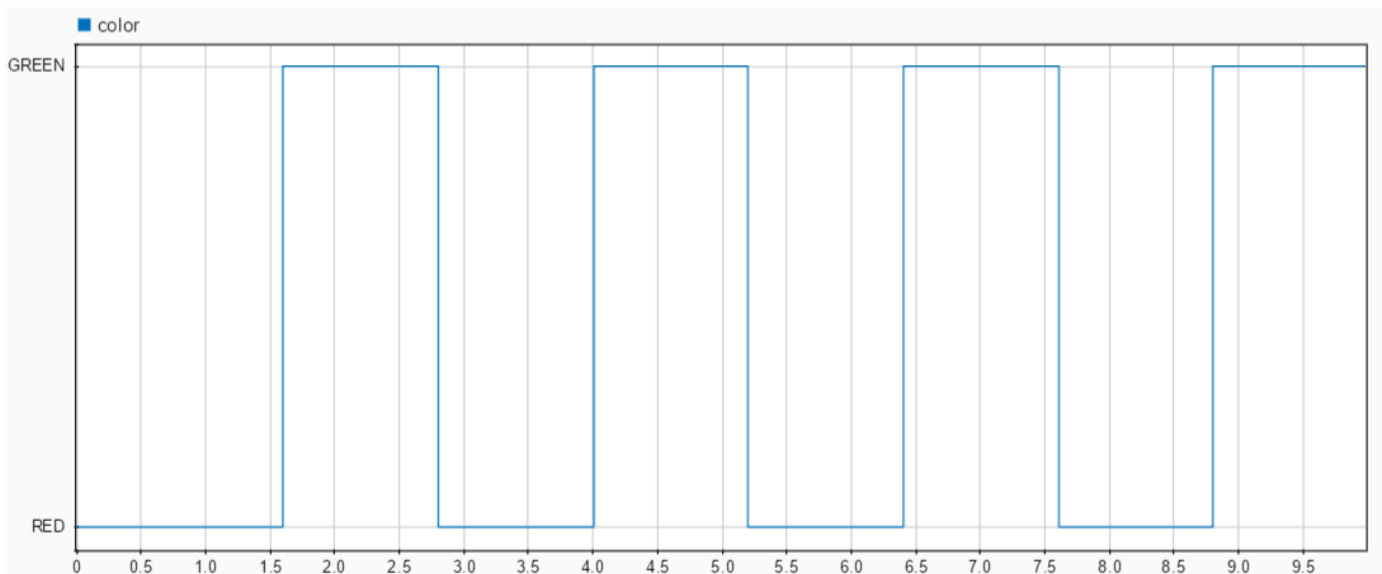

- 3 To access the logged data in the MATLAB workspace, call the signal logging object `logout`. For example, at the command prompt, enter:

```
logout = out.logout;  
colorLog = logout.getElement('color');  
Tbl = table(colorLog.Values.Time,colorLog.Values.Data);  
Tbl.Properties.VariableNames = {'SimulationTime','Color'}
```

Tbl =

9x2 table

SimulationTime	Color
0	RED
1.6	GREEN
2.8	RED
4	GREEN
5.2	RED
6.4	GREEN
7.6	RED
8.8	GREEN
10	RED

See Also

More About

- “Define Enumerated Data Types” on page 20-5
- “Log Simulation Output for States and Data” on page 33-45
- “View Data with the Simulation Data Inspector” (Simulink)
- “Export Signal Data Using Signal Logging” (Simulink)

String Data in Charts

- “Manage Textual Information by Using Strings” on page 21-2
- “Log String Data to the Simulation Data Inspector” on page 21-6
- “Send Messages with String Data” on page 21-10
- “Share String Data with Custom C Code” on page 21-13
- “Simulate a Media Player by Using Strings” on page 21-17

Manage Textual Information by Using Strings

To use textual data to control chart behavior and to manipulate text to create natural language output, use *strings*. String data is available only in Stateflow charts that use C as the action language.

Example of String Data

In Stateflow, a string is a piece of text surrounded by quotes ("..." or '...'). For example, this chart takes string data as input. Based on that input, the chart produces a corresponding string output.

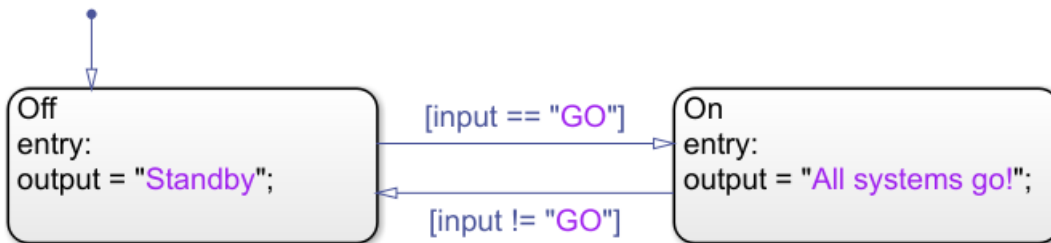

To specify a string symbol, set its **Type** field to `string`. Stateflow dynamically allocates memory space for this type of data.

Alternatively, you can create string data with a maximum number of characters. To specify a string symbol with a buffer size of n characters, set its **Type** field to `stringtype(n)`. The text of the string can be shorter than the buffer, but if it exceeds the buffer size, then the text in the string is truncated. For instance, if the symbol `output` in the previous chart is specified as `stringtype(10)`, then its value in the state `On` is truncated to `"All system"`. Depending on the configuration parameter **String truncation checking**, you can halt simulation and diagnose truncation of string data.

String Truncation Checking	Description
error	Simulation stops with an error.
warning	String is truncated. Simulation continues with a warning.
none	String is truncated. Simulation continues with no error or warning.

Note Unlike C or C++, Stateflow interprets escape sequences as literal characters. For example, the string `"\n"` contains two characters, backslash and `n`, and not a newline character.

Computation with Strings

To manipulate string data in a Stateflow chart, use the operators listed in this table.

Operator	Syntax	Description	Example
<code>strcpy</code>	<code>dest = src</code>	Assigns string <code>src</code> to <code>dest</code> .	Assign string data to <code>s1</code> and <code>s2</code> . <code>s1 = 'hello';</code> <code>s2 = "good bye";</code>

Operator	Syntax	Description	Example
	<code>strcpy(dest,src)</code>	An alternative way to execute <code>dest = src</code> .	Assign string data to <code>s3</code> and <code>s4</code> . <code>strcpy(s3, 'howdy');</code> <code>strcpy(s4, "so long");</code>
<code>strcat</code>	<code>dest = strcat(s1, ..., sN)</code>	Concatenates strings <code>s1, ..., sN</code> .	Concatenate strings to form "Stateflow". <code>s1 = "State";</code> <code>s2 = "flow";</code> <code>dest = strcat(s1,s2);</code>
<code>substr</code>	<code>dest = substr(str,i,n)</code>	Returns the substring of length <code>n</code> starting at the <code>i</code> -th character of string <code>str</code> . Use zero-based indexing.	Extract substring "Stateflow" from a longer string. <code>str = "Stateflow rule the waves";</code> <code>dest = substr(str,0,9);</code>
<code>tostring</code>	<code>dest = tostring(X)</code>	Converts numeric, Boolean, or enumerated data to string.	Convert numeric value to string "1.2345". <code>dest = tostring(1.2345);</code> Convert Boolean value to string "true". <code>dest = tostring(1==1);</code> Convert enumerated value to string "RED". <code>dest = tostring(RED);</code>
<code>strcmp</code>	<code>tf = strcmp(s1,s2)</code>	Compares strings <code>s1</code> and <code>s2</code> . Returns <code>0</code> if the two strings are identical. Otherwise returns a nonzero integer. <ul style="list-style-type: none">The sign of the output value depends on the lexicographic ordering of the input strings <code>s1</code> and <code>s2</code>.The magnitude of the output value depends on the compiler that you use. This value can differ in simulation and generated code. Strings are considered identical when they have the same size and content. This operator is consistent with the C library function <code>strcmp</code> or the C++ function <code>string.compare</code> , depending on the compiler that you select	Return a value of <code>0</code> (strings are equal). <code>tf = strcmp("abc", "abc");</code>

Operator	Syntax	Description	Example
		for code generation. The operator behaves differently than the function <code>strcmp</code> in MATLAB.	Return a nonzero value (strings are not equal). <code>tf = strcmp("abc", "abcd");</code>
	<code>s1 == s2</code>	An alternative way to execute <code>strcmp(s1,s2) == 0</code> .	Return a value of true. <code>"abc" == "abc";</code>
	<code>s1 != s2</code>	An alternative way to execute <code>strcmp(s1,s2) != 0</code> .	Return a value of true. <code>"abc" != "abcd";</code>
	<code>tf = strcmp(s1,s2,n)</code>	Returns 0 if the first <code>n</code> characters in <code>s1</code> and <code>s2</code> are identical.	Return a value of 0 (substrings are equal). <code>tf = strcmp("abc", "abcd", 3);</code>
<code>strlen</code>	<code>L = strlen(str)</code>	Returns the number of characters in the string <code>str</code> .	Return a value of 9. <code>L = strlen("Stateflow");</code>
<code>str2double</code>	<code>X = str2double(str)</code>	Converts the text in string <code>str</code> to a double-precision value. <code>str</code> contains text that represents a number. Text that represents a number can contain: <ul style="list-style-type: none"> • Digits • A decimal point • A leading + or - sign • An <code>e</code> preceding a power of 10 scale factor If <code>str2double</code> cannot convert text to a number, then it returns a NaN value.	Return a value of -12.345. <code>X = str2double("-12.345");</code> Return a value of 123400. <code>X = str2double("1.234e5");</code>
<code>str2ascii</code>	<code>A = str2ascii(str,n)</code>	Returns array of type <code>uint8</code> containing ASCII values for the first <code>n</code> characters in <code>str</code> , where <code>n</code> is a positive integer. Use of variables or expressions for <code>n</code> is not supported.	Return <code>uint8</code> array {72, 101, 108, 108, 111}. <code>A = str2ascii("Hello", 5);</code>
<code>ascii2str</code>	<code>dest = ascii2str(A)</code>	Converts ASCII values in array <code>A</code> of type <code>uint8</code> to string.	Return string "Hi!". <code>A[0] = 72;</code> <code>A[1] = 105;</code> <code>A[2] = 33;</code> <code>dest = ascii2str(A);</code>

Where to Use Strings

Use string data at these levels of the Stateflow hierarchy:

- Chart
- Subchart
- State

Use string data as arguments for:

- State actions
- Condition and transition actions
- Graphical functions
- Simulink functions
- Truth table functions that use C as the action language

If you have Simulink Coder installed, you can use string data for simulation and code generation.

See Also

`ascii2str` | `str2ascii` | `str2double` | `strcat` | `strcmp` | `strcpy` | `strlen` | `substr` | `tostring`

More About

- “Log String Data to the Simulation Data Inspector” on page 21-6
- “Send Messages with String Data” on page 21-10
- “Share String Data with Custom C Code” on page 21-13
- “Simulate a Media Player by Using Strings” on page 21-17
- “Simulink Strings” (Simulink)

Log String Data to the Simulation Data Inspector

This example shows how to build a Stateflow chart that, based on numeric input data, concatenates string data into natural language output text. You can view the output text in the Simulation Data Inspector and in the MATLAB workspace. For more information on string data, see “Manage Textual Information by Using Strings” on page 21-2.

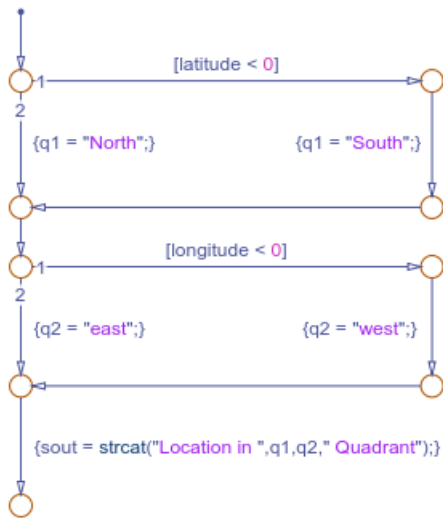

Chart Behavior

During simulation, Sine Wave blocks provide the position of a point moving along a closed path in terms of latitude and longitude coordinates. The chart examines these coordinates and assigns the strings q1 and q2 according to the information in this table.

Latitude	Longitude	q1	q2
positive	positive	"North"	"east"
positive	negative	"North"	"west"
negative	positive	"South"	"east"
negative	negative	"South"	"west"

Then, the statement

```
sout = strcat("Location in ",q1,q2," Quadrant");
```

concatenates these strings into an output string.

Build the Model

Add Junctions and Transitions

- 1 To create a Simulink model with an empty chart that uses the C action language, at the MATLAB command prompt, enter

```
sfnew -c
```

- 2 In the empty chart, place a default transition. A junction appears. Point and drag from the edge of the junction to add other transitions and junctions.
- 3 Double-click each transition. At the text prompt, enter the appropriate condition or action statement.

Define Chart Data

- 1 To resolve the undefined data, in the Symbols pane, click the **Resolve undefined symbols** icon . The Stateflow Editor assigns an appropriate scope to each symbol in the chart.

Symbol	Scope
latitude	Input Data
longitude	Input Data
q1	Local Data
q2	Local Data
sout	Output Data

- 2 To specify q1 as string data, in the **Type** field of the Property Inspector, select `string`. Repeat that specification for q2 and sout.

Alternatively, to create string data with a maximum number of characters, specify each string as `stringtype(n)` using a suitable buffer size n to avoid truncation of its contents. For instance, this table lists suitable buffer sizes for the string data in the chart.

Symbol	Number of Characters	String Data Type
q1	5	<code>stringtype(5)</code>
q2	5	<code>stringtype(5)</code>
sout	30	<code>stringtype(30)</code>

Add Sources and Sinks to the Model

- 1 In the Simulink model, add two Sine Wave blocks and a Display block. Connect the blocks to the chart input and output ports.

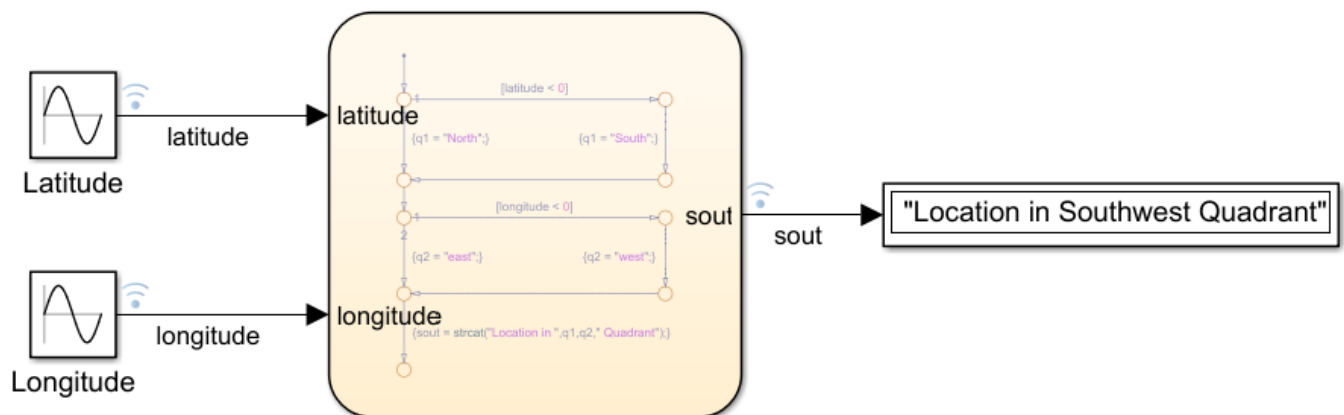

- Set the Sine Wave block parameters as indicated in this table.

Block	Amplitude	Bias	Frequency	Phase
Latitude	50	0	1	0
Longitude	50	0	1	$\pi/2$

- Label the signals in the model as `latitude`, `longitude`, and `sout`. Right-click each signal and select **Log Selected Signals**.

View Simulation Results

- When you simulate the model, the **Simulation Data Inspector** icon  is highlighted to indicate that it has new simulation data. To open the Simulation Data Inspector, click the icon.
- In the Simulation Data Inspector, select the check boxes for the `latitude`, `longitude`, and `sout` signals so that they are displayed on the same set of axes. The `latitude` and `longitude` signals appear as sinusoidal curves. The `sout` signal is shown as a transition plot. The value of the string is displayed inside a band and criss-crossed lines mark the changes in value.

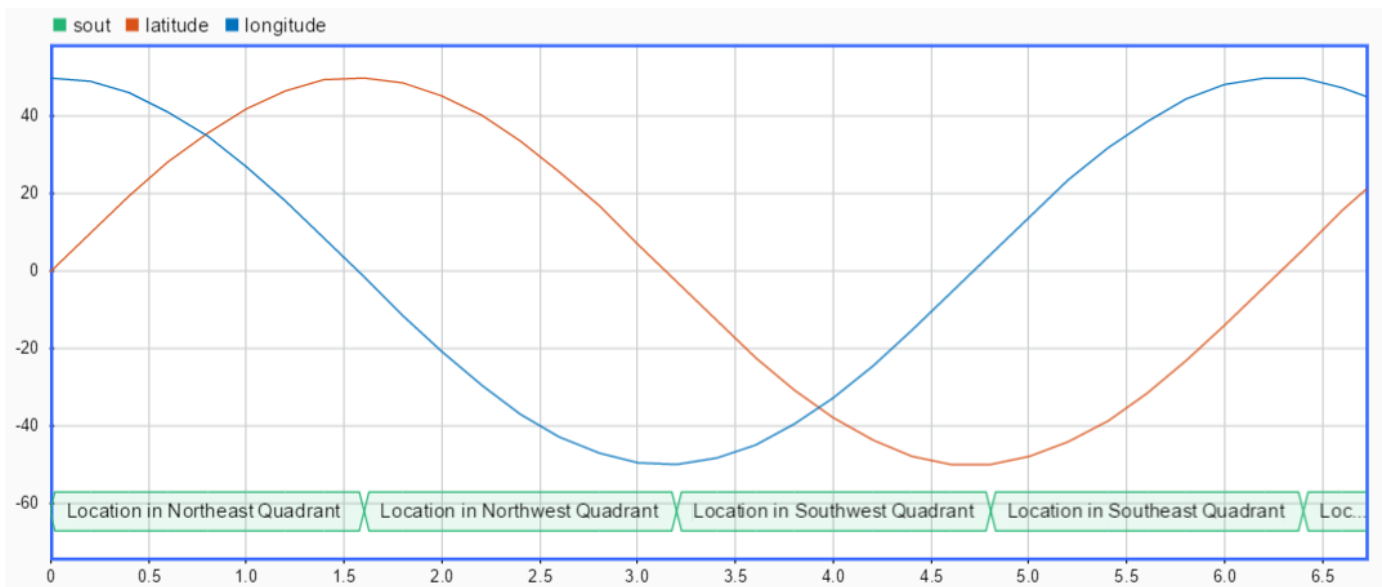

- To access the logged data in the MATLAB workspace, call the signal logging object `logout`. Stateflow exports the string data `sout` as a MATLAB string scalar. For example, at the command prompt, enter:

```
logout = out.logout;
Tbl = table(logout.get('latitude').Values.Data, ...
    logout.get('longitude').Values.Data, ...
    logout.get('sout').Values.Data);
Tbl.Properties.VariableNames = ...
    {'Latitude', 'Longitude', 'QuadrantInfo'};
Tbl([4:8:30],:)
```

ans =

```
4x3 table
```

Latitude	Longitude	QuadrantInfo
28.232	41.267	"Location in Northeast Quadrant"
40.425	-29.425	"Location in Northwest Quadrant"
-30.593	-39.548	"Location in Southwest Quadrant"
-38.638	31.735	"Location in Southeast Quadrant"

See Also

`get` | `strcat` | `table`

More About

- “Manage Textual Information by Using Strings” on page 21-2
- “Log Simulation Output for States and Data” on page 33-45
- “View Data with the Simulation Data Inspector” (Simulink)
- “Export Signal Data Using Signal Logging” (Simulink)

Send Messages with String Data

This example shows how to configure a pair of Stateflow charts that communicate by sending messages that carry string data. For more information, see “Communicate with Stateflow Charts by Sending Messages” on page 12-2.

This model contains two charts that use C as the action language. During simulation, the Emitter chart reads an input string `key` from the String Constant block and sends a message to the Receiver chart. The message data consists of the input string `key`. The Receiver chart compares the string with a constant keyword and returns an output string that grants or denies access.

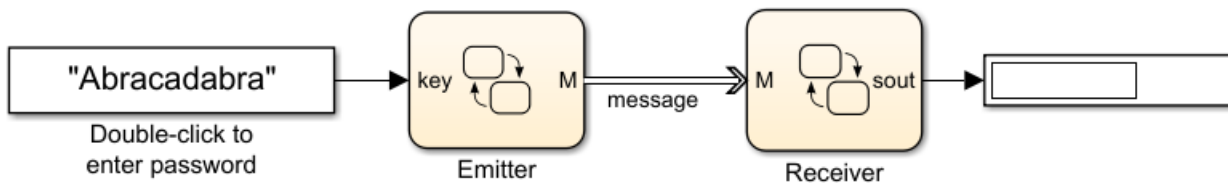

Emitter Chart

The Emitter chart consists of a single state A. When the state becomes active, it sets the data for the message M to the input value `key` and sends the message to the Receiver chart.

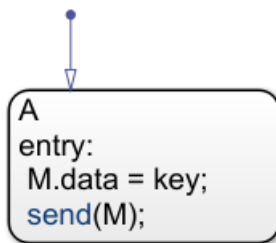

This table lists the scope and type for the symbols in the chart.

Symbol	Scope	Type
key	Input Data	Inherit: Same as Simulink
M	Output Message	string

Receiver Chart

The chart consists of two states joined by a transition. The input message M guards the transition. If there is a message present and its data value equals the constant string `lock`, then the state activity transitions from Off to On. The chart outputs the string value 'Access Granted'. If there is no message present, or if the data value does not equal `lock`, the chart does not take the transition and the output value is 'Access Denied'.



This table lists the scope and type for the symbols in the chart.

Symbol	Scope	Type
M	Input Message	Inherit: Same as Simulink
lock	Constant Data	string
sout	Output Data	string

The constant string `lock` contains a secret password, initially set to 'Open Sesame'. You can change the value of `lock` in the **Initial value** field of the Property Inspector.

View Simulation Results

During simulation, the model responds to the password that you enter in the String Constant block:

- If you enter an incorrect password, such as "Abracadabra", then the model displays the output string "Access Denied".

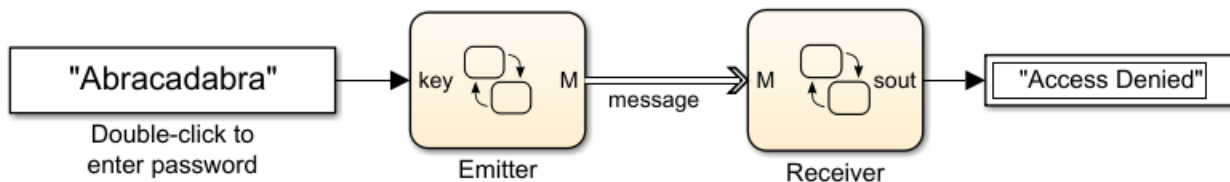

- If you enter the correct password, in this case, "Open Sesame", then the model displays the output string "Access Granted".

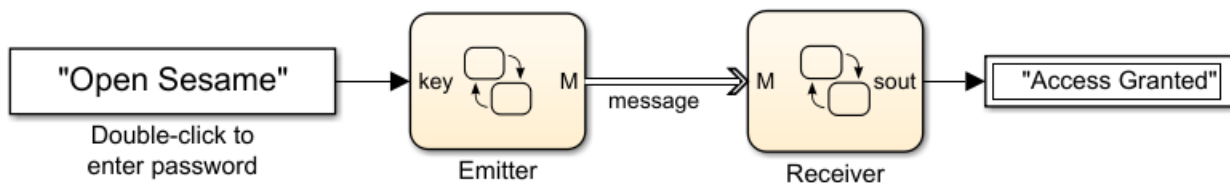

See Also

send

More About

- "Manage Textual Information by Using Strings" on page 21-2

- “Log String Data to the Simulation Data Inspector” on page 21-6
- “Share String Data with Custom C Code” on page 21-13
- “Simulate a Media Player by Using Strings” on page 21-17
- “Communicate with Stateflow Charts by Sending Messages” on page 12-2
- “View Differences Between Stateflow Messages, Events, and Data” on page 12-23

Share String Data with Custom C Code

This example shows how to share string data between a Stateflow® chart and custom C code. You can export string data from a Stateflow chart to a C function by using the `str2ascii` operator. You can import the output of your C code as string data in a Stateflow chart by using the `ascii2str` operator. By sharing data with custom code, you can augment the capabilities of Stateflow and leverage the software to take advantage of your preexisting code. For more information, see “Reuse Custom Code in Stateflow Charts” on page 31-19.

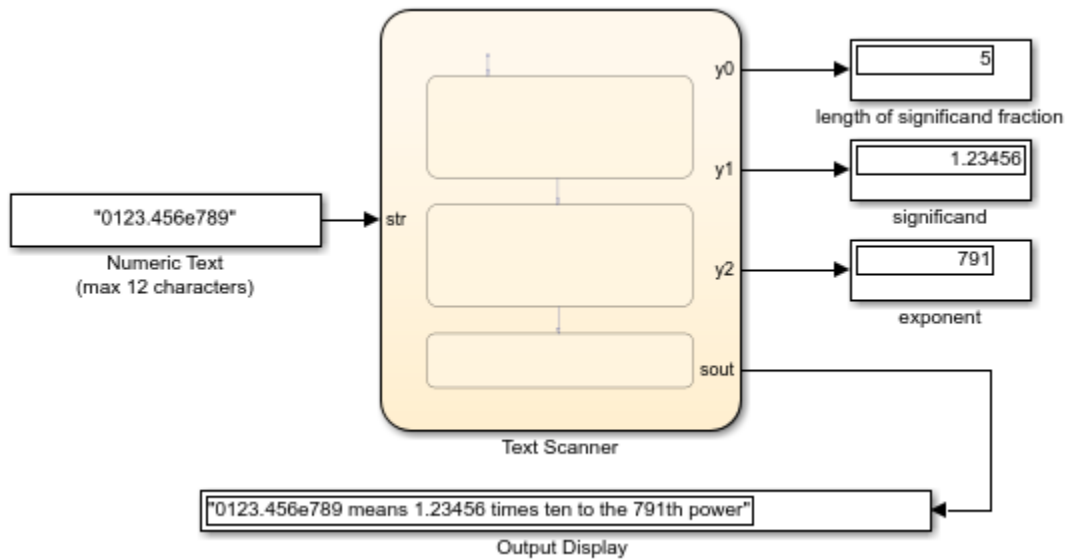

This model contains a Stateflow chart that calls two functions from custom C code. During simulation, the chart takes as its input a string that contains text representing a floating-point number in exponential form. The chart consists of three states that:

- Search the input string for leading zeroes, a decimal point, and an e.
- Parse the string into double-precision numbers representing the significand and exponent parts of the input.
- Merge the numeric information into an output string expressing the input in scientific notation.

For example, if the input string is "0123.456e789", then the chart outputs the string "0123.456e789 means 1.23456 times ten to the 791th power".

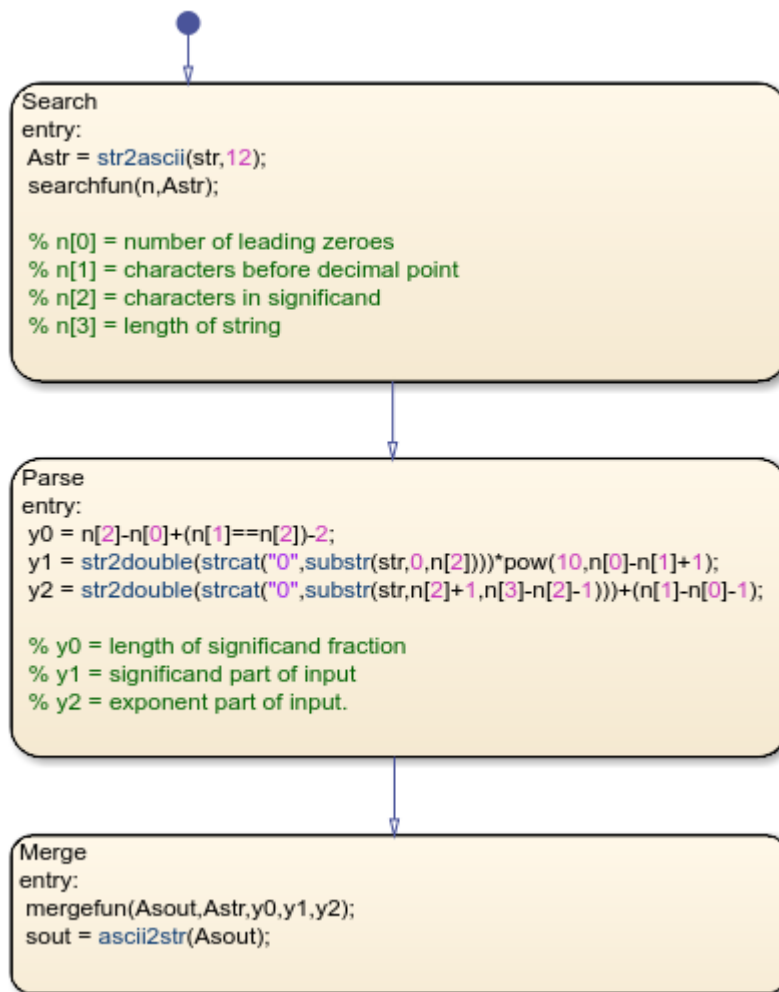

Export String Data from Stateflow to C

You can use the `str2ascii` operator to convert string data into an array that you can export from a Stateflow chart to a custom C code function.

- 1 In the custom code function, declare the input variable as having type `char*`.
- 2 In the Stateflow chart, convert the string to an array of type `uint8` by calling the operator `str2ascii`.
- 3 Call the custom code function by passing the `uint8` array as an input.

For example, in the previous chart, the `Search` state converts the input string `str` to the `uint8` array `Asrt`. The `Search` state passes this array as an input to the custom code function:

```

extern void searchfun(int* nout, char* strin)
{
    nout[0] = strspn(strin,"0");
    nout[1] = strcspn(strin, ".e");
    nout[2] = strcspn(strin, "e");
    nout[3] = strlen(strin);
}
  
```

The `Search` state calls this function with the command `searchfun(n, Astring)`. The function populates the integer array `n` with these values:

- `n[0]` contains the number of leading zeroes in the input string `string`.
- `n[1]` contains the number of characters before the first instance of a decimal point or `e`. This result provides the number of characters before the decimal point in `string`.
- `n[2]` contains the number of characters before the first instance of `e`. This result provides the number of characters in the significand in `string`.
- `n[3]` contains the length of the input string `string`.

The `Parse` state uses these results to extract the values of the significand and exponent parts of the input.

Import String Data from C to Stateflow

You can import string data to a Stateflow chart by passing a pointer to an array of type `uint8` as an input to a custom C function.

- 1 In the custom code function, declare the input variable containing the pointer as having type `char*`.
- 2 Save the output string data from the custom code function at the location indicated by the pointer.
- 3 In the Stateflow chart, convert the `uint8` array to a string by calling the operator `ascii2str`.

For example, in the previous chart, the `Merge` state consolidates the numeric information obtained by the `Parse` state into an output string by calling the custom code function `mergefun`:

```
extern void mergefun(char* strout, char* strin, int in0, double in1, double in2)
{
    sprintf(strout, "%s means %1.*f times ten to the %dth power", strin, in0, in1, (int) in2);
}
```

The `Merge` state calls the `mergefun` function with the command `mergefun(Astring, Astring, y0, y1, y2)`:

- `Astring` is an array of type `uint8` pointing to the output of the custom function.
- `Astring` is an array of type `uint8` corresponding to the input string to the chart.
- `y0` is an integer containing the number of digits to the right of the decimal point in the significand.
- `y1` and `y2` are double-precision numbers representing the significand and exponent parts of the input.

The function `mergefun` calls the C library function `sprintf`, merging the contents of `Astring`, `y1`, and `y2` and storing the result in the memory location indicated by `Astring`. The chart uses the operator `ascii2str` to convert this output to the string `sout`. In this way, the model imports the string constructed by the custom code function back into Stateflow.

See Also

`ascii2str` | `str2ascii` | `str2double` | `strcat` | `substr`

More About

- “Manage Textual Information by Using Strings” on page 21-2
- “Log String Data to the Simulation Data Inspector” on page 21-6
- “Send Messages with String Data” on page 21-10
- “Simulate a Media Player by Using Strings” on page 21-17
- “Reuse Custom Code in Stateflow Charts” on page 31-19

Simulate a Media Player by Using Strings

This example models a media player by using string data in two Stateflow® C action language charts. The model plays a clip of music and other pre-recorded sounds. During simulation, the charts use strings to control the behavior of the media player and provide natural language output messages.

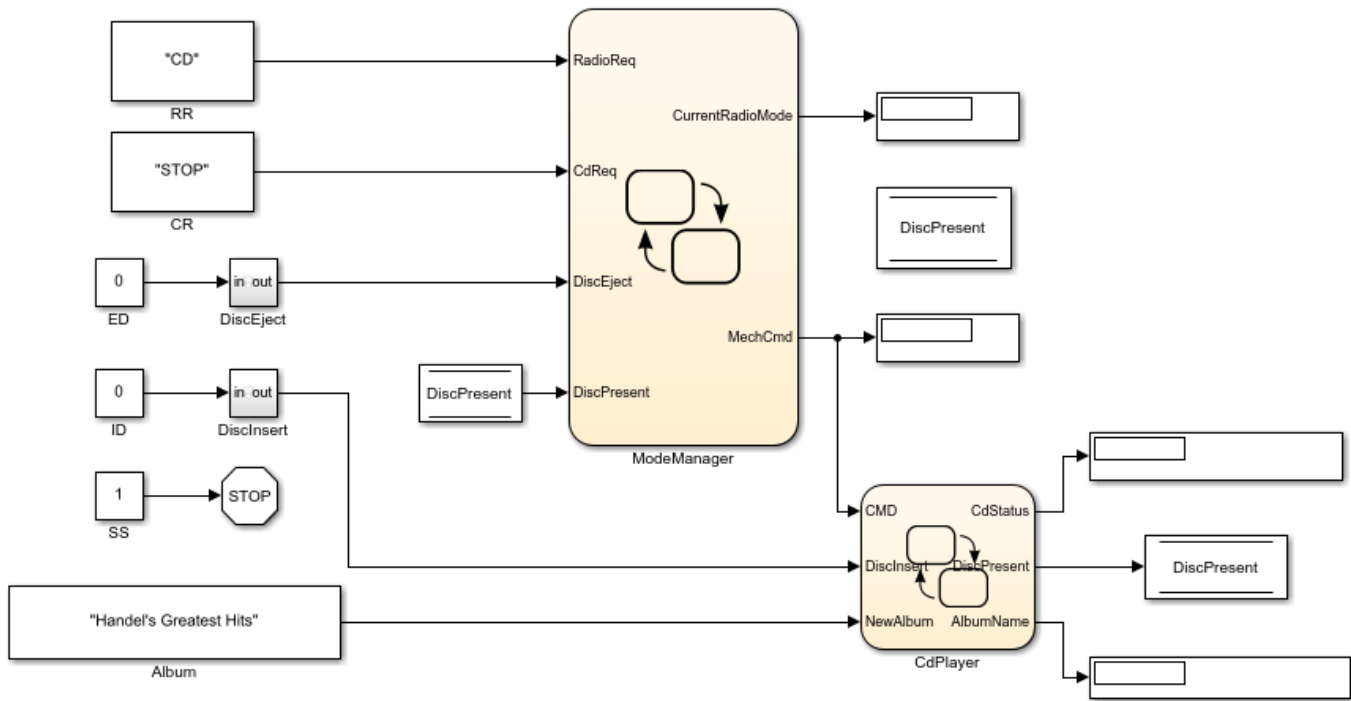

Run the Media Player Model

1. Simulate the model. The Media Player Helper appears.

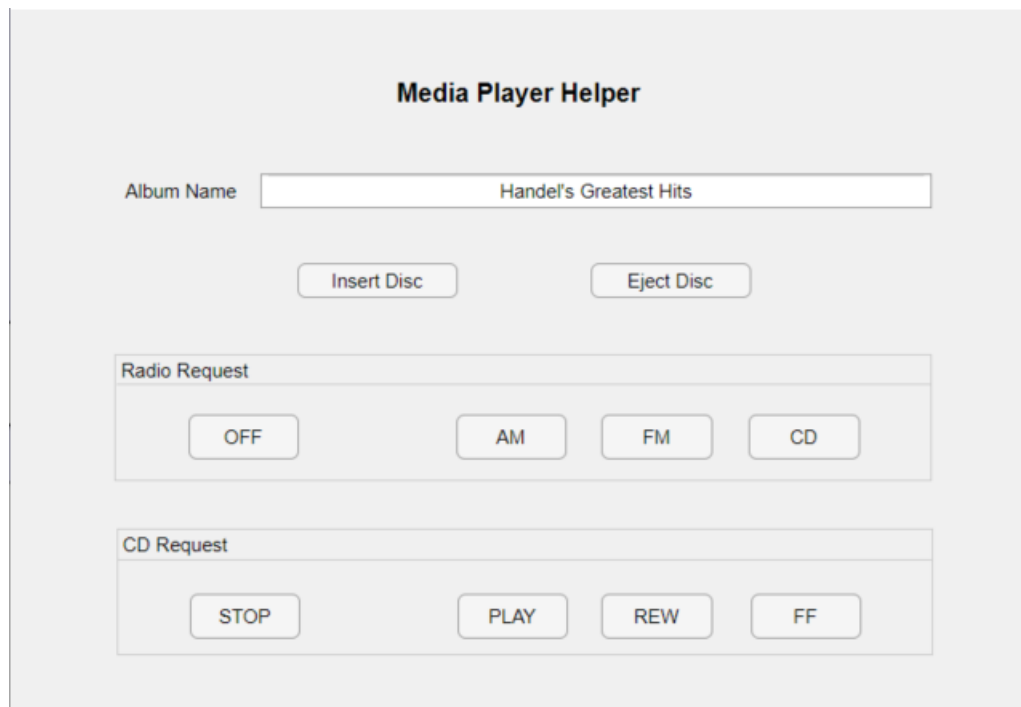

In the model, the Display blocks show the default settings of the media player:

- CurrentRadioMode: "Standby (OFF) "
- MechCmd: "STOP"
- CdStatus: "EMPTY"
- AlbumName: "None"

2. In the **Radio Request** section, click **CD**.

- The String Constant block RR changes from "OFF" to "CD".
- The Display block for CurrentRadioMode changes from "Standby (OFF)" to "CD Player".

3. Click **Insert Disc**.

- The Display block for AlbumName changes from "None" to "Handel's Greatest Hits".
- The Display block for CdStatus changes from "EMPTY" to "Reading: Handel's Greatest Hits" to "Stopped".

4. In the **CD Request** section, click **PLAY**.

- The String Constant block CR and the Display block for MechCmd change from "STOP" to "PLAY".
- The Display block for CdStatus changes from "Stopped" to "Playing: Handel's Greatest Hits".
- Music begins to play.

5. In the **CD Request** section, click **FF**.

- Music stops and chirping sounds begin.

- The String Constant block CR and the Display block for MechCmd change from "PLAY" to "FF".
- The Display block for CdStatus changes from "Playing: Handel 's Greatest Hits" to "Forward >> Handel 's Greatest Hits". The album name in this message scrolls forward across the display.

To see other changes in the Display blocks, use the Media Player Helper to select other operating modes or to enter a different album name.

ModeManager Chart

This chart activates the appropriate subcomponent of the media player (AM radio, FM radio, or CD player) depending on the inputs received from the Media Player Helper.

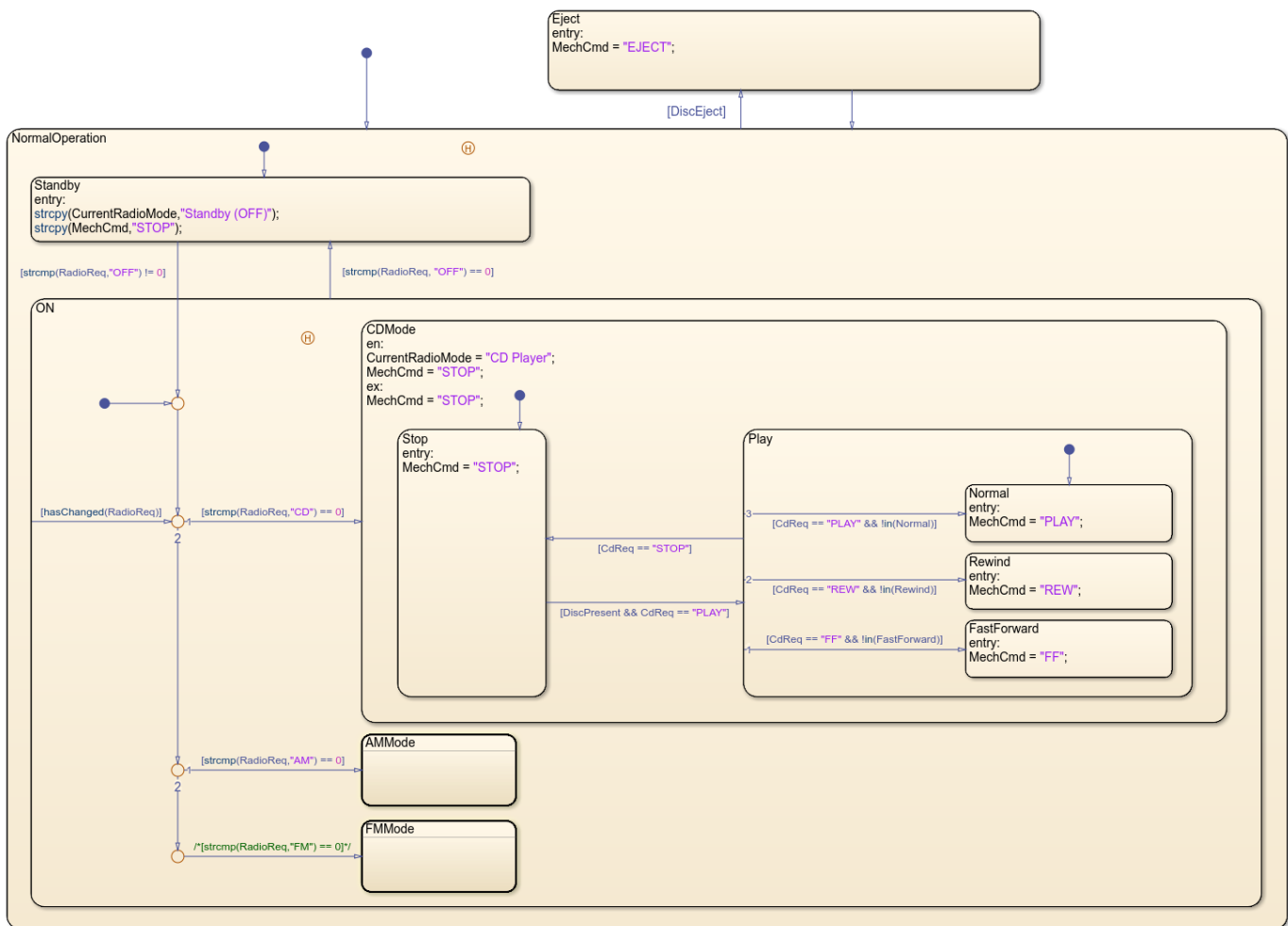

Key Features

- String data RadioReq, CdReq, and MechCmd control chart behavior.
- String data CurrentRadioMode provides natural language output.
- Operators strcpy and = assign values to string data.
- Operators strcmp and == compare values of string data.

- Operator `hasChanged` detects changes in the value of `RadioReq`.

Chart Behavior

At the start of simulation, the `NormalOperation` state becomes active. If the Boolean data `DiscEject` is 1 (or `true`), a transition to the `Eject` state occurs, followed by a transition back to the `NormalOperation` state.

When `NormalOperation` is active, the previously active substate (`Standby` or `ON`) as recorded by the history junction becomes active. Subsequent transitions between the `Standby` and `ON` substates depend on the value of the expression `strcmp(RadioReq, "OFF")`:

- If `strcmp` returns a value of zero, then `RadioReq` is "OFF" and the `Standby` substate is activated.
- If `strcmp` returns a nonzero value, then `RadioReq` is not "OFF" and the `ON` substate is activated.

In the `ON` substate, three substates represent the operating modes of the media player: CD player, AM radio, and FM radio. Each substate corresponds to a different value of string data `RadioReq`. The inner transition inside the `ON` state continually scans for changes in the value of `RadioReq`.

- If the value of `RadioReq` is "CD", then the substate `CDMode` becomes active, setting the media player to CD player mode. The `ModeManager` chart outputs "PLAY", "REW", "FF", and "STOP" commands to the `CdPlayer` chart through the string data `MechCmd`.
- If the value of `RadioReq` is "AM", then the substate `AMMode` becomes active, setting the media player to AM radio mode. The `ModeManager` chart outputs a "STOP" command to the `CdPlayer` chart through the string data `MechCmd`.
- If the value of `RadioReq` is "FM", then the substate `FMMode` becomes active, setting the media player to FM radio mode. The `ModeManager` chart outputs a "STOP" command to the `CdPlayer` chart through the string data `MechCmd`.

CdPlayer Chart

This chart activates the appropriate operating mode for the CD player depending on the input received from the `ModeManager` chart.

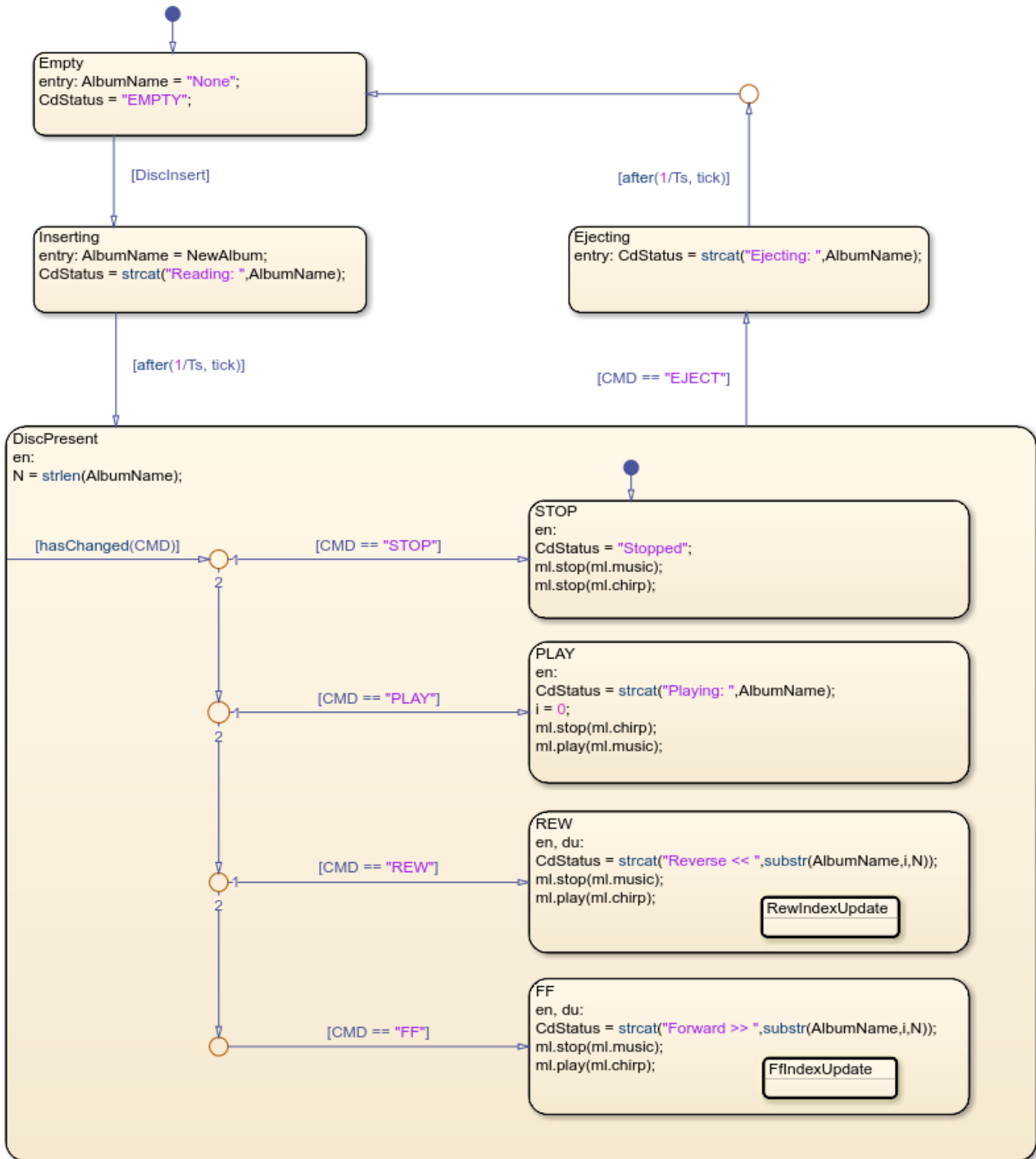

Key Features

- String data Cmd controls chart behavior.

- String data `NewAlbum`, `AlbumName`, and `CdStatus` provide natural language output.
- Operators `=` and `==` assign and compare values of string data.
- Operators `strcat`, `strlen`, and `substr` produce text in output string `CdStatus`.
- Temporal logic operator `after` controls the timing of transitions during disc insertion and ejection.
- Namespace operator `ml` accesses MATLAB® `play` and `stop` functions to manage music and sounds.

Chart Behavior

At the start of simulation, the `Empty` state is activated.

If the Boolean data `DiscInsert` is `1` (or `true`), a transition to the `Inserting` state occurs. After a short time delay, a transition to the `DiscPresent` state occurs.

The `DiscPresent` state remains active until the data `CMD` becomes `"EJECT"`. At that point, a transition to the `Ejecting` state occurs. After a short time delay, a transition to the `Empty` state occurs.

Whenever a state transition occurs, the entry action in the new state changes the value of `CdStatus` to reflect the status of the CD player. In the `FF` or `REW` substates, the during actions continually change the value of `CdStatus` to produce a scrolling motion effect.

- When the active state is `Empty`, the value of `CdStatus` is `"EMPTY"`.
- When the active state is `Inserting`, the value of `CdStatus` is `"Reading: AlbumName"`.
- When the active state is `Ejecting`, the value of `CdStatus` is `"Ejecting: AlbumName"`.
- When the active state is `DiscPresent.STOP`, the value of `CdStatus` is `"Stopped"`.
- When the active state is `DiscPresent.PLAY`, the value of `CdStatus` is `"Playing: AlbumName"`.
- When the active state is `DiscPresent.REW`, the value of `CdStatus` is `"Reverse << AlbumName"`, where `AlbumName` scrolls backward across the display.
- When the active state is `DiscPresent.FF`, the value of `CdStatus` is `"Forward >> AlbumName"`, where `AlbumName` scrolls forward across the display.

See Also

`after` | `strcat` | `strcmp` | `strcpy` | `strlen` | `substr`

More About

- “Manage Textual Information by Using Strings” on page 21-2
- “Detect Changes in Data Values” on page 13-56
- “Control Chart Execution by Using Temporal Logic” on page 13-40
- “Access MATLAB Functions and Workspace Data in C Charts” on page 13-28
- “Record and Play Audio” (MATLAB)
- “Simulink Strings” (Simulink)

Continuous-Time Systems in Stateflow Charts

- “Continuous-Time Modeling in Stateflow” on page 22-2
- “Store Continuous State Information in Local Variables” on page 22-7
- “Model a Bouncing Ball in Continuous Time” on page 22-9
- “Model a DC Motor in Stateflow” on page 22-13
- “Model the Dynamics of Moving Billiard Balls” on page 22-15
- “Model Newton's Cradle” on page 22-20
- “Modeling Newton's Cradle with Virtual Reality” on page 22-24

Continuous-Time Modeling in Stateflow

Hybrid systems use modal logic to transition from one mode to another in response to physical events and conditions. In these systems, continuous-time dynamics govern each mode. A simple example of this type of hybrid system is a bouncing ball. The ball moves continuously through the air until it hits the ground, at which point a mode change or discontinuity occurs. As a result, the ball suddenly changes direction and velocity. For more information, see “Model a Bouncing Ball in Continuous Time” on page 22-9.

Simulate hybrid systems that respond to continuous and discrete mode changes by configuring Stateflow charts for continuous-time modeling. In a Stateflow chart, you can represent modal logic succinctly and intuitively as a series of states, transitions, or flow charts. You can also represent state information as continuous local variables with automatic access to time derivatives.

Continuous-time simulation is supported only in Stateflow charts in Simulink models. If your continuous system does not contain modal logic, consider using a Simulink model. For more information, see “Model a Continuous System” (Simulink).

Configure a Stateflow Chart for Continuous-Time Simulation

Continuous updating is a Stateflow chart property.

- 1 Right-click inside a chart and select **Properties** from the context menu.
- 2 In the Chart Properties dialog box, set the **Update method** field to **Continuous**. When you select this option:
 - The **Enable zero-crossing detection** check box is selected.
 - The **Enable super step semantics** check box is unavailable.

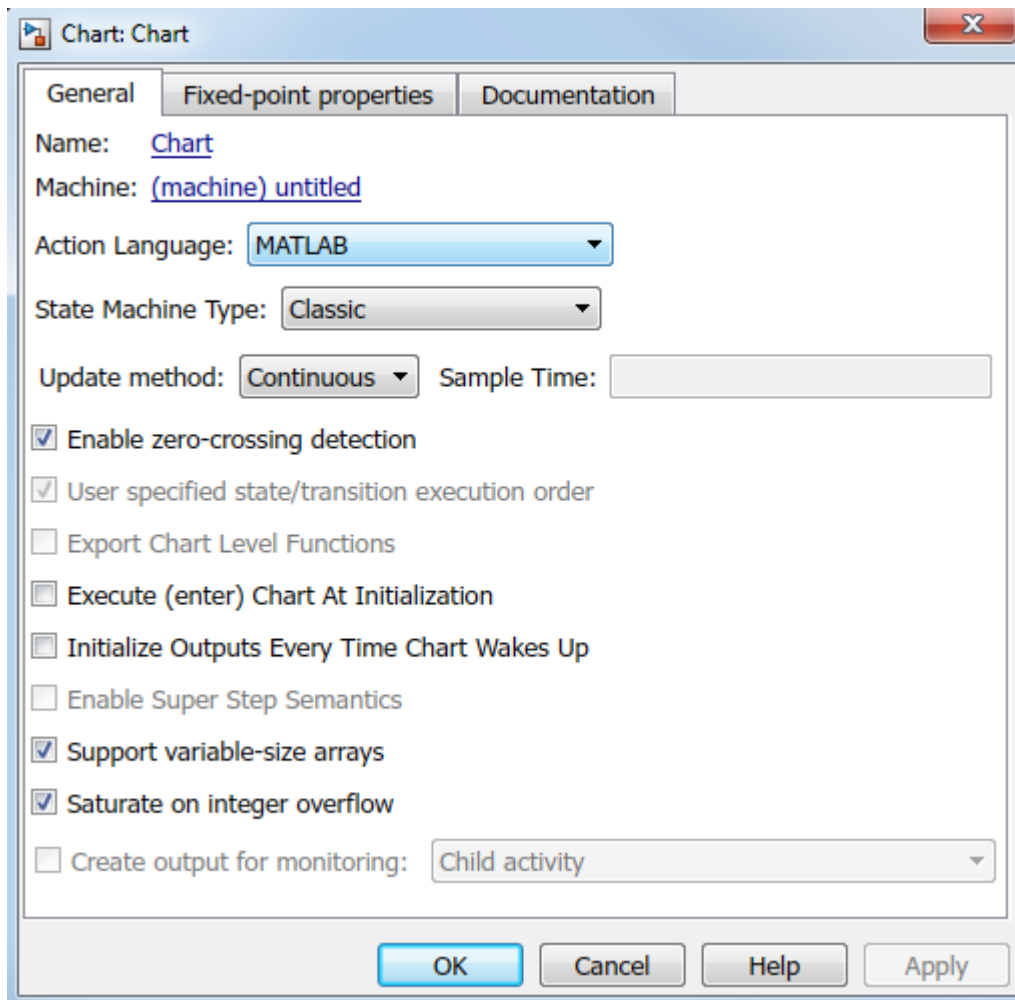

- 3 (Optional) By default, zero-crossing detection is enabled. To disable this option, clear the **Enable zero-crossing detection** check box. For more information, see “Disable Zero-Crossing Detection” on page 22-4.
- 4 Click **OK**.

Note You cannot use Moore charts for continuous-time modeling.

Interaction with Simulink Solver

Maintain Mode in Minor Time Steps

During continuous-time simulation, a Stateflow chart updates its mode only in major time steps. In a minor time step, the chart computes outputs based on the state of the chart during the last major time step. For more information, see “Continuous Sample Time” (Simulink).

Compute Continuous State at Each Time Step

When you define local continuous variables, the Stateflow chart provides programmatic access to their derivatives. The Simulink solver computes the continuous state of the chart at the current time

step based on the values of these variables and their derivatives at the previous time step. For more information, see “Continuous Versus Discrete Solvers” (Simulink).

Register Zero Crossings on State Transitions

To determine when a state transition occurs, a Stateflow chart registers a zero-crossing function with the Simulink solver. When Simulink detects a change of mode, the solver searches forward from the previous major time step to detect when the state transition occurred. For more information, see “Zero-Crossing Detection” (Simulink).

Disable Zero-Crossing Detection

Zero-crossing detection on state transitions can present a tradeoff between accuracy and performance. When detecting zero crossings, a Simulink model accurately simulates mode changes without unduly reducing step size. For systems that exhibit *chattering*, or frequent fluctuations between two modes of continuous operation, zero-crossing detection can potentially impact simulation time. Chattering requires a Simulink model to check for zero crossings in rapid succession, which can slow simulation. In these situations, you can:

- Disable zero-crossing detection.
- Choose a different zero-crossing detection algorithm for your chart.
- Modify parameters that control the frequency of zero crossings in your Simulink model.

You can choose from different zero-crossing detection algorithms on the **Solver** pane in the Model Configuration Parameters dialog box. For more information, see “Zero-Crossing Detection” (Simulink).

Guidelines for Continuous-Time Simulation

To maintain the integrity and smoothness of the results of a continuous-time simulation, constrain your charts to a restricted subset of Stateflow chart semantics. By restricting the semantics, the inputs do not depend on unpredictable factors such as:

- The number of minor intervals that the Simulink solver uses in each major time step.
- The number of iterations required to stabilize the integration and zero-crossings algorithms.

By minimizing these side effects, a Stateflow chart can maintain its state at minor time steps and update its state only during major time steps. Therefore, a Stateflow chart can compute outputs based on a constant state for continuous time.

Continuous-Time Charts Must Have at Least One State

During continuous-time simulation, a chart updates its outputs at minor time steps corresponding to the during actions of the active state. A chart with no states produces no output. To mimic the behavior of a stateless chart in continuous time, create a single state that calls a graphical function in its during action.

Update Local Data in entry, exit, and Transition Actions

To maintain precision in continuous-time simulation, update discrete and continuous local data only during major time steps corresponding to state transitions. During state transitions, only these types of actions occur:

- State `exit` actions, which occur before leaving the state at the beginning of the transition.
- State `entry` actions, which occur after entering the new state at the end of the transition.
- Transition actions, which occur during the transition.
- Condition actions on a transition, but only if the transition directly reaches a state. For example, this chart executes the action `n++` even when conditions `c2` and `c3` are false. Because there is no state transition, the condition action updates `n` in a minor time step and results in an error.

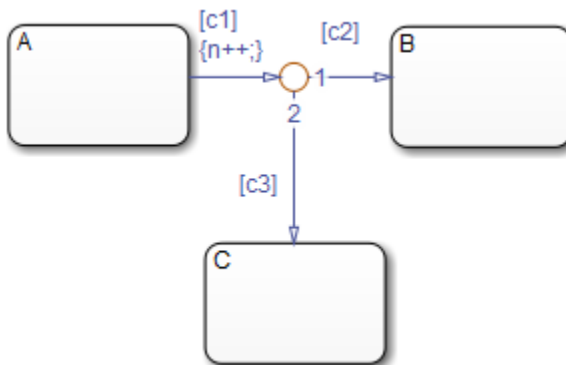

Do not write to local continuous data in state during actions because these actions occur in minor time steps.

Compute Derivatives in State during Actions

In minor time steps, a continuous-time chart executes only state `during` actions. Because Simulink models read continuous-time derivatives during minor time steps, compute derivatives in `during` actions to provide the most current calculation.

Do Not Read Outputs or Derivatives in State during Actions or in Transition Conditions

In minor time steps, it is possible that outputs and derivatives do not reflect their most current values. To provide smooth outputs, compute values from local discrete data, local continuous data, and chart inputs.

Do Not Call Simulink Functions in State during Actions or in Transition Conditions

You cannot call Simulink functions during minor time steps. Instead, call Simulink functions only in actions that occur during major time steps: state `entry` or `exit` actions and transition actions. Calling Simulink functions in state `during` actions or in transition conditions results in an error during simulation. For more information, see “Reuse Simulink Components in Stateflow Charts” on page 30-2.

Use Discrete Variables to Govern Conditions in during Actions

To prevent mode changes between major time steps, conditions that affect control flow in `during` actions depend on discrete variables. Discrete variables do not change value between major time steps.

Do Not Use Input Events

The presence of input events makes a chart behave like a triggered subsystem and unable to simulate in continuous time. For example, this model generates an error if the chart uses a continuous update method.

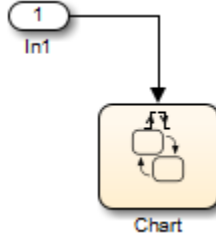

To mimic the behavior of an input event, pass the input signal through a Hit Crossing block as an input to the continuous-time chart.

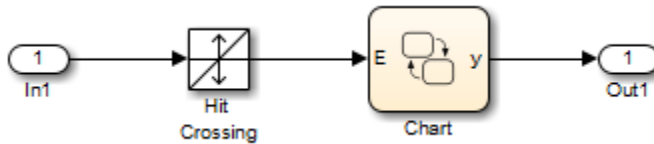

Do Not Use Inner Transitions

When a mode change occurs during continuous-time simulation, the entry action of the destination state indicates to the Simulink model that a state transition occurred. With an inner transition, the chart never executes the entry action. For more information, see “Inner Transitions” on page 3-25.

Limit Use of Temporal Logic

Do not use event-based temporal logic because in continuous-time simulation, there is no concept of a tick. Use only absolute-time temporal logic for continuous-time simulation. For more information, see “Control Chart Execution by Using Temporal Logic” on page 13-40.

Do Not Use Change Detection Operators

To implement change detection, Stateflow buffers variables in a way that affects the behavior of charts between a minor time step and the next major time step.

Do Not Modify Operating Point Values

Modifying the operating point of a continuous-time chart is not supported. If you load the operating point for a continuous-time chart, you cannot modify the activity of states or any values of local or output chart data. For more information, see “Rules for Using the Operating Point of a Chart” on page 17-30.

See Also

More About

- “Model a Bouncing Ball in Continuous Time” on page 22-9
- “Store Continuous State Information in Local Variables” on page 22-7
- “Compare Solvers” (Simulink)
- “Zero-Crossing Detection” (Simulink)

Store Continuous State Information in Local Variables

To compute a continuous state, you must determine its time derivative. You can represent this information by using local variables that are updated in continuous time. Continuous-time simulation is supported only in Stateflow charts in Simulink models. For more information, see “Continuous-Time Modeling in Stateflow” on page 22-2.

Define Continuous-Time Variables

- 1 Configure the chart to update in continuous time, as described in “Configure a Stateflow Chart for Continuous-Time Simulation” on page 22-2.
- 2 Add a data object to your chart, as described in “Add Stateflow Data” on page 9-2.
- 3 Set the **Scope** property for the data object to `Local`.
- 4 Set the **Update Method** property for the data object to `Continuous`.

In a Stateflow chart, continuous-time variables always have type `double`.

Compute Implicit Time Derivatives

For each continuous-time variable, Stateflow implicitly creates a variable to represent its time derivative. A chart denotes time derivative variables as *variable_name_dot*. For example, `data_dot` represents the time derivative of a continuous variable `data`. You can write to the time derivative variable in the `during` action of a state. The time derivative variable does not appear in the Symbols pane or in the Model Explorer.

Note Do not explicitly define variables with the suffix `_dot` in a chart configured for continuous-time simulation.

Expose Continuous State to a Simulink Model

In a Stateflow chart, you represent the continuous state by using local variables rather than inputs or outputs. To expose the continuous state to a Simulink model, you must explicitly assign the local variables to Stateflow outputs in the `during` action of a state.

Guidelines for Continuous-Time Variables

- Scope for continuous-time variables can be `Local` or `Output`.
- Define continuous-time variables at the chart level or below in the Stateflow hierarchy.
- Expose the continuous state of a chart by assigning the local continuous-time variable to a Stateflow output.

See Also

More About

- “Continuous-Time Modeling in Stateflow” on page 22-2

- “Model a Bouncing Ball in Continuous Time” on page 22-9

Model a Bouncing Ball in Continuous Time

This example shows how to configure a Stateflow® chart that simulates a bouncing ball in continuous time. The ball moves continuously through the air until it hits the ground, at which point a discontinuity occurs. As a result, the ball suddenly changes direction and velocity. For more information, see “Continuous-Time Modeling in Stateflow” on page 22-2.

The model `sf_bounce` contains a chart that updates in continuous-time. Local variables describe the dynamics of a free-falling ball in terms of position and velocity. During simulation, the model uses zero-crossing detection to determine when the ball hits the ground.

Dynamics of a Bouncing Ball

You can specify how a ball falls freely under the force of gravity in terms of position p and velocity v with this system of first-order differential equations.

$$\dot{p} = v$$

$$\dot{v} = -9.81$$

When $p \leq 0$, the ball hits the ground and bounces. You can model the bounce by updating the position and velocity of the ball:

- Reset the position to $p = 0$.
- Reset the velocity to the negative of its value just before the ball hit the ground.
- To account for energy loss, multiply the new velocity by a coefficient of distribution (-0.8).

Configure Chart for Continuous-Time Simulation

In the model, the BouncingBall chart implements modal logic to simulate the continuous dynamics of free fall and the discrete changes associated with bouncing. In the Chart properties dialog box, these settings enable the BouncingBall chart to simulate in continuous time:

- **Update method** is **Continuous** so the chart employs continuous-time simulation to model the dynamics of the bouncing ball.
- **Enable zero-crossing detection** is selected so the Simulink® solver can determine exactly when the ball hits the ground. Otherwise, the Simulink model cannot simulate the physics accurately and the ball appears to descend below ground.

Modeling a Bouncing Ball

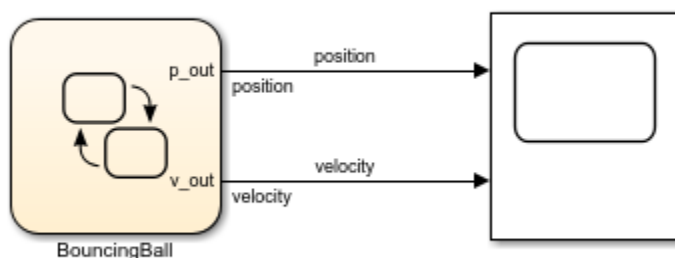

Copyright 2007-2020 The MathWorks, Inc.

Define Continuous-Time Variables

The BouncingBall chart has two continuous-time variables: p for position and v for velocity. For each one of these variables:

- **Scope** is Local.
- **Type** is double.
- **Update Method** is Continuous.

To expose the continuous state of the chart to the Simulink model, the BouncingBall chart has two output variables: p_out and v_out . For each one of these variables:

- **Scope** is Output.
- **Type** is double.
- **Update Method** is Discrete.

The chart defines the time derivative of continuous-time variables implicitly:

- p_dot is the derivative of position p .
- v_dot as the derivative of velocity v .

In the Model Explorer, you can view the continuous-time local variables and the corresponding outputs in the chart. Implicit derivative variables do not appear in the Model Explorer or in the Symbols pane.

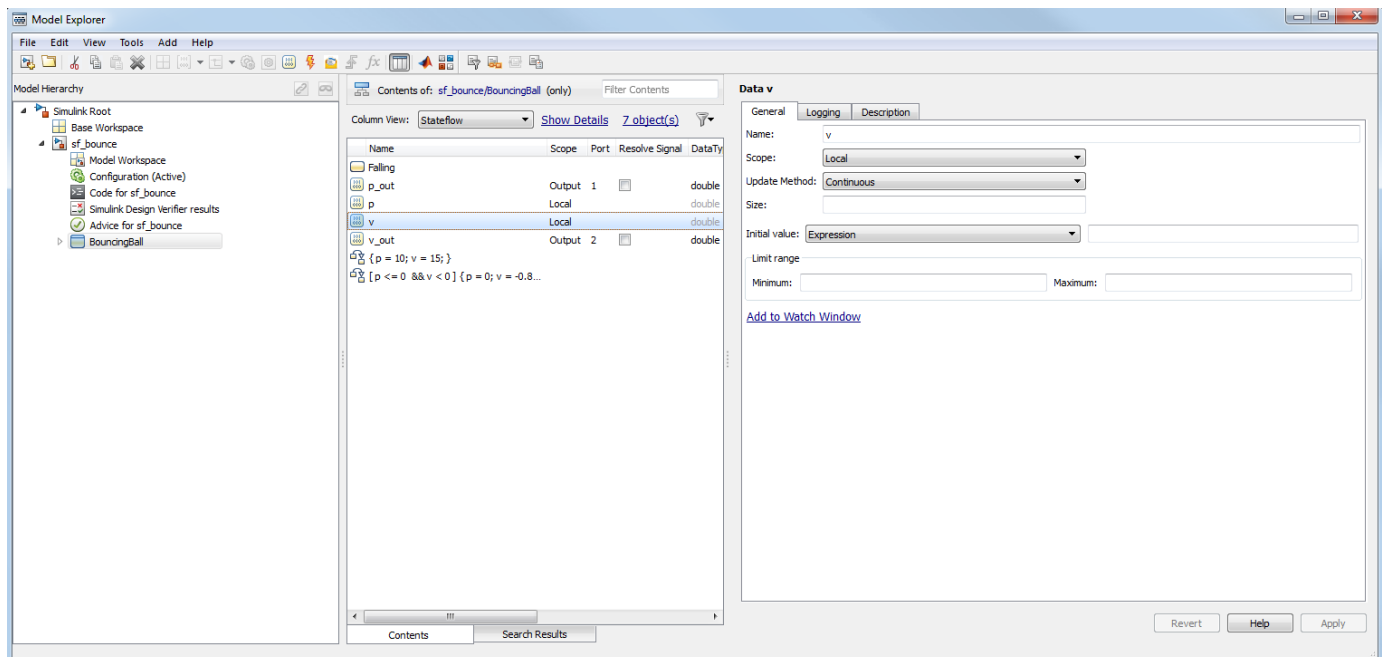

Model Continuous Dynamics of Free Fall

The BouncingBall chart consists of a single state **Falling** that numerically solves the differential equations for free fall. The default transition into the state sets the initial position to 10 m and the initial velocity to 15 m/s. The during actions in the state:

- Define the derivatives of position and velocity.
- Assign the values of the position and velocity of the ball to the output variables `p_out` and `v_out`.

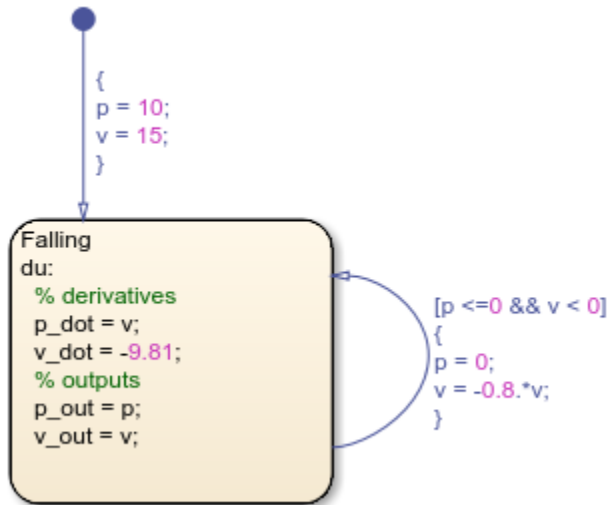

Model Discrete Effects of the Bounce

The `Falling` state has a self-loop transition that models the discontinuity of the bounce as an instantaneous mode change when the ball suddenly reverses direction. The condition on the transition determines when the ball hits the ground by checking its position $p \leq 0$ and velocity $v < 0$. If the condition is valid, the condition action resets the position and velocity when the ball hits the ground.

Why Not Check for $p == 0$?

The ball hits the ground when position p is exactly zero. By relaxing the condition, you increase the tolerance within which the Simulink solver can detect when the position changes sign.

Why Check for $v < 0$?

The second part of the condition helps maintain the efficiency of the Simulink solver by minimizing the frequency of zero crossings. Without the second check, the condition remains true after the state transition, resulting in two successive zero crossings.

Validate Chart Semantics

The `BouncingBall` chart meets the design requirements defined in “Guidelines for Continuous-Time Simulation” on page 22-4. In particular, the chart:

- Initializes the local variables `p` and `v` on the default transition.
- Assigns values to the derivatives `p_dot` and `v_dot` in a during action.
- Writes to local variables `p` and `v` in a transition action.
- Does not contain events, inner transitions, event-based temporal logic, or change detection operators.

View Simulation Results

After you run the model, the scope shows the graphs of position and velocity. The position graph exhibits the expected bounce pattern.

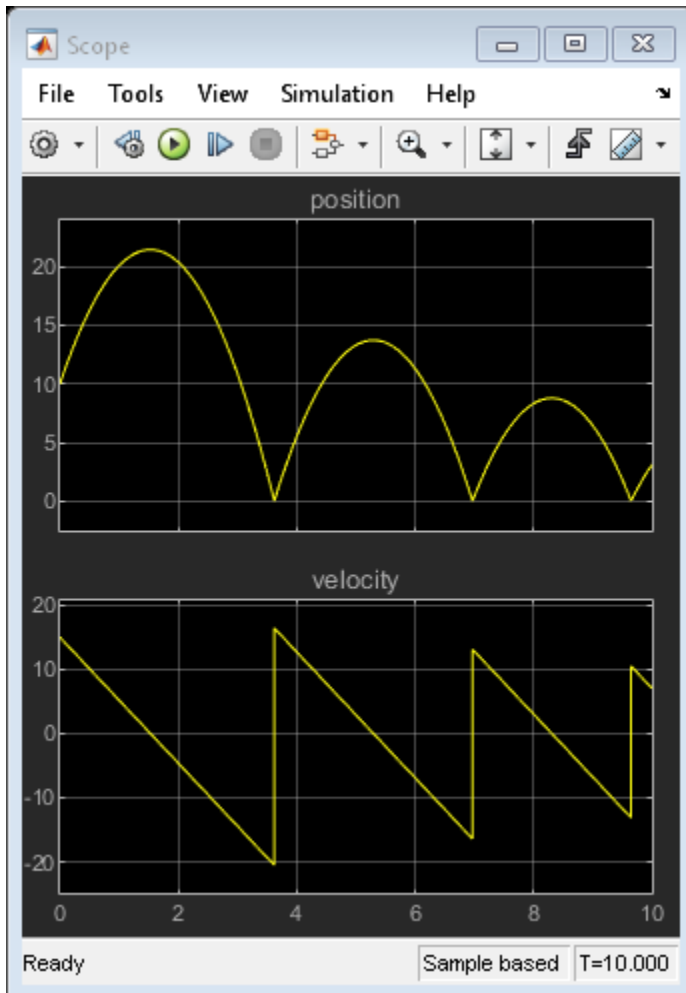

See Also

More About

- “Continuous-Time Modeling in Stateflow” on page 22-2
- “Store Continuous State Information in Local Variables” on page 22-7

Model a DC Motor in Stateflow

This example shows the model of a permanent magnet DC motor. The mode logic and dynamics of the DC motor are both modeled using Stateflow®.

The DC motor state chart consists of two superstates: powerOn and powerOff. If the motor is powered on, it can be in one of two substates: up or down, signifying the direction of movement.

Note: This is a simplistic model of a DC motor. You can build more sophisticated DC motor models using Simscape™, which extends Simulink® with tools for modeling and simulating multidomain physical systems, such as those with mechanical, hydraulic, and electrical components.

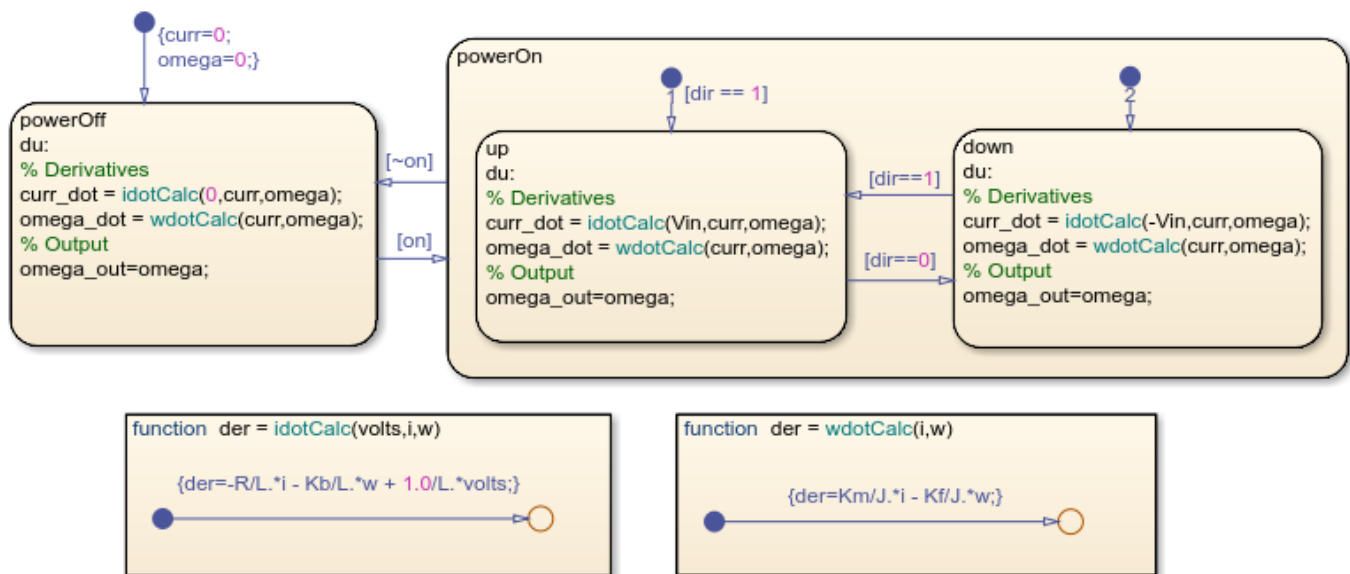

The dynamics of the motor are defined directly in the state chart using graphical functions and change depending on the state of the motor. For example, when the motor is in the powerOff state, the voltage applied is equal to zero. When the motor is in the powerOn state, the voltage applied is either positive or negative, depending on the direction of the motor.

To review, the differential equations defining a permanent magnet DC motor are as follows:

$$\frac{di}{dt} = \frac{v_{app}(t) - R \cdot i(t) - K_b \cdot \omega(t)}{L}$$

$$\frac{d\omega}{dt} = \frac{K_m \cdot i(t) - K_f \cdot \omega(t)}{J}$$

where

i = current

R = resistance

L = inductance

K_b = EMF constant

ω = rotational speed of motor

v_{app} = applied voltage

K_f = damping constant

K_m = torque constant

See Also

More About

- “Continuous-Time Modeling in Stateflow” on page 22-2
- “Reuse Logic Patterns by Defining Graphical Functions” on page 8-13
- “Simscape”

Model the Dynamics of Moving Billiard Balls

This example shows how to model the opening shot in a billiards game by using continuous-time matrix variables. In the model, a Stateflow® chart simulates the dynamics of a hybrid system that has a large number of discontinuities. For more information, see “Continuous-Time Modeling in Stateflow” on page 22-2.

When the simulation starts, a MATLAB® user interface (UI) shows a pool table with 15 billiard balls arranged in a triangular rack. The UI then prompts you to select the initial position and velocity of the cue ball. When the cue ball is released, the UI animates the motion of the billiard balls as they undergo a sequence of rapid collisions.

The model consists of:

- The Stateflow chart `Init`, which calls the function `sf_pool_plotter.m` to initialize the position and velocity of the cue ball based on the input from the UI.
- The Stateflow chart `Pool`, which calculates the two-dimensional dynamics of each billiard ball.
- The MATLAB Function block `Plot`, which calls the function `sf_pool_plotter.m` to animate the motion of the billiard balls during the simulation.
- The Scope block `Vel`, which displays the velocity of each billiard ball during the opening shot.

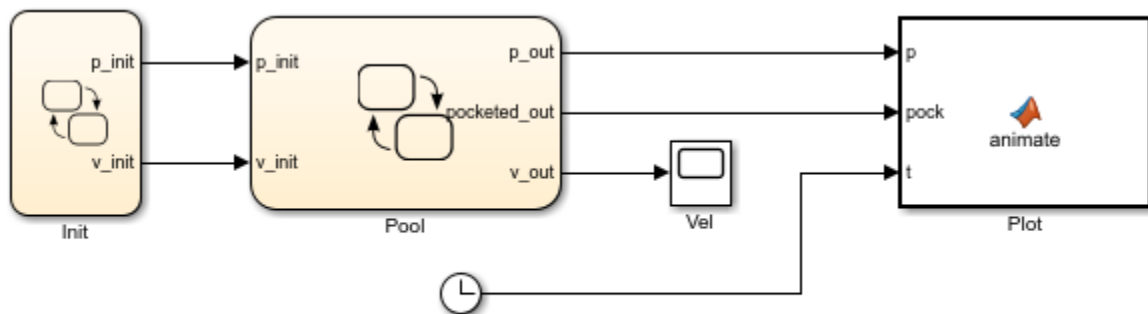

Copyright 2007-2019 The MathWorks, Inc.

Calculate Continuous-Time Dynamics

To represent the dynamics of the billiard balls, the `Pool` chart makes several assumptions.

Continuous-Time Variables

The chart ignores the spin of the balls, so the state of the system is described completely by the positions and velocities of the balls. Each ball is assumed to have unit mass, so its position and velocity are described by the system of differential equations

$$\begin{cases} \dot{\mathbf{p}} = \mathbf{v} \\ \dot{\mathbf{v}} = \mathbf{F}_{\text{friction}} + \mathbf{F}_{\text{interaction}}, \end{cases}$$

where $\mathbf{F}_{\text{friction}}$ and $\mathbf{F}_{\text{interaction}}$ are the forces caused by friction with the pool table and by collisions with other balls.

To track the positions and velocities of the balls, the chart stores a pair of 16-by-2 matrices in the continuous-time variables p and v . In each matrix, the i^{th} row represents the two-dimensional position or velocity of the i^{th} ball.

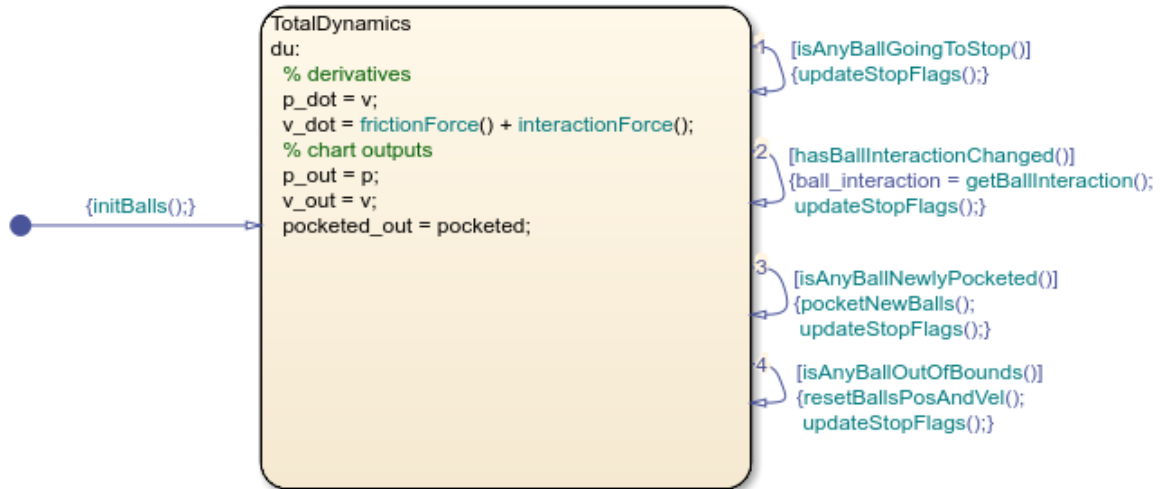

MATLAB Function <code>initBalls</code>	MATLAB Function <code>f = frictionForce</code>	MATLAB Function <code>f = interactionForce</code>
MATLAB Function <code>yn = isAnyBallGoingToStop</code>	MATLAB Function <code>yn = hasBallInteractionChanged</code>	MATLAB Function <code>yn = isAnyBallNewlyPocketed</code>
MATLAB Function <code>yn = isAnyBallOutOfBounds</code>	MATLAB Function <code>yn = nearHole(pp)</code>	MATLAB Function <code>balli = getBallInteraction</code>
MATLAB Function <code>updateStopFlags</code>	MATLAB Function <code>pocketNewBalls</code>	MATLAB Function <code>resetBallsPosAndVel</code>

Friction Model

To calculate the force of friction acting on each ball, the chart calls the MATLAB function `frictionForce`. This function implements a simplified friction model. Friction acts on each moving ball with a constant force opposite to the direction of motion. Because friction does not act on stationary balls, the force of friction on each ball is inherently modal:

$$\mathbf{F}_{\text{friction}} = \begin{cases} -\mu g \frac{\mathbf{v}}{\|\mathbf{v}\|} & \|\mathbf{v}\| > 0 \\ 0 & \text{otherwise,} \end{cases}$$

where μ is the coefficient of friction and g is the acceleration due to gravity.

Collision Dynamics

To determine the interactions caused by collisions between balls, the chart calls the MATLAB function `interactionForce`. This function implements a simple restoring force model when two balls come in contact with each other. The interaction force between the i^{th} and j^{th} balls is modal:

$$\mathbf{F}_{\text{interaction}}(i, j) = \begin{cases} k_p(2R - \|\Delta\mathbf{p}\|) \frac{\Delta\mathbf{p}}{\|\Delta\mathbf{p}\|} - k_v\Delta\mathbf{v} & \|\Delta\mathbf{p}\| < 2R \\ 0 & \text{otherwise,} \end{cases}$$

where:

- R is the radius of each ball.
- k_p and k_v are constants of elasticity.
- $\Delta\mathbf{p} = \mathbf{p}_i - \mathbf{p}_j$ is the relative separation of the centers of the two balls.
- $\Delta\mathbf{v} = \mathbf{v}_i - \mathbf{v}_j$ is the relative difference in velocity between the two balls.

Because the balls are free to move in two dimensions, the chart uses the 16-by-16 Boolean matrix `ball_interaction` to account for all potential collisions. For example, when the i^{th} and j^{th} balls are touching, the value of `ball_interaction(i, j)` is `true`. Otherwise, this value is `false`. Because collisions are symmetric in nature, the chart uses only the upper triangular portion of the matrix.

Perform Matrix Calculations in MATLAB Functions

To compute the two-dimensional dynamics of the billiard balls, the Pool chart calls several MATLAB functions that perform matrix calculations.

- `initBalls` initializes the position and velocity of every ball on the pool table.
- `frictionForce` calculates the friction force acting on each ball.
- `interactionForce` calculates the interaction force acting on each ball.
- `isAnyBallGoingToStop` returns a value of 1 if any ball stops moving. Otherwise, the function returns a value of 0.
- `hasBallInteractionChanged` returns a value of 1 if any ball interactions change. Otherwise, the function returns a value of 0.
- `isAnyBallNewlyPocketed` returns a value of 1 if any ball falls in a pocket. Otherwise, the function returns a value of 0.
- `isAnyBallOutOfBounds` returns a value of `true` if any ball lies outside the boundary of the pool table. Otherwise, the function returns a value of `false`.
- `nearHole` returns a value of `true` if a ball is near a pocket on the pool table. Otherwise, the function returns a value of `false`.
- `getBallInteraction` returns a Boolean matrix that specifies whether any balls are in contact with each other.
- `updateStopFlags` keeps track of which balls have stopped moving and stores the result in the vector `stopped`.
- `pocketNewBalls` sets the velocity of each pocketed ball to 0.
- `resetBallsPosAndVel` resets the position and velocity of any ball that lies outside the boundary of the pool table.

View the Simulation Results

When you start the simulation, a UI shows a pool table with 15 billiard balls arranged at one end of the table. To specify the initial position of the cue ball, click anywhere on the pool table.

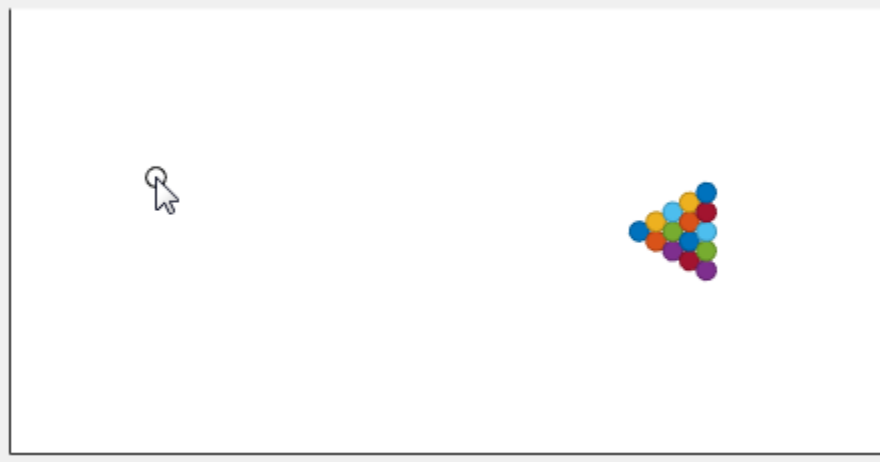

To specify the initial velocity of the cue ball, click a different spot on the pool table.

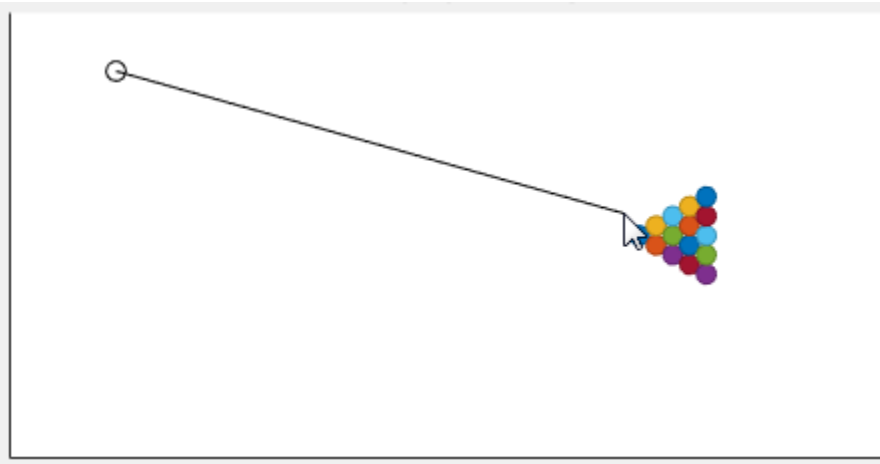

The model simulates the dynamics of the system and animates the motion of the billiard balls.

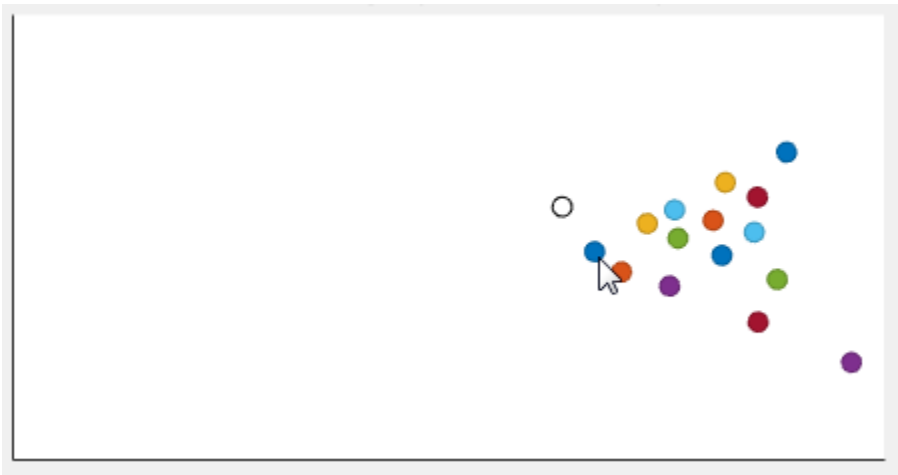

To stop the simulation, close the UI.

See Also

More About

- “Continuous-Time Modeling in Stateflow” on page 22-2
- “Vectors and Matrices in Stateflow Charts” on page 18-2
- “Supported Operations for Vectors and Matrices” on page 18-4
- “Reuse MATLAB Code by Defining MATLAB Functions” on page 29-2

Model Newton's Cradle

This example shows how to model a popular toy called "Newton's cradle" which consists of a row of seven identical balls which are hung from a common height. At rest they are arranged such that they just touch each other. One or more balls from one end are then raised from their rest position and released.

An interesting consequence of elastic collisions between the balls is that the balls which are released seem to come to a stop and an equal number of balls from the other end get released (with almost the same energy as the incoming balls). The balls in the middle do not seem to move, although they are responsible for transferring momentum from one end to another.

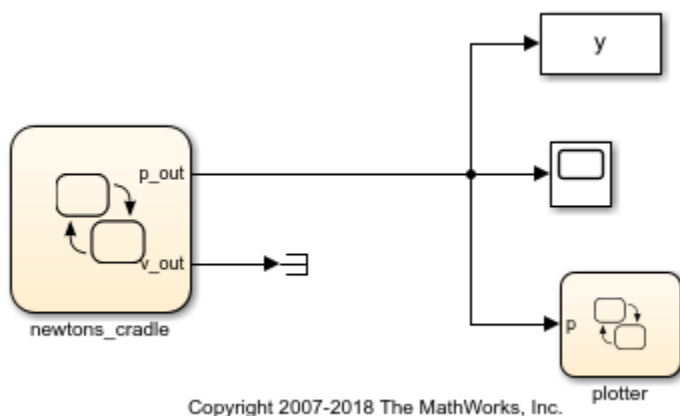

This model uses a simple elastic collision model to describe the interactions between the balls. The Stateflow® chart uses local variables to depict the continuous states of the system, namely the position p and the velocity v . Note that both these local variables are defined to have **Update method** as **continuous**. This allows you to refer to their derivatives as p_dot and v_dot respectively. Since the nominal dynamics of all the balls are identical, vector assignments describe them en-masse as:

```
p_dot = v;
v_dot = -g/l*sin(p);
```

Note that p_dot and v_dot are not chart local variables. They are automatically created because p and v are defined to be continuous.

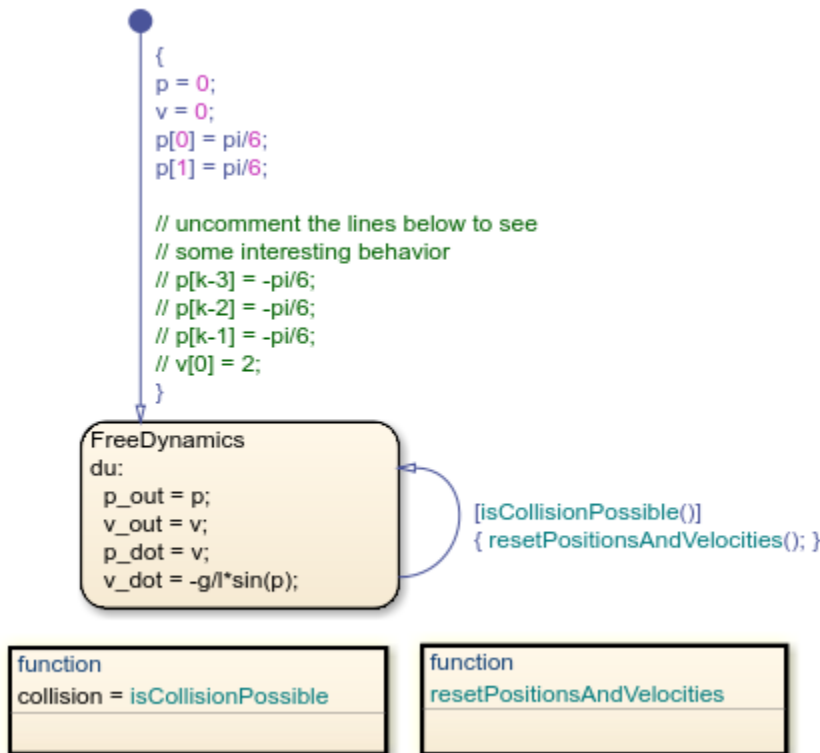

The model uses a simple for-loop to detect collisions between balls. In a one-dimensional setting, the chart only models collisions between successive balls with a single for loop.

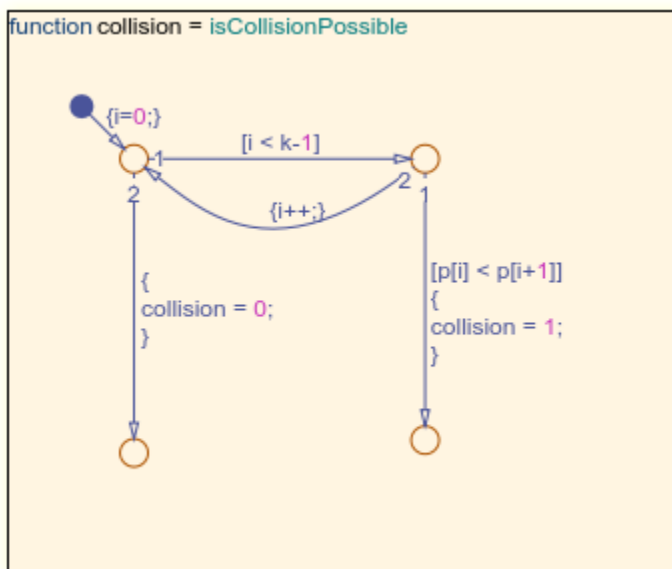

The response to a collision is also expressed simply. Each collision is treated as a perfectly elastic instantaneous collision. The position and velocity are exchanged for each of the balls involved in the collision.

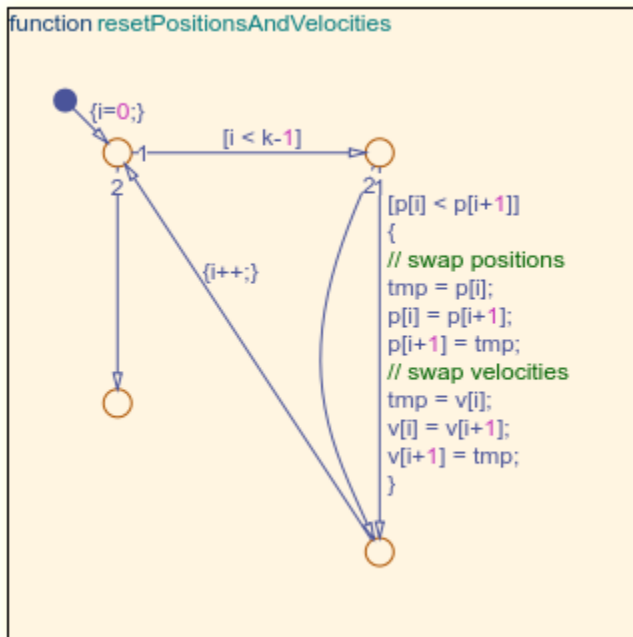

Simulating this model brings up a simple UI that shows the motion of the balls.

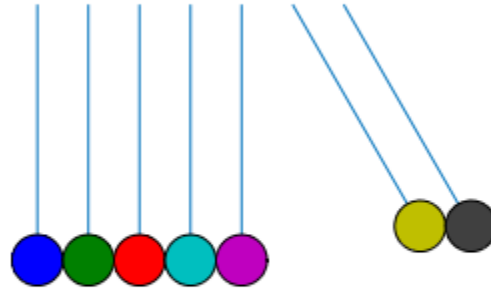

See Also

More About

- “Continuous-Time Modeling in Stateflow” on page 22-2
- “Reuse Logic Patterns by Defining Graphical Functions” on page 8-13
- “Modeling Newton's Cradle with Virtual Reality” on page 22-24

Modeling Newton's Cradle with Virtual Reality

This example shows how to model a popular toy called "Newton's cradle" which consists of a row of seven identical balls which are hung from a common height. At rest they are arranged such that they just touch each other. One or more balls from one end are then raised from their rest position and released.

An interesting consequence of elastic collisions between the balls is that the balls which are released seem to come to a stop and an equal number of balls from the other end get released (with almost the same energy as the incoming balls). The balls in the middle do not seem to move, although they are responsible for transferring momentum from one end to another.

This example uses a simple elastic collision model to describe the interactions between the balls. The Stateflow® chart uses local variables to depict the continuous states of the system, namely the position p and the velocity v . Note that both these local variables are defined to have **Update method** as `continuous`. This allows you to refer to their derivatives as `p_dot` and `v_dot` respectively. Since the nominal dynamics of all the balls are identical, vector assignments describe them en-masse as:

```
p_dot = v;  
v_dot = -g/l*sin(p);
```

Note that `p_dot` and `v_dot` are not chart local variables. They are automatically created because `p` and `v` are defined to be continuous.

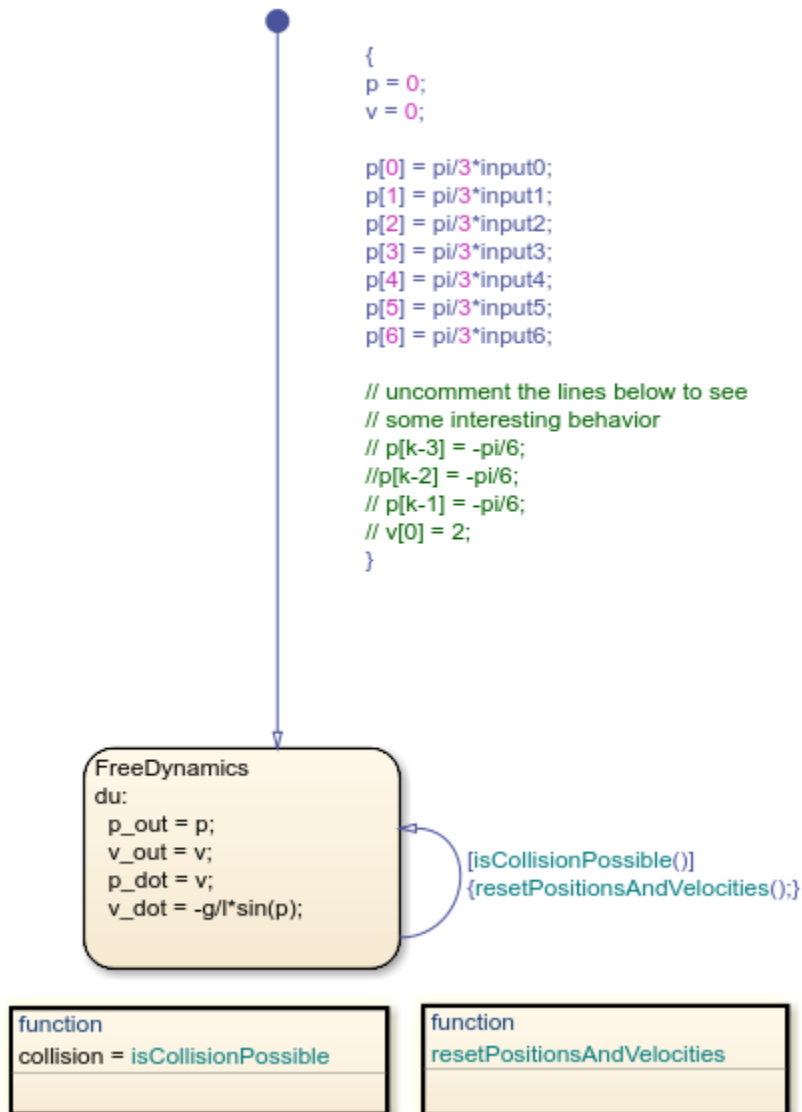

The model uses a simple for-loop to detect collisions between balls. In a one-dimensional setting, the chart only models collisions between successive balls with a single for loop.

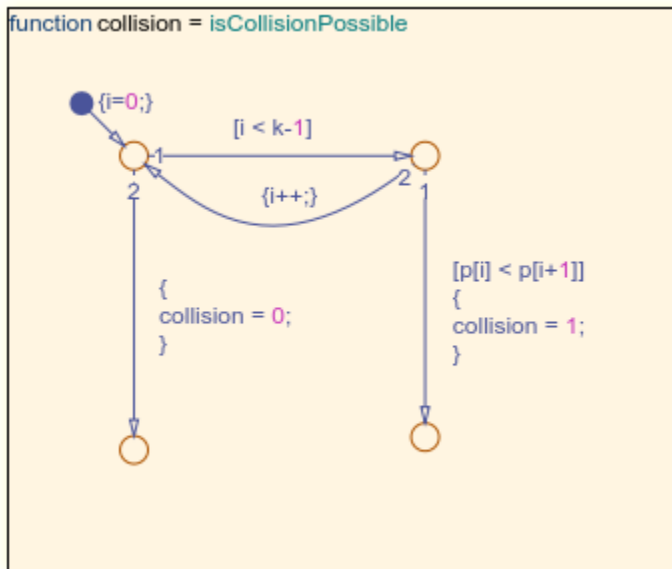

The response to a collision is also expressed simply. Each collision is treated as a perfectly elastic instantaneous collision. The position and velocity are exchanged for each of the balls involved in the collision.

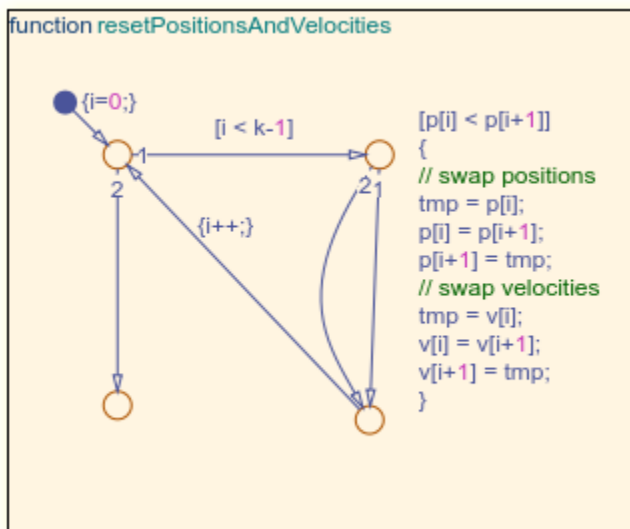

Simulating this model creates a Simulink® 3D Animation™ which shows the motion of the balls. Double-click on any ball to start the simulation.

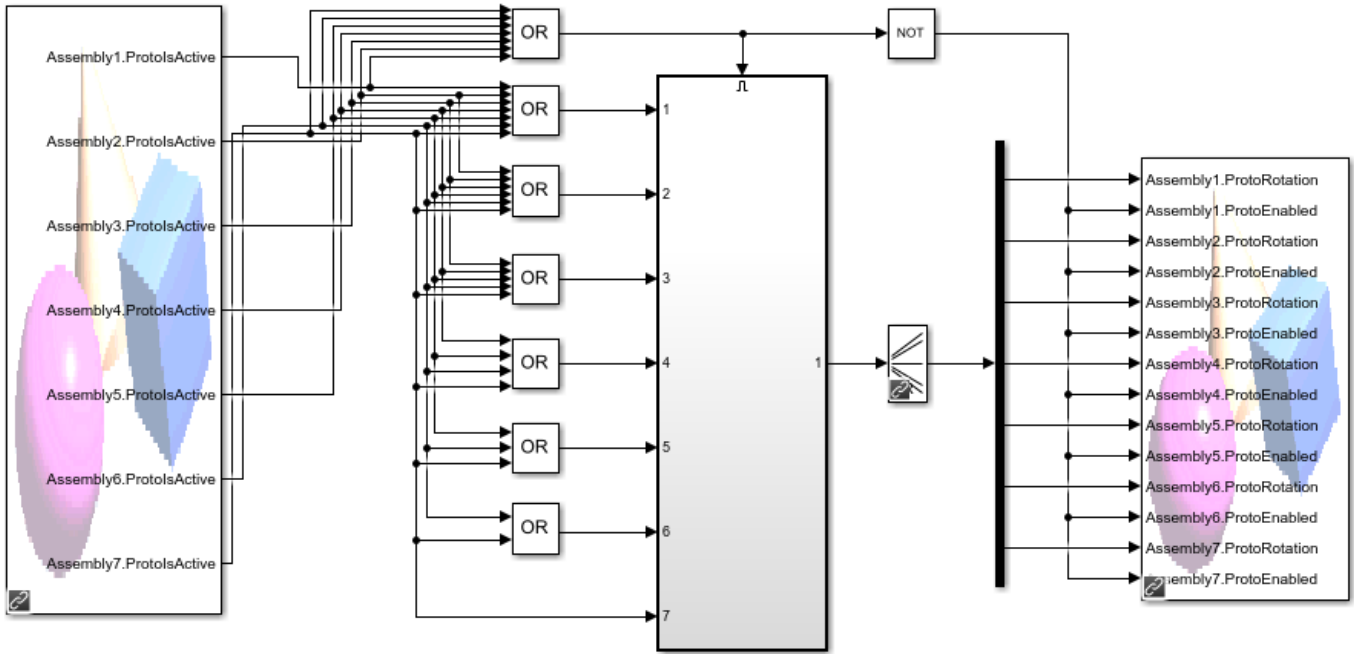

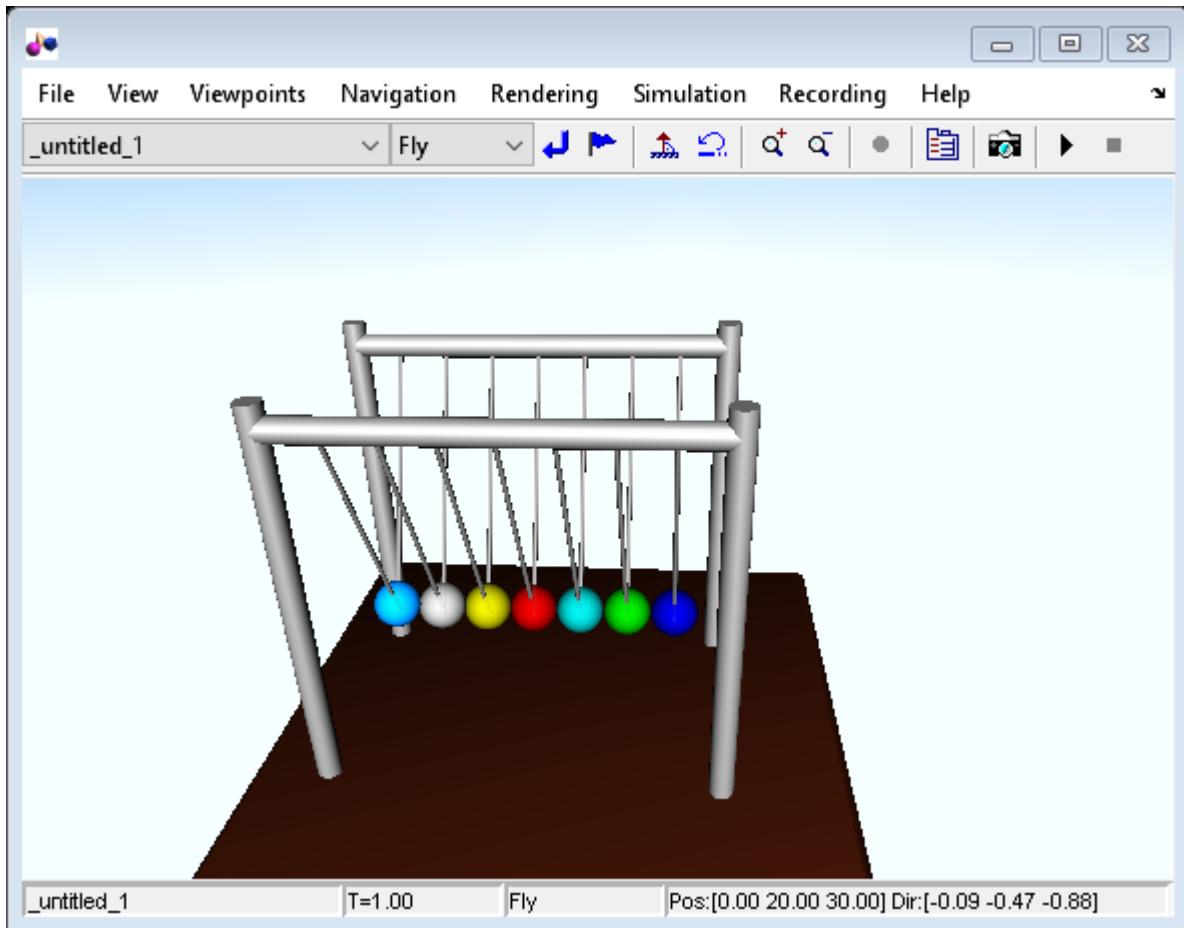

See Also

More About

- “Continuous-Time Modeling in Stateflow” on page 22-2
- “Reuse Logic Patterns by Defining Graphical Functions” on page 8-13
- “Model Newton's Cradle” on page 22-20
- “Simulink 3D Animation”

Fixed-Point Data in Stateflow Charts

- “Fixed-Point Data in Stateflow Charts” on page 23-2
- “Build a Low-Pass Filter by Using Fixed-Point Data” on page 23-8
- “Supported Operations for Fixed-Point Data” on page 23-12
- “Fixed-Point Operations in Stateflow Charts” on page 23-19

Fixed-Point Data in Stateflow Charts

Fixed-point numbers use integers and integer arithmetic to approximate real numbers. They are an efficient means for performing computations involving real numbers without requiring floating-point support in underlying system hardware.

Fixed-Point Numbers

Fixed-point numbers represent real numbers by using the encoding scheme:

$$V \approx V_{approx} = SQ + B.$$

- V is a precise real-world value that you want to approximate with a fixed-point number.
- V_{approx} is the approximate real-world value that results from the fixed-point representation.
- Q is an integer that encodes the fixed-point number. This value is called the *quantized integer*.
- S is a coefficient that determines the precision of the fixed-point representation. This value is called the *slope*.
- B is an additive correction called the *bias*.

The quantized integer Q is the only part of the fixed-point representation that varies in value. In the generated code, the quantities S and B are constant and appear only as literal numbers or expressions. If a fixed-point number changes, its quantized integer Q changes but S and B remain unchanged.

To determine the quantized integer Q corresponding to a real-world value V , round the quantity $(V - B)/S$ to an integer. For example, to represent the number $V = 15.345$ in a fixed-point type with slope $S = 0.5$ and bias $B = 0.1$, you use the quantized integer

$$Q = \text{round}((V - B)/S) = \text{round}((15.345 - 0.1)/0.5) = \text{round}(30.49) = 30.$$

Because you round Q to an integer, you lose some precision in representing the number 15.345. The number that Q actually represents is

$$V_{approx} = SQ + B = 0.5 \square 30 + 0.1 = 15.1.$$

Using fixed-point numbers to represent real numbers with integers involves the loss of some precision. However, with a suitable choice of S and B , you can minimize this loss to acceptable levels. For instance, by changing the coding scheme to use $S = 0.25$ and $B = 0.1$, you can represent the number $V = 15.345$ with greater precision as:

$$Q = \text{round}((V - B)/S) = \text{round}((15.345 - 0.1)/0.25) = \text{round}(60.98) = 61$$

$$V_{approx} = SQ + B = 0.25 \square 61 + 0.1 = 15.35.$$

The difference between V_{approx} and V is always less than the slope S .

Specify Fixed-Point Data

In the Model Explorer, you can specify the fixed-point encoding for a data object by using the Data Type Assistant, as described in “Fixed-Point Data Properties” on page 9-9. Set the **Mode** field to **Fixed point** and specify these properties:

- **Signedness:** Choose **Signed** or **Unsigned**.
- **Word length:** Specify the bit size of the word that holds the quantized integer Q .
- **Scaling:** Choose **Binary point** or **Slope and bias**.

- If you select **Binary point**, the Data Type Assistant displays the **Fraction length** field, which specifies the binary point location. Choosing a **Fraction length** of n defines a fixed-point encoding with a slope of $S = 2^{-n}$ and a bias of $B = 0$.

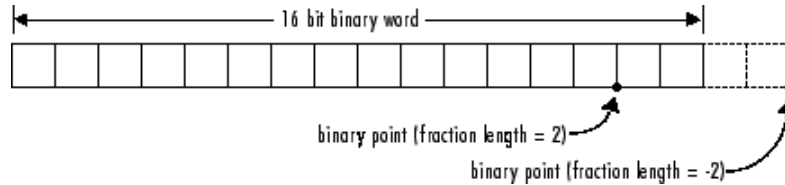

- If you select **Slope and bias**, the Data Type Assistant displays fields for entering the **Slope** S and **Bias** B for the fixed-point encoding scheme.

Alternatively, you can specify the encoding for a fixed-point data object directly by using the `fixdt` function. In the Property Inspector or the Model Explorer, in the **Type** field, enter an expression in one of these formats:

```
fixdt(Signed, WordLength, FractionLength)
```

```
fixdt(Signed, WordLength, Slope, Bias)
```

Tip: Some encoding schemes are computationally expensive, particularly in multiplication and division operations. Selecting a slope that is an integer power of two and a zero bias avoids these computationally expensive instructions. Using binary point scaling is recommended.

Conversion Operations

Stateflow charts convert real numbers into fixed-point numbers during data initialization and as part of casting operations in the application. These conversions compute a quantized integer Q from a real number input. The type of conversion depends on the action language for the chart.

Conversion in Charts That Use MATLAB as the Action Language

In a chart that uses MATLAB as the action language, you define the method for all conversions through the fixed-point properties for the chart. See “Fixed-Point Properties” on page 25-6.

For example, if you set the **MATLAB Chart fimath** property to **Same as MATLAB**, then the chart rounds the resulting quantized integer to its nearest integer value.

Conversions in Charts That Use C as the Action Language

Charts that use C as the action language employ two methods for converting fixed-point data:

- Offline conversions initialize data during code generation. Offline conversions are designed to maximize accuracy. These conversions round the resulting quantized integer to its nearest integer value. Offline conversions are performed for initialization of data (variables and constants) in the Stateflow hierarchy and from the MATLAB workspace.
- Online conversions perform casting operations during run time. Online conversions are designed to maximize computational efficiency. They are faster and more efficient, but less precise than offline conversions. Instead of rounding Q to its nearest integer, online conversions round to the floor (except for division, which can round to 0, depending on the C compiler).

For example, this table illustrates the difference between offline and online conversions of real numbers to fixed-point numbers defined with a slope of $S = 2^{-4}$ and a bias of $B = 0$. For each real-world value V , the chart computes a quantized integer Q by rounding $(V-B)/S$ to the nearest integer (in offline conversion) or to the floor (in online conversion). For each conversion, $V_{approx} = QS + B$ is the approximate real-world value resulting from Q .

Real-World Value		Offline Conversion		Online Conversion	
V	$(V-B)/S$	Q	V_{approx}	Q	V_{approx}
15.345	245.52	246	15.375	245	15.3125
3.45	55.2	55	3.4375	55	3.4375
1.0375	16.6	17	1.0625	16	1
2.06	32.96	33	2.0625	32	2

Fixed-Point Context-Sensitive Constants

In charts that use C as the action language, you can avoid explicit type casts by using fixed-point context-sensitive constants. These constants infer their type from the context in which they occur. They are written like ordinary numbers with the suffix C or c. For example, 4.3C and 123.4c are valid fixed-point context-sensitive constants that you can use in action statements.

Although fixed-point context-sensitive constants can appear in expressions with any data types (including integers and floating-point data), their main use is with fixed-point numbers. The algorithm that interprets the context-sensitive constant computes a type that provides maximum accuracy without overflow. The algorithm depends on:

- The operations in the expression
- The other data types in the context
- The value of the constant

Fixed-point context-sensitive constants infer their type according to these rules:

- In a casting operation, the constant has the type to which it is being cast.
- In a simple assignment operation of the form $a = b$:
 - If b is a context-sensitive constant, it has the same type as a .
 - If b is an addition or subtraction operation, then the constant has the same type as the other operand.
 - If b is a multiplication or division operation with a fixed-point operand, then the constant has the type that provides the best possible precision for a fixed-point result, as determined by the `fixptbestexp` function.
 - If b is a multiplication or division operation with a floating-point operand of type `double` or `single`, then the constant has the same type as the floating-point operand.
- In a special assignment operation of the form $a := b$:
 - If b is a context-sensitive constant, it has the same type as a .
 - If b is an arithmetic operation with a floating-point operand of type `double` or `single`, or if a is a floating-point data object, then the constant has the same type as the floating-point number.

- If **b** is an addition or subtraction operation with a fixed-point operand and **a** is a fixed-point data object, then the constant has the same type as **a**.
- If **b** is a multiplication or division operation with a fixed-point operand and **a** is a fixed-point data object, then the constant has the type that provides the best possible precision for a fixed-point result.
- As an argument in a function call, the constant has the same type as the formal argument.

You cannot use context-sensitive constants as both operands of a binary operation or as the leftmost operand of an assignment operation.

Tips for Using Fixed-Point Data

- Develop and test your application by using double- or single-precision floating-point numbers. Using double- or single-precision floating-point numbers does not limit the range or precision of your computations. Once your application works as designed, you can start substituting fixed-point data for double-precision data.
- In the Model Configuration Parameters dialog box, on the **Hardware Implementation** pane, set the integer word size for the simulation environment to the integer size of the intended target environment. Code generated by Stateflow uses this integer size to select result types for your fixed-point operations. See “Hardware Implementation Pane” (Simulink).
- When you simulate your model, use overflow detection to warn you when the result of a fixed-point operation exceeds the numeric capacity of its fixed-point type. In the Model Configuration Parameters dialog box, on the **Diagnostics > Data Validity** pane, set **Wrap on overflow** and **Saturate on overflow** to error or warning. If you encounter overflow errors in fixed-point data, increase the range of your data by:
 - Increasing the **Word length** value for the overflowing fixed-point data. For example, change the number of bits used to encode the fixed-point data from 16 to 32. This action changes the base integer type for *Q* from `int16` to `int32`.
 - Decreasing the **Fraction length** value (if using **Binary point scaling**) or increasing the **Slope** value (if using **Slope and bias scaling**). For example, decrease the **Fraction length** value from 4 to 1 (or, equivalently, increase the **Slope** value from $S = 2^{-4} = 0.0625$ to $S = 2^{-1} = 0.5$). This action increases the range of your fixed-point data but decreases the available precision.

For more information, see “Data Range Violations” on page 33-36.

- If you encounter issues with model behavior stemming from inadequate precision in your fixed-point data, increase the precision of your data by increasing the **Fraction length** value (if using **Binary point scaling**) or decreasing the **Slope** value (if using **Slope and bias scaling**). For example, increase the **Fraction length** value from 2 to 3 (or, equivalently, decrease the **Slope** value from $S = 2^{-2} = 0.25$ to $S = 2^{-3} = 0.125$). This action increases the precision of your fixed-point data but decreases the available range.
- In charts that use C as the action language, you can use a special assignment operation `:=` and context-sensitive constants to maintain as much precision as possible. See “Override Fixed-Point Promotion in C Charts” on page 23-15 and “Fixed-Point Context-Sensitive Constants” on page 23-4.

Note If you do not use context-sensitive constants with fixed-point types, noninteger numeric constants (constants that have a decimal point) can force fixed-point operations to produce floating-point results.

Automatic Scaling of Fixed-Point Data

Automatic scaling tools can change the settings of Stateflow fixed-point data. You can prevent automatic scaling by selecting the **Lock data type setting against changes by the fixed-point tools** option for the fixed-point data object. See “Lock Data Type Against Fixed-Point Tools” on page 9-8. For methods on autoscaling fixed-point data, see “Choosing a Range Collection Method” (Fixed-Point Designer).

Share Fixed-Point Data with Simulink Models

To share fixed-point data with Simulink models:

- Use the same property values to specify the data in the Stateflow chart and in the Simulink model. For an example of this method of sharing input data from a Simulink model, see “Model Bang-Bang Temperature Control System”.

For some Simulink blocks, you can specify the type of input or output data directly. For example, you can specify the fixed-point data type for a Constant block directly in the **Output data type** field by using the `fixdt` function.

- Define the data as **Input** or **Output** in the Stateflow chart and instruct the sending or receiving block in the Simulink model to inherit its type from the chart data. In many blocks, you can set data types through inheritance from the driving block, or through back propagation from the next block. You can set the data type of a Simulink block to match the data type of the Stateflow port to which it connects.

For example, you can set the Constant block to inherit its type from the Stateflow **Input to Simulink** port that it supplies. Set the **Output data type** block parameter to `Inherit via back propagation`.

Implementation of Fixed-Point Data in Stateflow

Stateflow charts define fixed-point data types from the values that you specify for S , B , and the base integer type for Q .

- For each fixed-point data, the chart defines an integer variable for Q in the generated code. This integer is the only part of a fixed-point number that changes in value. The available base types for Q are the unsigned integer types `uint8`, `uint16`, and `uint32`, and the signed integer types `int8`, `int16`, and `int32`. If a fixed-point number has a slope $S = 1$ and a bias $B = 0$, it is equivalent to its quantized integer Q and behaves exactly as its base integer type.
- The slope S is factored into a coefficient F with $1 \leq F < 2$ and an integer power of two with exponent E :

$$S = F \square 2^E.$$

If the fractional slope F is greater than 1, it is converted into a fixed-point number. Encoding schemes with $F > 1$ can be computationally expensive, particularly in multiplication and division operations. Setting $F = 1$ avoids these computationally expensive instructions. In this setting, scaling by a power of 2 is implemented as bit shifts, which are more efficient than multiply instructions. Therefore, using binary-point-only scaling, in which $F = 1$ and $B = 0$, is recommended.

- Operations for fixed-point types are implemented with solutions for the quantized integer as described in “Arithmetic Operations for Fixed-Point Data” on page 23-19. To generate efficient code, the fixed-point promotion rules choose values for slope and bias that cancel difficult terms in the solutions. See “Promotion Rules for Fixed-Point Operations” on page 23-20.

See Also

`fixdt` | `fixptbestexp`

More About

- “Fixed-Point Operations in Stateflow Charts” on page 23-19
- “Supported Operations for Fixed-Point Data” on page 23-12
- “Build a Low-Pass Filter by Using Fixed-Point Data” on page 23-8
- “Set Data Properties” on page 9-5

Build a Low-Pass Filter by Using Fixed-Point Data

This example shows how to build a Stateflow® chart that uses fixed-point data to implement a low-pass Butterworth filter. By designing the filter with fixed-point data instead of floating-point data, you can simulate your model using less memory. For more information, see “Fixed-Point Data in Stateflow Charts” on page 23-2.

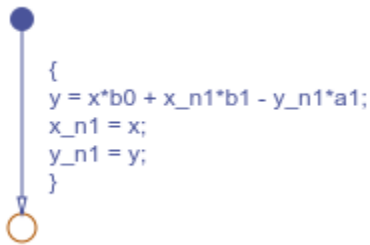

Build the Fixed-Point Butterworth Filter

The Low-Pass Filter chart is a stateless flow chart that accepts one input and provides one output. The chart contains these data symbols:

- **x** — **Scope:** Input, **Type:** Inherit:Same as Simulink
- **y** — **Scope:** Output, **Type:** fixdt(1,16,10)
- **x_n1** — **Scope:** Local, **Type:** fixdt(1,16,12)
- **y_n1** — **Scope:** Local, **Type:** fixdt(1,16,10)
- **b0** — **Scope:** Parameter, **Type:** fixdt(1,16,15)
- **b1** — **Scope:** Parameter, **Type:** fixdt(1,16,15)
- **a1** — **Scope:** Parameter, **Type:** fixdt(1,16,15)

The values of **b0**, **b1**, and **a1** are the coefficients of the low-pass Butterworth filter.

To build the Low-Pass Filter chart:

- 1 Create a Simulink® model with an empty Stateflow chart by entering `sfnew` at the MATLAB® command prompt.
- 2 In the Stateflow chart, add a flow chart with a single branch that assigns values to **y**, **x_n1**, and **y_n1**.
- 3 Add input, output, local, and parameter data to the chart, as described in “Add Stateflow Data” on page 9-2.

Define the Model Callback Function

Before loading the model, MATLAB calls the `butter` function to compute the values for the parameters **b0**, **b1**, and **a1**. The function constructs a first-order low-pass Butterworth filter with a normalized cutoff frequency of $(2*\pi*F_c/(F_s/2))$ radians per second, where:

- The sampling frequency is $F_s = 1000$ Hz.
- The cutoff frequency is $F_c = 50$ Hz.

The function output **B** contains the numerator coefficients of the filter in descending powers of **z**. The function output **A** contains the denominator coefficients of the filter in descending powers of **z**.

```

Fs = 1000;
Fc = 50;
[B,A] = butter(1,2*pi*Fc/(Fs/2));
b0 = B(1);
b1 = B(2);
a1 = A(2);

```

To define the preload callback for the model:

- 1 In the **Modeling** tab, under **Setup**, select **Model Settings > Model Properties**.
- 2 In the Model Properties dialog box, on the **Callbacks** tab, select **PreLoadFcn**.
- 3 Enter the MATLAB code for the preload function call.
- 4 Click **OK**.

To load the parameter values to the MATLAB workspace, save, close, and reopen the model.

Add Other Blocks to the Model

To complete the model, add a Sine Wave block, a Data Type Conversion block, and a Scope block. Connect and label the blocks according to this diagram.

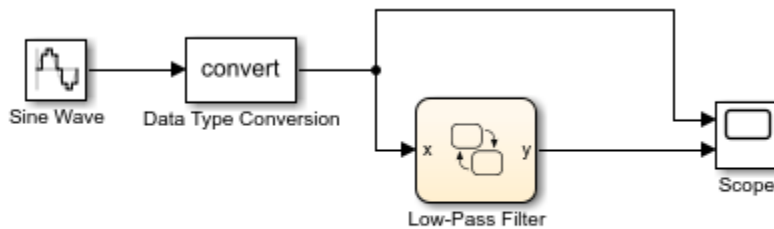

Copyright 2018-2020 The MathWorks, Inc.

Sine Wave block

The Sine Wave block outputs a floating-point signal. The block has these settings:

- **Sine type:** Time based
- **Time:** Use simulation time
- **Amplitude:** 1
- **Bias:** 0
- **Frequency:** $2 \cdot \pi \cdot F_c$
- **Phase:** 0
- **Sample time:** $1/F_s$
- **Interpret vector parameters as 1-D:** On

Data Type Conversion block

The Data Type Conversion block converts the floating-point signal from the Sine Wave block to a fixed-point signal. By converting the signal to a fixed-point type, you can simulate your model using less memory. The block has these settings:

- **Output minimum:** []
- **Output maximum:** []
- **Output data type:** `fixdt(1,16,14)`
- **Lock output data type setting against changes by the fixed-point tools:** Off
- **Input and output to have equal:** Real World Value (RWV)
- **Integer rounding mode:** Floor
- **Saturate on integer overflow:** Off
- **Sample time:** -1

Scope block

The Scope block has two input ports that connect to the input and output signals for the Low-Pass Filter chart. To display the two signals separately, select a scope layout with two rows and one column.

Set Model Configuration Parameters

Because none of the blocks in the model have a continuous sample time, use a discrete solver with these configuration parameters:

- **Stop time:** 0.1
- **Type:** Fixed-step
- **Solver:** discrete (no continuous states)
- **Fixed-step size (fundamental sample time):** 1/Fs

To configure the model:

- 1 In the Stateflow Editor, select **Simulation > Model Configuration Parameters**.
- 2 In the **Solver** pane, set the discrete solver parameters.
- 3 Click **OK**.

Run the Model

When you simulate the model, the Scope block displays two signals. The top signal shows the fixed-point version of the sine wave input to the chart. The bottom signal corresponds to the filtered output from the chart. The filter removes high-frequency values from the signal but allows low-frequency values to pass through the chart unchanged.

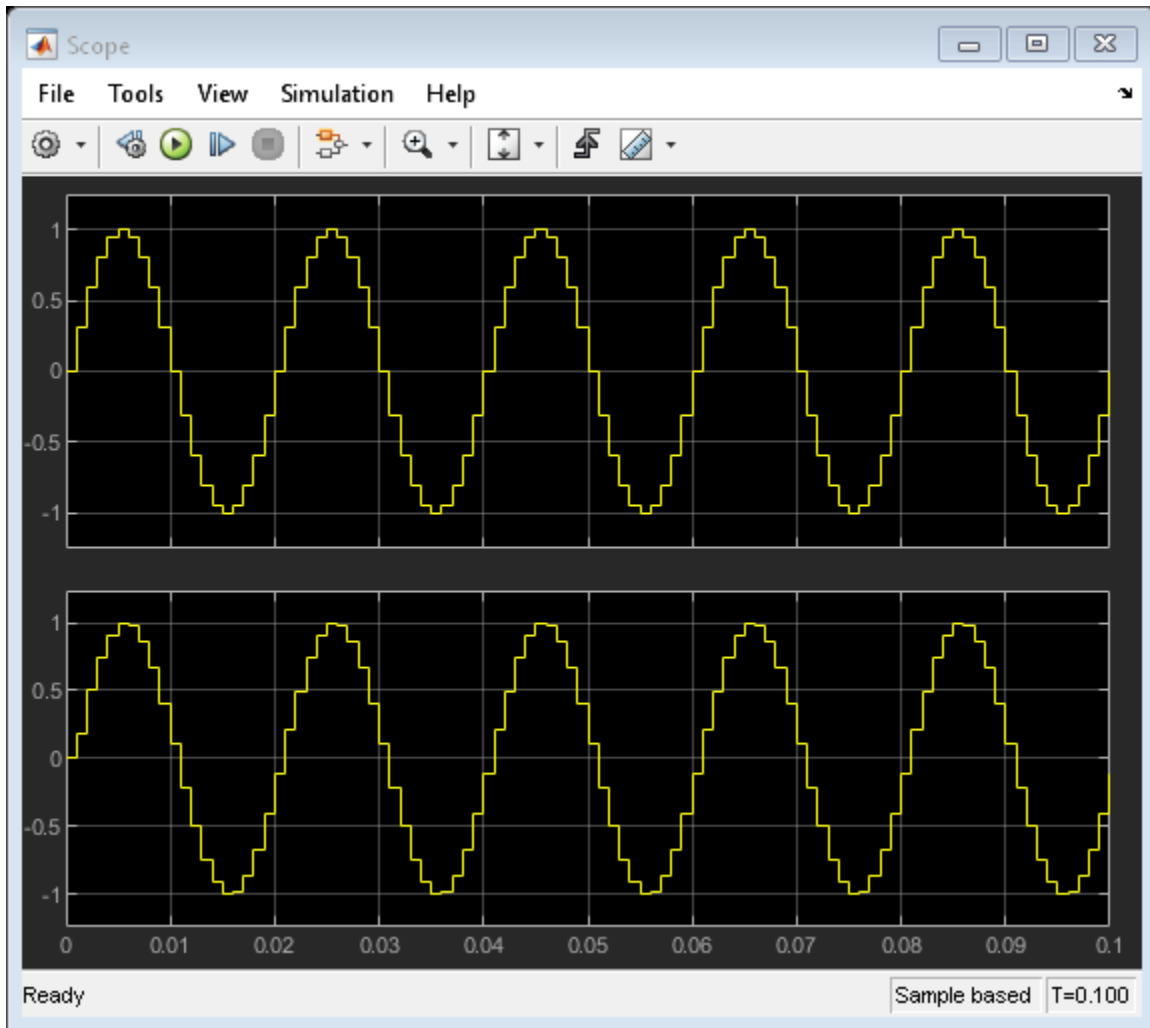

See Also



Data Type Conversion | Scope | Sine Wave | butter | sfnew

More About

- "Fixed-Point Data in Stateflow Charts" on page 23-2
- "Fixed-Point Operations in Stateflow Charts" on page 23-19
- "Supported Operations for Fixed-Point Data" on page 23-12

Supported Operations for Fixed-Point Data

Stateflow charts in Simulink models have an action language property that defines the syntax that you use to compute with fixed-point data:

-  MATLAB as the action language.
-  C as the action language.

For more information, see “Differences Between MATLAB and C as Action Language Syntax” on page 14-5.

Binary Operations

This table summarizes the interpretation of all binary operations on fixed-point operands according to their order of precedence (0 = highest, 9 = lowest). Binary operations are left associative so that, in any expression, operators with the same precedence are evaluated from left to right.

Operation	Precedence	MATLAB as the Action Language	C as the Action Language
$a \wedge b$	0	Power. Not supported for fixed-point operands defined by using either a slope that is not an integer power of two or a nonzero bias. Exponent operand must be a constant whose value is a non-negative integer.	Power. Enable this operation by clearing the Enable C-bit operations chart property. See “Enable C-Bit Operations” on page 25-4.
$a * b$	1	Multiplication. For fixed-point operands defined by using either a slope that is not an integer power of two or a nonzero bias, specify a chart <code>fimath</code> object with <code>ProductMode</code> set to <code>SpecifyPrecision</code> . See “Multiplication” on page 23-22.	Multiplication. Not supported for fixed-point operands defined by using a nonzero bias. See “Multiplication” on page 23-22.
a / b	1	Division. Not supported for fixed-point operands defined by using either a slope that is not an integer power of two or a nonzero bias. See “Division” on page 23-22.	Division. Not supported for fixed-point operands defined by using a nonzero bias. See “Division” on page 23-22.
$a + b$	2	Addition. For fixed-point operands defined by using either a slope that is not an integer power of two or a nonzero bias, specify a chart <code>fimath</code> object with <code>SumMode</code> set to <code>SpecifyPrecision</code> . See “Addition and Subtraction” on page 23-21.	Addition. See “Addition and Subtraction” on page 23-21.

Operation	Precedence	MATLAB as the Action Language	C as the Action Language
$a - b$	2	Subtraction. For fixed-point operands defined by using either a slope that is not an integer power of two or a nonzero bias, specify a chart <code>fimath</code> object with <code>SumMode</code> set to <code>SpecifyPrecision</code> . See “Addition and Subtraction” on page 23-21.	Subtraction. See “Addition and Subtraction” on page 23-21.
$a > b$	3	Comparison, greater than. See “Relational Operations for Fixed-Point Data” on page 23-19.	Comparison, greater than. Not supported for fixed-point operands with mismatched biases. See “Relational Operations for Fixed-Point Data” on page 23-19.
$a < b$	3	Comparison, less than. See “Relational Operations for Fixed-Point Data” on page 23-19.	Comparison, less than. Not supported for fixed-point operands with mismatched biases. See “Relational Operations for Fixed-Point Data” on page 23-19.
$a \geq b$	3	Comparison, greater than or equal to. See “Relational Operations for Fixed-Point Data” on page 23-19.	Comparison, greater than or equal to. Not supported for fixed-point operands with mismatched biases. See “Relational Operations for Fixed-Point Data” on page 23-19.
$a \leq b$	3	Comparison, less than or equal to. See “Relational Operations for Fixed-Point Data” on page 23-19.	Comparison, less than or equal to. Not supported for fixed-point operands with mismatched biases. See “Relational Operations for Fixed-Point Data” on page 23-19.
$a == b$	4	Comparison, equal to. See “Relational Operations for Fixed-Point Data” on page 23-19.	Comparison, equal to. Not supported for fixed-point operands with mismatched biases. See “Relational Operations for Fixed-Point Data” on page 23-19.
$a \neq b$	4	Comparison, not equal to. See “Relational Operations for Fixed-Point Data” on page 23-19.	Comparison, not equal to. Not supported for fixed-point operands with mismatched biases. See “Relational Operations for Fixed-Point Data” on page 23-19.
$a \neq b$	4	Not supported. Use the operation $a \neq b$. See “Relational Operations for Fixed-Point Data” on page 23-19.	Comparison, not equal to. Not supported for fixed-point operands with mismatched biases. See “Relational Operations for Fixed-Point Data” on page 23-19.

Operation	Precedence	MATLAB as the Action Language	C as the Action Language
a <> b	4	Not supported. Use the operation a ~= b. See “Relational Operations for Fixed-Point Data” on page 23-19.	Comparison, not equal to. Not supported for fixed-point operands with mismatched biases. See “Relational Operations for Fixed-Point Data” on page 23-19.
a && b	8	Logical AND. See “Logical Operations for Fixed-Point Data” on page 23-20.	Logical AND. See “Logical Operations for Fixed-Point Data” on page 23-20.
a b	9	Logical OR. See “Logical Operations for Fixed-Point Data” on page 23-20.	Logical OR. See “Logical Operations for Fixed-Point Data” on page 23-20.

Unary Operations and Actions

This table summarizes the interpretation of all unary operations and actions on fixed-point operands. Unary operations:

- Have higher precedence than binary operators.
- Are right associative so that, in any expression, they are evaluated from right to left.

Operation	MATLAB as the Action Language	C as the Action Language
~a	Not supported. Use the expression a == cast(0, 'like', a). See “Logical Operations for Fixed-Point Data” on page 23-20.	Logical NOT. Enable this operation by clearing the Enable C-bit operations chart property. See “Logical Operations for Fixed-Point Data” on page 23-20 and “Enable C-Bit Operations” on page 25-4.
!a	Not supported. Use the expression a == cast(0, 'like', a). See “Logical Operations for Fixed-Point Data” on page 23-20.	Logical NOT. See “Logical Operations for Fixed-Point Data” on page 23-20.
-a	Negative. See “Unary Minus” on page 23-23.	Negative. See “Unary Minus” on page 23-23.
a++	Not supported. Use the expression a = a + 1.	Increment. Equivalent to a = a + 1.
a--	Not supported. Use the expression a = a - 1.	Decrement. Equivalent to a = a - 1.

Assignment Operations

This table summarizes the interpretation of assignment operations on fixed-point operands.

Operation	MATLAB as the Action Language	C as the Action Language
a = b	Simple assignment.	Simple assignment.

Operation	MATLAB as the Action Language	C as the Action Language
$a := b$	Not supported. To override fixed-point promotion rules, use explicit type cast operations. See “Type Cast Operations” on page 13-16.	Special assignment that overrides fixed-point promotion rules. See “Override Fixed-Point Promotion in C Charts” on page 23-15.
$a += b$	Not supported. Use the expression $a = a + b$.	Equivalent to $a = a + b$.
$a -= b$	Not supported. Use the expression $a = a - b$.	Equivalent to $a = a - b$.
$a *= b$	Not supported. Use the expression $a = a * b$.	Equivalent to $a = a * b$.
$a /= b$	Not supported. Use the expression $a = a / b$.	Equivalent to $a = a / b$.

Override Fixed-Point Promotion in C Charts

In charts that use C as the action language, a simple assignment of the form $a = b$ calculates an intermediate value for b according to the fixed-point promotion rules. Then this intermediate value is cast to the type of a by using an online conversion. See “Promotion Rules for Fixed-Point Operations” on page 23-20 and “Conversion Operations” on page 23-3. Simple assignments are most efficient when both types have equal bias and slopes that either are equal or are both powers of two.

In contrast, a special assignment of the form $a := b$ overrides this behavior by initially using the type of a as the result type for the value of b .

- Constants in b are converted to the type of a by using offline conversions.
- The expression b can contain at most one arithmetic operator (+, -, *, or /). The result is determined by using an online conversion.
- If b contains anything other than an arithmetic operation or a constant, then the special assignment operation behaves like the simple assignment operation (=).

Use the special assignment operation $:=$ when you want to:

- Avoid an overflow in an arithmetic operation. For example, see “Avoid Overflow in Fixed-Point Addition” on page 23-15.
- Retain precision in a multiplication or division operation. For example, see “Improve Precision in Fixed-Point Division” on page 23-16.

Note Using the special assignment operation $:=$ can result in generated code that is less efficient than the code you generate by using the normal fixed-point promotion rules.

Avoid Overflow in Fixed-Point Addition

You can use the special assignment operation $:=$ to avoid overflow when performing an arithmetic operation on two fixed-point numbers. For example, consider a chart that computes the sum $a+b$ where $a = 2^{12}-1 = 4095$ and $b = 1$.

Suppose that:

- Both inputs are signed 16-bit fixed-point numbers with three fraction bits (type `fixdt(1,16,3)`).
- The output `c` is a signed 32-bit fixed-point number with three fraction bits (type `fixdt(1,32,3)`).
- The integer word size for production targets is 16 bits.

Because the target integer size is 16 bits, the simple assignment `c = a+b` adds the inputs in 16 bits before casting the sum to 32 bits. The intermediate result is 4096, which, as a type `fixdt(1,16,3)` value, results in an overflow.

In contrast, the special assignment `c := a+b` casts the inputs to 32 bits before computing the sum. The result of 4096 is safely computed as a type `fixdt(1,32,3)` value without an overflow.

Improve Precision in Fixed-Point Division

You can use the special assignment operation `:=` to obtain a more precise result when multiplying or dividing two fixed-point numbers. For example, consider a chart that computes the ratio `a/b` where `a = 2` and `b = 3`.

Suppose that:

- The input `a` is a fixed-point number with four fraction bits (type `fixdt(1,16,4)`).
- The input `b` is a fixed-point number with three fraction bits (type `fixdt(1,16,3)`).
- The output `c` is a signed 16-bit fixed-point number with six fraction bits (type `fixdt(1,16,6)`).

The inputs correspond to these slopes and quantized integers:

$$S_a = 2^{-4}, Q_a = 32$$

$$S_b = 2^{-3}, Q_b = 24.$$

The simple assignment `c = a/b` first calculates an intermediate value for `a/b` according to the fixed-point promotion rules. The quantized integer is rounded to the floor:

$$S_{\text{int}} = S_a/S_b = 2^{-4}/2^{-3} = 2^{-1}$$

$$Q_{\text{int}} = Q_a/Q_b = 32/24 \approx 1.$$

The intermediate result is then cast as a signed 16-digit fixed-point number with six fraction bits:

$$S_c = 2^{-6} = 1/64$$

$$Q_c = S_{\text{int}}Q_{\text{int}}/S_c = 2^{-1}/2^{-6} = 2^5 = 32.$$

Therefore, the approximate real-world value for `c` is $V_c \approx S_c Q_c = 32/64 = 0.5$. This result is not a good approximation of the actual value of `2/3`.

In contrast, the special assignment `c := a/b` calculates `a/b` directly as a signed 16-digit fixed-point number with six fraction bits. Again, the quantized integer is rounded to the floor:

$$S_c = 2^{-6} = 1/64$$

$$Q_c = (S_a Q_a)/(S_c S_b Q_b) = 128/3 \approx 42.$$

Therefore, the approximate real-world value for `c` is $V_c \approx S_c Q_c = 42/64 = 0.6563$. This result is a better approximation to the actual value of `2/3`.

Compare Results of Fixed-Point Arithmetic

This example shows the difference between various implementations of fixed-point arithmetic in Stateflow charts. The model contains three charts that calculate the ratio `a/b` where `a = 19` and `b = 24`. Both inputs are signed 16-digit fixed-point numbers with one fraction bit (type `fixdt(1,16,1)`). They correspond to these slopes and quantized integers:

$$S_a = 2^{-1}, Q_a = 38$$

$$S_b = 2^{-1}, Q_b = 48$$

The model calculates the value of a/b as a floating-point number of type `fixdt(1,16,1)` in three different ways:

- A type casting operation in a chart that uses MATLAB as the action language.
- A simple assignment operation in a chart that uses C as the action language.
- A special assignment operation in a chart that uses C as the action language.

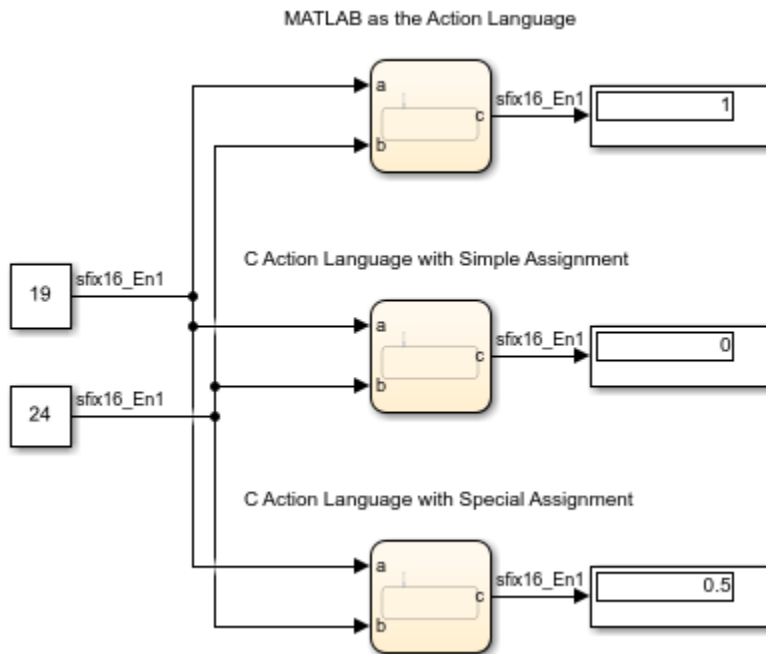

Type Casting in Chart That Uses MATLAB as the Action Language

The chart at the top of the model computes an intermediate value for a/b . The quantized integer for the intermediate value is rounded to the nearest integer:

$$S_{\text{int}} = S_a/S_b = 1$$

$$Q_{\text{int}} = Q_a/Q_b = 38/48 \approx 1.$$

The intermediate value is then cast as a signed 16-digit fixed-point number c with one fraction bit:

$$S_c = 2^{-1}$$

$$Q_c = S_{\text{int}} \cdot Q_{\text{int}}/S_c = 2.$$

The output value from this chart is

$$\tilde{V}_c = S_c \cdot Q_c = 1.$$

Simple Assignment in Chart That Uses C as the Action Language

The middle chart also computes an intermediate value for a/b . In this case, the quantized integer for the intermediate value is rounded to the floor:

$$S_{\text{int}} = S_a/S_b = 1$$

$$Q_{\text{int}} = Q_a/Q_b = 38/48 \approx 0.$$

The intermediate value is then cast as a signed 16-digit fixed-point number c with one fraction bit:

$$S_c = 2^{-1}$$

$$Q_c = S_{\text{int}} \cdot Q_{\text{int}}/S_c = 0.$$

The output value from this chart is

$$\tilde{V}_c = S_c \cdot Q_c = 0.$$

Special Assignment in Chart That Uses C as the Action Language

The chart at the bottom of the model uses a special assignment of the form $c := a/b$. The value of the division is calculated directly as a signed 16-digit fixed-point number with one fraction bit. The quantized integer is rounded to the floor:

$$S_c = 2^{-1}$$

$$Q_c = (S_a \cdot Q_a)/(S_c \cdot S_b \cdot Q_b) = 19/12 \approx 1.$$

Therefore, the output value from this chart is

$$\tilde{V}_c = S_c \cdot Q_c = 0.5.$$

The three results exhibit loss of precision compared to the floating-point answer of $19/24 = 0.7917$. To minimize the loss of precision to an acceptable level in your application, adjust the encoding scheme in your fixed-point data.

See Also**More About**

- “Fixed-Point Data in Stateflow Charts” on page 23-2
- “Fixed-Point Operations in Stateflow Charts” on page 23-19
- “Build a Low-Pass Filter by Using Fixed-Point Data” on page 23-8

Fixed-Point Operations in Stateflow Charts

Fixed-point numbers use integers and integer arithmetic to approximate real numbers. They enable you to perform computations involving real numbers without requiring floating-point support in underlying system hardware. For more information, see “Fixed-Point Data in Stateflow Charts” on page 23-2.

Arithmetic Operations for Fixed-Point Data

The general equation for a binary arithmetic operation between fixed-point operands is

$$c = a \text{ <op> } b$$

where a and b are fixed-point numbers and <op> refers to addition, subtraction, multiplication, or division. The result of the operation is a fixed-point number c of the form

$$V_c \approx S_c Q_c + B_c.$$

The fixed-point type for c determines the slope S_c , the bias B_c , and the number of bits used to store the quantized integer Q_c . For each arithmetic operation, this table lists the value of the quantized integer Q_c in terms of the values of the operands (a and b) and the fixed-point type for c .

Operation		Slope and Bias Scaling	Binary-Point Scaling
Addition	$c = a+b$	$Q_c = \text{round}((S_a/S_c)Q_a + (S_b/S_c)Q_b + (B_a + B_b - B_c)/S_c)$	$Q_c = \text{round}((S_a/S_c)Q_a + (S_b/S_c)Q_b)$
Subtraction	$c = a-b$	$Q_c = \text{round}((S_a/S_c)Q_a - (S_b/S_c)Q_b - (B_a - B_b - B_c)/S_c)$	$Q_c = \text{round}((S_a/S_c)Q_a - (S_b/S_c)Q_b)$
Multiplication	$c = a*b$	$Q_c = \text{round}((S_a S_b/S_c)Q_a Q_b + (B_a S_b/S_c)Q_a + (B_b S_a/S_c)Q_b + (B_a B_b - B_c)/S_c)$	$Q_c = \text{round}((S_a S_b/S_c)Q_a Q_b)$
Division	$c = a/b$	$Q_c = \text{round}((S_a Q_a + B_a)/(S_c(S_b Q_b + B_b)) - (B_c/S_c))$	$Q_c = \text{round}((S_a/(S_b S_c))Q_a/Q_b)$

To simplify these expressions and avoid computationally expensive operations, use binary-point scaling to encode all your fixed-point data. With this setting, the slope is an integer power of two and the bias is zero. Then, all fixed-point operations consist of integer arithmetic and bit shifts on the quantized integers.

Note The result of an arithmetic operation depends on the rounding method that computes the value of the quantized integer Q_c . For more information, see “Conversion Operations” on page 23-3.

Relational Operations for Fixed-Point Data

You can use relational operations to compare fixed-point data. Comparing fixed-point values of different types can yield unexpected results because each operand is converted to a common type for comparison. Because of rounding or overflow errors during the conversion, some values that appear to be equal are not equal as fixed-point numbers.

For example, suppose that a and b represent the real-world value $V = 2.2$ in two different fixed-point encoding schemes:

- a is a fixed-point number with slope $S_a = 0.3$ and bias $B_a = 0.1$. The quantized integer for a is:

$$Q_a = (V - B_a)/S_a = (2.2 - 0.1)/0.3 = 7.$$

- **b** is a fixed-point number with slope $S_b = 0.7$ and bias $B_b = 0.1$. The quantized integer for **b** is:
 $Q_b = (V - B_b)/S_b = (2.2 - 0.1)/0.7 = 3.$

To compare these values, the chart first converts them to a common fixed-point type with slope $S_{\text{comp}} = 1.06811 \cdot 10^{-5} \approx S_a/28087 \approx S_b \cdot 2^{-16}$ and bias $B_{\text{comp}} = 0.1$. (In this case, the slope S_{comp} arises from the approximate value of $S_a/S_b = 0.3/0.7 \approx 28087 \cdot 2^{-16}$.) In this common encoding scheme, **a** and **b** correspond to these quantized integers:

$$Q_{a'} = S_a Q_a / S_{\text{comp}} = Q_a (S_a / S_{\text{comp}}) \approx 7 \square 28087 = 196609$$

$$Q_{b'} = S_b Q_b / S_{\text{comp}} = Q_b (S_b / S_{\text{comp}}) \approx 3 \square 2^{16} = 196608.$$

After the conversion, the quantized integers are different. Although **a** and **b** represent the same real-world value, they are not equal as fixed-point numbers.

Note In charts that use C as the action language, comparisons of fixed-point operands with mismatched biases are not supported.

Logical Operations for Fixed-Point Data

In a logical operation, a fixed-point operand **a** is interpreted as `false` if it corresponds to the real-world value for zero in the fixed-point type of **a**. Otherwise, **a** is interpreted as `true`.

- In charts that use MATLAB as the action language, using **a** in a logical operation is equivalent to the expression `a ~= cast(0, 'like', a)`.
- In charts that use C as the action language, using **a** in a logical operation is equivalent to the expression `a != 0c`, where `0c` is a fixed-point context-sensitive constant. See “Fixed-Point Context-Sensitive Constants” on page 23-4.

For example, suppose that **a** is a fixed-point number with a slope of $S_a = 0.25$ and a bias of $B_a = 5.1$. Using **a** in a logical operation is equivalent to testing whether the quantized integer Q_a satisfies the condition

$$Q_a = \text{round}((0 - B_a)/S_a) = \text{round}(-5.1 / 0.25) = \text{round}(-20.4) = -20.$$

Therefore, **a** is equivalent to `false` when its real-world approximation is

$$V_a \approx S_a Q_a + B_a = 0.25 \square (-20) + 5.1 = 0.1.$$

Promotion Rules for Fixed-Point Operations

The rules for selecting the numeric type used for the result of an operation on fixed-point numbers are called *fixed-point promotion rules*. These rules help to maintain computational efficiency and usability.

The fixed-point promotion rules determine a result type for an operation $c = a \langle op \rangle b$ by selecting the slope S_c , the bias B_c , and the number of bits w_c used to store the quantized integer Q_c . These parameters depend on the fixed-point types of the operands **a** and **b**, the operation $\langle op \rangle$ to be performed, and the action language property for the chart.

- In a chart that uses MATLAB as the action language, you control the fixed-point promotion rules through the fixed-point properties for the chart. See “Fixed-Point Properties” on page 25-6.
- If you set the **MATLAB Chart `fimath`** property to `Same as MATLAB`, then arithmetic operations follow the default fixed-point promotion rules for MATLAB. See “Perform Fixed-Point Arithmetic” (Fixed-Point Designer).

- If you specify a chart `fimath` object with `SumMode` and `ProductMode` set to `SpecifyPrecision`, then you can define the word length, slope, and bias for all sums and products explicitly. See “`fimath` Object Properties” (Fixed-Point Designer).
- In a chart that uses C as the action language, the fixed-point promotion rules determine the type for an intermediate value of the result. This intermediate value is then cast to the type that you specify for `c`.

For all arithmetic operations, the default number of bits w_c used to store the quantized integer is the larger value between:

- The maximum number of bits in the operand types (w_a and w_b).
- The number of bits in the integer word size for the target machine (w_{int}).

To set the value of w_{int} , open the **Model Configuration Parameters** dialog box. On the **Hardware Implementation** pane, select Custom Processor from the **Device vendor** drop-down list and enter the target integer word size in the **int** field. For more information, see “Hardware Implementation Pane” (Simulink).

You can avoid overflow and improve the precision in your floating-point operations by using the special assignment operation of the form `c := a <op> b`. The special assignment operation does not follow the fixed-point promotion rules. Instead, the chart determines the result of the operation by using the type that you specify for `c`. See “Override Fixed-Point Promotion in C Charts” on page 23-15.

Addition and Subtraction

By default, charts that use MATLAB as the action language support addition and subtraction only on fixed-point data defined through binary-point scaling. If either operand is a signed fixed-point number, then the result is also signed. The choice of word length accommodates the integer and fraction parts of each operand in addition to a possible carry bit. The fraction length of the result is equal to the fraction length of the most precise operand. To perform addition and subtraction on fixed-point data defined by using either a slope that is not an integer power of two or a nonzero bias, specify a chart `fimath` object with `SumMode` set to `SpecifyPrecision`.

Charts that use C as the action language support addition and subtraction for operands of all fixed-point data types. The result is a signed fixed-point number only if both operands are signed. Mixing signed and unsigned operands can yield unexpected results and is not recommended. The slope of the result is equal to the slope of the least precise operand. To simplify calculations and yield efficient code, the biases of the two inputs are added for an addition operation and subtracted for a subtraction operation.

	a	b	MATLAB as the Action Language	C as the Action Language
Sign	s_a	s_b	$s_c = s_a \mid s_b$	$s_c = s_a \ \&\& \ s_b$
Word length	w_a	w_b	$w_c = \max(w_a - f_a, w_b - f_b) + \max(f_a, f_b) + 1$	$w_c = \max(w_a, w_b, w_{int})$
Fraction length	f_a	f_b	$f_c = \max(f_a, f_b)$	$f_c = \min(f_a, f_b)$

	a	b	MATLAB as the Action Language	C as the Action Language
Slope	S_a (2^{-f_a} if using binary-point scaling)	S_b (2^{-f_b} if using binary-point scaling)	$S_c = \min(S_a, S_b)$	$S_c = \max(S_a, S_b)$
Bias	B_a (0 if using binary-point scaling)	B_b (0 if using binary-point scaling)	$B_c = 0$	$B_c = B_a + B_b$ for addition or $B_c = B_a - B_b$ for subtraction

Multiplication

By default, charts that use MATLAB as the action language support multiplication only on fixed-point data defined through binary-point scaling. If either operand is a signed fixed-point number, then the result is also signed. A full precision product requires a word length equal to the sum of the word lengths of the operands. The fraction length of a product is the sum of the fraction lengths of the operands. To perform multiplication on fixed-point data defined by using either a slope that is not an integer power of two or a nonzero bias, specify a chart `fimath` object with `ProductMode` set to `SpecifyPrecision`.

Charts that use C as the action language support multiplication only on fixed-point data operands defined by nonzero biases. The result is a signed fixed-point number only if both operands are signed. Mixing signed and unsigned operands can yield unexpected results and is not recommended. The slope of a product is the product of the slopes of the operands.

	a	b	MATLAB as the Action Language	C as the Action Language
Sign	s_a	s_b	$s_c = s_a \&\& s_b$	$s_c = s_a \&\& s_b$
Word length	w_a	w_b	$w_c = w_a + w_b$	$w_c = \max(w_a, w_b, w_{int})$
Fraction length	f_a	f_b	$f_c = f_a + f_b$	$f_c = f_a + f_b$
Slope	S_a (2^{-f_a} if using binary-point scaling)	S_b (2^{-f_b} if using binary-point scaling)	$S_c = S_a S_b$	$S_c = S_a S_b$
Bias	$B_a = 0$	$B_b = 0$	$B_c = 0$	$B_c = 0$

Division

Charts that use MATLAB as the action language support division only on fixed-point data defined through binary-point scaling. If either operand is a signed fixed-point number, then the result is also signed. A full precision quotient requires a word length equal to the maximum number of bits in the operands. The fraction length of a quotient is the difference of the fraction lengths of the operands.

Charts that use C as the action language support division for fixed-point data operands defined by nonzero biases. The result is a signed fixed-point number only if both operands are signed. Mixing signed and unsigned operands can yield unexpected results and is not recommended. The slope of a quotient is the quotient of the slopes of the operands.

	a	b	MATLAB as the Action Language	C as the Action Language
Sign	s_a	s_b	$s_c = s_a \mid s_b$	$s_c = s_a \&\& s_b$
Word length	w_a	w_b	$w_c = \max(w_a, w_b)$	$w_c = \max(w_a, w_b, w_{int})$
Fraction length	f_a	f_b	$f_c = f_a - f_b$	$f_c = f_a - f_b$
Slope	S_a (2^{f_a} if using binary-point scaling)	S_b (2^{f_b} if using binary-point scaling)	$S_c = S_a/S_b$	$S_c = S_a/S_b$
Bias	$B_a = 0$	$B_b = 0$	$B_c = 0$	$B_c = 0$

Unary Minus

The only unary operation that requires a promotion of its result type is the unary minus operation $c = -a$. Taking the negative of an unsigned fixed-point number can yield unexpected results and is not recommended. The word size of the result depends on the action language property of the chart. The slope of the result is equal to the slope of the operand. The bias of the result type is the negative of the bias of the operand.

	a	MATLAB as the Action Language	C as the Action Language
Sign	s_a	$s_c = s_a$	$s_c = s_a$
Word length	w_a	$w_c = w_a$	$w_c = \max(w_a, w_{int})$
Fraction length	f_a	$f_c = f_a$	$f_c = f_a$
Slope	S_a (2^{f_a} if using binary-point scaling)	$S_c = S_a$	$S_c = S_a$
Bias	B_a (0 if using binary-point scaling)	$B_c = -B_a$	$B_c = -B_a$

Arithmetic with Mixed Numeric Types

This table summarizes the fixed-point promotion rules for a binary operation between a fixed-point number and an operand of a different numeric type.

Numeric Type of Second Operand	MATLAB as the Action Language	C as the Action Language
Floating-point numbers: <ul style="list-style-type: none"> • single • double 	Before performing the operation, the chart casts the floating-point operand to a fixed-point number. The type used for the cast depends on the operation: <ul style="list-style-type: none"> • Addition and subtraction operations use the same type as the fixed-point operand. • Multiplication operations use the same word length and signedness as the fixed-point operand, and the best precision fraction length for a fixed-point result. The result of the operation is a fixed-point number.	Before performing the operation, the chart casts the fixed-point operand to a floating-point number. The casting operation uses the same type (single or double) as the floating-point operand. The result of the operation is a floating-point number.
Integers: <ul style="list-style-type: none"> • int64 • int32 • int16 • int8 • uint64 • uint32 • uint16 • uint8 	The integer operand is treated as a fixed-point number of the same word length and signedness with slope $S = 1$ and bias $B = 0$. The result of the operation is a fixed-point number.	The integer operand is treated as a fixed-point number of the same word length and signedness with slope $S = 1$ and bias $B = 0$. The result of the operation is a fixed-point number.

See Also

More About

- “Fixed-Point Data in Stateflow Charts” on page 23-2
- “Supported Operations for Fixed-Point Data” on page 23-12
- “Build a Low-Pass Filter by Using Fixed-Point Data” on page 23-8

Complex Data

- “Complex Data in Stateflow Charts” on page 24-2
- “Supported Operations for Complex Data” on page 24-4
- “Rules for Using Complex Data in C Charts” on page 24-7
- “Best Practices for Using Complex Data in C Charts” on page 24-9

Complex Data in Stateflow Charts

Complex data is data whose value is a complex number. For example, in a Stateflow chart in Simulink model, an input signal with the value $3 + 5i$ is complex. See “Complex Signals” (Simulink).

Define Complex Data

- 1 Add a data object to your chart, as described in “Add Stateflow Data” on page 9-2.
- 2 Set the **Complexity** property for the data object to `On`. For more information, see “Complexity” on page 9-7.
- 3 Specify the name, scope, size, base type, and other properties for the data object, as described in “Set Data Properties” on page 9-5.
 - Complex data does not support the scope `Constant`.
 - Complex data does not support the base types `ml`, `struct`, and `boolean`.

When to Use Complex Data

Use complex data when you model applications in communication systems and digital signal processing. For example, you can use this design pattern to model a frame synchronization algorithm in a communication system:

- 1 Use Simulink blocks (such as filters) to process complex signals.
- 2 Use charts to implement mode logic for frame synchronization.
- 3 Let the charts access complex input and output data so that nested MATLAB functions can drive the mode logic.

For an example of modeling a frame synchronization algorithm, see “Detect Valid Transmission Data by Using Frame Synchronization”.

Note Continuous-time variables of complex type are *not* supported. For more information, see “Store Continuous State Information in Local Variables” on page 22-7.

Where You Can Use Complex Data

You can define complex data at these levels of the Stateflow hierarchy:

- Charts
- Subcharts
- States
- Functions

How You Can Use Complex Data

You can use complex data to define:

- Complex vectors

- Complex matrices

You can also use complex data as arguments for:

- State actions
- Transition actions
- MATLAB functions (see “Reuse MATLAB Code by Defining MATLAB Functions” on page 29-2)
- Truth table functions (see “Use Truth Tables to Model Combinatorial Logic” on page 28-2)
- Graphical functions (see “Reuse Logic Patterns by Defining Graphical Functions” on page 8-13)
- Change detection operators (see “Detect Changes in Data Values” on page 13-56)

Note Exported functions do not support complex data as arguments.



See Also

More About

- “Supported Operations for Complex Data” on page 24-4
- “Rules for Using Complex Data in C Charts” on page 24-7
- “Best Practices for Using Complex Data in C Charts” on page 24-9

Supported Operations for Complex Data

Stateflow charts in Simulink models have an action language property that defines the syntax that you use to compute with complex data. The action language properties are:

-  MATLAB as the action language.
-  C as the action language.

For more information, see “Differences Between MATLAB and C as Action Language Syntax” on page 14-5.

Notation for Complex Data

In charts that use MATLAB as the action language, you can define complex data by using complex number notation $a + bi$, where a and b are real numbers. For example, this statement assigns a value of $3+4i$ to x :

```
x = 3 + 4i;
```

Alternatively, you can define complex data by using the `complex` operator:

```
complex(<real_part>,<imag_part>)
```

`<real_part>` and `<imag_part>` are arguments that define the real and imaginary parts of the complex number, respectively. The two arguments must be real values or expressions that evaluate to real values. As in the preceding example, this statement assigns a value of $3+4i$ to x :

```
x = complex(3,4);
```

Charts that use C as the action language do not support complex number notation $a + bi$. To define a complex number based on two real values, use the `complex` operator.

Binary Operations

This table summarizes the interpretation of all binary operations on complex operands according to their order of precedence (1 = highest, 3 = lowest). Binary operations are left associative so that, in any expression, operators with the same precedence are evaluated from left to right.

Operation	Precedence	MATLAB as the Action Language	C as the Action Language
$a * b$	1	Multiplication.	Multiplication.
a / b	1	Division.	Not supported. Use the <code>\</code> operation in a MATLAB function. See “Perform Complex Division with a MATLAB Function” on page 24-10.
$a + b$	2	Addition.	Addition.
$a - b$	2	Subtraction.	Subtraction.
$a == b$	3	Comparison, equal to.	Comparison, equal to.

Operation	Precedence	MATLAB as the Action Language	C as the Action Language
$a \sim= b$	3	Comparison, not equal to.	Comparison, not equal to.
$a \neq b$	3	Not supported. Use the operation $a \sim= b$.	Comparison, not equal to.
$a <> b$	3	Not supported. Use the operation $a \sim= b$.	Comparison, not equal to.

Unary Operations and Actions

This table summarizes the interpretation of all unary operations and actions on complex data. Unary operations:

- Have higher precedence than the binary operators.
- Are right associative so that, in any expression, they are evaluated from right to left.

Operation	MATLAB as the Action Language	C as the Action Language
$-a$	Negative.	Negative.
$a++$	Not supported. Use the expression $a = a + 1$.	Increment. Equivalent to $a = a + 1$.
$a--$	Not supported. Use the expression $a = a - 1$.	Decrement. Equivalent to $a = a - 1$.

Assignment Operations

This table summarizes the interpretation of assignment operations in Stateflow charts.

Operation	MATLAB as the Action Language	C as the Action Language
$a = b$	Simple assignment.	Simple assignment.
$a += b$	Not supported. Use the expression $a = a + b$.	Equivalent to $a = a + b$.
$a -= b$	Not supported. Use the expression $a = a - b$.	Equivalent to $a = a - b$.
$a *= b$	Not supported. Use the expression $a = a * b$.	Equivalent to $a = a * b$.

Access Real and Imaginary Parts of a Complex Number

To access the real and imaginary parts of a complex number, use the `real` and `imag` operators.

real Operator

The `real` operator returns the value of the real part of a complex number:

```
real(<complex_expr>)
```

`<complex_expr>` is an expression that evaluates to a complex number. For example, if `frame(200)` evaluates to the complex number $8.23 + 4.56i$, this expression returns a value of `8.2300`:

```
real(frame(200))
```

imag Operator

The `imag` operator returns the value of the imaginary part of a complex number:

```
imag(<complex_expr>)
```

`<complex_expr>` is an expression that evaluates to a complex number. For example, if `frame(200)` evaluates to the complex number $8.23 + 4.56i$, this expression returns a value of 4.5600 :

```
imag(frame(200))
```

See Also

`complex` | `i` | `imag` | `real`

More About

- “Complex Data in Stateflow Charts” on page 24-2
- “Rules for Using Complex Data in C Charts” on page 24-7
- “Best Practices for Using Complex Data in C Charts” on page 24-9

Rules for Using Complex Data in C Charts

Complex data is data whose value is a complex number. For example, in a Stateflow chart in Simulink model, an input signal with the value $3 + 5i$ is complex. See “Complex Data in Stateflow Charts” on page 24-2.

These rules apply when you use complex data in Stateflow charts that use C as the action language.

Do not use complex number notation in actions

C charts do not support complex number notation ($a + bi$), where a and b are real numbers. Therefore, you cannot use complex number notation in state actions, transition conditions and actions, or any statements in C charts.

To define a complex number, use the `complex` operator as described in “Notation for Complex Data” on page 24-4.

Do not perform math function operations on complex data in C charts

Math operations such as `sin`, `cos`, `min`, `max`, and `abs` do not work with complex data in C charts. However, you can use MATLAB functions for these operations.

For more information, see “Perform Math Function Operations with a MATLAB Function” on page 24-9.

Mix complex and real operands only for addition, subtraction, and multiplication

If you mix operands for any other math operations in C charts, an error appears when you try to simulate your model.

To mix complex and real operands for division, you can use a MATLAB function as described in “Perform Complex Division with a MATLAB Function” on page 24-10.

Tip Another way to mix operands for division is to use the `complex`, `real`, and `imag` operators in C charts.

Suppose that you want to calculate $y = x1/x2$, where $x1$ is complex and $x2$ is real. You can rewrite this calculation as:

```
y = complex(real(x1)/x2, imag(x1)/x2)
```

For more information, see “Access Real and Imaginary Parts of a Complex Number” on page 24-5.

Do not define complex data with constant scope

If you define complex data with Constant scope, an error appears when you try to simulate your model.

Do not define complex data with `ml`, `struct`, or `boolean` base type

If you define complex data with `ml`, `struct`, or `boolean` base type, an error appears when you try to simulate your model.

Use only real values to set initial values of complex data

When you define the initial value for data that is complex, use only a real value. See “Additional Properties” on page 9-15 for instructions on setting an initial value in the Data properties dialog box.

Do not enter minimum or maximum values for complex data

In the Data properties dialog box, do not enter any values in the **Minimum** or **Maximum** field when you define complex data. If you enter a value in either field, an error message appears when you try to simulate your model.

Assign complex values only to data of complex type

If you assign complex values to real data types, an error appears when you try to simulate your model.

Note You can assign both real and complex values to complex data types.

Do not pass real values to function inputs of complex type

This restriction applies to the following types of chart functions:

- Graphical functions
- Truth table functions
- MATLAB functions
- Simulink functions

If your C chart passes real values to function inputs of complex type, an error appears when you try to simulate your model.

Do not use complex data with temporal logic operators

You cannot use complex data as an argument for temporal logic operators, because you cannot define time as a complex number.

See Also**More About**

- “Complex Data in Stateflow Charts” on page 24-2
- “Supported Operations for Complex Data” on page 24-4
- “Best Practices for Using Complex Data in C Charts” on page 24-9

Best Practices for Using Complex Data in C Charts

Complex data is data whose value is a complex number. For example, in a Stateflow chart in Simulink model, an input signal with the value $3 + 5i$ is complex. See “Complex Data in Stateflow Charts” on page 24-2.

When you use complex data in Stateflow charts that use C as the action language, follow these best practices.

Perform Math Function Operations with a MATLAB Function

Math functions such as `sin`, `cos`, `min`, `max`, and `abs` do not work with complex data in C charts. However, you can use a MATLAB function in your chart to perform math function operations on complex data.

A Simple Example

In the following chart, a MATLAB function calculates the absolute value of a complex number:

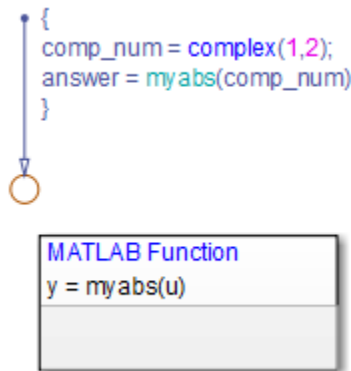

The value of `comp_num` is $1+2i$. Calculating the absolute value gives an answer of 2.2361.

How to Calculate Absolute Value

Suppose that you want to find the absolute value of a complex number. Follow these steps:

- 1 Add a MATLAB function to your chart with this signature:

```
y = myabs(u)
```

- 2 Double-click the function box to open the editor.
- 3 In the editor, enter the code below:

```

function y = myabs(u)
%#codegen
y = abs(u);

```

The function `myabs` takes a complex input `u` and returns the absolute value as an output `y`.

- 4 Configure the input argument `u` to accept complex values.
 - a Open the Model Explorer.

- b** In the **Model Hierarchy** pane of the Model Explorer, navigate to the MATLAB function `myabs`.
- c** In the **Contents** pane of the Model Explorer, right-click the input argument `u` and select **Properties** from the context menu.
- d** In the Data properties dialog box, select `On` in the **Complexity** field and click **OK**.

You cannot pass real values to function inputs of complex type. For details, see “Rules for Using Complex Data in C Charts” on page 24-7.

Perform Complex Division with a MATLAB Function

Division with complex operands is not available as a binary or assignment operation in C charts. However, you can use a MATLAB function in your chart to perform division on complex data.

A Simple Example

In the following chart, a MATLAB function performs division on two complex operands:

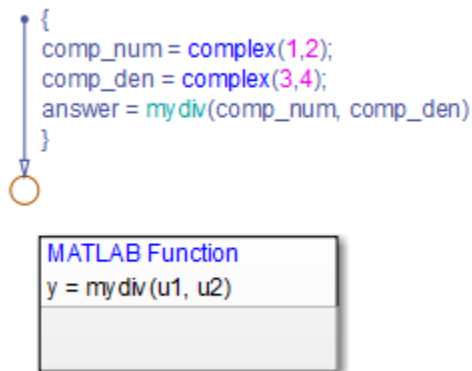

The values of `comp_num` and `comp_den` are $1+2i$ and $3+4i$, respectively. Dividing these values gives an answer of $0.44+0.08i$.

How to Perform Complex Division

To divide two complex numbers:

- 1** Add a MATLAB function to your chart with this function signature:

```
y = mydiv(u1, u2)
```

- 2** Double-click the function box to open the editor.
- 3** In the editor, enter the code below:

```
function y = mydiv(u1, u2)
%#codegen
y = u1 / u2;
```

The function `mydiv` takes two complex inputs, `u1` and `u2`, and returns the complex quotient of the two numbers as an output `y`.

- 4** Configure the input and output arguments to accept complex values.

- a** Open the Model Explorer.
- b** In the **Model Hierarchy** pane of the Model Explorer, navigate to the MATLAB function `mydiv`.
- c** For each input and output argument, follow these steps:
 - i** In the **Contents** pane of the Model Explorer, right-click the argument and select **Properties** from the context menu.
 - ii** In the Data properties dialog box, select **On** in the **Complexity** field and click **OK**.

You cannot pass real values to function inputs of complex type. For details, see “Rules for Using Complex Data in C Charts” on page 24-7.

See Also

More About

- “Complex Data in Stateflow Charts” on page 24-2
- “Supported Operations for Complex Data” on page 24-4
- “Rules for Using Complex Data in C Charts” on page 24-7

Define Interfaces to Simulink Models and the MATLAB Workspace

- “Specify Properties for Stateflow Charts” on page 25-2
- “Implement Interfaces to Simulink Models” on page 25-9
- “Reuse Charts in Models with Chart Libraries” on page 25-12
- “Create a Mask to Share Parameters with Simulink” on page 25-14
- “Specify Units for Stateflow Data” on page 25-17

Specify Properties for Stateflow Charts

Chart properties enable you to specify how your Stateflow chart interfaces with a Simulink model. You can specify chart properties in the Property Inspector, the Model Explorer, or the Chart properties dialog box.

- Property Inspector
 - 1 To open the Property Inspector, in the **Modeling** tab, select **Property Inspector**.
 - 2 Click in the chart.
 - 3 In the Property Inspector, edit the chart properties.
- Model Explorer
 - 1 To open the Model Explorer, in the **Modeling** tab, select **Model Explorer**.
 - 2 In the **Model Hierarchy** pane, select the chart.
 - 3 In the **Chart** pane, edit the chart properties.
- Chart properties dialog box
 - 1 Right-click in the chart.
 - 2 Select **Properties**.
 - 3 Edit the chart properties.

Stateflow Chart Properties

You can set the following chart properties in:

- The main and **Advanced** sections of the Property Inspector.
- The **General** tab of the Model Explorer or the Chart properties dialog box.

Name

Name of the chart (read-only). When you click the chart name hyperlink, the chart opens in the Stateflow Editor.

Machine

Name of the Simulink subsystem (read-only). When you click the machine name hyperlink, the Machine properties dialog box opens. This property is not available in the Property Inspector.

Action Language

Action language that defines the syntax for state and transition actions in the chart. Options include:

- MATLAB
- C

The default value is MATLAB. For more information, see “Differences Between MATLAB and C as Action Language Syntax” on page 14-5.

State Machine Type

Type of state machine semantics to implement. Options include:

- Classic
- Mealy
- Moore

Classic charts provide the full set of Stateflow semantics. Mealy and Moore charts use a subset of these semantics. The default value is **Classic**. For more information, see “Overview of Mealy and Moore Machines” on page 7-2.

Update Method

Method by which a simulation updates or wakes up a chart in a Simulink model.

Setting	Description
Inherited	<p>Input from the Simulink model determines when the chart wakes up during a simulation (default).</p> <p>If you define input events for the chart, the Stateflow chart is explicitly triggered by a signal on its trigger port originating from a connected Simulink block. You can set this trigger input event to occur in response to a Simulink signal. The Simulink signal can be Rising, Falling, or Either (rising and falling), or in response to a Function Call. For more information, see “Activate a Stateflow Chart by Sending Input Events” on page 11-7.</p> <p>If you do not define input events, the Stateflow chart implicitly inherits triggers from the Stateflow model. These implicit events are the discrete or continuous sample times of the Stateflow signals providing inputs to the chart. If you define data inputs, the chart awakens at the rate of the fastest data input. If you do not define any data input for the chart, the chart wakes up as defined by the execution behavior of its parent subsystem.</p>
Discrete	<p>The Simulink model generates an implicit event at regular time intervals to awaken the Stateflow chart at the rate that you specify in the Sample Time chart property. Other blocks in the Simulink model can have different sample times.</p>
Continuous	<p>The Stateflow chart updates its state during major time steps only, although it computes outputs and local continuous variables during major and minor time steps. The chart can register zero crossings, which allows Simulink models to sample Stateflow charts whenever state changes occur. The Stateflow chart computes derivatives for local continuous variables. For more information, see “Continuous-Time Modeling in Stateflow” on page 22-2.</p>

Sample Time

The time interval at which the Stateflow chart wakes up during simulation. The sample time can be any nonzero number. The sample time is in the same units as the Simulink simulation time. Other blocks in the Simulink model can have different sample times. This option is available only when you set the chart property **Update method** to **Discrete**.

Enable Zero-Crossing Detection

Specifies that zero-crossing detection is enabled (default). This option is available only when you set the chart property **Update method** to Continuous. See “Disable Zero-Crossing Detection” on page 22-4.

Enable C-Bit Operations

Specifies that the operators `&`, `^`, `|`, and `~` perform bitwise operations in action statements (default). If you clear this check box:

- `&`, `|`, and `~` perform logical operations.
- `^` performs the power operation.

This option is available only in charts that use C as the action language. For more information, see “Supported Operations for Chart Data” on page 13-13.

User-Specified State/Transition Execution Order

Specifies that the chart uses explicit ordering of parallel states and transitions (default). You determine the order in which the chart executes parallel states and tests transitions originating from a source. This option is available only in charts that use C as the action language. For more information, see “Execution Order for Parallel States” on page 3-58 and “Evaluate Transitions” on page 3-37.

Export Chart Level Functions

Extends the scope of functions defined at the root level of the chart to other parts of the model. This option enables Simulink Caller blocks to call Stateflow functions in the local hierarchy by using qualified notation *chartName.functionName*. For more information, see “Export Stateflow Functions for Reuse” on page 8-17.

Treat Exported Functions as Globally Visible

Enables Stateflow and Simulink Caller blocks throughout the model to call functions exported from Stateflow without using qualified notation. This option is available only when you select the chart property **Export Chart Level Functions**. For more information, see “Export Stateflow Functions for Reuse” on page 8-17.

Use Strong Data Typing with Simulink I/O

Enables charts to interface directly with signals from Simulink models (default). The chart accepts only input signals whose data type matches the type of the corresponding Stateflow data object. Otherwise, a type mismatch error occurs. This option is available only in charts that use C as the action language. For more information, see “Strong Data Typing with Simulink Inputs and Outputs” on page 9-31.

Note The **Use Strong Data Typing with Simulink I/O** chart property is provided for backward compatibility. Clearing this check box can produce unpredictable results and is not recommended.

Execute (Enter) Chart at Initialization

Specifies that the chart initializes its state configuration at time 0 instead of at the first occurrence of an input event. For more information, see “Execution of a Chart at Initialization” on page 3-21.

Initialize Outputs Every Time Chart Wakes Up

Specifies that the chart resets its output values every time that the chart wakes up, not only at time 0. Output values are reset whenever a chart is triggered by function call, edge trigger, or clock tick. If you set an initial value for an output data object, the output resets to that value. Otherwise, the output resets to zero. Select this option to:

- Ensure that all outputs are defined in every chart execution.
- Prevent latching of outputs (carrying over values of outputs computed in previous executions).
- Provide all chart outputs with a meaningful initial value.

For more information, see “Initial Value” on page 9-8.

Enable Super Step Semantics

Specifies that the chart can take multiple transitions in each time step until it reaches a stable state. This option is not available when you set the chart property **Update method** to Continuous. For more information, see “Super Step Semantics” on page 3-45.

Maximum Iterations in Each Super Step

Specifies the maximum number of transitions that the chart can take in each time step. The chart always takes one transition during a super step, so the value N that you specify represents the maximum number of *additional* transitions (for a total of $N+1$). This option is available only when you select the chart property **Enable Super Step Semantics**. For more information, see “Maximum Number of Iterations” on page 3-45.

Behavior After Too Many Iterations

Specifies how the chart behaves after it reaches the maximum number of transitions in a time step.

Setting	Description
Proceed	Chart execution continues to the next time step.
Throw Error	Simulation stops and an error message appears. This setting is valid only for simulation. In generated code, chart execution always proceeds.

This option is available only when you select the chart property **Enable Super Step Semantics**.

Support Variable-Size Arrays

Specifies that chart supports input and output data that varies in dimension during simulation. See “Declare Variable-Size Inputs and Outputs” on page 19-2.

Saturate on Integer Overflow

Specifies that integer overflows saturate in the generated code. See “Handle Integer Overflow for Chart Data” on page 9-36.

Generate preprocessor conditionals

Generates a preprocessor conditional in the generated code. See “Software Configurations Using Variant Transitions” on page 32-8.

States When Enabling

Specifies how states behave when function-call input events reenable the chart. Options include:

- Held
- Reset

See “Control States in Charts Enabled by Function-Call Input Events” on page 11-11.

Create Output for Monitoring

Specifies that the chart produces active state output. When you enable this option, you can select one of these activity types to output:

- Child activity
- Leaf state activity

See “Monitor State Activity Through Active State Data” on page 10-2.

Fixed-Point Properties

You can set fixed-point properties for the chart in:

- The **Fixed Point Properties** section of the Property Inspector.
- The **Fixed Point Properties** tab of the Model Explorer or the Chart properties dialog box.

Fixed-point properties are available only in charts that use MATLAB as the action language.

Treat These Inherited Simulink Signal Types as fi Objects

Specifies whether the chart treats inherited fixed-point and integer signals as Fixed-Point Designer™ **fi** objects.

Setting	Description
Fixed-point	The chart treats all fixed-point inputs as fi objects (default).
Fixed-point & Integer	The chart treats all fixed-point and integer inputs as fi objects.

MATLAB Chart fimath

Specifies default properties for the chart.

Setting	Description
Same as MATLAB	Use the same fimath properties as the current default fimath object in MATLAB.

Setting	Description
Specify Other	Use your own default <code>fimath</code> object. You can: <ul style="list-style-type: none"> • Construct a <code>fimath</code> object inside the edit box. • Create a <code>fimath</code> object in the MATLAB or model workspace and enter its variable name in the edit box.

For more information, see “`fimath` Properties Usage for Fixed-Point Arithmetic” (Fixed-Point Designer).

Additional Properties

You can set additional properties for the chart in:

- The **Info** tab of the Property Inspector.
- The **Documentation** tab of the Model Explorer or the Chart properties dialog box.

Description

Description of the chart. You can enter a brief description and comments.

Document Link

Link to online documentation for the chart. You can enter a web URL address or a MATLAB command that displays documentation in a suitable online format, such as an HTML file or text in the MATLAB Command Window. When you click the **Document link** hyperlink, Stateflow evaluates the link and displays the documentation.

Machine Properties

The Stateflow machine represents all of the Stateflow blocks in a model (including all charts, state transition tables, and truth tables). You can specify machine properties in the Machine properties dialog box.

- 1 Open the Model Explorer or the Chart properties dialog box for any chart in the model.
- 2 In the **Machine** chart property field, click the machine name link.
- 3 In the Machine properties dialog box, edit the properties for the Stateflow machine.

Simulink Model

Name of the Simulink model that defines this Stateflow machine (read-only). You change the model name when you save the model.

Creation Date

Date on which this Stateflow machine was created (read-only).

Creator

Name of the person who created this Stateflow machine.

Modified

Comment text for recording modifications to the Simulink model that defines this Stateflow machine.

Version

Comment text for recording the version of the Simulink model that defines this Stateflow machine.

Description

Description of the Stateflow machine. You can enter a brief description and comments.

Document Link

Link to online documentation for the Stateflow machine. You can enter a web URL address or a MATLAB command that displays documentation in a suitable online format, such as an HTML file or text in the MATLAB Command Window. When you click the **Document link** hyperlink, Stateflow evaluates the link and displays the documentation.

See Also**More About**

- “Differences Between MATLAB and C as Action Language Syntax” on page 14-5
- “Overview of Mealy and Moore Machines” on page 7-2
- “Continuous-Time Modeling in Stateflow” on page 22-2
- “Supported Operations for Chart Data” on page 13-13

Implement Interfaces to Simulink Models

In this section...

- “Define a Triggered Stateflow Block” on page 25-9
- “Define a Sampled Stateflow Block” on page 25-9
- “Define an Inherited Stateflow Block” on page 25-10
- “Define a Continuous Stateflow Block” on page 25-11
- “Define Function-Call Output Events” on page 25-11
- “Define Edge-Triggered Output Events” on page 25-11

Define a Triggered Stateflow Block

Essential conditions that define an edge-triggered Stateflow block are:

- The chart property **Update method** is **Discrete** or **Inherited**. See “Update Method” on page 25-3.
- The chart has an **Input** event defined and an edge-trigger type specified. See “Activate a Stateflow Chart by Sending Input Events” on page 11-7.

Triggered Stateflow Block Example

The following model shows an edge-triggered Stateflow block named Callee:

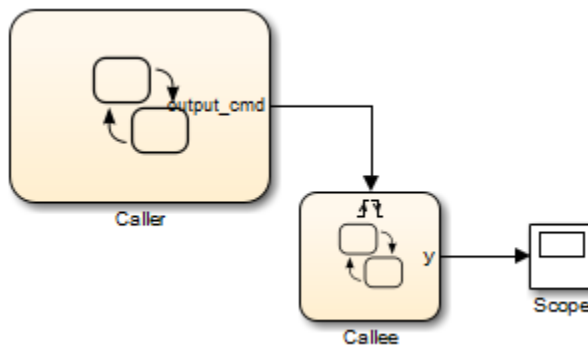

The **Input** event has an **Either** edge-trigger type. If you define more than one **Input** event, the Simulink model determines the sample times to be consistent with various rates of all the incoming signals. The outputs of a triggered Stateflow block are held after the execution of the block.

Define a Sampled Stateflow Block

There are two ways you can define a sampled Stateflow block.

- Set the chart property **Update method** to **Discrete** and enter a **Sample Time** value. See “Update Method” on page 25-3.
- In the Stateflow Editor, in the **Modeling** tab, under **Design Data**, select **Data Input**. See “Share Input and Output Data with Simulink” on page 9-19.

Simulink determines the chart sample time to be consistent with the rate of the incoming data signal.

The **Sample Time** you set in the Chart properties dialog box takes precedence over the sample time of any input data.

Sampled Stateflow Block Example

You specify a discrete sample rate to have Simulink trigger a Stateflow block that does use an explicit trigger port. You can specify a sample time for the chart in the Chart properties dialog box. Simulink then calls the Stateflow block at a defined, regular sample time.

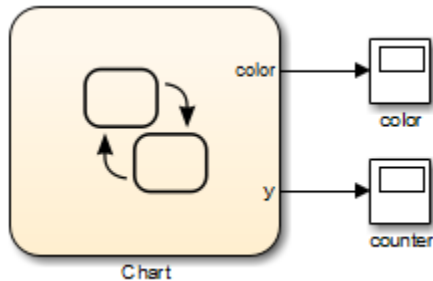

The outputs of a sampled Stateflow block are held after the execution of the block.

Define an Inherited Stateflow Block

Essential conditions that define an inherited trigger Stateflow block are:

- The chart property **Update method** is **Discrete** or **Inherited**. See “Update Method” on page 25-3.
- The chart has an **Input from Simulink** data object defined using the Stateflow Editor **Add** menu or the Model Explorer. See “Share Input and Output Data with Simulink” on page 9-19. Simulink determines the chart sample time to be consistent with the rate of the incoming data signal.

Inherited Stateflow Block Example

Simulink can trigger a Stateflow block that does not use an explicit trigger port or a specified discrete sample time. In this case, the Simulink calls the Stateflow block at a sample time determined by the model.

In this example, the chart contains two **Input from Simulink** data objects. Simulink determines the sample times to be consistent with the rates of both incoming signals.

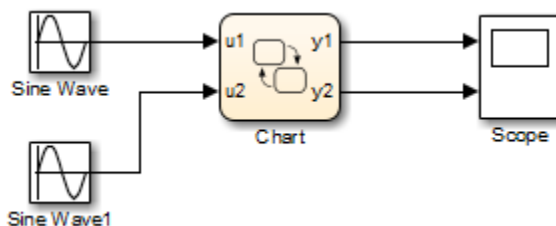

The outputs of an inherited trigger Stateflow block are held after the execution of the block.

Define a Continuous Stateflow Block

To define a continuous Stateflow block, set the chart **Update method** in the Chart properties dialog box to **Continuous**.

Define Function-Call Output Events

This topic shows you how to trigger a function-call subsystem in a Simulink model with a function-call output event in a Stateflow chart. The procedure assumes that you have a programmed function-call subsystem and a Stateflow block in the model. Use the following steps to connect the Stateflow block to the function-call subsystem and trigger it during simulation.

- 1 In the **Modeling** tab, select under **Design Data**, click **Event Output**.

The Event properties dialog box appears with a default name of event and a **Scope of Output** to Simulink.

- 2 Set **Trigger** to Function Call.
- 3 Name the event appropriately and click **OK** to close the dialog box.

An output port with the name of the event you add appears on the right side of the Stateflow block.

- 4 Connect the output port on the Stateflow block for the function-call output event to the input trigger port of the subsystem.

Avoid placing any other blocks in the connection lines between the Stateflow block and the function-call subsystem.

Note You cannot connect a function-call output event from a chart to a Demux block to trigger multiple subsystems.

- 5 To execute the function-call subsystem, include an event broadcast of the function-call output event in the actions of the chart.

For examples of using function-call output events, see “Activate a Simulink Block by Using Function Calls” on page 11-17.

Define Edge-Triggered Output Events

Simulink controls the execution of edge-triggered subsystems with output events. Essential conditions that define this use of triggered output events are:

- The chart has an **Output to Simulink** event with the trigger type set to **Either**. See “Activate a Simulink Block by Sending Output Events” on page 11-14.
- The Simulink block connected to the edge-triggered **Output** event has its own trigger type set to the equivalent edge trigger.

For examples of using edge-triggered output events, see “Activate a Simulink Block by Using Edge Triggers” on page 11-14.

Reuse Charts in Models with Chart Libraries

In Simulink, you can create your own block libraries as a way to reuse the functionality of blocks or subsystems in one or more models. Similarly, you can reuse a set of Stateflow algorithms by encapsulating the functionality in a chart library.

As with other Simulink block libraries, you can specialize each instance of chart library blocks in your model to use different data types, sample times, and other properties. Library instances that inherit the same properties can reuse generated code.

For more information about Simulink block libraries, see “Custom Libraries” (Simulink).

Create Specialized Chart Libraries for Large-Scale Modeling

- 1 Add Stateflow charts with polymorphic logic to a Simulink model.

Polymorphic logic is logic that can process data with different properties, such as type, size, and complexity.

- 2 Configure the charts to inherit the properties you want to specialize.

For a list, see “Customize Properties of Library Blocks” on page 25-12.

- 3 Optionally, customize your charts using masking.
- 4 Simulate and debug your charts.
- 5 In Simulink, create a library model. In the **Simulation** tab, select **New > Library**
- 6 Copy or drag the charts into a library model.

For an example using MATLAB Function blocks, see “Create Custom Block Libraries” (Simulink).

Customize Properties of Library Blocks

You can customize instances of Stateflow library blocks by allowing them to inherit any of the following properties from Simulink.

Property	Inherits by Default?	How to Specify Inheritance
Type	Yes	Set the data type property to Inherit: Same as Simulink .
Size	Yes	Set the data size property to -1 .
Complexity	Yes	Set the data complexity property to Inherited .
Limit range	No	Specify minimum and maximum values as Simulink parameters. For example, if minimum value = <code>aParam</code> and maximum value = <code>aParam + 3</code> , different instances of a Stateflow library block can resolve to different <code>aParam</code> parameters defined in their parent mask subsystems.

Property	Inherits by Default?	How to Specify Inheritance
Initial value	Depends on scope	For local data, temporary data, and outputs, specify initial values as Simulink parameters. Other data always inherits the initial value: <ul style="list-style-type: none"> Parameters inherit the initial value from the associated parameter in the parent mask subsystem. Inputs inherit the initial value from the Simulink input signal. Data store memory inherits the initial value from the Simulink data store to which it is bound.
Sampling mode (input)	Yes	Stateflow chart input ports always inherit sampling mode.
Data type override mode for fixed-point data	Yes	Different library instances inherit different data type override modes from their ancestors in the model hierarchy.
Sample time (block)	Yes	Set the block sample time property to -1 .

Limitations of Library Charts

Events parented by a library Stateflow machine are invalid. The parser flags such events as errors.

Create a Mask to Share Parameters with Simulink

Creating masks for Stateflow charts, state transition tables, and truth tables simplifies how you use and share blocks in a Simulink model. The mask encapsulates the block by hiding the underlying logic and creates a user interface for the block. You can customize the block by:

- Changing the appearance with meaningful icons and ports.
- Creating a user interface for parameters.
- Adding customized documentation.

You decide which parameters to change through the mask user interface. You can provide meaningful descriptions of these parameters. For example, in the model `sf_car`, the `shift_logic` chart has a mask through which you can adjust the parameter `TWAIT`. To open the Mask Parameters dialog box, double-click the Stateflow chart. This dialog box contains a parameter description "Delay before gear change (tick)" and a box to edit the value. This value is tied to the parameter `TWAIT` inside the mask. When you edit the value in this box, Stateflow assigns the new value to `TWAIT` during simulation.

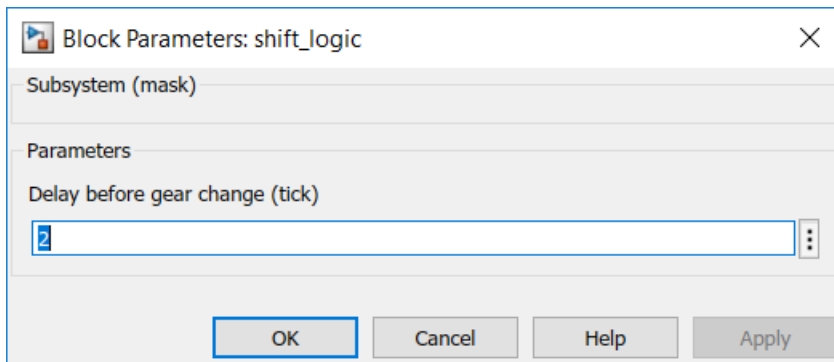

You can create other types of user interfaces for the mask parameters, such as check boxes, context menus, and option buttons.

You can create masks on Stateflow blocks accessible from the Simulink library: charts, state transition tables, and truth tables. You cannot mask atomic subcharts, states, or any other objects within a chart.

For more information, see "Create Block Masks" (Simulink).

Create a Mask for a Stateflow Chart

To create a mask for the Stateflow chart in the model `old_sf_car`:

- 1 Open the model `old_sf_car`.
- 2 In the Simulink Editor, select the chart `shift_logic`.
- 3 Open the Mask Editor. In the **State Chart** tab, click **Create Mask**.

Add an Icon to the Mask

To customize the appearance of the block icon, use drawing commands or load an image. For more information, see "Draw Mask Icon" (Simulink).

- 1 In the Mask Editor, select the **Icon & Ports** pane.
- 2 In the edit box under **Icon Drawing commands**, enter:

```
image('shift_logic.svg')
```

- 3 Click **Apply**.

Add Parameters to the Mask

When you create a mask for a Stateflow block, you can define a custom interface for the block parameters. You provide access to the block parameters by defining corresponding parameters with the same name in the Mask Editor. A user interface to these parameters is then provided through a Mask Parameters dialog box. The mask parameters appear as editable fields in the Mask Parameters dialog box. Stateflow applies these values to the corresponding block parameters during simulation.

For example, the chart `shift_logic` has a parameter `TWAIT`. To add `TWAIT` as a parameter to the mask:

- 1 In the Mask Editor, select the **Parameters & Dialog** pane.
- 2 Double-click the **Edit parameter** icon .
- 3 Next to **edit**, under **Prompt**, enter the prompt for the new mask parameter in the Mask Parameters dialog box:

```
Delay before gear change(tick)
```

- 4 Under **Name**, enter the name of the parameter in the mask:

```
TWAIT
```

- 5 Click **Apply**.
- 6 Click **OK**.

View the New Mask

After creating a mask, the new icon for the `shift_logic` chart appears in the Simulink canvas. If you double-click the icon, the Mask Parameters dialog box opens. This dialog box has the prompt for the parameter `TWAIT`. The value in the edit box is assigned to the parameter `TWAIT` during simulation.

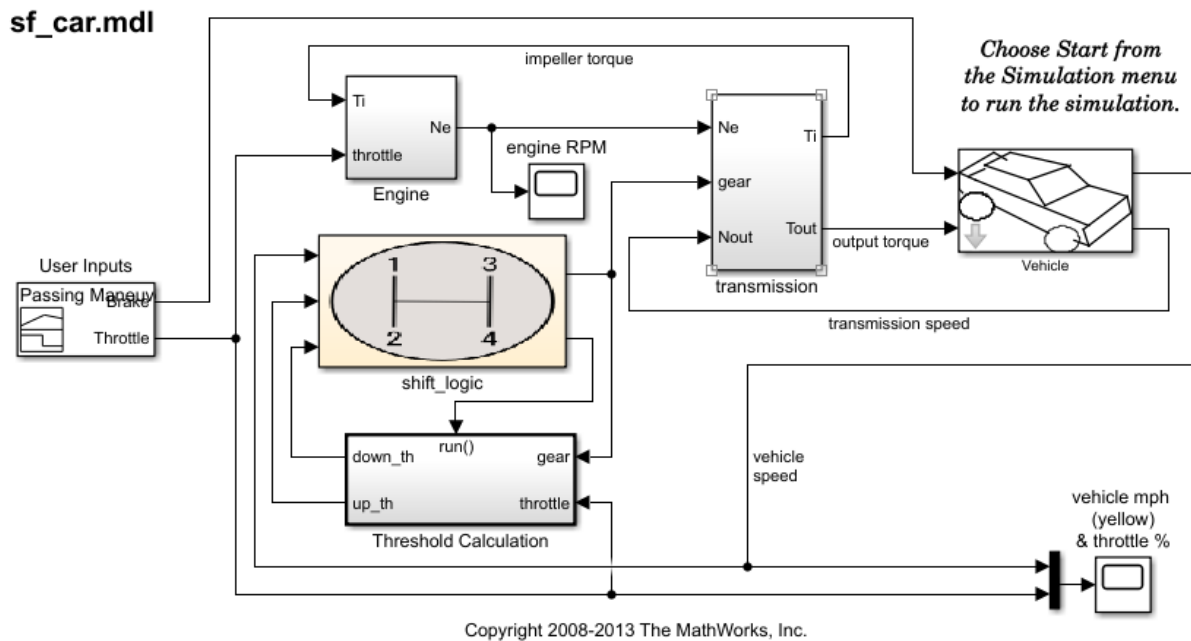

Look Under the Mask

You can view and edit the contents of a masked block by clicking the **Look inside mask** badge on the chart. The badge is a downward facing arrow in the lower-left corner of the chart. Alternatively, in the **State Chart** tab, click **Look Under Mask**. Looking under a mask does not unmask the block.

Edit the Mask

To edit a mask, in the **State Chart** tab, click **Edit Mask**. In the Mask Editor, you can modify the mask icon, change the parameters, or add documentation. To remove the mask, click **Unmask** in the lower corner of the Mask Editor. After you change a mask, click **Apply** to save the changes.

See Also

More About

- “Share Parameters with Simulink and the MATLAB Workspace” on page 9-21
- “Masking Fundamentals” (Simulink)
- “Mask Editor Overview” (Simulink)
- “Draw Mask Icon” (Simulink)

Specify Units for Stateflow Data

Units for Input and Output Data

Stateflow charts in Simulink models support the specification of physical units as properties for data inputs and outputs. Specify units by using the **Unit (e.g., m, m/s², N*m)** parameter for input or output data on charts, state transition tables, or truth tables. When you start typing in the field, this parameter provides matching suggestions for units that Simulink supports. By default, the property is set to inherit the unit from the Simulink signal on the corresponding input or output port. If you select the **Data must resolve to signal object** property for output data, you cannot specify units. In this case, output data is assigned the same unit type as the Simulink signal connected to the output port.

To display the units on the Simulink lines in the model, in the **Debug** tab, select **Information Overlays > Port Units**.

Consistency Checking

Stateflow checks the consistency of the signal line unit from Simulink with the unit setting for the corresponding input or output data in the Stateflow block. If the units do not match, Stateflow displays a warning during model update.

Units for Stateflow Limitations

The unit property settings do not affect the execution of the Stateflow block. Stateflow checks only consistency with the corresponding Simulink signal line connected to the input or output. It does not check consistency of assignments inside the Stateflow blocks. For example, Stateflow does not warn against an assignment of an input with unit set to `ft` to an output with unit set to `m`. Stateflow does not perform unit conversions.

See Also

More About

- “Unit Specification in Simulink Models” (Simulink)

Structures and Bus Signals in Stateflow Charts

- “Access Bus Signals Through Stateflow Structures” on page 26-2
- “Index and Assign Values to Stateflow Structures” on page 26-7
- “Integrate Custom Structures in Stateflow Charts” on page 26-10

Access Bus Signals Through Stateflow Structures

A Stateflow structure is a data type that you define from a `Simulink.Bus` object. Using Stateflow structures, you can bundle data of different size and type to create:

- Inputs and outputs that access Simulink bus signals from Stateflow charts, Truth Table blocks, and MATLAB Function blocks.
- Local data in Stateflow charts, truth tables, graphical functions, MATLAB functions, and boxes.
- Temporary data in Stateflow graphical functions, truth tables, and MATLAB functions.

For example, in the model `sf_bus_demo`, a Stateflow chart receives a bus input signal by using the structure `inbus` and outputs a bus signal from the structure `outbus`. The input signal comes from the Simulink Bus Creator block `COUNTERBUSCreator`, which bundles signals from two other Bus Creator blocks. The output structure `outbus` connects to a Simulink Bus Selector block. Both `inbus` and `outbus` derive their type from the `Simulink.Bus` object `COUNTERBUS`.

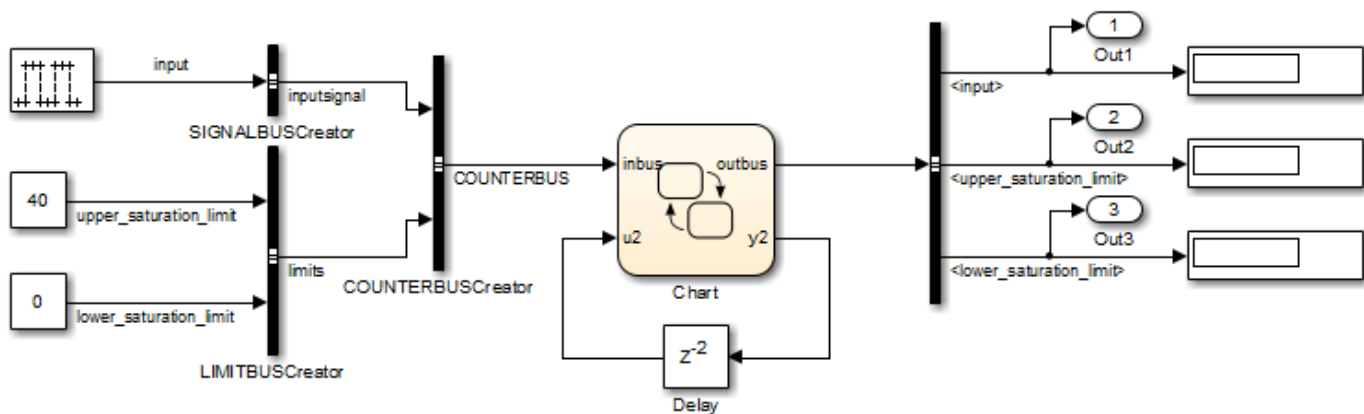

Copyright 2006-2011 The MathWorks, Inc.

The elements of a Stateflow structure data type are called *fields*. Fields can be any combination of individual signals, muxed signals, vectors, and other structures (also called substructures). Each field has its own data type. The data type does not have to match the type of any other field in the structure. For example, in the model `sfbus_demo`, each of the structures `inbus` and `outbus` has two fields:

- `inputsignal` is a substructure with one field, `input`.
- `limits` is a substructure with two fields, `upper_saturation_limit` and `lower_saturation_limit`.

Define Stateflow Structures

- 1 To define the structure data type, create a Simulink bus object in the base workspace, as described in “Create and Specify Simulink.Bus Objects” (Simulink).
- 2 Add a data object to the chart, as described in “Add Stateflow Data” on page 9-2.

To define temporary structures in truth tables, graphical functions, and MATLAB functions, add a data object *to your function*. For more information, see “Add Data Through the Model Explorer” on page 9-3.

- 3 Set the **Scope** property for the structure. Your choices are:
 - Input
 - Output
 - Local
 - Parameter
 - Temporary
- 4 Set the **Type** property for the structure. Depending on its scope, a Stateflow structure can have one of these data types.

Type	Description
Inherit: Same as Simulink	<p>This option is available for input structures only. The input structure inherits its data type from the Simulink bus signal in your model that connects to it. The Simulink bus signal must be a nonvirtual bus. For more information, see “Virtual and Nonvirtual Buses” on page 26-5.</p> <p>In the base workspace, specify a <code>Simulink.Bus</code> object with the same properties as the bus signal that connects to the Stateflow input structure. These properties must match:</p> <ul style="list-style-type: none"> • Number, name, and type of inputs • Dimension • Sample Time • Complexity • Sampling Mode <p>If the input signal comes from a Bus Creator block, in the Bus Creator dialog box, specify an appropriate bus object for Output data type field. When you specify the bus object, Simulink verifies that the properties of the <code>Simulink.Bus</code> object in the base workspace match the properties of the Simulink bus signal.</p>
Bus: <object name>	<p>In the Type field, replace <<i>object name</i>> with the name of the <code>Simulink.Bus</code> object that defines the Stateflow structure.</p> <p>For input or output structures, you are not required to specify the bus signal in your Simulink model that connects to the Stateflow structure. If you do specify a bus signal, its properties must match the <code>Simulink.Bus</code> object that defines the Stateflow structure.</p>
<data type expression>	<p>In the Type field, replace <<i>data type expression</i>> with an expression that evaluates to a data type. For example:</p> <ul style="list-style-type: none"> • Enter the name of the <code>Simulink.Bus</code> object that defines the Stateflow structure. • For structures with scopes other than Output, use the Stateflow type operator to copy the type of another structure. For more information, see “Specify Structure Types by Calling the type Operator” on page 26-4.

For example, in the `sfbus_demo` model, the input structure `inbus` and the output structure `outbus` derive their type through a type specification of the form `Bus: COUNTERBUS`.

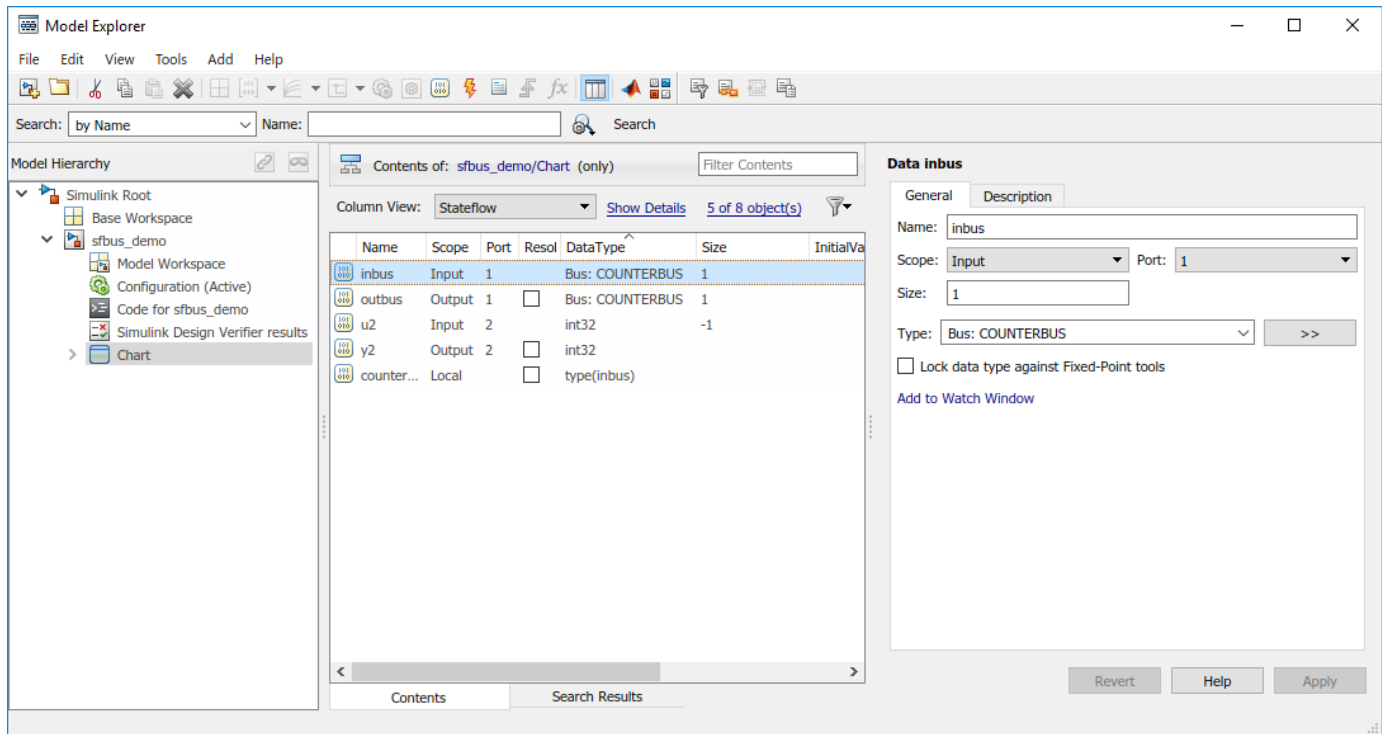

Specify Structure Types by Calling the type Operator

To specify structure types, you can use expressions that call the Stateflow type operator. This operator sets the type of one structure to the type of another structure in the Stateflow chart. For example, in the `sf_bus_demo` model, a type operator expression specifies the type of the local structure `counterbus_struct` in terms of the input structure `inbus`. Both structures are defined from the Simulink.Bus object `COUNTERBUS`. For more information, see “Derive Data Types from Other Data Objects” on page 9-30.

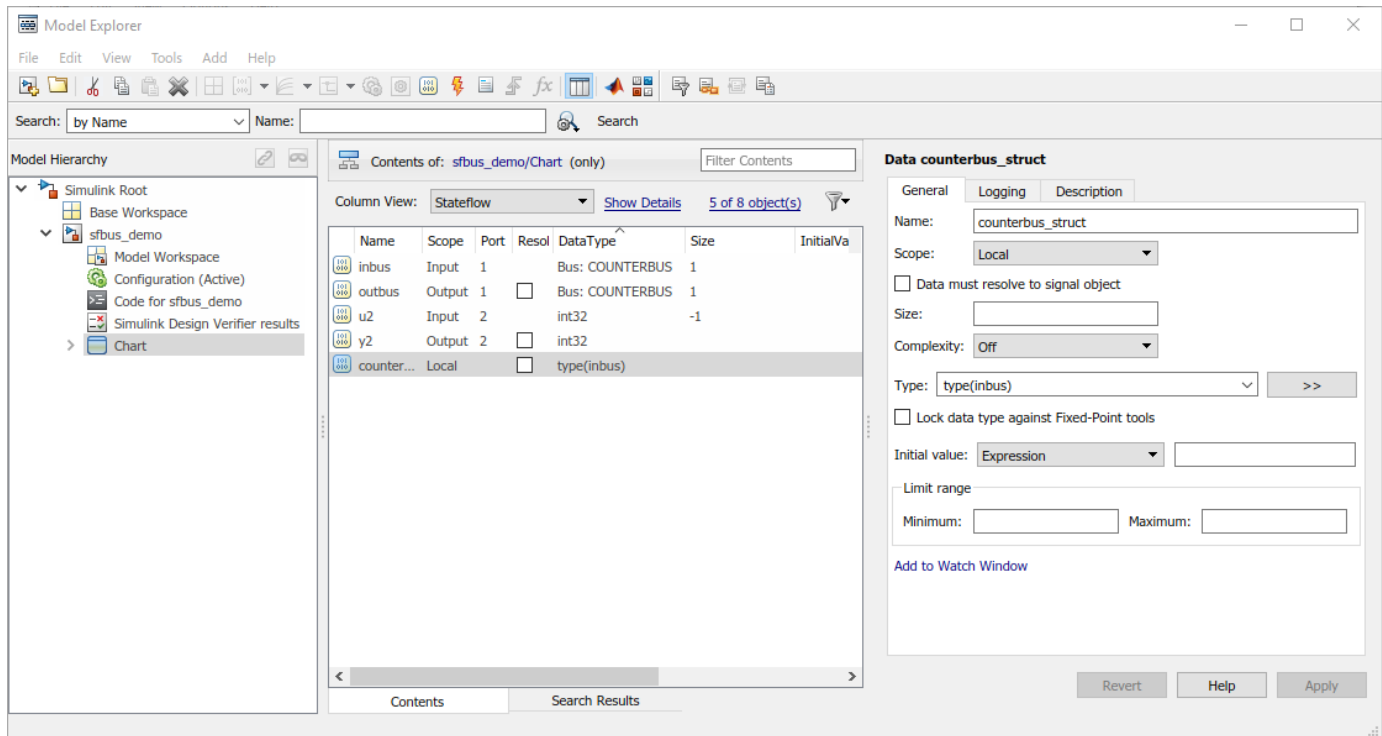

Virtual and Nonvirtual Buses

Simulink models support virtual and nonvirtual buses. Nonvirtual buses read their inputs from data structures stored in contiguous memory. Virtual buses read their inputs from noncontiguous memory. For more information, see “Types of Composite Signals” (Simulink).

Stateflow charts support only nonvirtual buses. Stateflow input structures can accept virtual bus signals and convert them to nonvirtual bus signals. Stateflow input structures cannot inherit properties from virtual bus signals. If the input to a chart is a virtual bus, set the **Type** property of the input structure through a type specification of the form `Bus: <object name>`.

Debug Structures

To debug a Stateflow structure, open the Stateflow Breakpoints and Watch window and examine the values of structure fields during simulation. To view the values of structure fields at the command line, use dot notation to index into the structure. For more information, see “Inspect and Modify Data and Messages While Debugging” on page 33-9 and “Index Substructures and Fields” on page 26-7.

Guidelines for Structure Data Types

- Define each structure from a `Simulink.Bus` object in the base workspace.
- Structures cannot have a constant scope.
- Structures of parameter scope must be tunable.
- Data array objects cannot contain structures.

- You cannot define structures for Stateflow machines. For more information, see “Overview of Stateflow Objects” on page 2-2.

See Also

Simulink.Bus

Related Examples

- “Interface Simulink Bus Signals and Integrate Custom C Code”

More About

- “Index and Assign Values to Stateflow Structures” on page 26-7
- “Integrate Custom Structures in Stateflow Charts” on page 26-10
- “Add Stateflow Data” on page 9-2
- “Derive Data Types from Other Data Objects” on page 9-30
- “Inspect and Modify Data and Messages While Debugging” on page 33-9
- “Create and Specify Simulink.Bus Objects” (Simulink)
- “Types of Composite Signals” (Simulink)

Index and Assign Values to Stateflow Structures

Stateflow structures enable you to bundle data of different size and type together into a single `Simulink.Bus` object. Using dot notation and numeric indices, you can access and modify the contents of a Stateflow structure. For more information, see “Access Bus Signals Through Stateflow Structures” on page 26-2.

Index Substructures and Fields

To index substructures and fields of Stateflow structures, use dot notation. The first part of a name identifies the parent object. Subsequent parts identify the children along a hierarchical path. When the parent is a structure, its children are individual fields or fields that contain other structures (also called substructures). The names of the fields of a Stateflow structure match the names of the elements of the `Simulink.Bus` object that defines the structure.

For example, the C chart in this model contains an input structure `in`, an output structure `out`, and a local structure `subbus`.

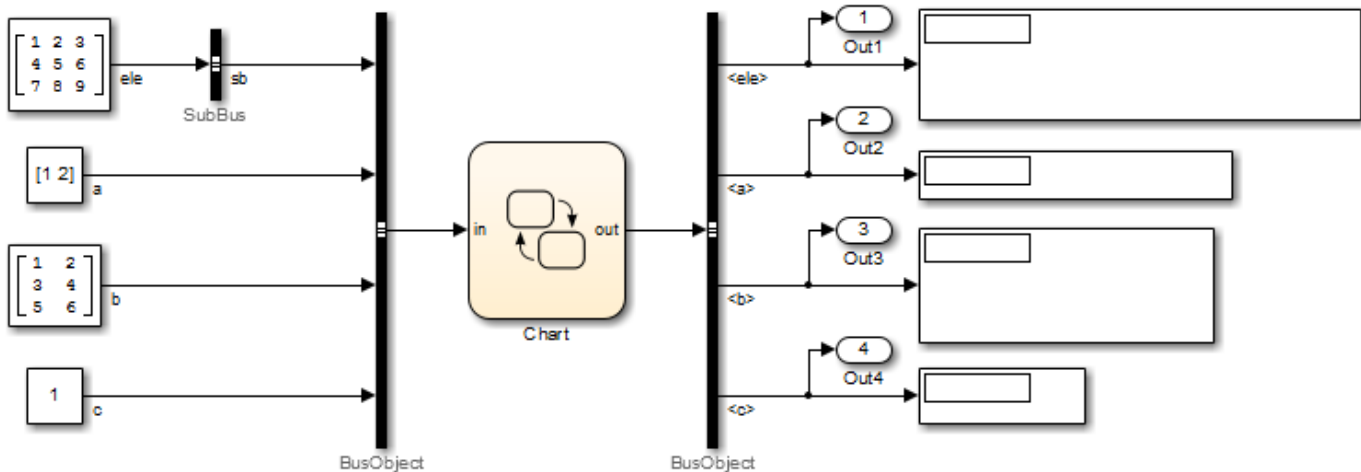

Structure	Scope	Simulink.Bus Object
in	Input	BusObject
out	Output	BusObject
subbus	Local	SubBus

The fields of the input structure `in` and the output structure `out` have the same name as the elements of `Simulink.Bus` object `BusObject` that defines them: `sb`, `a`, `b`, and `c`. The field of the local structure `subbus` has the same name `ele` as the element of `Simulink.Bus` object `SubBus`. This table lists how the Stateflow chart resolves symbols in dot notation for indexing the fields of these structures.

Dot Notation	Symbol Resolution
<code>in.c</code>	Field <code>c</code> of input structure <code>in</code>
<code>out.sb</code>	Substructure <code>sb</code> of output structure <code>out</code>

Dot Notation	Symbol Resolution
<code>in.a[0]</code>	First value of the vector field <code>a</code> of input structure <code>in</code>
<code>subbus.ele[1][1]</code>	Value in the second row, second column of field <code>ele</code> of local structure <code>subbus</code>
<code>in.sb.ele[2][3]</code>	Value in the third row, fourth column of field <code>ele</code> of substructure <code>in.sb</code>

Note In this example, the Stateflow chart uses brackets and zero-based indexing for vectors and arrays because C is the action language for the chart. For more information, see “Differences Between MATLAB and C as Action Language Syntax” on page 14-5.

Assign Values to Structures and Fields

You can assign values to any Stateflow structure, substructure, or a field of a structure with a scope different from Input.

- To assign one structure to another structure, define both structures from the same `Simulink.Bus` object in the base workspace.
- To assign one structure to a substructure of a different structure (or vice versa), define the structure and substructure from the same `Simulink.Bus` object.
- To assign a field of one structure to a field of another structure, the fields must have the same type and size. You can define the Stateflow structures from different `Simulink.Bus` objects.

This table presents valid and invalid structure assignments based on the structure specifications for the previous example.

Assignment	Valid or Invalid?	Explanation
<code>in = out;</code>	Invalid	You cannot write to input structures.
<code>out = in;</code>	Valid	Both <code>in</code> and <code>out</code> are defined from the same <code>Simulink.Bus</code> object <code>BusObject</code> .
<code>subbus = in;</code>	Invalid	The structures <code>subbus</code> and <code>in</code> are defined from different <code>Simulink.Bus</code> objects.
<code>in.sb = subbus;</code>	Invalid	You cannot write to substructures of input structures.
<code>out.sb = subbus;</code>	Valid	The substructure <code>out.sb</code> and the structure <code>subbus</code> are defined from the same <code>Simulink.Bus</code> object <code>SubBus</code> .
<code>in.c = out.c;</code>	Invalid	You cannot write to fields of input structures.
<code>out.sb.ele = subbus.ele;</code>	Valid	The field <code>out.sb.ele</code> has the same type and size as the field <code>subbus.ele</code> (3-by-3 matrices).
<code>subbus.ele[1][1] = in.c;</code>	Valid	The field <code>subbus.ele[1][1]</code> has the same type and size as the field <code>in.c</code> (scalars).

See Also

Simulink.Bus

More About

- “Access Bus Signals Through Stateflow Structures” on page 26-2
- “Identify Data by Using Dot Notation” on page 9-39

Integrate Custom Structures in Stateflow Charts

You can define custom structures in C code, which you can integrate with your Stateflow chart in a Simulink model for simulation and code generation. For example, the model `sf_bus_demo` uses a custom C function to write to the output structure `outbus`. By sharing data with custom code, you can augment the capabilities supported by Stateflow and take advantage of your preexisting code. For more information, see “Reuse Custom Code in Stateflow Charts” on page 31-19 and “Access Bus Signals Through Stateflow Structures” on page 26-2.

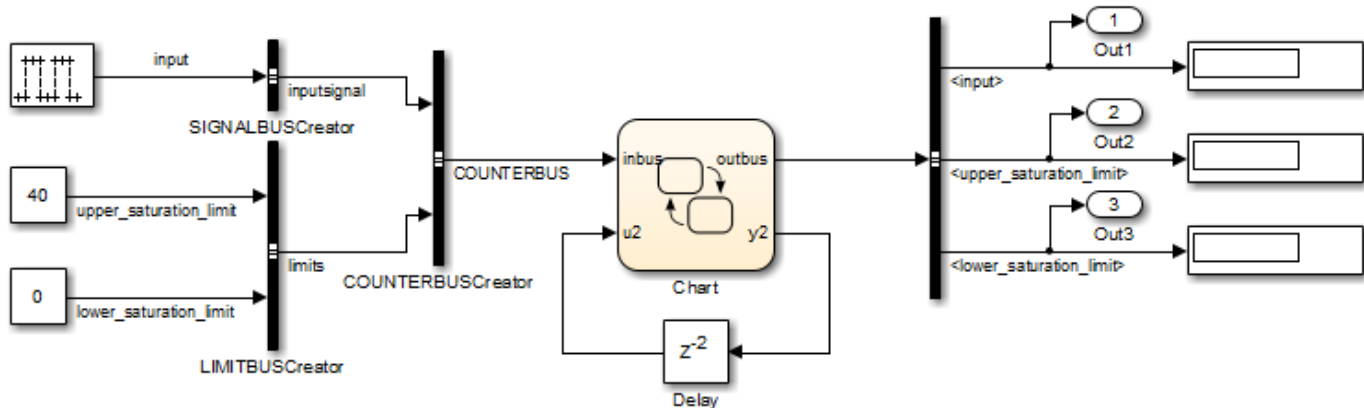

Copyright 2006-2011 The MathWorks, Inc.

Define Custom Structures in C Code

- 1 In your C code, define a structure by creating a custom header file. The header file contains typedef declarations matching the properties of the `Simulink.Bus` object that defines the Stateflow structure. For example, in the model `sfbus_demo`, the header file `counterbus.h` declares three custom structures:

```
...
typedef struct {
    int input;
} SIGNALBUS;

typedef struct {
    int upper_saturation_limit;
    int lower_saturation_limit;
} LIMITBUS;

typedef struct {
    SIGNALBUS inputsignal;
    LIMITBUS limits;
} COUNTERBUS;
...
```

- 2 In the Bus Editor, define a `Simulink.Bus` object that matches each custom structure typedef declaration. In the **Header file** field of each `Simulink.Bus` object, enter the name of the header file that contains the matching typedef declaration.

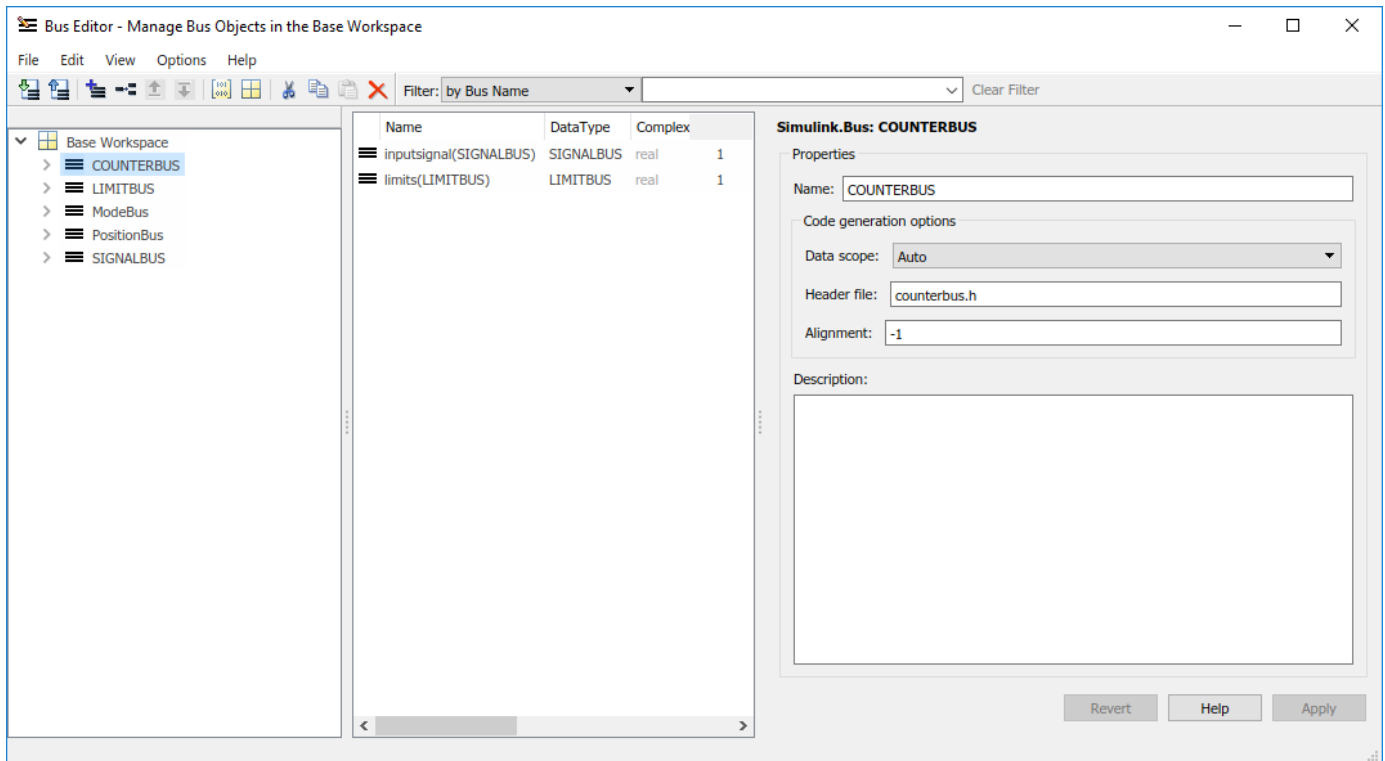

- 3 Configure your C action language chart to include custom C code.
 - To include custom code for simulation, see “Access Custom C Code in Nonlibrary Charts” on page 31-4.
 - To include custom code for code generation, see “Integrate External Code by Using Model Configuration Parameters” (Simulink Coder).
- 4 Build and run your model.

Pass Stateflow Structures to Custom Code

When you write custom code functions that take structure pointers as arguments, pass the Stateflow structures by address. To pass the address of a Stateflow structure or one of its fields to a custom function, use the `&` operator and dot notation:

- `&outbus` provides the address of the Stateflow structure `outbus`.
- `&outbus.inputsignal` provides the address of the substructure `inputsignal` of the structure `outbus`.
- `&outbus.inputsignal.input` provides the address of the field `input` of the substructure `outbus.inputsignal`.

For more information, see “Index Substructures and Fields” on page 26-7.

For instance, the model `sfbus_demo` contains a custom C function `counterbusFcn` that takes structure pointers as arguments. The custom header file contains this function declaration:

```
extern void counterbusFcn
    (COUNTERBUS *u1, int u2, COUNTERBUS *y1, int *y2);
```

The chart passes the addresses to the Stateflow structures `counterbus_struct` and `outbus` by using this function call:

```
counterbusFcn(&counterbus_struct, u2, &outbus, &y2);
```

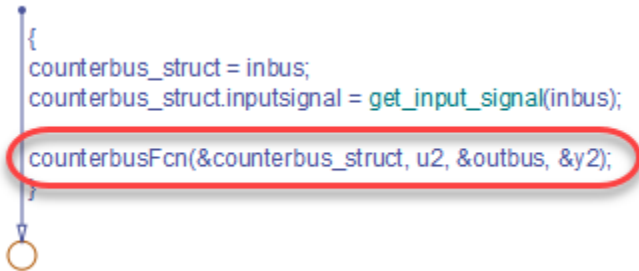

```
{
counterbus_struct = inbus;
counterbus_struct.inputsignal = get_input_signal(inbus);
counterbusFcn(&counterbus_struct, u2, &outbus, &y2);
}
```

The function reads the value of the chart input `u2` and the local structure `counterbus_struct`. It writes to the chart output `y2` and the output structure `outbus`.

See Also

`Simulink.Bus`

Related Examples

- “Interface Simulink Bus Signals and Integrate Custom C Code”

More About

- “Access Bus Signals Through Stateflow Structures” on page 26-2
- “Index and Assign Values to Stateflow Structures” on page 26-7
- “Reuse Custom Code in Stateflow Charts” on page 31-19
- “Integrate External Code by Using Model Configuration Parameters” (Simulink Coder)
- “Identify Data by Using Dot Notation” on page 9-39

Stateflow Design Patterns

- “Reduce Transient Signals by Using Debouncing Logic” on page 27-2
- “Schedule Execution of Simulink Subsystems” on page 27-9
- “Schedule Multiple Subsystems in a Single Step” on page 27-10
- “Schedule a Subsystem Multiple Times in a Single Step” on page 27-14
- “Schedule Subsystems to Execute at Specific Times” on page 27-17
- “Implement Dynamic Test Vectors” on page 27-20
- “Map Fault Conditions to Actions by Using Truth Tables” on page 27-28
- “Design for Isolation and Recovery in a Chart” on page 27-31

Reduce Transient Signals by Using Debouncing Logic

Why Debounce Signals

When a switch opens and closes, the switch contacts can bounce off each other before the switch completely transitions to an on or off state. The bouncing action can produce transient signals that do not represent a true change of state. Therefore, when modeling switch logic, it is important to filter out transient signals by using *debouncing* algorithms.

If you model a controller in a Stateflow chart, you do not want your switch logic to overwork the controller by turning it on and off in response to every transient signal it receives. To avoid this, design a Stateflow controller that uses temporal logic to debounce your input signals and determine whether a switch is actually on or off.

How to Debounce a Signal

There are two ways to debounce a signal by using Stateflow:

- 1 Filter out transient signals by using the `duration` temporal operator.
- 2 Filter out transient signals by using an intermediate graphical state. Use intermediate graphical state for advanced filtering techniques, such as fault detection.

The `duration` operator is supported only in Stateflow charts in a Simulink model.

Debounce Signals with the `duration` Operator

The model `sf_debouncer_using_duration` illustrates a design pattern that uses the `duration` operator to filter out transient signals.

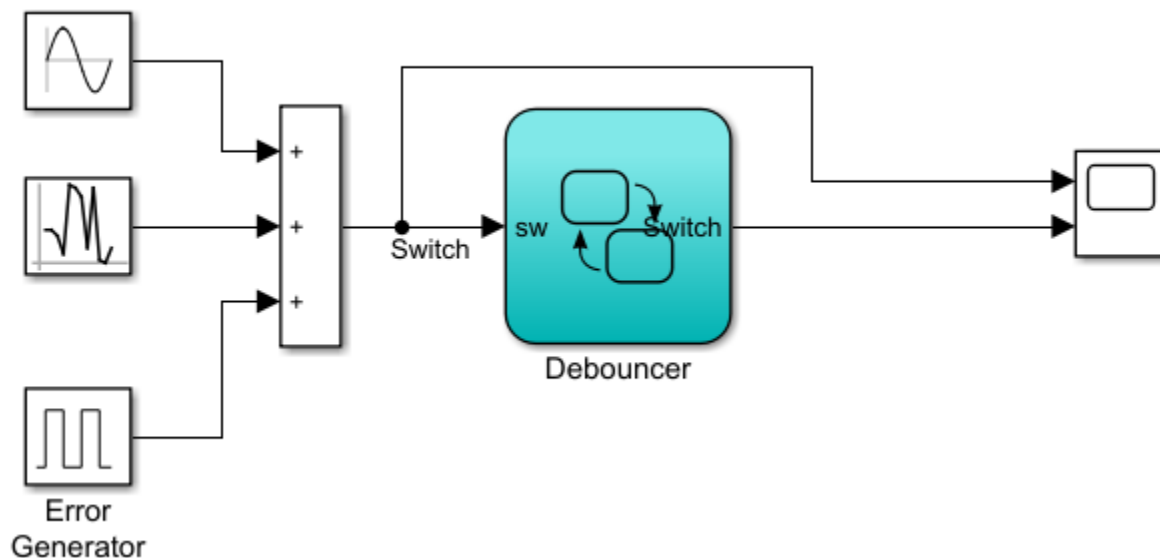

The Debouncer chart contains this logic.

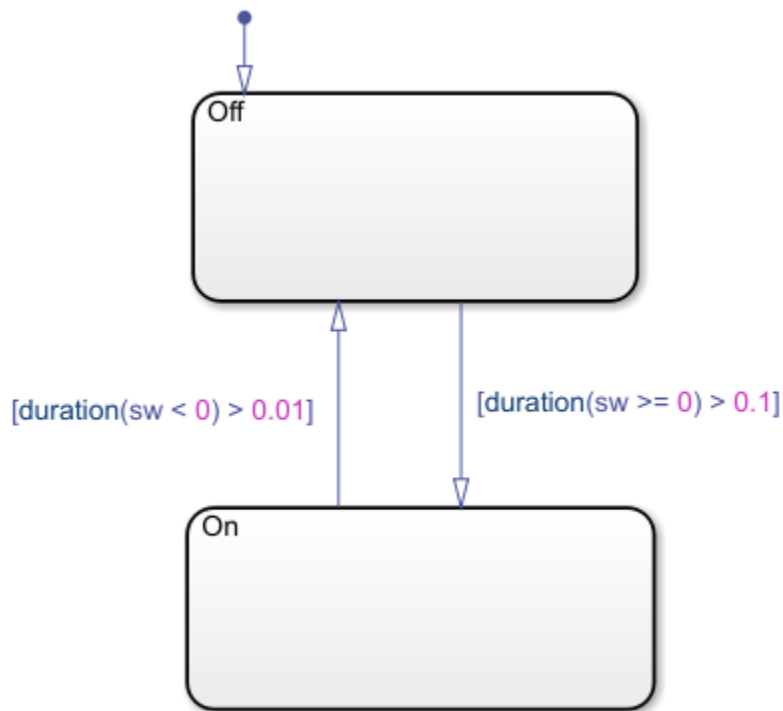

The debouncer design uses the `duration(n)` statement to implement absolute-time temporal logic.

The initial state for this model is **Off**. Using the `duration` operator, you can control what state the model is in based on how long the switch signal, `sw`, has been greater or less than zero. Once `sw` has been greater than or equal to zero for longer than 0.1 seconds, the switch moves from state **Off** to state **On**. Then, if `sw` has been less than zero for longer than 0.01 seconds, the switch moves from state **On** to state **Off**.

State Logic

The debouncer has two states, **On** and **Off**. The `duration` operator controls which state is active. The logic works as described in this table.

Input Signal	State	Result
Retains positive value for 0.1 second	On	Switch turns on
Retains negative value for 0.01 second	Off	Switch turns off

Run the Debouncer

- 1 Open the `sf_debouncer_using_duration` model.
- 2 Open the Stateflow chart **Debouncer** and the **Scope** block.
- 3 Simulate the chart.

The scope shows how the debouncer isolates transient signals from the noisy input signal.

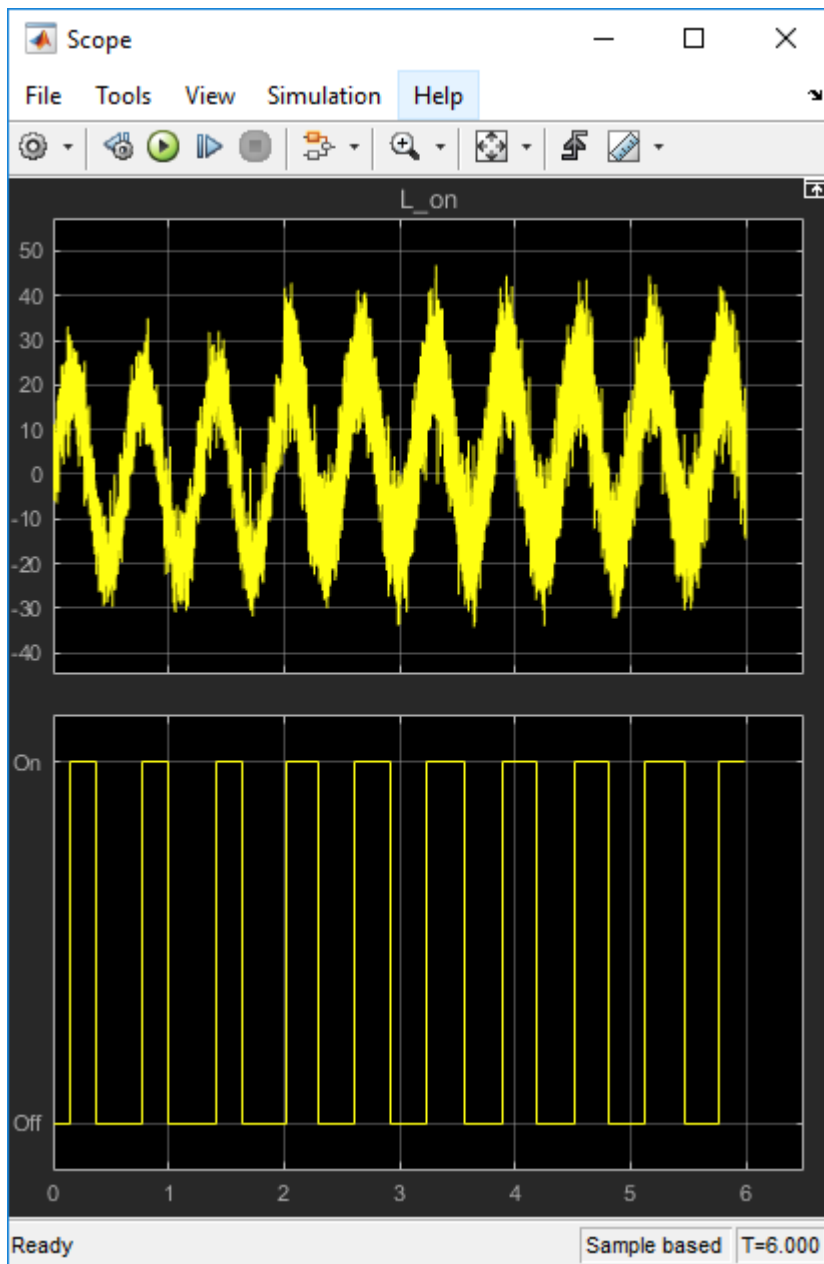

Debounce Signals with Fault Detection

The model `sf_debouncer` illustrates a design pattern that uses temporal logic and an intermediate state to isolate transient signals. With this design pattern, you can also include logic to detect faults and allow your system time to recover.

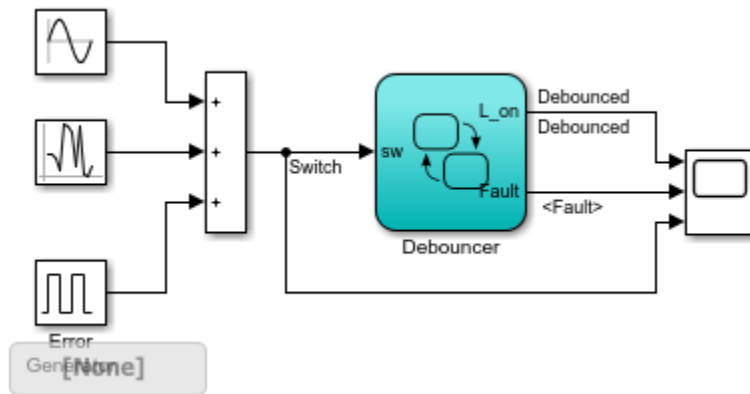

The Debouncer chart contains this logic.

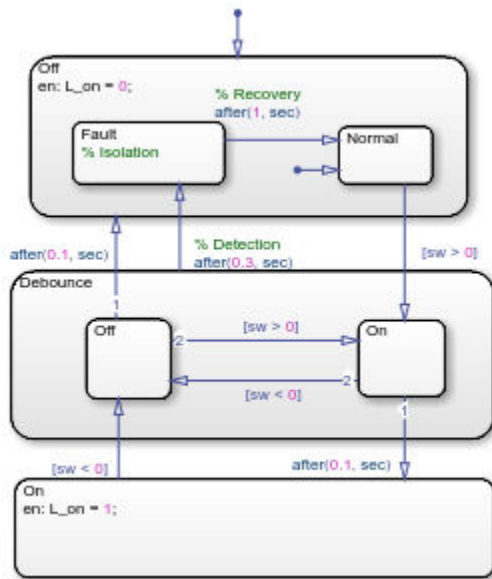

The debouncer design uses the `after(n, sec)` statement to implement absolute-time temporal logic. The keyword `sec` defines simulation time that has elapsed since activation of a state.

State Logic

The debouncer chart contains an intermediate state called Debounce. The Debounce state isolates transient inputs by checking whether the signals retain their positive or negative values, or fluctuate between zero crossings over a prescribed period. The logic works as shown in this table.

Input Signal	State	Transitions	Result
Retains positive value for 0.1 second	Debounce.On	On	Switch turns on
Retains negative value for 0.1 second	Debounce.Off	Off	Switch turns off

Input Signal	State	Transitions	Result
Fluctuates between zero crossings for 0.3 second	Debounce	Off.Fault	Chart isolates the input as a transient signal and gives it time to recover.
		Note The Debounce to Off.Fault transition comes from a higher level in the chart hierarchy and overrides the transitions from the Debounce.Off and Debounce.On substates.	

Run the Debouncer

- 1 Open the sf_debouncer.
- 2 Open the Stateflow chart Debouncer and the Scope block.
- 3 Simulate the chart.

The scope shows how the debouncer isolates transient signals from the noisy input signal.

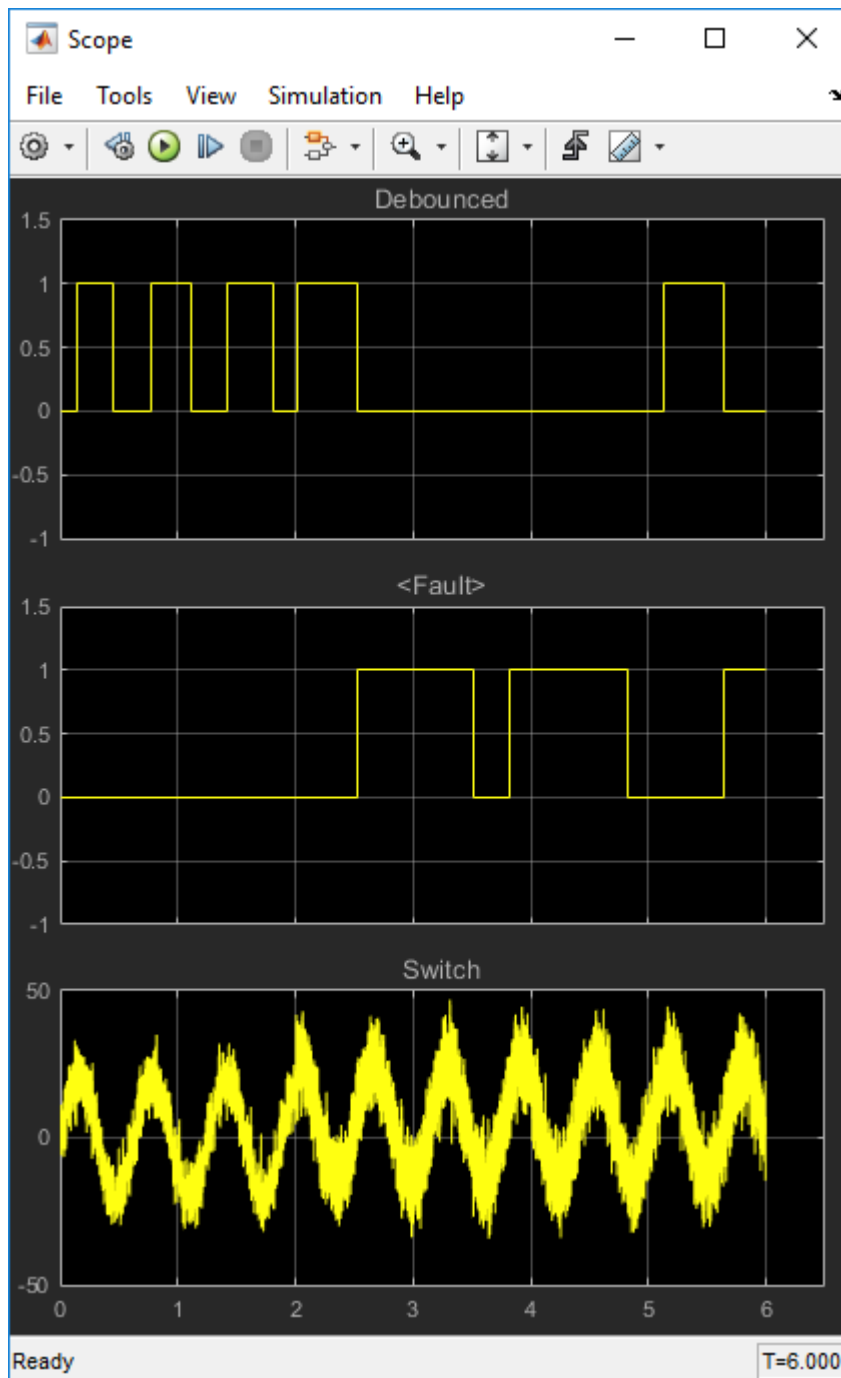

Use Event-Based Temporal Logic

As an alternative to absolute-time temporal logic, you can apply event-based temporal logic to determine true state in the Debouncer chart by using the `after(n, tick)` statement. The keyword `tick` specifies and implicitly generates a local event when the chart awakens.

The Error Generator block in the `sf_debouncer` model generates a pulse signal every 0.001 second. Therefore, to convert the absolute-time temporal logic specified in the Debouncer chart to event-based logic, multiply the n argument by 1000, as follows.

Absolute Time-Based Logic	Event-Based Logic
<code>after (0.1, sec)</code>	<code>after (100, tick)</code>
<code>after (0.3, sec)</code>	<code>after (300, tick)</code>
<code>after (1, sec)</code>	<code>after (1000, tick)</code>

See Also

`duration`

More About

- “Control Chart Execution by Using Temporal Logic” on page 13-40
- “Control Chart Behavior by Using Implicit Events” on page 11-23

Schedule Execution of Simulink Subsystems

When to Implement Schedulers

Use Stateflow charts to schedule the order of execution of Simulink subsystems *explicitly* in a model. Stateflow schedulers extend control of subsystem execution in a Simulink model, which determines order of execution *implicitly* based on block connectivity via sample time propagation.

Types of Schedulers

You can implement the following types of schedulers using Stateflow charts.

Scheduler Design Pattern	Description
Ladder logic scheduler on page 27-10	Schedules multiple Simulink subsystems to execute in a single time step
Loop scheduler on page 27-14	Schedules one Simulink subsystem to execute multiple times in a single time step
Temporal logic scheduler on page 27-17	Schedules Simulink subsystems to execute at specific times

Schedule Multiple Subsystems in a Single Step

This example shows how to design a *ladder logic scheduler* in Stateflow®. The ladder logic scheduler design pattern allows you to specify the order in which multiple Simulink® subsystems execute in a single time step.

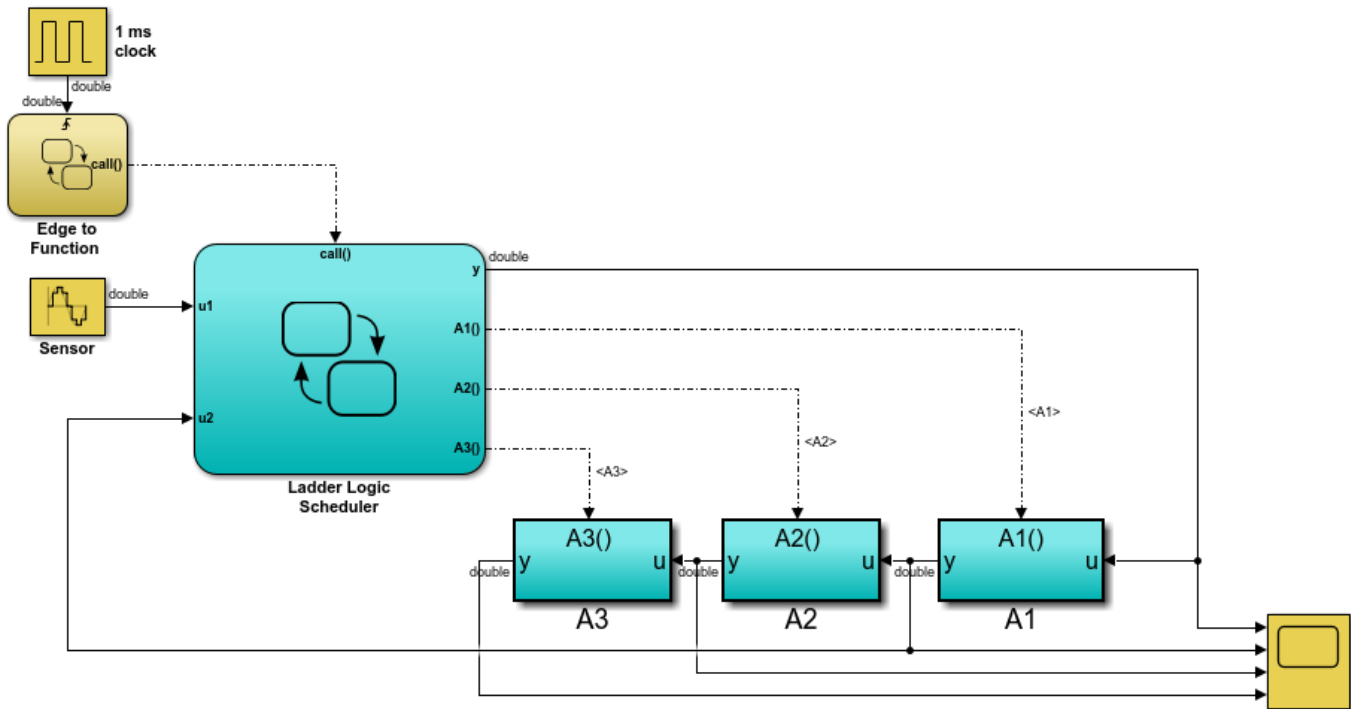

Key Behavior of the Ladder Logic Scheduler

In this example, the Ladder Logic Scheduler chart broadcasts a series of function-call output events to execute three function-call subsystems (A1, A2, and A3). During each time step:

- 1 The Simulink model activates the Edge to Function chart at the rising edge of the 1-millisecond pulse generator.
- 2 The Edge to Function chart broadcasts the function-call output event `call` to activate Ladder Logic Scheduler chart.
- 3 The Ladder Logic Scheduler chart uses sequencing ladder logic to broadcast function-call output events based on the values of the input signals `u1` and `u2`.

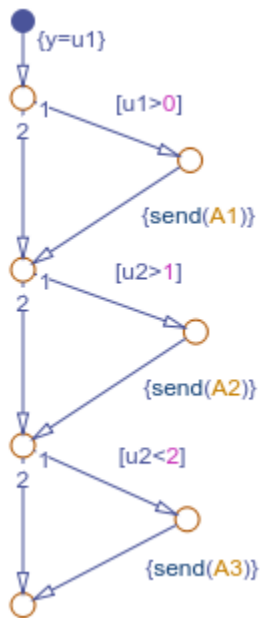

Sequencing Ladder Logic

The chart evaluates each condition sequentially. When a condition is valid, the chart calls the `send` operator to broadcast an output event. The corresponding subsystem computes its output and returns control back to the Ladder Logic Scheduler chart.

Run the Ladder Logic Scheduler

When you simulate the model, the scope shows the input and output of each function-call subsystem.

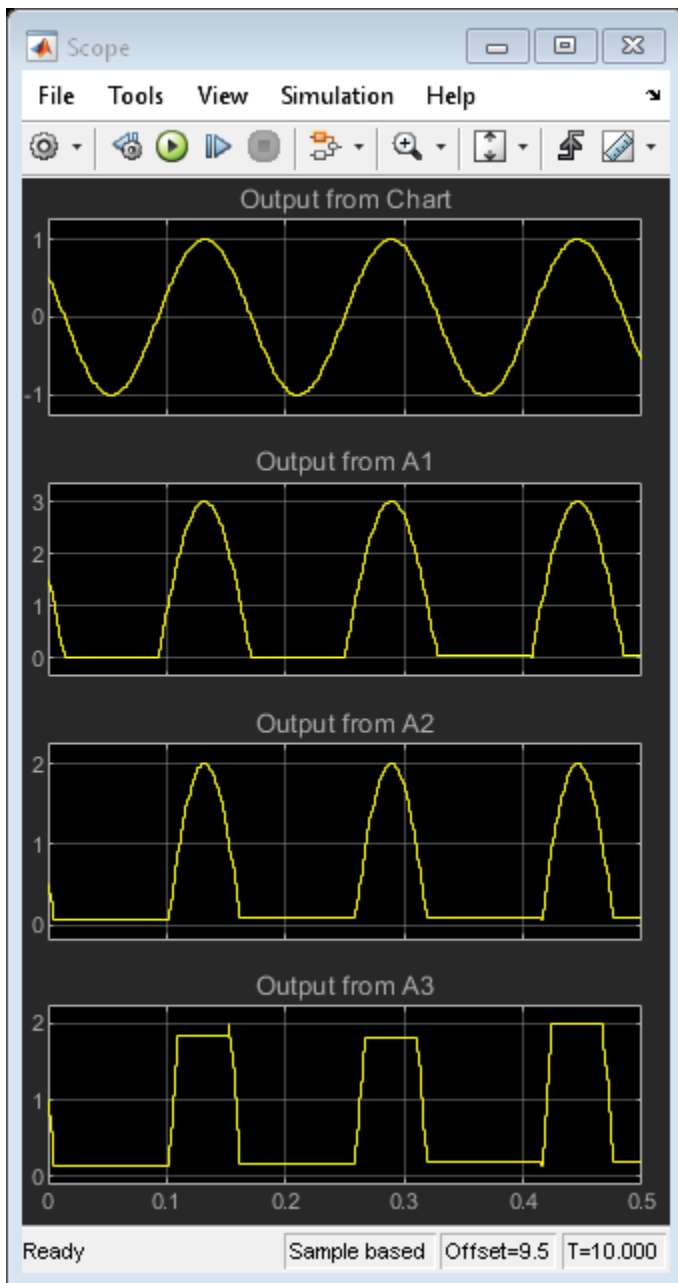

During each time step, the Ladder Logic Scheduler chart executes the subsystems depending on the values of the input signals $u1$ and $u2$:

- 1 If $u1$ is positive, the chart sends a function-call output event to execute subsystem A1. This subsystem multiplies the value of $u1$ by a gain of 3 and passes this value back to the Ladder Logic Scheduler chart as input $u2$. Control returns to the next condition in the Ladder Logic Scheduler chart.
- 2 If $u2$ is greater than 1, the chart sends a function-call output event to execute subsystem A2. This subsystem decreases the value of $u2$ by 1. Control returns to the final condition in the Ladder Logic Scheduler chart.

- 3 If u_2 is less than 2, the chart sends a function-call output event to execute subsystem A3. This subsystem multiplies its input by a gain of 2.

In the scope, horizontal segments indicate time steps when a subsystem does not execute.

See Also

send

More About

- “Activate a Stateflow Chart by Sending Input Events” on page 11-7
- “Activate a Simulink Block by Sending Output Events” on page 11-14

Schedule a Subsystem Multiple Times in a Single Step

This example shows how to design a *loop scheduler* in Stateflow®. The loop scheduler design pattern enables you to execute a Simulink® subsystem multiple times in a single time step.

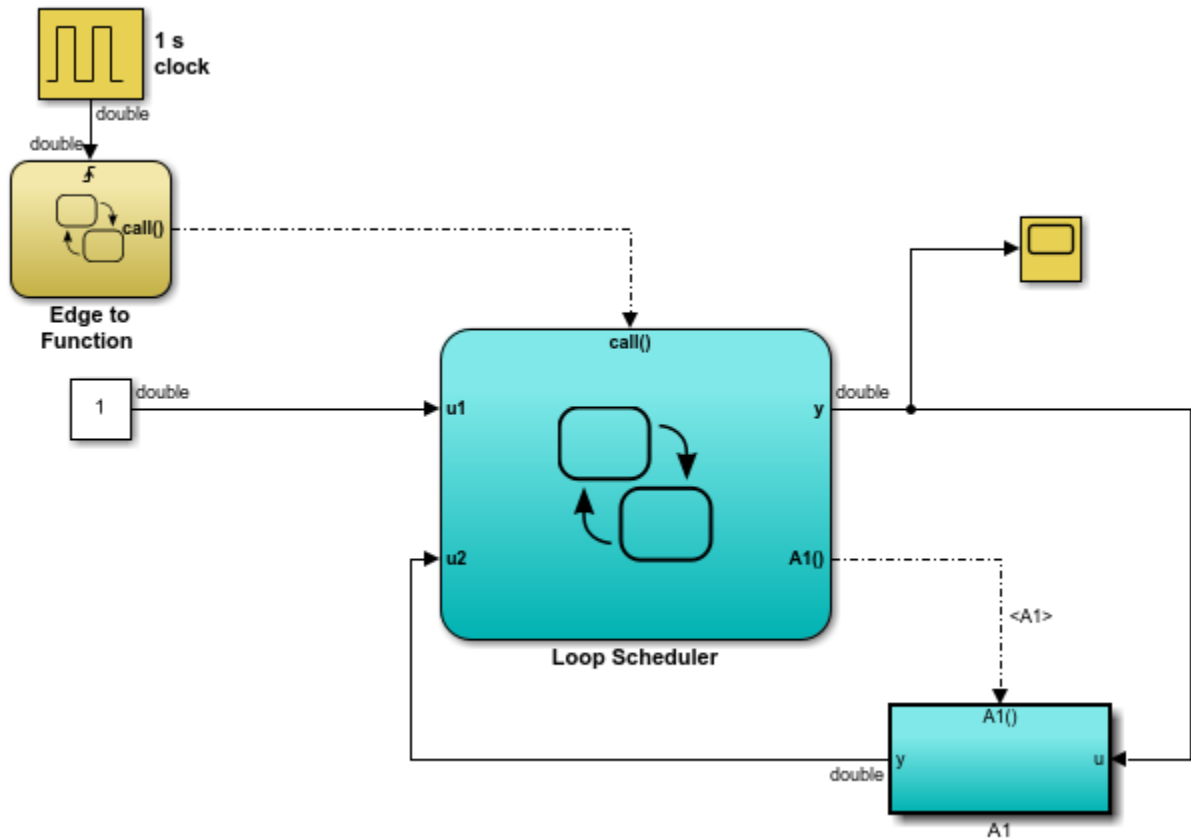

Key Behavior of the Loop Scheduler

In this example, the Loop Scheduler chart broadcasts a function-call output event to execute the function-call subsystem A1 multiple times every time step. During each time step:

- 1 The Simulink model activates the Edge to Function chart at the rising edge of the 1-millisecond pulse generator.
- 2 The Edge to Function chart broadcasts the function-call output event `call` to activate the Loop Scheduler chart.
- 3 The Loop Scheduler chart calls the `send` operator to broadcast the function-call output event `A1` multiple times.

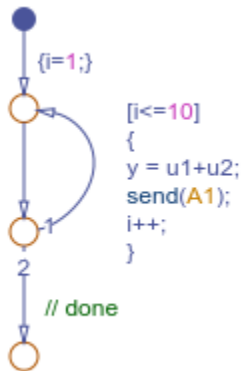

Each broadcast of the event A1 executes the subsystem A1. The subsystem computes its output and returns control back to the Loop Scheduler chart.

Run the Loop Scheduler

When you simulate the model, the scope displays the value of y at each time step.

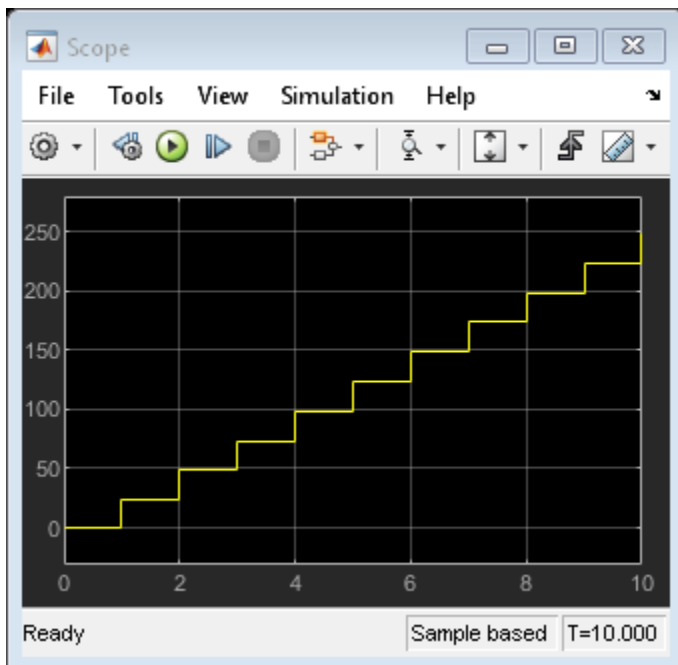

During each time step, the value of y increases by 25 because:

- The flow chart in the Loop Scheduler implements a `for` loop that iterates 10 times.
- In each iteration of the `for` loop, the chart increments y by 1 (the constant value of input $u1$).
- Each time that the chart broadcasts the output event to subsystem A1, the subsystem increments y by 1.5.

See Also

send

More About

- “Activate a Stateflow Chart by Sending Input Events” on page 11-7
- “Activate a Simulink Block by Sending Output Events” on page 11-14

Schedule Subsystems to Execute at Specific Times

This example shows how to design a *temporal logic scheduler* in Stateflow®. The temporal logic scheduler design pattern allows you to schedule Simulink® subsystems to execute at specified times.

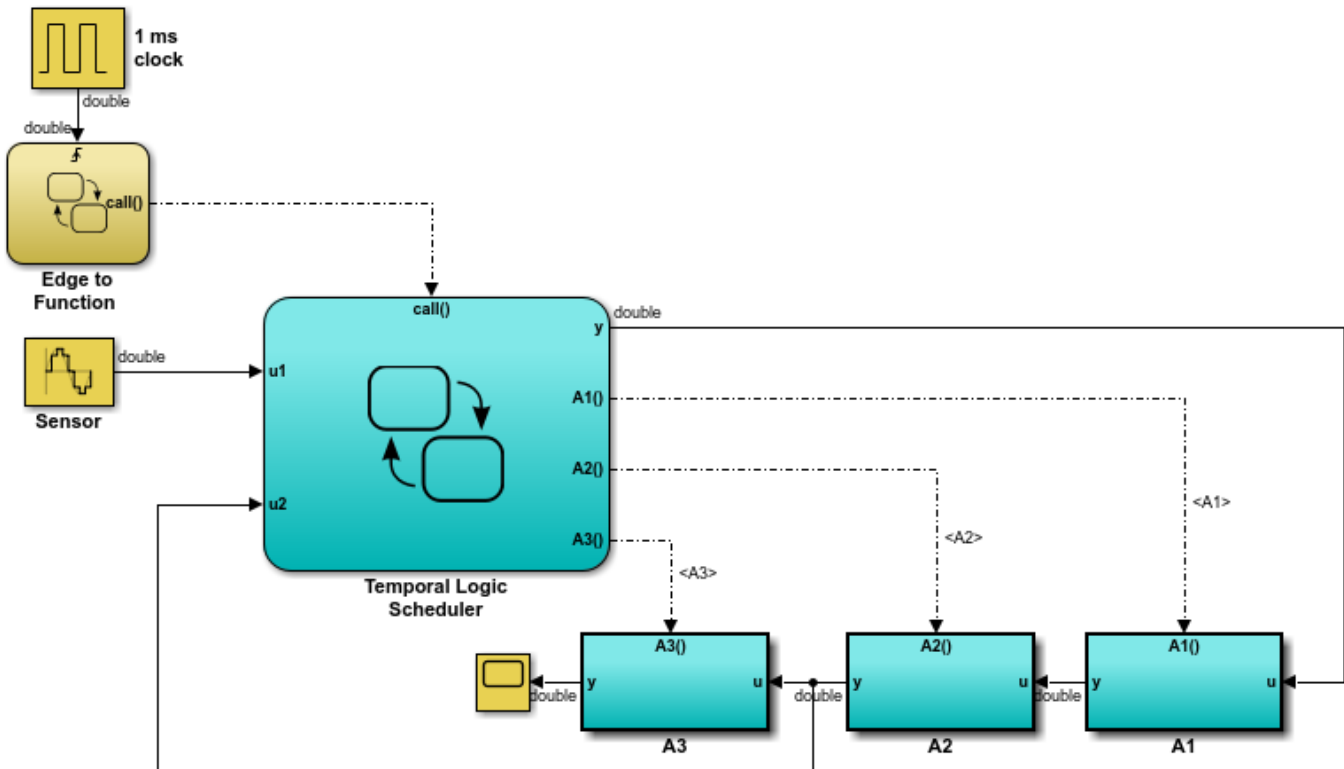

Key Behavior of the Temporal Logic Scheduler

In this example, the Temporal Logic Scheduler chart contains two states that schedule the execution of three function-call subsystems (A1, A2, and A3) at different rates, as determined by the temporal logic operator every.

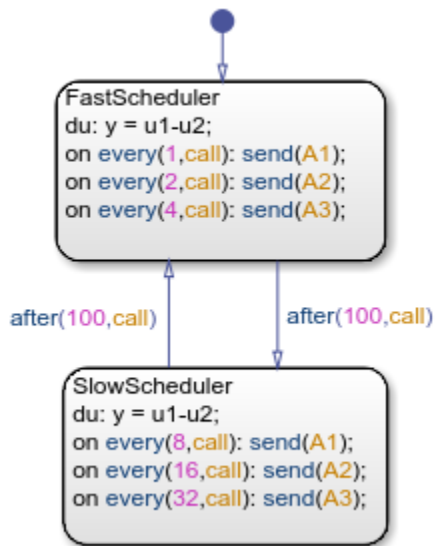

When the `FastScheduler` state is active, the chart schedules function calls to different Simulink subsystems at a fraction of the base rate at which the input event `call` wakes up the chart.

- The chart sends an event to execute subsystem A1 at the base rate.
- The chart sends an event to execute subsystem A2 at half the base rate.
- The chart sends an event to execute subsystem A3 at one quarter the base rate.

When the `SlowScheduler` state is active, the chart schedules function calls for A1, A2, and A3 at 1/8, 1/16, and 1/32 times the base rate.

The chart switches between the fast and slow execution modes after every 100 invocations of the `call` event.

Run the Temporal Logic Scheduler

When you simulate the model, the scope displays the value of `y` at each time step.

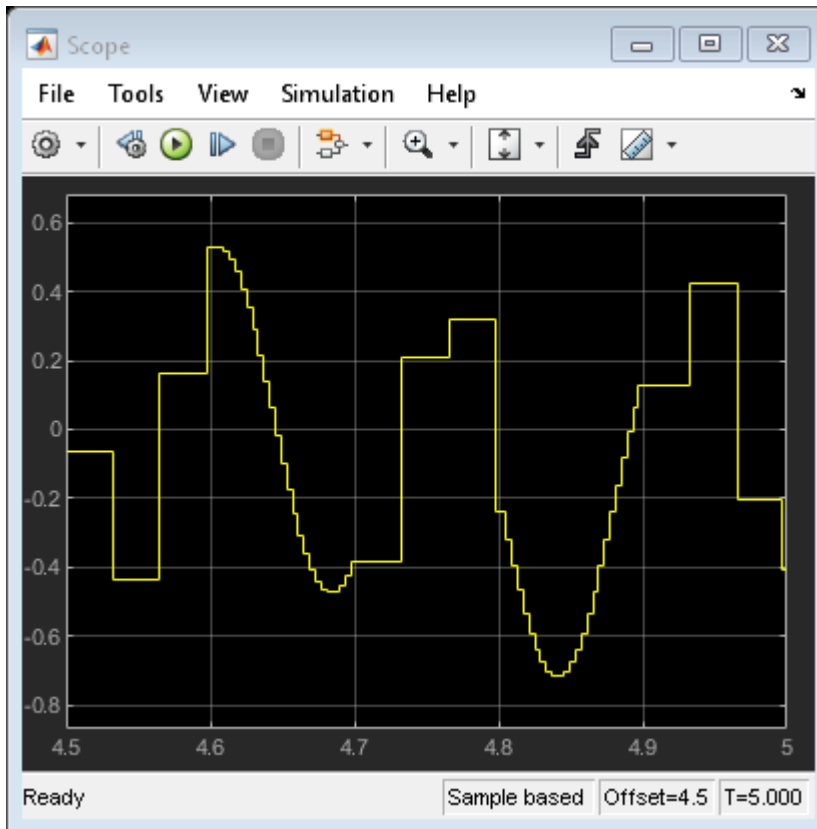

The changes in value illustrate the different rates of execution.

- When the chart executes the subsystems at a slow rate (for example, from $t = 4.5$ to $t = 4.6$, from $t = 4.7$ to $t = 4.8$, and from $t = 4.9$ to $t = 5.0$), the values change slowly.
- When the chart executes the subsystems at a fast rate (for example, from $t = 4.6$ to $t = 4.7$ and from $t = 4.8$ to $t = 4.9$), the values change rapidly.

See Also

every | send

More About

- “Control Chart Execution by Using Temporal Logic” on page 13-40
- “Activate a Stateflow Chart by Sending Input Events” on page 11-7
- “Activate a Simulink Block by Sending Output Events” on page 11-14

Implement Dynamic Test Vectors

When to Implement Test Vectors

Use Stateflow charts to create test vectors that change *dynamically* during simulation, based on the state of the system you are modeling.

For example, suppose you want to test an automatic car transmission controller in the situation where a car is coasting. To achieve a coasting state, a driver accelerates until the transmission shifts into the highest gear, then eases up on the gas pedal. To test this scenario, you could generate a signal that represents this behavior, as in the following Signal Builder block.

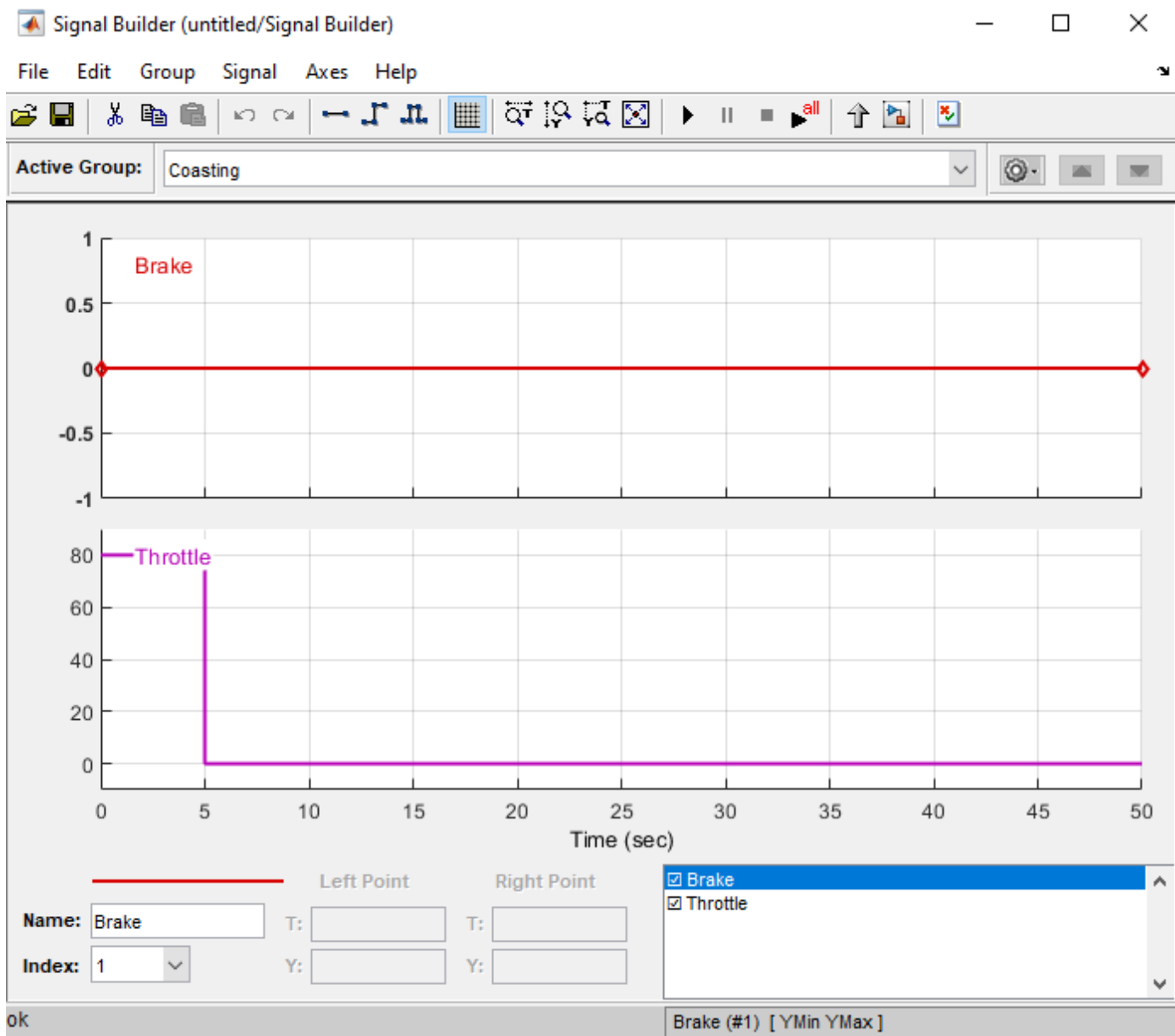

However, this approach has limitations. The signal changes value based on time, but cannot respond dynamically to changes in the system that are not governed by time alone. For example, how does the signal know when the transmission shifts into the highest gear? In this case, the signal assumes that the shift always occurs at time 5 because it cannot test for other deterministic conditions such as the speed of the vehicle. Moreover, you cannot change the signal based on outputs from the model.

By contrast, you can use Stateflow charts to develop test vectors that use conditional logic to evaluate and respond to changes in system state as they occur. For example, to test the coasting scenario, the chart can evaluate an output that represents the gear range and reduce speed only after the transmission shifts to the highest gear. That is, the car slows down as a direct result of the gear shift and not at a predetermined time.

A Dynamic Test Vector Chart

The following model of an automatic transmission controller uses a Stateflow chart to implement test vectors that represent brake, throttle, and gear shift dynamics. The chart, called Dynamic Test Vectors, interfaces with the rest of the model as shown.

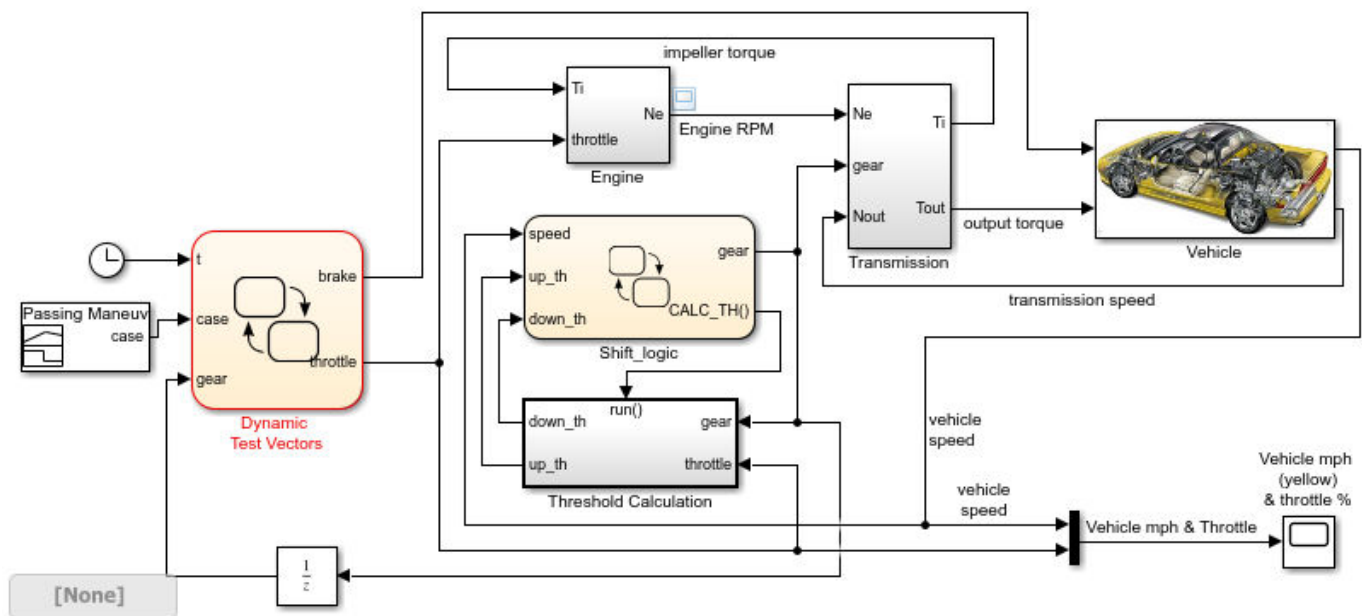

The chart models the dynamic relationship between the brake and throttle to test four driving scenarios. Each scenario is represented by a state.

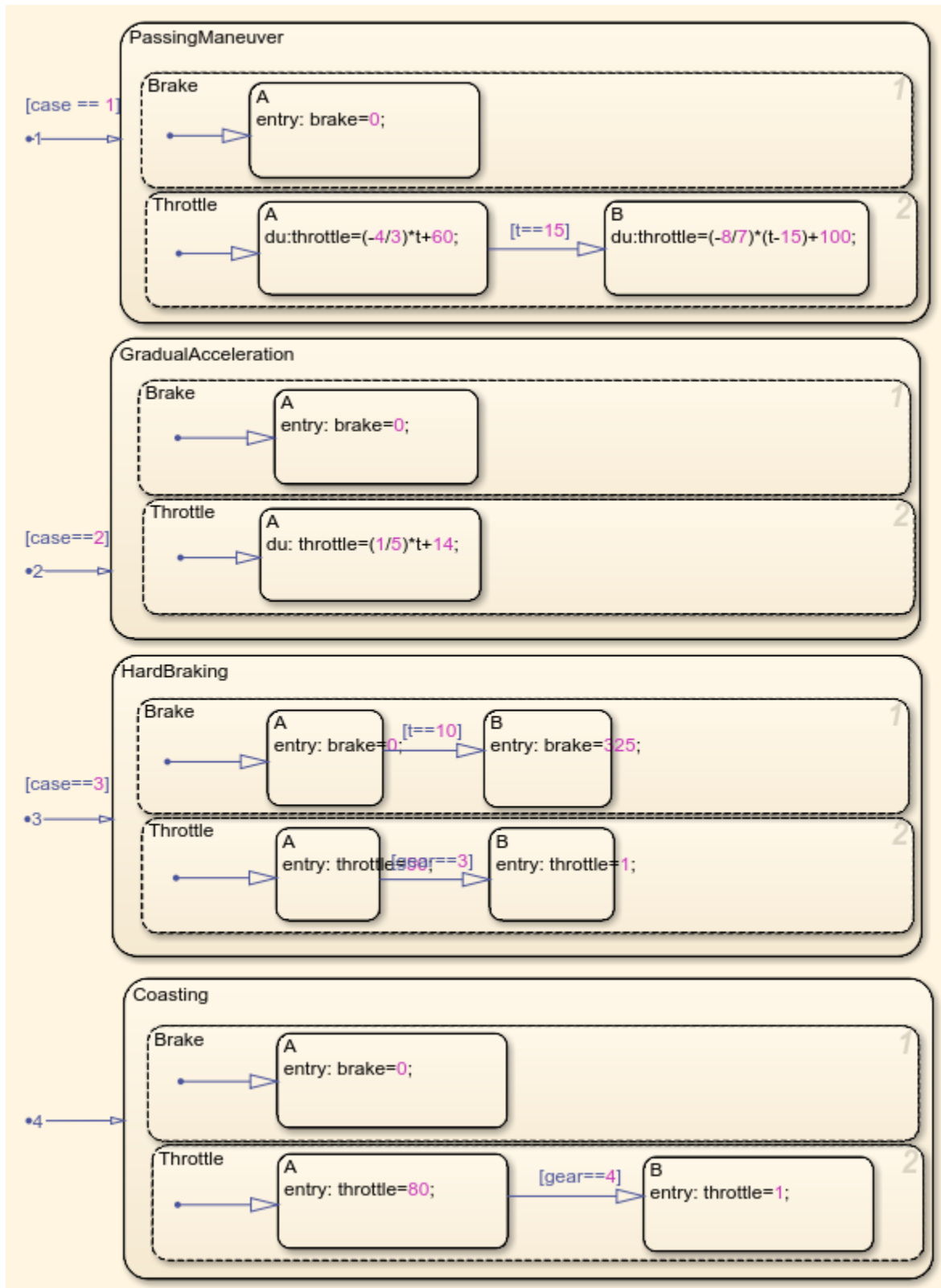

In some of these scenarios, the throttle changes in response to time; in other cases, it responds to gear selection, an output of the Stateflow chart Shift_logic. The Shift_logic chart determines the gear value based on the speed of the vehicle.

Key Behaviors of the Chart and Model

The key behaviors of the test vector chart and model are:

- “Chart Represents Test Cases as States” on page 27-23
- “Chart Uses Conditional Logic to Respond to Dynamic Changes” on page 27-23
- “Model Provides an Interface for Selecting Test Cases” on page 27-23

Chart Represents Test Cases as States

The Dynamic Test Vectors chart represents each test case as an exclusive (OR) state. Each state manipulates brake and throttle values in a unique way, based on the time and gear inputs to the chart.

The chart determines which test to execute from the value of a constant signal case, output from the Signal Builder block. Each test case corresponds to a unique signal value.

Chart Uses Conditional Logic to Respond to Dynamic Changes

The Dynamic Test Vectors chart uses conditions on transitions to test time and gear level, and then adjusts brake and throttle accordingly for each driving scenario. Stateflow charts provide many constructs for testing system state and responding to changes, including:

- Conditional logic (see “State Action Types” on page 13-2 and “Transition Action Types” on page 13-7)
- Temporal logic (see “Control Chart Execution by Using Temporal Logic” on page 13-40)
- Change detection operators (see “Detect Changes in Data Values” on page 13-56)
- MATLAB functions (see “Access MATLAB Functions and Workspace Data in C Charts” on page 13-28)

Model Provides an Interface for Selecting Test Cases

The model uses a Signal Builder block to provide an interface for selecting test scenarios to simulate.

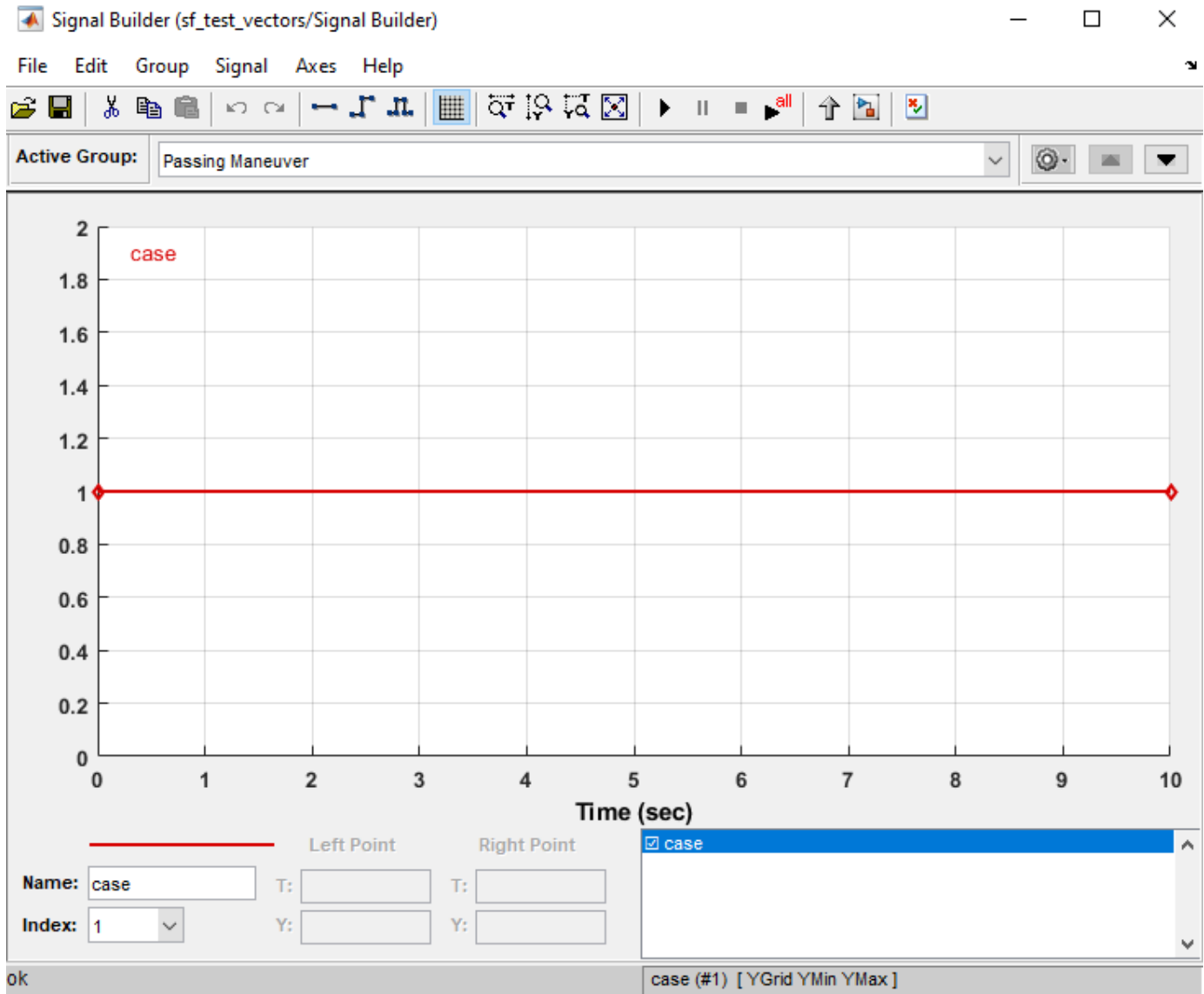

Select and Run Test Cases

In the Signal Builder, select and run test cases as follows:

To Test:	Do This:
One case	Click the tab that corresponds to the driving scenario you want to test and click the Start simulation button: <div style="text-align: center; margin-top: 10px;">  </div>

To Test:	Do This:
All cases and produce a model coverage report (requires a Simulink Coverage™ software license)	Click the Run all and produce coverage button:
	

The Signal Builder block sends to the Dynamic Test Vectors chart one or more constant signal values that correspond to the driving scenarios you select. The chart uses these values to activate the appropriate test cases.

Run the Model with Stateflow Test Vectors

- 1 Open the `sf_test_vectors` model.
- 2 Open the Dynamic Test Vectors chart, the Signal Builder block, and the Scope block.
- 3 Select and simulate a driving scenario from the Signal Builder block, as described in “Select and Run Test Cases” on page 27-24.

The scope shows the interaction between speed and throttle for the selected scenario.

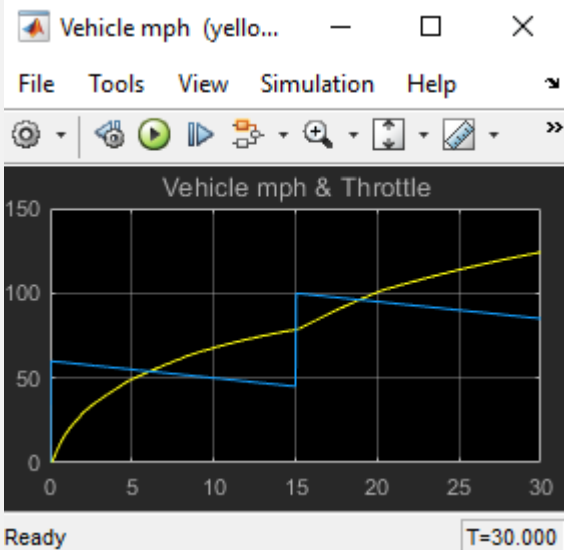
Driving Scenario	Scope Display	Description
Passing Maneuver	 <p>The scope display shows a graph titled "Vehicle mph & Throttle". The x-axis represents time in seconds from 0 to 30, and the y-axis represents speed in MPH from 0 to 150. A yellow line represents vehicle speed, starting at 0 and increasing to approximately 125 MPH at 30 seconds. A blue line represents throttle, starting at 50, dropping to 40 at 15 seconds, and then rising to 100 at 30 seconds. The plot is displayed in a window titled "Vehicle mph (yello..." with a menu bar (File, Tools, View, Simulation, Help) and a toolbar with various simulation controls. The status bar at the bottom indicates "Ready" and "T=30.000".</p>	Driver accelerates rapidly. At $t = 15$ seconds, steps the throttle to 100. With continued heavy throttle, the vehicle accelerates to about 100 MPH and then shifts into overdrive at about $t = 21$ seconds. The vehicle cruises along in fourth gear for the remainder of the simulation.

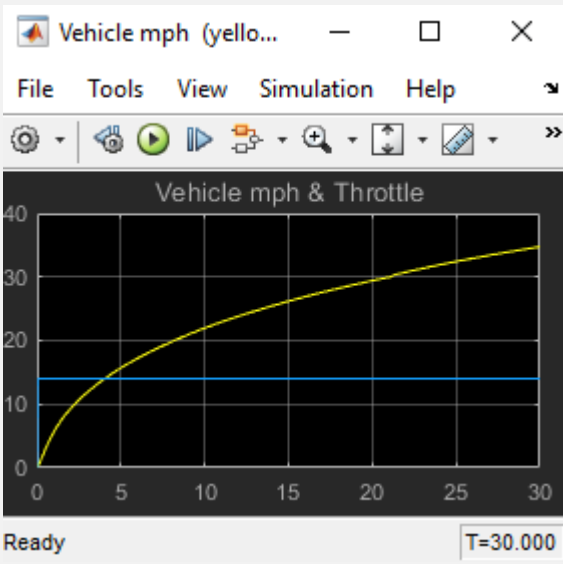
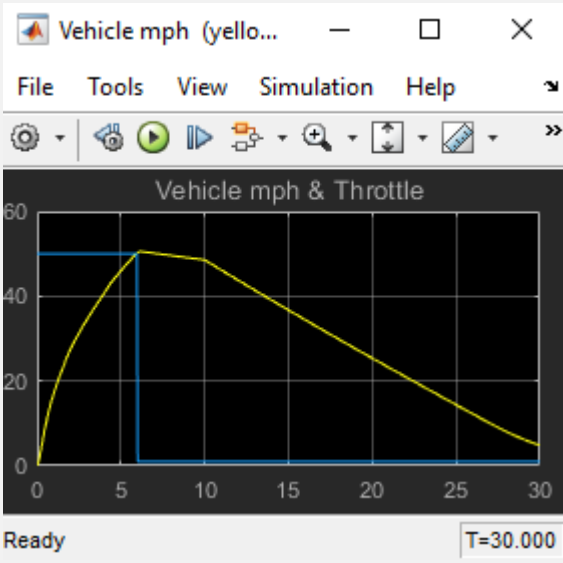
Driving Scenario	Scope Display	Description
Gradual Acceleration	 <p>The scope display shows a graph titled "Vehicle mph & Throttle". The y-axis represents speed in mph, ranging from 0 to 40. The x-axis represents time in seconds, ranging from 0 to 30. A blue horizontal line is drawn at approximately 15 mph. A yellow curve starts at (0,0) and rises smoothly, crossing the blue line at approximately 5 seconds and continuing to rise towards 40 mph at 30 seconds. The status bar at the bottom indicates "Ready" and "T=30.000".</p>	Driver maintains a slow but steady rate of acceleration.
Hard Braking	 <p>The scope display shows a graph titled "Vehicle mph & Throttle". The y-axis represents speed in mph, ranging from 0 to 60. The x-axis represents time in seconds, ranging from 0 to 30. A blue horizontal line is drawn at approximately 50 mph. A yellow curve starts at (0,0), rises to a peak of about 50 mph at 5 seconds, then drops sharply to 0 mph at approximately 6.5 seconds, and remains at 0 mph until 30 seconds. The status bar at the bottom indicates "Ready" and "T=30.000".</p>	Driver accelerates until the transmission shifts to third gear, then removes foot from the gas pedal. After a short delay, moves foot to the brake pedal and pushes hard.

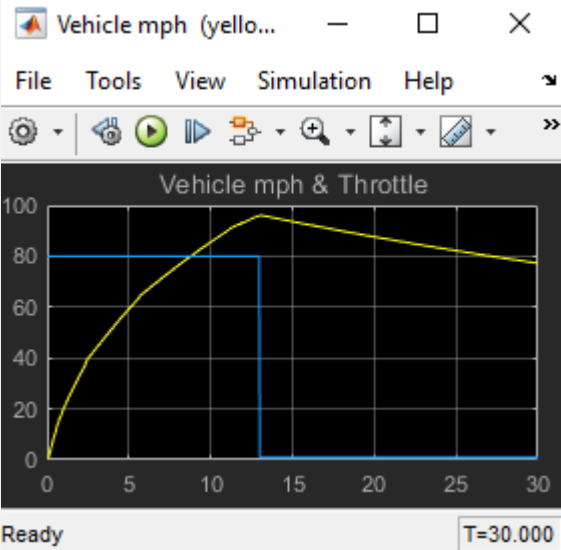
Driving Scenario	Scope Display	Description
Coasting		<p>Driver accelerates until transmission shifts to highest gear, then eases up on the gas.</p>

Map Fault Conditions to Actions by Using Truth Tables

You can use truth tables to map fault conditions of a system directly to their consequent actions. For example, the model `sf_aircraft` maps the fault conditions and actions using a truth table. For details on this model, see “Detect Faults in Aircraft Elevator Control System”.

Truth tables are only supported in Simulink. For more information, see “Use Truth Tables to Model Combinatorial Logic” on page 28-2.

Detect Faults in a System

Type `sf_aircraft` at the command line to open the example. In the Mode Logic chart, there are two truth tables, `R_switch` and `L_switch`, that describe the fault detection system for the aircraft elevator control system.

The fault detection system for the aircraft elevator control system has these requirements.

Condition	Action
Hydraulic pressure 1 failure	While there are no other failures, turn off the left outer actuator.
Hydraulic pressure 2 failure	While there are no other failures, turn off the left inner actuator and the right inner actuator.
Hydraulic pressure 3 failure	While there are no other failures, turn off the right outer actuator.
Actuator position failure	While there are no other failures, isolate that specific actuator.
Hydraulic pressure 1 and left outer actuator failures	While there are no other failures, turn off the left outer actuator
Hydraulic pressure 2 and left inner actuator failures	While there are no other failures, turn off the left inner actuator.
Hydraulic pressure 3 and right outer actuator failures	While there are no other failures, turn off the right outer actuator
Multiple failures on left hydraulics and actuators	Isolate the left outer actuator and the left inner actuator.
Multiple failures on right hydraulics and actuators	Isolate the right outer actuator and the right inner actuator.
Intermittent actuator failures	If an actuator has been switched on and off five times during operation, isolate that specific actuator.

The logic to satisfy these requirements is constructed using two truth tables in the chart `Mode Logic`; one for the right elevator (`R_switch`), and one for the left elevator (`L_switch`). This truth table is for the left elevator.

sf_aircraft ▶ Mode Logic ▶ L_switch

Condition Table

	DESCRIPTION	CONDITION	D1	D2	D3	D4	D5	D6	D7
1	Hydraulic system 1 Low pressure (Left Outer line)	u.low_press[0]	T	T	F	F	-	-	-
2	Left Outer actuator position failed	u.L_pos_fail[0]	-	-	T	T	-	-	-
3	Hydraulic system 2 Low pressure (Inner line)	u.low_press[1]	F	-	F	-	T	-	-
4	Left Inner actuator position failed	u.L_pos_fail[1]	F	-	F	-	-	T	-
		ACTIONS: SPECIFY A ROW FROM THE ACTION TABLE	2	3,5	3	3,5	4	5	Default

Action Table

	DESCRIPTION	ACTION
1	Default - All ok, do nothing.	Default:
2	Hydraulic System 1 Failure. Turn off Left Outer Actuator	<code>send(go_off,Actuators.LO);</code>
3	Left Outer Actuator Failure. Isolate Left Outer Actuator	<code>send(go_isolated,Actuators.LO);</code>
4	Hydraulic System 2 Failure. Turn off Left Inner Actuator	<code>send(go_off,Actuators.LI);</code>
5	Left Inner Actuator Failure. Isolate Left Inner Actuator	<code>send(go_isolated,Actuators.LI);</code>

The first requirement indicates that if a failure is only detected in the hydraulic pressure 1 system, turn off the left outer actuator. This requirement is represented in the decision **D1** in the truth table. If there is low pressure in the hydraulic system 1, then **D1** specifies that action 2 is performed. Action 2 sends an event `go_off` to the left actuator, `Actuators.LO`.

Similarly, the other requirements are mapped to the appropriate actions in the truth table. For example, if the left outer actuator fails, **D3** causes action 3. Action 3 sends the event `go_isolated` to `Actuators.LO` to isolate the left actuator.

The truth tables are called at entry(en) and during(du) actions for the chart so that fault checks execute at each time step.

See Also

duration

More About

- “Use Truth Tables to Model Combinatorial Logic” on page 28-2
- “Program a Truth Table” on page 28-6

Design for Isolation and Recovery in a Chart

Mode Logic for the Elevator Actuators

This example shows how the model `sf_aircraft` uses the chart `Mode Logic` to detect system faults and recover from failure modes for an aircraft elevator control system. For more information on this model, see “Detect Faults in Aircraft Elevator Control System”.

There are two elevators in the system, each with an outer and inner actuator. The `Actuators` state has a corresponding substate for each of the four actuators. An actuator has five modes: `Passive`, `Active`, `Standby`, `Off`, and `Isolated`. By default, the outer actuators are on, and the inner actuators are on standby. If a fault is detected in the outer actuators, the system responds to maintain stability by turning the outer actuators off and activating the inner actuators.

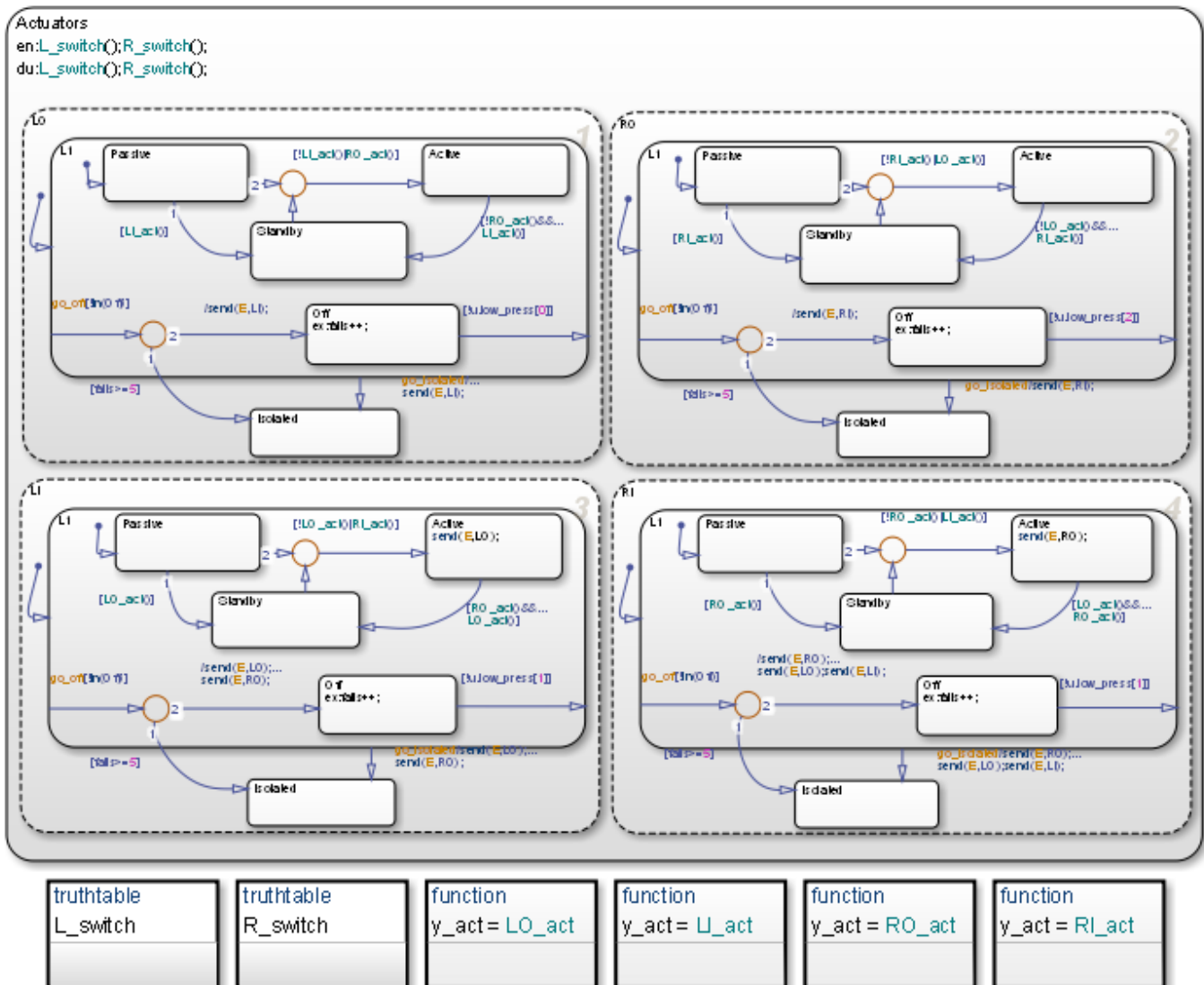

States for Failure and Isolation

Each actuator contains an *Off* state and an *Isolated* state. When the fault detection logic in one of the truth tables detects a failure, it broadcasts the event *go_off* or *go_isolated* to the failing actuator. For more information, see “Map Fault Conditions to Actions by Using Truth Tables” on page 27-28.

The *go_off* event instructs the failing actuator to transition to the *Off* state until the condition is resolved. The event *go_isolated* causes the failing actuator to transition to *Isolated*. Transitions to the *Isolated* state are from the superstate *L1*, which contains all the other operating modes. This state has no outgoing transitions, so that once an actuator has entered *Isolated* it remains there. Intermittent failures that cause an actuator to fail 5 or more times, also cause a transition to *Isolated*. The variable *fails* logs the number of failures for an actuator by incrementing each time a transition occurs out of *Off*.

Transitions for Recovery

Transitions in the substates for each actuator account for recovery requirements of the elevator system. These requirements derive from rules for symmetry and safety of the elevators such as:

- Only one actuator for an elevator must be active at one time.
- Outer actuators have priority over the inner actuators.
- Actuator activity should be symmetric if possible.
- Switching between actuators must be kept to a minimum.

For example, one requirement of the system is if one outer actuator fails, then the other outer actuator must move to standby and the inner actuators take over. Consequently, there is a transition from each *Active* state to *Standby*, and vice versa.

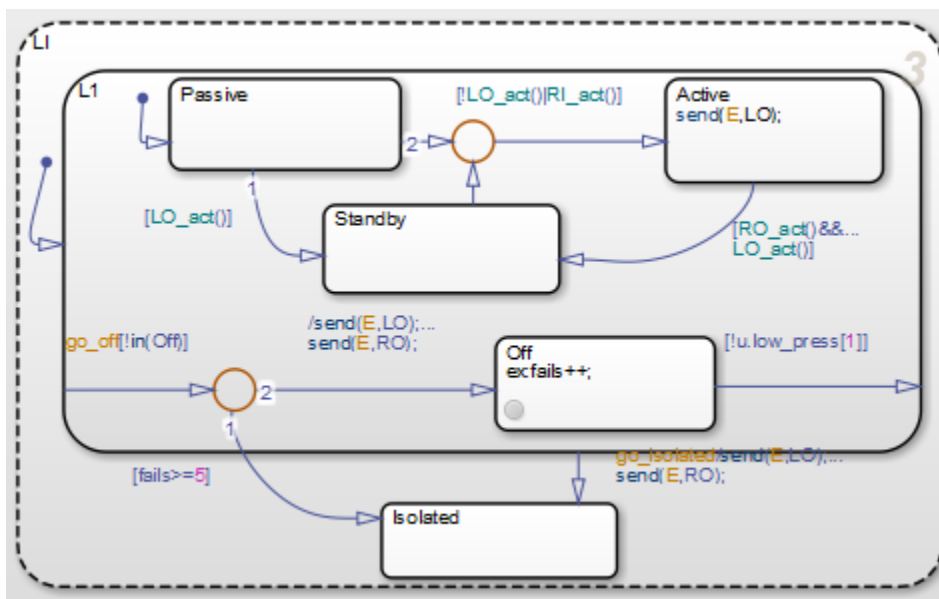

For the inner left actuator (LI), the transition to *Active* inside the *L1* superstate is conditionally based on `[!LO_act()|RI_act()]`. This causes the left inner actuator to turn on if the outer actuator (LO) has failed, or the right inner actuator (RI) has turned on.

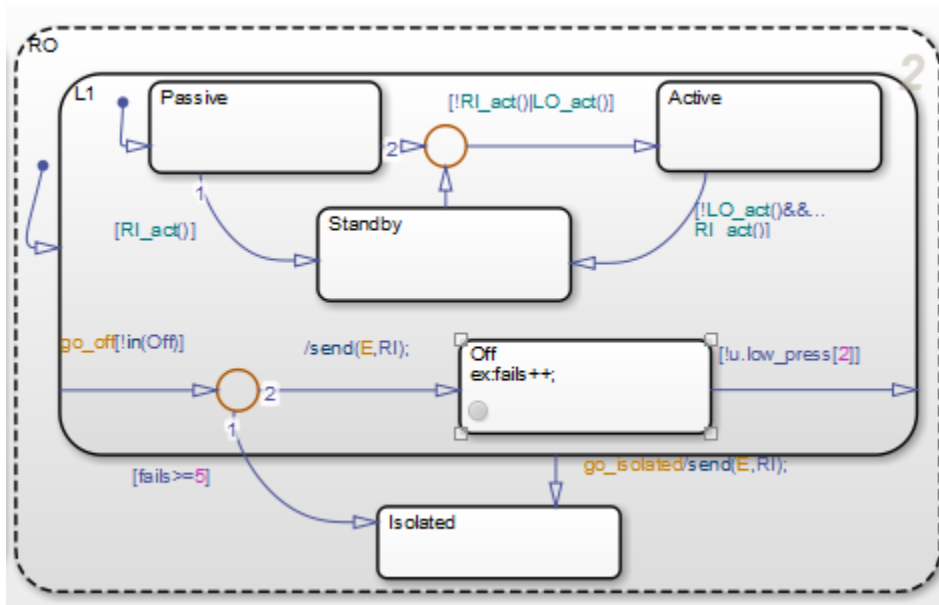

Another consequence if LO fails and moves out of Active is a transition that occurs in the right outer actuator (RO). The RO state transitions inside the L1 superstate from Active to Standby. This satisfies the requirement of the outer actuators and inner actuators to work in symmetry.

Truth Table Functions for Decision-Making Logic

- “Use Truth Tables to Model Combinatorial Logic” on page 28-2
- “Program a Truth Table” on page 28-6
- “Debug Errors in a Truth Table” on page 28-19
- “View Generated Content for Stateflow Truth Tables” on page 28-26
- “Correct Overspecified and Underspecified Truth Tables” on page 28-32

Use Truth Tables to Model Combinatorial Logic

Truth tables implement combinatorial logic design in a concise, tabular format. Typical applications for truth tables include decision making for:

- Fault detection and management
- Mode switching

Truth tables are supported only in Simulink.

You can add a Truth Table block directly to your Simulink model, or you can define a truth table function in a Stateflow chart, state, or subchart. Truth Table blocks in a Simulink model execute as a Simulink block, while truth table functions in a Stateflow chart execute only when you call the truth table function. The location of the function determines the set of states and transitions that can call the function.

- If you want to call the function anywhere in a chart, put your truth table function at the chart level.
- If you want to call the function from within one state or subchart and its substates, put your truth table function in that state or subchart. That function overrides any other functions of the same name in the parents and ancestors of that state or subchart.
- If you want to call the function from any chart in your model, put your truth table at the chart level and enable exporting of chart-level functions. For more information, see “Export Stateflow Functions for Reuse” on page 8-17.

Whether your truth table exists as a block within a Simulink model or as a function within a Stateflow chart, you program them the same way.

Layout of a Truth Table

This truth table function has the name `ttable`. It takes three arguments (`x`, `y`, and `z`) and returns one output value (`r`).

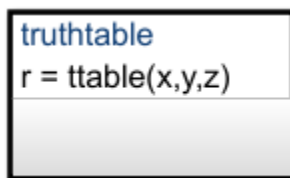

The function consists of this arrangement of conditions, decisions, and actions.

Condition	Decision 1	Decision 2	Decision 3	Decision 4
<code>x == 1</code>	T	F	F	-
<code>y == 1</code>	F	T	F	-
<code>z == 1</code>	F	F	T	-
Action	<code>r = 1</code>	<code>r = 2</code>	<code>r = 3</code>	<code>r = 4</code>

Each of the conditions entered in the **Condition** column must evaluate to true (nonzero value) or false (zero value). Outcomes for each condition are specified as T (true), F (false), or - (true or false).

Each of the decision columns combines an outcome for each condition with a logical AND into a compound condition, which is referred to as a decision.

You evaluate a truth table one decision at a time, starting with **Decision 1**. The **Decision 4** covers all possible remaining decisions. If one of the decisions is true, the table perform the associated action, and then the truth table execution is complete.

For example, if conditions $x == 1$ and $y == 1$ are false and condition $z == 1$ is true, then **Decision 3** is true and the variable r is set equal to 3. The remaining decisions are not tested and evaluation of the truth table is finished. If the first three decisions are false, then the default decision is automatically true and its action ($r=4$) is executed. This table lists pseudocode corresponding to the evaluation of this truth table example.

Pseudocode	Description
if ((x == 1) & !(y == 1) & !(z == 1)) r = 1;	If Decision 1 is true, then set r=1.
elseif (!(x == 1) & (y == 1) & !(z == 1)) r = 2;	If Decision 2 is true, then set r=2.
elseif (!(x == 1) & !(y == 1) & (z == 1)) r = 3;	If Decision 3 is true, then set r=3.
else r = 4; endif	If all other decisions are false, then default decision is true. Set r=4.

Define a Truth Table Function

To define a truth table function:

- 1 Declare the truth table function arguments and return values.
- 2 Program the truth table function. See “Program a Truth Table” on page 28-6.
- 3 Use the Property Inspector and Symbols pane to specify the data properties for each argument and return value.
- 4 Use the Symbols pane to create any additional data items required by your function. Your function can access its own data or data belonging to parent states or the chart.

Declare Function Arguments and Return Values

The function signature label specifies a name for your function and the formal names for its arguments and return values. A signature label has this syntax:

```
[return_val1,return_val2,...] = function_name(arg1,arg2,...)
```

You can specify multiple return values and multiple input arguments. Each return value and input argument can be a scalar, vector, or matrix of values. For functions with only one return value, omit the brackets in the signature label.

You can use the same variable name for both arguments and return values. For example, a function with this signature label uses the variables $y1$ and $y2$ as both inputs and outputs:

```
[y1,y2,y3] = f(y1,u,y2)
```

If you export this function to C code, `y1` and `y2` are passed by reference (as pointers), and `u` is passed by value. Passing inputs by reference reduces the number of times that the generated code copies intermediate data, resulting in more optimal code.

Call Truth Table Functions in States and Transitions

You can call truth table functions from the actions of any state or transition. You can also call truth table functions from other functions. If you export a truth table function, you can call it from any chart in the model. For more information about exporting functions, see “Export Stateflow Functions for Reuse” on page 8-17.

The syntax for a call to a truth table function is the same as the function signature, with actual arguments replacing the formal ones specified in a signature. If the data types of an actual and formal argument differ, a function casts the actual argument to the type of the formal argument.

If the formal arguments of a function signature are scalars, verify that inputs and outputs of function calls follow the rules of scalar expansion. For more information, see “Assign Values to All Elements of a Matrix” on page 18-6.

Specify Properties of Truth Table Functions

You can set general properties for your truth table function through its properties dialog box. To open the function properties dialog box, right-click the truth table function box and select **Properties** from the context menu.

Name

Function name. Click the function name link to bring your function to the foreground in its native chart.

Function Inline Option

Controls the inlining of your function in generated code:

- **Auto** — Determines whether to inline your function based on an internal calculation.
- **In line** — Inlines your function if you do not export it to other charts and it is not part of a recursion. (A recursion exists if your function calls itself directly or indirectly through another function call.)
- **Function** — Does not inline your function.

Label

Signature label for your function. For more information, see “Declare Function Arguments and Return Values” on page 28-3.

Underspecification

Controls the level of diagnostics for underspecification in your truth table function. For more information, see “Correct Overspecified and Underspecified Truth Tables” on page 28-32.

Overspecification

Controls the level of diagnostics for overspecification in your truth table function. For more information, see “Correct Overspecified and Underspecified Truth Tables” on page 28-32.

Action Language

Controls the action language for your Stateflow truth table function. Choose between MATLAB or C. For more information, see “Differences Between MATLAB and C as Action Language Syntax” on page 14-5.

Description

Function description. You can enter brief descriptions of functions in the hierarchy.

Document Link

Link to online documentation for the function. You can enter a web URL address or a MATLAB command that displays documentation in a suitable online format, such as an HTML file or text in the MATLAB Command Window. When you click the **Document link** hyperlink, Stateflow displays the documentation.

See Also**More About**

- “Program a Truth Table” on page 28-6
- “Differences Between MATLAB and C as Action Language Syntax” on page 14-5
- “Reusable Functions in Charts” on page 2-37
- “Export Stateflow Functions for Reuse” on page 8-17
- “Reuse Functions by Using Atomic Boxes” on page 8-28

Program a Truth Table

Once you've created a new truth table, you can program it to execute according to your specifications. To program a truth table you add conditions, decisions, and actions. For more information about creating a truth table, see “Use Truth Tables to Model Combinatorial Logic” on page 28-2.

Truth tables are supported only in Simulink models. For more information, see “Use Truth Tables to Model Combinatorial Logic” on page 28-2.

Open a Truth Table for Editing

After you create and label a truth table in a chart or Simulink model, you specify its logical behavior. These specifications apply to both the truth table block in a Simulink model and the truth table function in a Stateflow chart. In this example, you specify the behavior of a truth table function.

To open the truth table, double-click the truth table function, `ttable`, that you created in “Use Truth Tables to Model Combinatorial Logic” on page 28-2.

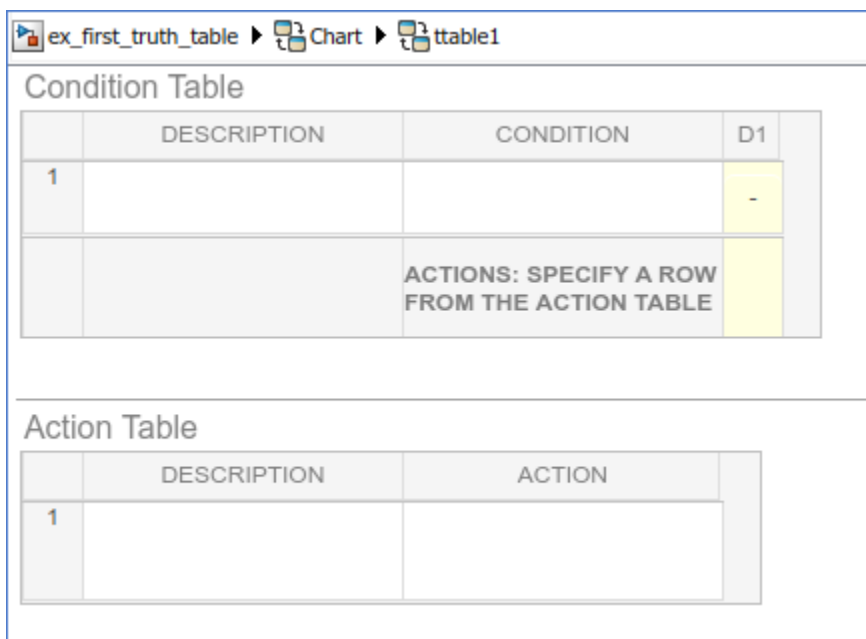

The screenshot shows the truth table editor interface. At the top, the breadcrumb path is "ex_first_truth_table > Chart > ttable1". Below this, there are two main sections: "Condition Table" and "Action Table".

The "Condition Table" section contains a table with the following structure:

	DESCRIPTION	CONDITION	D1
1			-
ACTIONS: SPECIFY A ROW FROM THE ACTION TABLE			

The "Action Table" section contains a table with the following structure:

	DESCRIPTION	ACTION
1		

By default, a truth table contains a **Condition Table** and an **Action Table**, each with one row. The **Condition Table** contains a single decision column, **D1**, and a single action row.

Select an Action Language

If the truth table is inside a Stateflow chart that uses C as the action language, you can specify the action language for your Stateflow truth table:

- 1 Open the Property Inspector. In the **Modeling** tab, under **Design Data**, select **Property Inspector**.
- 2 Under the **Properties** section, select **C** or **MATLAB** as the Action Language.

Truth tables inside a Stateflow chart that uses C as the action language must also use C as the action language.

Enter Truth Table Conditions

Conditions are the starting point for specifying logical behavior in a truth table. Open your new truth table, `ttable`, for editing. You start programming the behavior of `ttable` by specifying conditions.

You enter conditions in the **Condition** column of the **Condition Table**. For each condition that you enter, you can enter an optional description in the **Description** column. To enter conditions for the truth table `ttable`:

- 1 Click the row on the **Condition Table** that you want to append.

- 2 Click the **Append Row** button  on the side panel twice.

The truth table appends two rows to the bottom of the **Condition Table**.

- 3 Click and drag the bar that separates the **Condition Table** and the **Action Table** panes down to enlarge the **Condition Table** pane.

- 4 In the **Condition Table**, click the top cell of the **Description** column.

A flashing text cursor appears in the cell, which appears highlighted.

- 5 Enter this text:

```
x is equal to 1
```

Condition descriptions are optional, but appear as comments in the generated code for the truth table.

- 6 Click the next cell on the right, in the **Condition** column..

- 7 In the first cell of the **Condition** column, enter:

```
XEQ1:
```

This text is an optional label that you can include with the condition. Each label must begin with an alphabetic character (`[a-z]` `[A-Z]`) followed by any number of alphanumeric characters (`[a-z]` `[A-Z]` `[0-9]`) or an underscore (`_`).

- 8 Press **Enter** and this text:

```
x == 1
```

This text is the actual condition. Each condition that you enter must evaluate to zero (false) or nonzero (true). You can use optional brackets in the condition (for example, `[x == 1]`).

In truth table conditions, you can use data that passes to the truth table function through its arguments. The preceding condition tests whether the argument `x` is equal to 1. You can also use data defined for parent objects of the truth table, including the chart.

- 9 Repeat the preceding steps to enter the other two conditions.

ex_first_truth_table ▶ Chart ▶ ttable

Condition Table			
	DESCRIPTION	CONDITION	D1
1	x is equal to 1	XEQ1: x == 1	-
2	y is equal to 1	YEQ1: y == 1	-
3	z is equal to 1	ZEQ1: z == 1	-
ACTIONS: SPECIFY A ROW FROM THE ACTION TABLE			

Action Table	
	ACTION
1	

Enter Truth Table Decisions

Each decision column (**D1**, **D2**, and so on) binds a group of condition outcomes together with an AND relationship into a decision. The possible values for condition outcomes in a decision are T (true), F (false), and - (true or false). In “Enter Truth Table Conditions” on page 28-7, you entered conditions for the truth table `ttable`. Continue by entering values in the decision columns:

- 1 Click the decision column of the **Condition Table** that you want to append.
- 2 Click the **Append Column** button  on the side panel three times.
- 3 Click the top cell in decision column **D1**.
- 4 Press the space bar until a value of T appears.

Pressing the space bar toggles through the possible values of F, T, and -. You can also enter these characters directly. Pressing 1 sets the value to T, while pressing 0 sets the value to F. Pressing x sets the value to -.

- 5 Enter the remaining values for the decision columns:

Condition Table						
	DESCRIPTION	CONDITION	D1	D2	D3	D4
1	x is equal to 1	XEQ1: x == 1	T	F	F	-
2	y is equal to 1	YEQ1: y == 1	F	T	F	-
3	z is equal to 1	ZEQ1: z == 1	F	F	T	-
ACTIONS: SPECIFY A ROW FROM THE ACTION TABLE						

Action Table	
	ACTION
1	

During execution of the truth table, decision testing occurs in left-to-right order. The order of testing for individual condition outcomes within a decision is undefined. Truth tables evaluate the conditions for each decision in top-down order (first condition 1, then condition 2, and so on). Because this implementation is subject to change in the future, do not rely on a specific evaluation order.

The Default Decision Column

The last decision column in `ttable`, **D4**, is the default decision for this truth table. The default decision covers any decisions not tested for in preceding decision columns. Create a default decision by entering - in every cell of the farthest right decision column. This entry represents any outcome for the condition, T or F. The default decision column must be the last column on the right in the **Condition Table**.

Enter Truth Table Actions

During execution of the truth table, decision testing occurs in left-to-right order. When a decision match occurs, the action in the **Action Table** that is specified in the **Actions** row for that decision column executes. Then the truth table exits.

In “Enter Truth Table Decisions” on page 28-8, you entered decisions in the truth table. The next step is to enter actions you want to occur for each decision in the **Action Table**. Later, you assign these actions to their decisions in the **Actions** row of the **Condition Table**.

Set Up the Action Table

- 1 Click the row **Action Table** that you want to append.
- 2 Click the **Append Row** button  on the side panel three times.

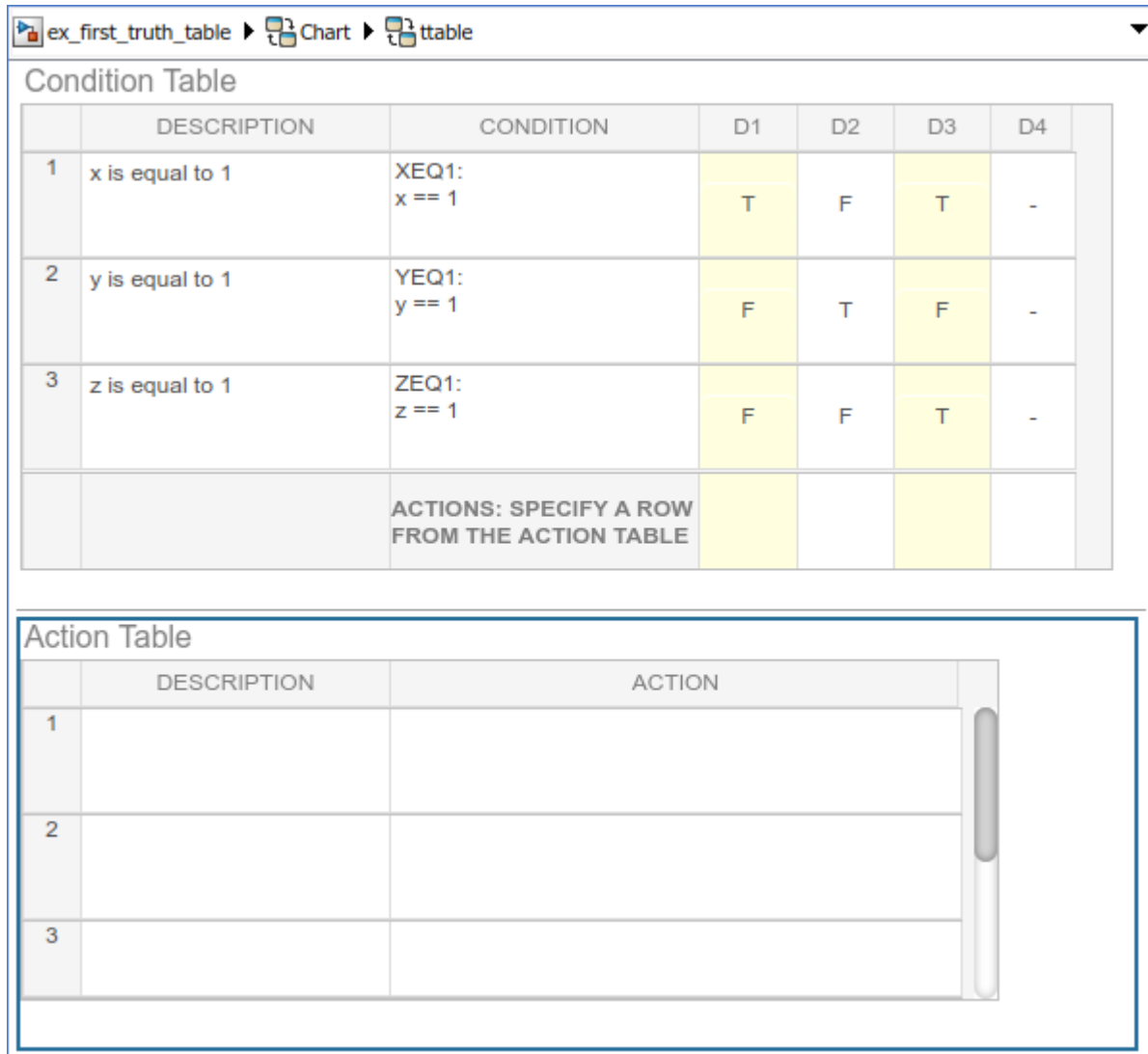

The screenshot shows a software interface with two tables. The top table is titled "Condition Table" and has columns for DESCRIPTION, CONDITION, D1, D2, D3, and D4. It contains three rows of conditions and a fourth row for actions. The bottom table is titled "Action Table" and has columns for DESCRIPTION and ACTION. It is currently empty.

Condition Table						
	DESCRIPTION	CONDITION	D1	D2	D3	D4
1	x is equal to 1	XEQ1: x == 1	T	F	T	-
2	y is equal to 1	YEQ1: y == 1	F	T	F	-
3	z is equal to 1	ZEQ1: z == 1	F	F	T	-
		ACTIONS: SPECIFY A ROW FROM THE ACTION TABLE				

Action Table	
	ACTION
1	
2	
3	

- 3 Program the actions for the truth table.

Program Actions of a Truth Table

For truth tables that use MATLAB as the action language, you can write MATLAB code to program your actions. Using this code, you can add control flow logic and call MATLAB functions directly. In the following procedure, you program an action in the truth table `ttable`, using the following features of MATLAB syntax:

- Persistent variables
- `if ... else ... end` control flows

- for loop

Follow these steps:

- 1 Click the top cell in the **Description** column of the **Action Table**.

A flashing text cursor appears in the cell, which appears highlighted.

- 2 Enter this description:

```
Maintain a counter and a circular
vector of values of length 6.
Every time this action is called,
output r takes the next value of
the vector.
```

Action descriptions are optional, but appear as comments in the generated code for the truth table.

- 3 Press the right arrow key to select the next cell on the right, in the **Action** column.
- 4 Enter the following text:

A1:

You begin an action with an optional label followed by a colon (:). Later, you enter these labels in the **Actions** row of the **Condition Table** to specify an action for each decision column. Like condition labels, action labels must begin with an alphabetic character ([a-z] [A-Z]) followed by any number of alphanumeric characters ([a-z] [A-Z] [0-9]) or an underscore (_).

- 5 Press **Enter** and enter the following text:

```
persistent values counter;
cycle = 6;

coder.extrinsic('plot');

if isempty(counter)
    % Initialize counter to be zero
    counter = 0;
else
    % Otherwise, increment counter
    counter = counter + 1;
end

if isempty(values)
    % Values is a vector of 1 to cycle
    values = zeros(1, cycle);
    for i = 1:cycle
        values(i) = i;
    end

    % For debugging purposes, call the MATLAB
    % function "plot" to show values
    plot(values);
end

% Output r takes the next value in values vector
r = values( mod(counter, cycle) + 1);
```

In truth table actions, you can use data that passes to the truth table function through its arguments and return value. The preceding action sets the return value `r` equal to the next value of the vector `values`. You can also specify actions with data defined for a parent object of the truth table, including the chart. Truth table actions can also broadcast or send events that are defined for the truth table, or for a parent, such as the chart itself.

- Enter the remaining actions in the **Action Table**, as shown:

The screenshot shows a software window titled 'ex_first_truth_table' with a breadcrumb path 'Chart > ttable'. It contains two tables:

Condition Table

	DESCRIPTION	CONDITION	D1	D2	D3	D4
1	x is equal to 1	XEQ1: x == 1	T	F	F	-
2	y is equal to 1	YEQ1: y == 1	F	T	F	-
3	z is equal to 1	ZEQ1: z == 1	F	F	T	-
ACTIONS: SPECIFY A ROW FROM THE ACTION TABLE						

Action Table

	DESCRIPTION	ACTION
1	Maintain a counter and a circular vector of values of length 6. Every time this	A1: persistent values counter; cycle = 6;
2	set r to 1	A2: r=1;
3	set r to 2	A3: r=2;
4	set r to 3	A4: r=3;

If action A1 executes during simulation, a plot of the `values` vector appears:

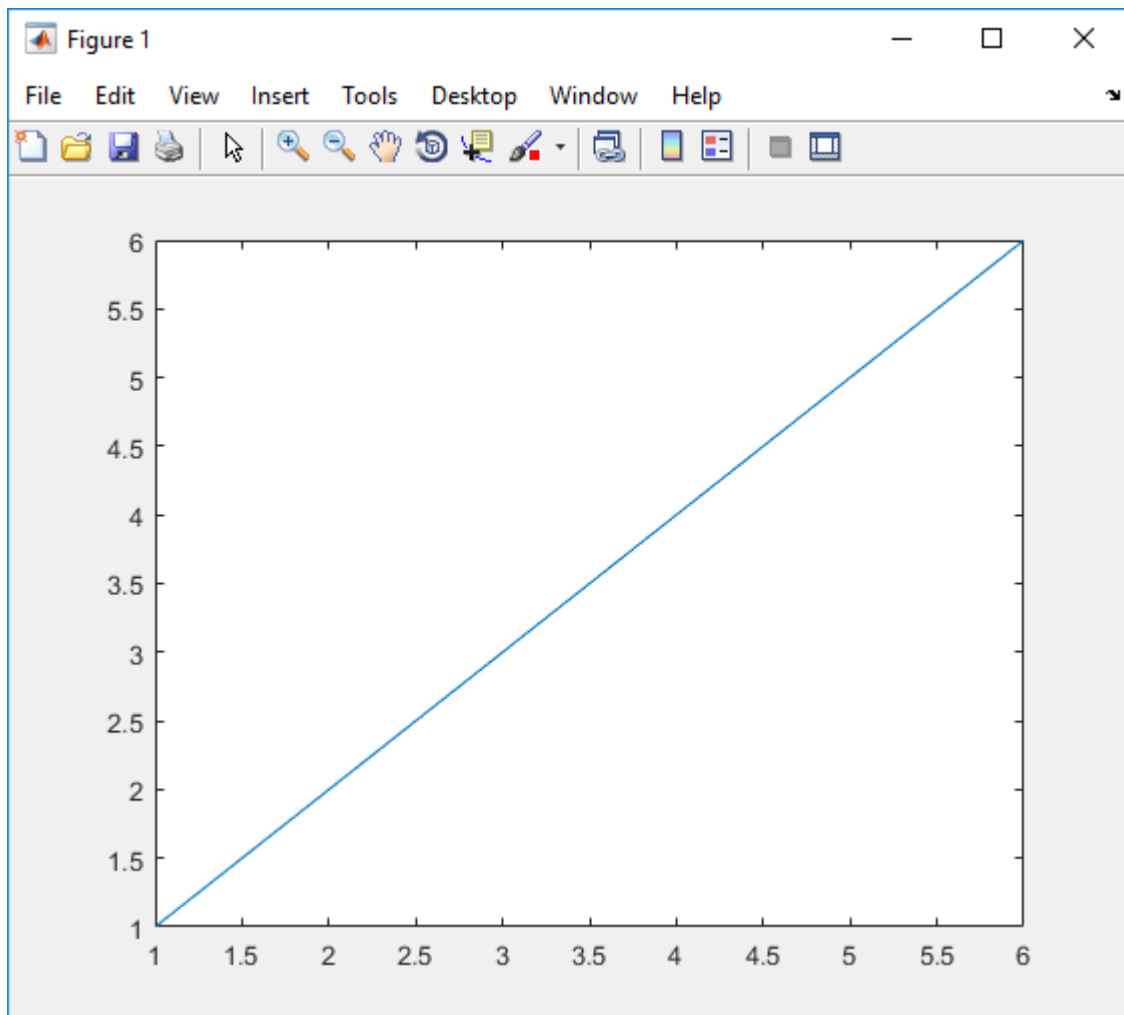

Now you are ready to assign actions to decision.

Assign Truth Table Actions to Decisions

You must assign at least one action from the **Action Table** to each decision in the **Condition Table**. The truth table uses this association to determine what action to execute when a decision tests as true.

Rules for Assigning Actions to Decisions

The following rules apply when you assign actions to decisions in a truth table:

- You specify actions for decisions by entering a row number or a label in the **Actions** row cell of a decision column.

If you use a label specifier, the label must appear with the action in the **Action Table**.

- You must specify at least one action for each decision.

Actions for decisions are not optional. Each decision must have at least one action specifier that points to an action in the **Action Table**. If you want to specify no action for a decision, specify a row that contains no action statements.

- You can specify multiple actions for a decision with multiple specifiers separated by a comma, semicolon, or space.

For example, for the decision column **D1**, you can specify **A1, A2, A3** or **1; 2; 3** to execute the first three actions when decision **D1** is true.

- You can mix row number and label action specifiers interchangeably in any order.

The following example uses both row and label action specifiers.

The screenshot shows a software window titled 'ex_first_truth_table' with tabs for 'Chart' and 'ttable'. The main content area is divided into two sections: 'Condition Table' and 'Action Table'.

Condition Table

	DESCRIPTION	CONDITION	D1	D2	D3	D4
1	x is equal to 1	XEQ1: x == 1	T	F	F	-
2	y is equal to 1	YEQ1: y == 1	F	T	F	-
3	z is equal to 1	ZEQ1: z == 1	F	F	T	-
ACTIONS: SPECIFY A ROW FROM THE ACTION TABLE			A1	2	A3	4

Action Table

	DESCRIPTION	ACTION
1	set r to 1	A1: r=1;
2	set r to 2	A2: r=2;
3	set r to 3	A3: r=3;
4	set r to 4	A4: r=4;

- You can specify the same action for more than one decision, as shown:

The screenshot shows a software window titled 'ex_first_truth_table' with a 'Chart' tab and a 'ttable' tab. The 'ttable' tab contains two tables:

Condition Table

	DESCRIPTION	CONDITION	D1	D2	D3	D4
1	x is equal to 1	XEQ1: x == 1	T	F	F	-
2	y is equal to 1	YEQ1: y == 1	F	T	F	-
3	z is equal to 1	ZEQ1: z == 1	F	F	T	-
ACTIONS: SPECIFY A ROW FROM THE ACTION TABLE			A1	1	A2	2

Action Table

	DESCRIPTION	ACTION
1	set r to 1	A1: r=1;
2	set r to 2	A2: r=2;

- Row number action specifiers in the **Actions** row of the **Condition Table** automatically adjust to changes in the row order of the **Action Table**.

How to Assign Actions to Decisions

This section describes how to assign actions to decisions in the truth table `ttable`. In this example, the **Actions** row cell for each decision column contains a label specified for each action in the **Action Table**. Follow these steps:

- 1 Click the bottom cell in decision column **D1**, the first cell of the **Actions** row of the **Condition Table**.
- 2 Enter the action specifier **A1** for decision column **D1**.

When **D1** is true, action **A1** in the **Action Table** executes.

- 3 Enter the action specifiers for the remaining decision columns:

ex_first_truth_table | Chart | ttable

Condition Table

	DESCRIPTION	CONDITION	D1	D2	D3	D4
1	x is equal to 1	XEQ1: x == 1	T	F	F	-
2	y is equal to 1	YEQ1: y == 1	F	T	F	-
3	z is equal to 1	ZEQ1: z == 1	F	F	T	-
		ACTIONS: SPECIFY A ROW FROM THE ACTION TABLE	A1	A2	A3	A4

Action Table

	DESCRIPTION	ACTION
1	set r to 1	A1: r=1;
2	set r to 2	A2: r=2;
3	set r to 3	A3: r=3;
4	set r to 4	A4: r=4;

Now you are ready to perform the final step in programming a truth table.

Add Initial and Final Actions

In addition to actions for decisions, you can add initial and final actions to the truth table function. Initial actions specify an action that executes before any decision testing occurs. Final actions specify an action that executes as the last action before the truth table exits. To specify initial and final actions for a truth table, use the action labels **INIT** and **FINAL** in the **Action Table**.

Use this procedure to add initial and final actions that display diagnostic messages in the MATLAB Command Window before and after execution of the truth table `ttable`:

- 1 In the truth table, right-click row 1 of the **Action Table** and select **Insert Row**.

A blank row appears at the top of the **Action Table**.

- 2 In the **Modeling** tab, select **Append Row**.

A blank row appears at the bottom of the **Action Table**.

- 3 Click and drag the bottom border of the truth table to show all six rows of the **Action Table**:

ex_first_truth_table ▶ Chart ▶ ttable

Condition Table

	DESCRIPTION	CONDITION	D1	D2	D3	D4
1	x is equal to 1	XEQ1: x == 1	T	F	F	-
2	y is equal to 1	YEQ1: y == 1	F	T	F	-
3	z is equal to 1	ZEQ1: z == 1	F	F	T	-
		ACTIONS: SPECIFY A ROW FROM THE ACTION TABLE	A1	A2	A3	A4

Action Table

	DESCRIPTION	ACTION
1		
2	set r to 1	A1: r=1;
3	set r to 2	A2: r=2;
4	set r to 3	A3: r=3;
5	set r to 4	A4: r=4;
6		

- 4 Add the initial action in row 1 as follows:

Description	Action
Initial action:	INIT:
Display message	<code>coder.extrinsic('disp');</code> <code>disp('truth table ttable entered');</code>

- 5 Add the final action in row 6 as follows:

Description	Action
Final action:	FINAL:
Display message	<code>coder.extrinsic('disp');</code> <code>disp('truth table ttable exited');</code>

Although the initial and final actions for the preceding truth table example appear in the first and last rows of the **Action Table**, you can enter these actions in any row. You can also assign initial and final actions to decisions by using the action specifier INIT or FINAL in the **Actions** row of the **Condition Table**.

Generate Content for Truth Tables

When you have simulated your model, Stateflow generates content for your truth table. To see the generated content, click the View Generated Content  button. For truth tables that use C as the action language, content is generated as a graphical function. For truth tables that use MATLAB as the action language, content is generated as MATLAB code. For more information, see “View Generated Content for Stateflow Truth Tables” on page 28-26.

See Also

More About

- “Use Truth Tables to Model Combinatorial Logic” on page 28-2
- “Export Stateflow Functions for Reuse” on page 8-17

Debug Errors in a Truth Table

Once you completely specify your truth tables, you begin the process of debugging them. The first step is to run diagnostics to check truth tables for syntax errors including overspecification and underspecification, as described in “Correct Overspecified and Underspecified Truth Tables” on page 28-32. Additionally, you can add breakpoints directly into your truth table to debug during simulation.

Truth tables are supported only in Simulink. For more information, see “Use Truth Tables to Model Combinatorial Logic” on page 28-2.

Find Syntax Errors by Running Diagnostics

To check for syntax errors:

- 1 Double-click the truth table.
- 2 In the truth table, click **Run Diagnostics** .

For example, if you change the action for decision column **D4** to an action that does not exist, you get an error message in the Diagnostic Viewer.

Truth table diagnostics run automatically when you simulate a model with a new or modified truth table. If no errors exist, the diagnostic window does not appear and simulation starts immediately.



Debug Logic by Using Breakpoints





You can use breakpoints in a Stateflow truth table to pause simulation and debug your logic. Once a breakpoint causes the simulation to pause, you can step through the actions and examine the data values at that specific point in the simulation.

With truth tables, you can set these different breakpoint types:

- Condition tested
- Decision tested
- Decision valid
- Action executed

After simulation stops at a breakpoint, you can continue chart execution on the Stateflow Editor toolbar, at the MATLAB command prompt, or by selecting a keyboard shortcut.

Toolbar Icon	Option	Command	Description	Keyboard Shortcut
	Continue	dbcont	Continue the simulation to the next breakpoint.	Ctrl+T
	Step Over	dbstep	Advance to the next step in the truth table execution.	F10

Toolbar Icon	Option	Command	Description	Keyboard Shortcut
	Step In	dbstep in	From a state or transition action that calls a function, advance to the first executable statement in the function. From a statement in a function containing another function call, advance to the first executable statement in the second function. Otherwise, advance to the next step in the truth table execution. (See Step Over.)	F11
	Step Out	dbstep out	From a function call, return to the statement calling the function. Otherwise, continue simulation to the next breakpoint. (See Continue.)	Shift+F11
	Step Forward		Exit debug mode and pause simulation before next time step.	
	Stop	dbquit	Exit debug mode and stop simulation.	Ctrl+Shift+T

Condition Breakpoints

To set a breakpoint when a condition is tested, right-click the condition cell and select **Set Breakpoint (Condition Tested)**. A red badge appears on the far left of the table next to the number of the condition. When you run the model, the simulation pauses when the condition is tested. Stateflow highlights the condition row being tested. Place your cursor over the data in the truth table to see its current value.

ex_first_truth_table ▶ Chart ▶ ttable

Condition Table

	DESCRIPTION	CONDITION	D1	D2	D3	D4
1	x is equal to 1	XEQ1: x == 1	T	F	F	-
2	y is equal to 1	YEQ1: y == 1	F	T	F	-
3	z is equal to 1	ZEQ1: z == 1	F	F	T	-
		ACTIONS: SPECIFY A ROW FROM THE ACTION TABLE	A1	A2	A3	A4

Action Table

	DESCRIPTION	ACTION
1	Initial action: Display message	INIT: ml.disp('truth table ttable entered');
2	set t to 1	A1: t=1;
3	set t to 2	A2: t=2;
4	set t to 3	A3: t=3;
5	set t to 4	A4: t=4;
6	Final action: Display message	FINAL: ml.disp('truth table ttable exited');

Decision Breakpoints

To set a breakpoint when a decision is tested, right-click the top of the decision column and select **Set Breakpoint (Decision Tested)**. A red badge appears on the top of the decision column next to the number of the decision. When you run the model, the simulation pauses when the decision is tested. Stateflow highlights the decision column being tested. Place your cursor over the data in the truth table to see its current value.

ex_first_truth_table ▶ Chart ▶ ttable

Condition Table

	DESCRIPTION	CONDITION	D1 	D2	D3	D4
1	x is equal to 1	XEQ1: x == 1	T	F	F	-
2	y is equal to 1	YEQ1: y == 1	F	T	F	-
3	z is equal to 1	ZEQ1: z == 1	F	F	T	-
		ACTIONS: SPECIFY A ROW FROM THE ACTION TABLE	A1	A2	A3	A4

Action Table

	DESCRIPTION	ACTION
1	Initial action: Display message	INIT: ml.disp('truth table ttable entered');
2	set t to 1	A1: t=1;
3	set t to 2	A2: t=2;
4	set t to 3	A3: t=3;
5	set t to 4	A4: t=4;
6	Final action: Display message	FINAL: ml.disp('truth table ttable exited');

To set a breakpoint when a decision is valid, right-click the action cell at the bottom of the decision column and select **Set Breakpoint (Decision Valid)**. A red badge appears on the top of the cell next to the action number. When you run the model, the simulation pauses when the action is valid. Stateflow highlights the valid decision. Place your cursor over the data in the truth table to see its current value.

If there is more than one action to take when a decision is valid, the breakpoint is set for the first executable. In truth tables that use MATLAB as the action language, you can set a breakpoint on any line of executable code by setting breakpoints in the generated content. See “Debugging Generated Truth Table Content” on page 28-25.

ex_first_truth_table ▶ Chart ▶ ttable

Condition Table

	DESCRIPTION	CONDITION	D1	D2	D3	D4
1	x is equal to 1	XEQ1: x == 1	T	F	F	-
2	y is equal to 1	YEQ1: y == 1	F	T	F	-
3	z is equal to 1	ZEQ1: z == 1	F	F	T	-
		ACTIONS: SPECIFY A ROW FROM THE ACTION TABLE	A1	A2	A3	A4

Action Table

	DESCRIPTION	ACTION
1	Initial action: Display message	INIT: ml disp('truth table ttable entered');
2	set t to 1	A1: t=1;
3	set t to 2	A2: t=2;
4	set t to 3	A3: t=3;
5	set t to 4	A4: t=4;
6	Final action: Display message	FINAL: ml disp('truth table ttable exited');

Action Breakpoints

To set a breakpoint when an action is executed, right-click the action cell and select **Set Breakpoint (Action Executed)**. A red badge appears on the far left of the table next to the number of the action. When you run the model, the simulation pauses when the action is executed. Stateflow highlights the action row being tested. Place your cursor over the data in the truth table to see its current value.

If there is more than one action within the action cell, the breakpoint is set for the first action. In truth tables that use MATLAB as the action language, you can set a breakpoint on any line of

executable code by setting breakpoints in the generated content. See “Debugging Generated Truth Table Content” on page 28-25.

ex_first_truth_table ▶ Chart ▶ ttable

Condition Table

	DESCRIPTION	CONDITION	D1	D2	D3	D4
1	x is equal to 1	XEQ1: x == 1	T	F	F	-
2	y is equal to 1	YEQ1: y == 1	F	T	F	-
3	z is equal to 1	ZEQ1: z == 1	F	F	T	-
		ACTIONS: SPECIFY A ROW FROM THE ACTION TABLE	A1	A2	A3	A4

Action Table

	DESCRIPTION	ACTION
1	Initial action: Display message	INIT: ml.disp("truth table ttable entered");
2	set t to 1	A1: t=1;
3	set t to 2	A2: t=2;
4	set t to 3	A3: t=3;
5	set t to 4	A4: t=4;
6	Final action: Display message	FINAL: ml.disp("truth table ttable exited");

Edit Breakpoints

Click the breakpoint to open the **Edit Breakpoint** dialog box. From this window you can disable the breakpoint by clearing the **Enable Breakpoint** check box.

When you add a condition to a breakpoint, the breakpoint pauses the simulation only when its associated condition is true.

Debugging Generated Truth Table Content

You can use breakpoints on the generated content for truth tables that use MATLAB or C as the action language.

For truth tables that use MATLAB as the action language, content is generated as MATLAB code. To set a breakpoint in the code, click the breakpoint alley next to the executable line where you want simulation to pause. See “Debug a MATLAB Program” (MATLAB). When you add an element to your truth table that changes the generated content, all breakpoints are regenerated.

For truth tables that use C as the action language, content is generated as a graphical function. To set a breakpoint in the graphical function, right-click the transition where you want to set a breakpoint and select **Set Breakpoint**. When you add an element to your truth table that changes the generated content, all breakpoints are regenerated if you recompile your truth table.

See Also

More About

- “Use Truth Tables to Model Combinatorial Logic” on page 28-2
- “Program a Truth Table” on page 28-6
- “Correct Overspecified and Underspecified Truth Tables” on page 28-32
- “Debugging a MATLAB Function Block” (Simulink)

View Generated Content for Stateflow Truth Tables

You generate content for a truth table when you simulate your model. Content regenerates whenever a truth table changes. To view the generated content of a truth table, click the **View Generated**

Content button . Stateflow charts that use C as the action language generate content as a graphical function. Stateflow charts that use MATLAB as the action language generate content as MATLAB code.

How Stateflow Software Generates Graphical Functions for Truth Tables

This section describes how Stateflow software translates the logic of a C truth table into a graphical function.

In the following example, a C truth table has three conditions, four decisions and actions, and initial and final actions.

ex_truhtable_view_generated_content ▶ Chart ▶ xyz

Condition Table

	DESCRIPTION	CONDITION	D1	D2	D3	D4
1	Condition C1	C1: x == 0	T	F	F	-
2	Condition C2	C2: y == 0	-	T	F	-
3	Condition C3	C3: z == 0	-	-	T	-
ACTIONS: SPECIFY A ROW FROM THE ACTION TABLE			A1	A2	A3	DA

Action Table

	DESCRIPTION	ACTION
1	Initial Action	INIT: ml.disp('beginning truth table');
2	Action 1	A1: x = 1;
3	Action 2	A2: y = 1;
4	Action 3	A3: z = 1;
5	Default Action	DA: x = 0; y = 0; z = 0;
6	Final Action	FINAL: ml.disp('ending truth table');

Stateflow software generates a graphical function for the preceding truth table. The top half of the flow chart looks like this:

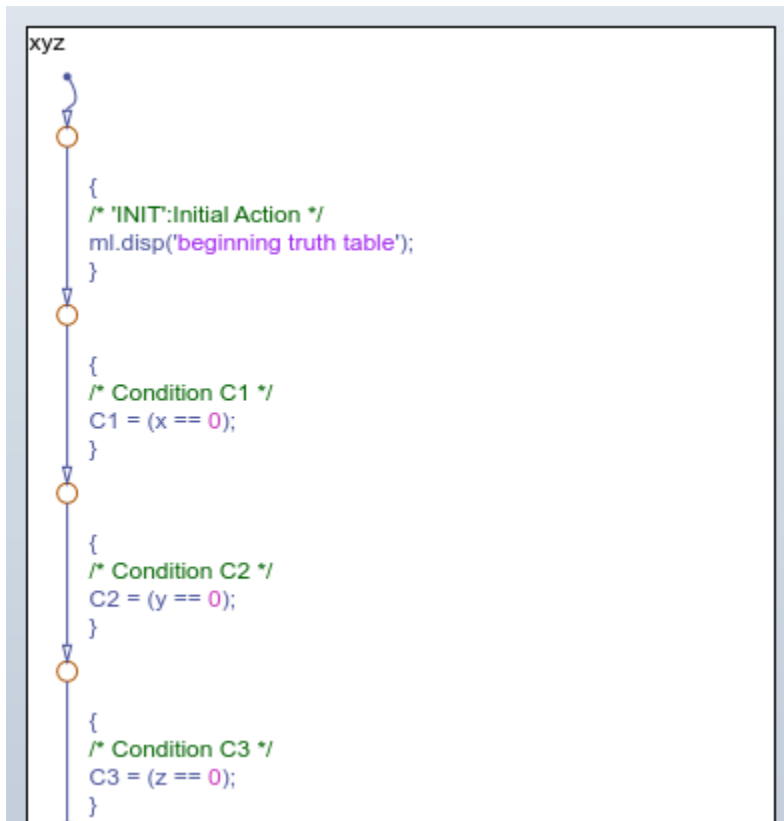

The top half of the flow chart executes as follows:

- Performs initial actions
- Evaluates the conditions and stores the results in temporary data variables

The temporary data for storing conditions is based on the labels that you enter for the conditions. If you do not specify the labels, temporary data variables appear.

The bottom half of the flow chart looks like this:

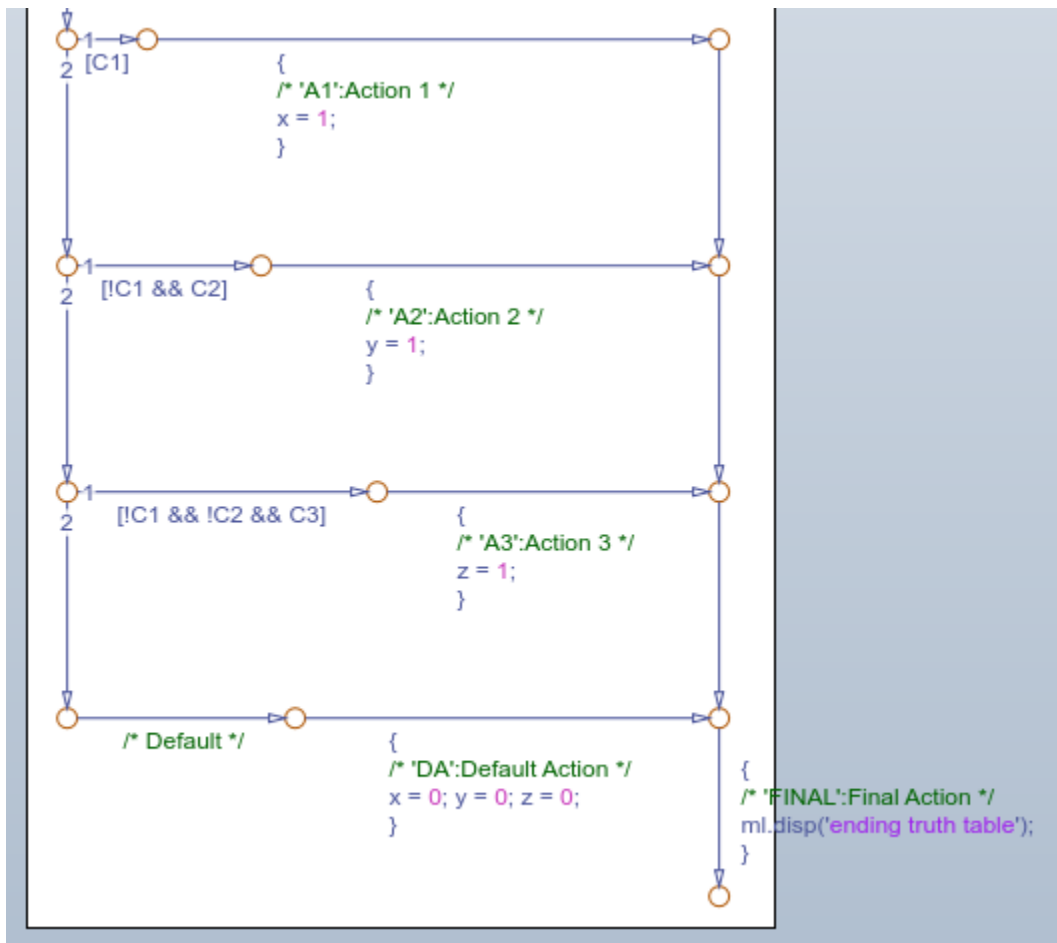

In the bottom half of the flow chart, the stored values for conditions determine which decision is true and what action to perform. Each decision appears as a fork from a connective junction with one of two possible paths:

- A transition segment with a decision followed by a segment with the consequent action

The action appears as a condition action that leads to the **FINAL** action and termination of the flow chart.

- A transition segment that flows to the next fork for an evaluation of the next decision

This transition segment has no condition or action.

This implementation continues from the first decision through the remaining decisions in left-to-right column order. When a decision match occurs, the action for that decision executes as a condition action of its transition segment. After the action executes, the flow chart performs the final action for the truth table and terminates. Therefore, only one action results from a call to a truth table graphical function. This behavior also means that no data dependencies are possible between different decisions.

How Stateflow Software Generates MATLAB Code for Truth Tables

Stateflow software generates the content of MATLAB truth tables as MATLAB code that represents each action as a *nested* function inside the main truth table function.

Nested functions offer these advantages:

- Nested functions are independent of one another. Variables are local to each function and not subject to naming conflicts.
- Nested functions can access all data from the main truth table function.

The generated content appears in the function editor, which provides tools for simulation and debugging.

Here is the generated content for the MATLAB truth table described in “Program Actions of a Truth Table” on page 28-10:

- Main truth table function

```
function r = ttable(x,y,z)

% Initialize condition vars to logical scalar
XEQ1 = false;
YEQ1 = false;
ZEQ1 = false;

% Condition #1, "XEQ1"
% x is equal to 1
XEQ1 = logical(x == 1);

% Condition #2, "YEQ1"
% y is equal to 1
YEQ1 = logical(y == 1);

% Condition #3, "ZEQ1"
% z is equal to 1
ZEQ1 = logical(z == 1);

if (XEQ1 && ~YEQ1 && ~ZEQ1) % D1
    A1();
elseif (~XEQ1 && YEQ1 && ~ZEQ1) % D2
    A2();
elseif (~XEQ1 && ~YEQ1 && ZEQ1) % D3
    A3();
else % Default
    A4();
end
```

- Action A1

```
function A1()
% Action #1, "A1"
% Maintain a counter and a circular vector of length 6.
% Every time this action is called,
% output t takes the next value of the vector.

persistent values counter;
```

```

cycle = 6;

if isempty(counter)
    % Initialize counter to be zero
    counter = 0;
else
    % Otherwise, increment counter
    counter = counter + 1;
end

if isempty(values)
    % Values is a vector of 1 to cycle
    values = zeros(1, cycle);
    for i = 1:cycle
        values(i) = i;
    end

    % For debugging purposes, call the MATLAB
    % function "plot" to show values
    plot(values);
end

% Output r takes the next value in values vector
r = values( mod(counter, cycle) + 1);

```

- Actions A2, A3, and A4

```

function A2()
% Action #2, "A2"
% set r to 2

r=2;

%=====
function A3()
% Action #3, "A3"
% set r to 3

r=3;

%=====
function A4()
% Action #4, "A4"
% set r to 4

r=4;

```

See Also

More About

- “Use Truth Tables to Model Combinatorial Logic” on page 28-2
- “Program a Truth Table” on page 28-6

Correct Overspecified and Underspecified Truth Tables

When programming your truth table, you might program an overspecified or underspecified truth table. An overspecified truth table contains at least one true or false combination that is specified by another decision column. When this happens, the action associated with that decision column never executes. An underspecified truth table occurs when your truth table does not have enough decision columns to account for all possible true or false combinations.

By default, Stateflow reports an error for overspecified and underspecified truth tables. To adjust the error settings for truth tables, open your truth table. After opening the truth table, in the **Modeling** tab, click **Table Properties** and change the settings for **Underspecification** or **Overspecification**.

Truth tables are supported only in a Simulink model. For more information, see “Use Truth Tables to Model Combinatorial Logic” on page 28-2.

Example of an Overspecified Truth Table

An overspecified truth table contains at least one decision that never executes because a previous decision specifies it in the **Condition Table**. The following example shows the **Condition Table** of an overspecified truth table.

Condition Table						
	DESCRIPTION	CONDITION	D1	D2	D3	
1	Condition C1	C1: x == 0	F	T	-	
2	Condition C2	C2: y == 0	T	-	T	
3	Condition C3	C3: z == 0	T	T	T	
		ACTIONS: SPECIFY A ROW FROM THE ACTION TABLE	A1	A2	A3	

The decision in column **D3** (-TT) specifies the decisions FTT and TTT. These decisions are duplicates of decisions **D1** (FTT) and **D2** (TTT and TFT). Therefore, column **D3** is an overspecification.

The following example shows the **Condition Table** of a truth table that appears to be overspecified, but is not.

ex_truthtable_not_overspecified ▶ Chart ▶ xyz

Condition Table						
	DESCRIPTION	CONDITION	D1	D2	D3	D4
1	Condition C1	C1: x == 0	F	T	T	-
2	Condition C2	C2: y == 0	T	F	T	T
3	Condition C3	C3: z == 0	T	T	F	T
ACTIONS: SPECIFY A ROW FROM THE ACTION TABLE			A1	A2	A3	A4

In this case, the decision **D4** specifies two decisions (TTT and FTT). FTT also appears in decision **D1**, but TTT is not a duplicate. Therefore, this **Condition Table** is not overspecified.

Example of an Underspecified Truth Table

An underspecified truth table includes undefined behavior because it lacks decisions that cover every combination of the specified conditions.. The following example shows the **Condition Table** of an underspecified truth table.

ex_truthtable_underspecified ▶ Chart ▶ xyz

Condition Table					
	DESCRIPTION	CONDITION	D1	D2	D3
1	Condition C1	C1: x == 0	T	T	F
2	Condition C2	C2: y == 0	T	F	T
3	Condition C3	C3: z == 0	F	T	T
ACTIONS: SPECIFY A ROW FROM THE ACTION TABLE			A1	A2	A3

Complete coverage of the conditions in the preceding truth table requires a **Condition Table** with every possible decision:

ex_truthtable_completely_specified ▶ Chart ▶ xyz

Condition Table			D1	D2	D3	D4	D5	D6	D7	D8
1	Condition C1	C1: x == 0	T	T	F	T	F	T	F	F
2	Condition C2	C2: y == 0	T	F	T	T	F	F	T	F
3	Condition C3	C3: z == 0	F	T	T	T	F	F	F	T
		ACTIONS: SPECIFY A ROW FROM THE ACTION TABLE	A1	A2	A3	A4	A5	A6	A7	A8

To avoid underspecification specify an action for all other possible decisions through a default decision, named DA:

ex_truthtable_default_action ▶ Chart ▶ xyz

Condition Table			D1	D2	D3	D4
1	Condition C1	C1: x == 0	T	T	F	-
2	Condition C2	C2: y == 0	T	F	T	-
3	Condition C3	C3: z == 0	F	T	T	-
		ACTIONS: SPECIFY A ROW FROM THE ACTION TABLE	A1	A2	A3	DA

The last decision column, **D4**, is the default decision for the truth table. The default decision covers any remaining decisions not tested in the preceding decision columns. See “The Default Decision Column” on page 28-9 for an example and more complete description of the default decision column for a **Condition Table**.

See Also

More About

- “Use Truth Tables to Model Combinatorial Logic” on page 28-2
- “Program a Truth Table” on page 28-6
- “Debug Errors in a Truth Table” on page 28-19

MATLAB Functions in Stateflow Charts

- “Reuse MATLAB Code by Defining MATLAB Functions” on page 29-2
- “Program a MATLAB Function in a Chart” on page 29-6
- “Connect Structures in MATLAB Functions to Simulink Bus Signals” on page 29-12
- “Debug a MATLAB Function in a Chart” on page 29-14

Reuse MATLAB Code by Defining MATLAB Functions

A MATLAB function in a Stateflow chart is a graphical element that you use to write algorithms that are easier to implement by calling built-in MATLAB functions. Typical applications include:

- Matrix-oriented calculations
- Data analysis and visualization

This type of function is useful for coding algorithms that are more easily expressed by using MATLAB instead of the graphical Stateflow constructs. MATLAB functions also provide optimizations for generating efficient, production-quality C code for embedded applications.

A MATLAB function can reside anywhere in a chart, state, or subchart. The location of the function determines the set of states and transitions that can call the function.

- If you want to call the function only within one state or subchart and its substates, put your MATLAB function in that state or subchart. That function overrides any other functions of the same name in the parents and ancestors of that state or subchart.
- If you want to call the function anywhere in that chart, put your MATLAB function at the chart level.
- If you want to call the function from any chart in your model, put your MATLAB function at the chart level and enable exporting of chart-level functions. For more information, see “Export Stateflow Functions for Reuse” on page 8-17.

For example, this MATLAB function has the name `stdevstats`. It takes an argument `vals` and returns an output value `stdevout`.

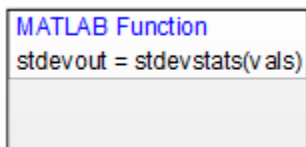

To compute the standard deviation of the values in `vals`, the function uses this code.

```
function stdevout = stdevstats(vals)
%#codegen

% Calculates the standard deviation for vals

len = length(vals);
stdevout = sqrt(sum((vals-avg(vals,len)).^2)/len);

function mean = avg(array,size)
mean = sum(array)/size;
```

Define a MATLAB Function in a Chart

- 1 In the object palette, click the MATLAB function icon . Move your pointer to the location for the new MATLAB function in your chart.
- 2 Enter the signature label for the function, as described in “Declare Function Arguments and Return Values” on page 29-3.

- 3 To program the function, open the MATLAB editor by double-clicking the function box. For more information, see “Program a MATLAB Function in a Chart” on page 29-6.
- 4 In the editor, enter the MATLAB code implementing your function.
- 5 In the Model Explorer, expand the chart object and select the MATLAB function. The arguments and return values of the function signature appear as data items that belong to your function. Arguments have the scope **Input**. Return values have the scope **Output**.
- 6 In the Data properties dialog box for each argument and return value, specify the data properties, as described in “Set Data Properties” on page 9-5.
- 7 Create any additional data items required by your function. For more information, see “Add Data Through the Model Explorer” on page 9-3.

Your function can access its own data or data belonging to parent states or the chart. The data items in the function can have one of these scopes:

- **Local** — Local data persists from one function call to the next function call. Valid for C charts only.
- **Constant** — Constant data retains its initial value through all function calls.
- **Parameter** — Parameter data retains its initial value through all function calls.
- **Temporary** — Temporary data initializes at the start of every function call. Valid for C charts only.

Initialize Function Data

You can initialize your function data (other than arguments and return values) from the MATLAB workspace. For more information, see “Initialize Data from the MATLAB Base Workspace” on page 9-19.

Define Temporary Data

In charts that use C as the action language, define temporary data when you want to use data that is only valid while a function executes. For example, you can designate a loop counter to have **Temporary** scope if the counter value does not need to persist after the function completes.

In charts that use MATLAB as the action language, you do not need to define temporary function data. If you use an undefined variable, Stateflow creates a temporary variable. The variable is available to the rest of the function.

Use Enumerated and Variable-Size Data

In Stateflow charts in Simulink models, you can use enumerated data and variable-size data in MATLAB functions. For more information, see “Code Generation for Enumerations” (Simulink) and “Declare Variable-Size Inputs and Outputs” (Simulink).

Declare Function Arguments and Return Values

The function signature label specifies a name for your function and the formal names for its arguments and return values. A signature label has this syntax:

```
[return_val1,return_val2,...] = function_name(arg1,arg2,...)
```

You can specify multiple return values and multiple input arguments. Each return value and input argument can be a scalar, vector, or matrix of values. For functions with only one return value, omit the brackets in the signature label.

You can use the same variable name for both arguments and return values. For example, a function with this signature label uses the variables `y1` and `y2` as both inputs and outputs:

```
[y1,y2,y3] = f(y1,u,y2)
```

If you export this function to C code, `y1` and `y2` are passed by reference (as pointers), and `u` is passed by value. Passing inputs by reference reduces the number of times that the generated code copies intermediate data, resulting in more optimal code.

Call MATLAB Functions in States and Transitions

You can call MATLAB functions from the actions of any state or transition. You can also call MATLAB functions from other functions. If you export a MATLAB function, you can call it from any chart in the model.

The syntax for a call to a MATLAB function is the same as the function signature, with actual arguments replacing the formal ones specified in a signature. If the data types of an actual and formal argument differ, a function casts the actual argument to the type of the formal argument.

Tip If the formal arguments of a function signature are scalars, verify that inputs and outputs of function calls follow the rules of scalar expansion. For more information, see “Assign Values to All Elements of a Matrix” on page 18-6.

Specify MATLAB Function Properties in a Chart

You can set general properties for your MATLAB function through its properties dialog box. To open the function properties dialog box, right-click the MATLAB function box and select **Properties** from the context menu.

Name

Function name. Click the function name link to open your function in the MATLAB editor.

Function Inline Option

Controls the inlining of your function in generated code:

- **Auto** — Determines whether to inline your function based on an internal calculation.
- **InLine** — Inlines your function if you do not export it to other charts and it is not part of a recursion. (A recursion exists if your function calls itself directly or indirectly through another function call.)
- **Function** — Does not inline your function.

Label

Signature label for your function. For more information, see “Declare Function Arguments and Return Values” on page 29-3.

Saturate on Integer Overflow

Specifies whether integer overflows saturate in the generated code. For more information, see “Handle Integer Overflow for Chart Data” on page 9-36.

MATLAB Function fimath

Defines the `fimath` properties for the MATLAB function. The `fimath` properties specified are associated with all `fi` and `fimath` objects constructed in the MATLAB function. Choose one of these options:

- **Same as MATLAB** — The function uses the same `fimath` properties as the current global `fimath`. The edit box appears dimmed and displays the current global `fimath` in read-only form. For more information on the global `fimath` and `fimath` objects, see the Fixed-Point Designer documentation.
- **Specify Other** — Specify your own `fimath` object by one of these methods:
 - Construct the `fimath` object inside the edit box.
 - Construct the `fimath` object in the MATLAB or model workspace and enter its variable name in the edit box.

Description

Function description. You can enter brief descriptions of functions in the hierarchy.

Document Link

Link to online documentation for the function. You can enter a web URL address or a MATLAB command that displays documentation in a suitable online format, such as an HTML file or text in the MATLAB Command Window. When you click the **Document link** hyperlink, Stateflow displays the documentation.

See Also

More About

- “Program a MATLAB Function in a Chart” on page 29-6
- “Reusable Functions in Charts” on page 2-37
- “Export Stateflow Functions for Reuse” on page 8-17
- “Reuse Functions by Using Atomic Boxes” on page 8-28
- “Enhance Code Readability for MATLAB Function Blocks” (Embedded Coder)

Program a MATLAB Function in a Chart

A MATLAB function in a Stateflow chart is a graphical element that you use to write algorithms that are easier to implement by calling built-in MATLAB functions. This type of function is useful for coding algorithms that are more easily expressed by using MATLAB instead of the graphical Stateflow constructs. For more information, see “Reuse MATLAB Code by Defining MATLAB Functions” on page 29-2.

Inside a MATLAB function, you can call these types of functions:

- Local functions defined in the body of the MATLAB function.
- Graphical, Simulink, truth table, and other MATLAB functions in the chart.
- Built-in MATLAB functions that support code generation. These functions generate C code for building targets that conform to the memory and data type requirements of embedded environments.
- Extrinsic MATLAB functions that do not support code generation. These functions execute only in the MATLAB workspace during simulation of the model. For more information, see “Call Extrinsic MATLAB Functions in Stateflow Charts” on page 31-26.
- Simulink Design Verifier functions for property proving and test generation. These functions include:
 - `sldv.prove`
 - `sldv.assume`
 - `sldv.test`
 - `sldv.condition`

This example shows how to create a model with a Stateflow chart that calls two MATLAB functions, `meanstats` and `stdevstats`:

- `meanstats` calculates the mean of the values in `vals`.
- `stdevstats` calculates a standard deviation for the values in `vals`.

Build Model

Follow these steps:

- 1 Create a new model with the following blocks:

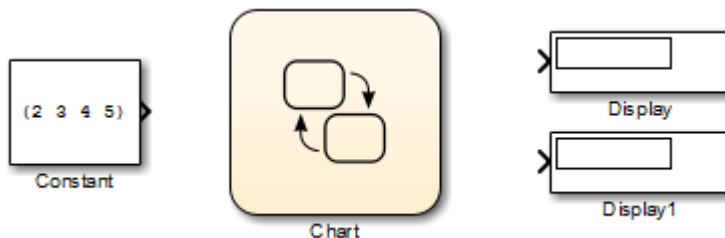

- 2 Save the model as `call_stats_function_stateflow`.
- 3 In the model, double-click the Chart block.

- 4 Drag two MATLAB functions into the empty chart using this icon from the toolbar:



A text field with a flashing cursor appears in the middle of each MATLAB function.

- 5 Label each function as shown:

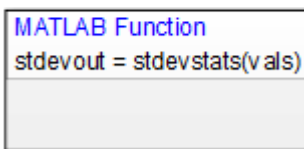
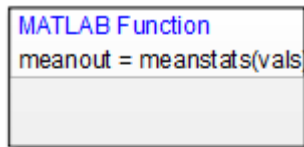

You must label a MATLAB function with its signature. Use the following syntax:

```
[return_val1, return_val2, ...] = function_name(arg1, arg2, ...)
```

You can specify multiple return values and multiple input arguments, as shown in the syntax. Each return value and input argument can be a scalar, vector, or matrix of values.

Note For MATLAB functions with only one return value, you can omit the brackets in the signature label.

- 6 In the chart, draw a default transition into a terminating junction with this condition action:

```
{
mean = meanstats(invals);
stdev = stdevstats(invals);
}
```

The chart should look something like this:

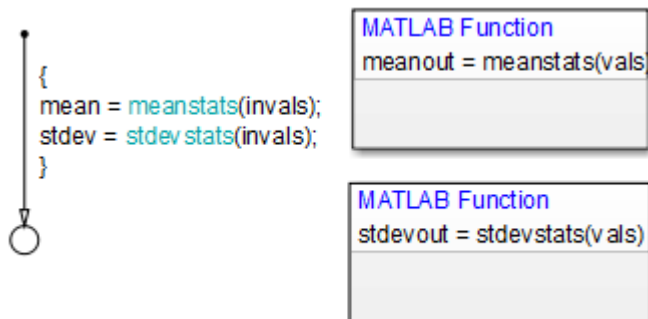

Tip If the formal arguments of a function signature are scalars, verify that inputs and outputs of function calls follow the rules of scalar expansion. For more information, see “Assign Values to All Elements of a Matrix” on page 18-6.

- 7 In the chart, double-click the function `meanstats` to edit its function body in the editor.
- 8 In the function editor, select **Tools > Model Explorer** to open the Model Explorer.

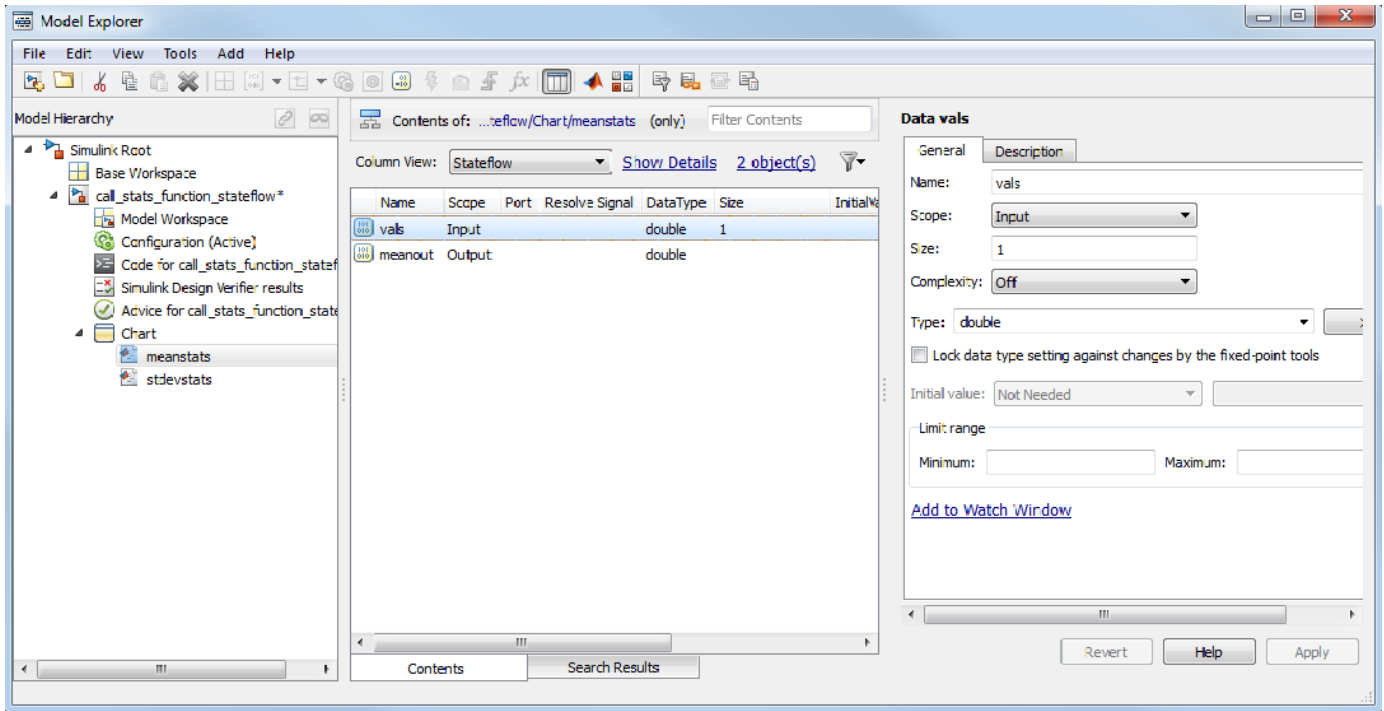

The function `meanstats` is highlighted in the **Model Hierarchy** pane. The **Contents** pane displays the input argument `vals` and output argument `meanout`. Both are scalars of type `double` by default.

- 9 Double-click the `vals` row under the **Size** column to set the size of `vals` to 4.
- 10 Back in the chart, double-click the function `stdevstats` and repeat the previous two steps.
- 11 Back in the **Model Hierarchy** pane of the Model Explorer, select **Chart** and add the following data:

Name	Scope	Size
<code>invals</code>	Input	4
<code>mean</code>	Output	Scalar (no change)
<code>stdev</code>	Output	Scalar (no change)

You should now see the following data in the Model Explorer.

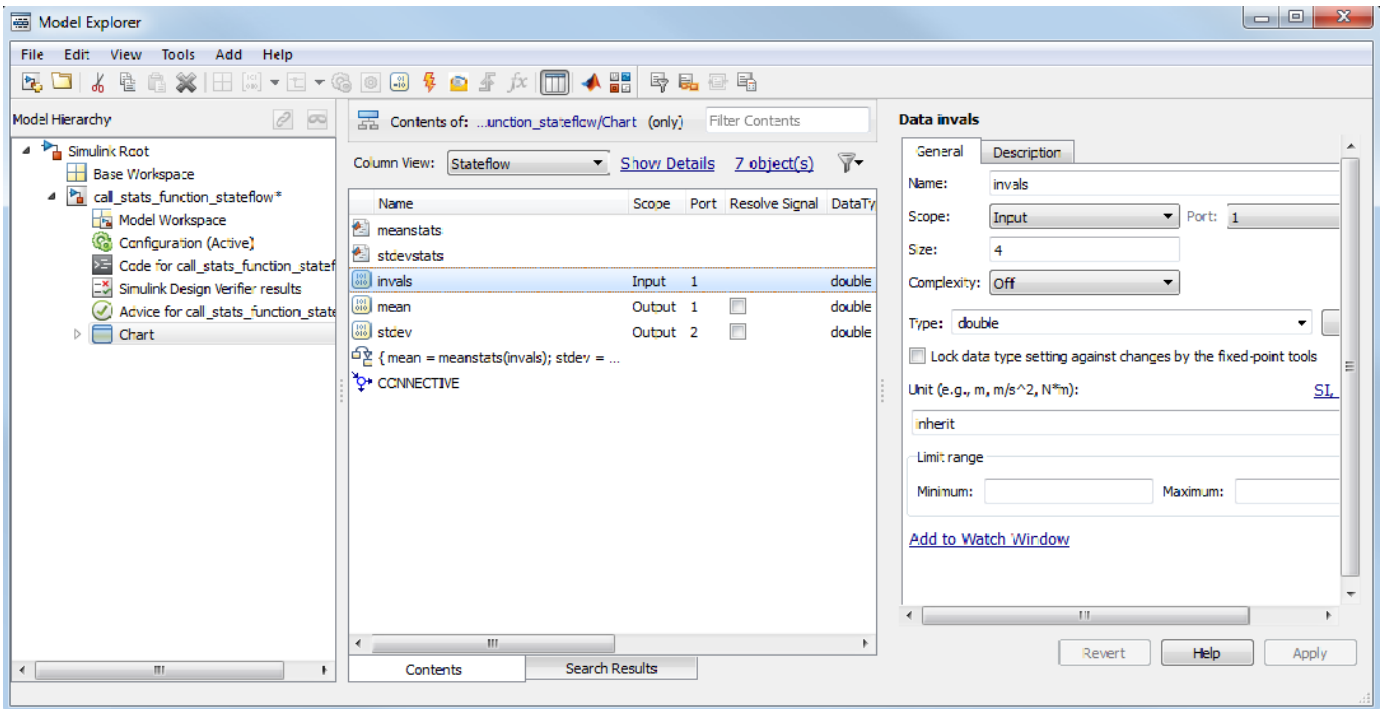

After you add the data `invals`, `mean`, and `stdev` to the chart, the corresponding input and output ports appear on the Stateflow block in the model.

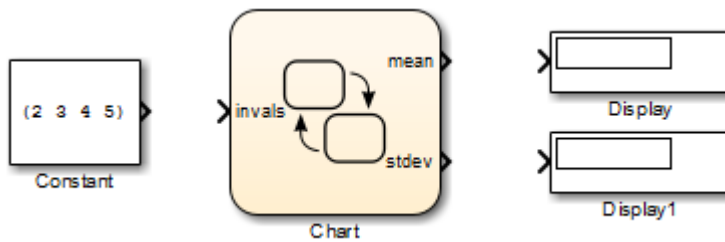

- 12 Connect the Constant and Display blocks to the ports of the Chart block and save the model.

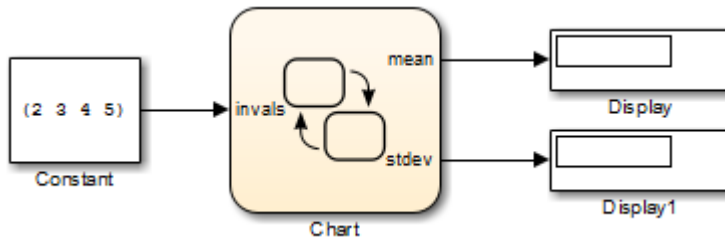

Program MATLAB Functions

To program the functions `meanstats` and `stdevstats`, follow these steps:

- 1 Open the chart in the model `call_stats_function_stateflow`.

- 2 In the chart, open the function `meanstats`.

The function editor appears with the header:

```
function meanout = meanstats(vals)
```

This header is taken from the function label in the chart. You can edit the header directly in the editor, and your changes appear in the chart after you close the editor.

- 3 On the line after the function header, enter:

```
%#codegen
```

The `%#codegen` compilation directive helps detect compile-time violations of syntax and semantics in MATLAB functions supported for code generation.

- 4 Enter a line space and this comment:

```
% Calculates the statistical mean for vals
```

- 5 Add the line:

```
len = length(vals);
```

The function `length` is an example of a built-in MATLAB function that is supported for code generation. You can call this function directly to return the vector length of its argument `vals`. When you build a simulation target, the function `length` is implemented with generated C code. Functions supported for code generation appear in “Functions and Objects Supported for C/C++ Code Generation” (MATLAB Coder).

The variable `len` is an example of implicitly declared local data. It has the same size and type as the value assigned to it — the value returned by the function `length`, a scalar `double`. To learn more about declaring variables, see “Data Definition Basics” (MATLAB Coder).

The MATLAB function treats implicitly declared local data as temporary data, which exists only when the function is called and disappears when the function exits. You can declare local data for a MATLAB function in a chart to be persistent by using the `persistent` construct.

- 6 Enter this line to calculate the value of `meanout`:

```
meanout = avg(vals, len);
```

The function `meanstats` stores the mean of `vals` in the Stateflow data `meanout`. Because these data are defined for the parent Stateflow chart, you can use them directly in the MATLAB function.

Two-dimensional arrays with a single row or column of elements are treated as vectors or matrices in MATLAB functions. For example, in `meanstats`, the argument `vals` is a four-element vector. You can access the fourth element of this vector with the matrix notation `vals(4,1)` or the vector notation `vals(4)`.

The MATLAB function uses the functions `avg` and `sum` to compute the value of `mean`. `sum` is a function supported for code generation. `avg` is a local function that you define later. When resolving function names, MATLAB functions in your chart look for local functions first, followed by functions supported for code generation.

Note If you call a function that the MATLAB function cannot resolve as a local function or a function for code generation, you must declare the function to be extrinsic.

- 7** Now enter this statement:

```
coder.extrinsic('plot');
```

- 8** Enter this line to plot the input values in `vals` against their vector index.

```
plot(vals, '-+');
```

Recall that you declared `plot` to be an extrinsic function because it is not supported for code generation. When the MATLAB function encounters an extrinsic function, it sends the call to the MATLAB workspace for execution during simulation.

- 9** Now, define the local function `avg`, as follows:

```
function mean = avg(array,size)
mean = sum(array)/size;
```

The header for `avg` defines two arguments, `array` and `size`, and a single return value, `mean`. The local function `avg` calculates the average of the elements in `array` by dividing their sum by the value of argument `size`.

The complete code for the function `meanstats` looks like this:

```
function meanout = meanstats(vals)
%#codegen

% Calculates the statistical mean for vals

len = length(vals);
meanout = avg(vals,len);

coder.extrinsic('plot');
plot(vals, '-+');

function mean = avg(array,size)
mean = sum(array)/size;
```

- 10** Save the model.

- 11** Back in the chart, open the function `stdevstats` and add code to compute the standard deviation of the values in `vals`. The complete code should look like this:

```
function stdevout = stdevstats(vals)
%#codegen

% Calculates the standard deviation for vals

len = length(vals);
stdevout = sqrt(sum(((vals-avg(vals,len)).^2))/len);

function mean = avg(array,size)
mean = sum(array)/size;
```

- 12** Save the model again.

Connect Structures in MATLAB Functions to Simulink Bus Signals

About Structures in MATLAB Functions

MATLAB functions support MATLAB structures. You can create structures in top-level MATLAB functions to interface with Simulink bus signals at input and output ports. Simulink buses appear inside the MATLAB function as structures; structure outputs from the MATLAB function appear as buses.

You can also create structures as local and persistent variables in top-level functions and local functions of MATLAB functions.

Define Structures in MATLAB Functions

This section describes how to define structures in MATLAB functions.

- “Rules for Defining Structures in MATLAB Functions” on page 29-12
- “Define Structure Inputs and Outputs to Interface with Bus Signals” on page 29-12
- “Define Local and Persistent Structure Variables” on page 29-13

Rules for Defining Structures in MATLAB Functions

Follow these rules when defining structures for MATLAB functions in Stateflow charts:

- For each structure input or output in a MATLAB function, you must define a `Simulink.Bus` object in the base workspace to specify its type to the Simulink signal.
- MATLAB structures cannot inherit their type from Simulink signals.
- MATLAB functions support nonvirtual buses only (see “Types of Composite Signals” (Simulink)).
- Structures cannot have scopes defined as **Constant**.

Define Structure Inputs and Outputs to Interface with Bus Signals

When you create structure inputs in MATLAB functions, the function determines the type, size, and complexity of the structure from the Simulink input signal. When you create structure outputs, you must define their type, size, and complexity in the MATLAB function.

You can connect MATLAB structure inputs and outputs to any Simulink bus signal, including:

- Simulink blocks that output bus signals — such as Bus Creator blocks
- Simulink blocks that accept bus signals as input — such as Bus Selector and Gain blocks
- S-Function blocks
- Other MATLAB functions

To define structure inputs and outputs for MATLAB functions in Stateflow charts, follow these steps:

- 1 Create a Simulink bus object in the base workspace to specify the properties of the structure you will create in the MATLAB function.

For information about how to create Simulink bus objects, see “Create and Specify Simulink.Bus Objects” (Simulink).

2 Open the Model Explorer and follow these steps:

- a** In the **Model Hierarchy** pane, select the MATLAB function in your chart.
- b** Add a data object, as described in “Add Data Through the Model Explorer” on page 9-3.

The Model Explorer adds a data object and opens a Properties dialog box in its right-hand **Dialog** pane.

- c** In the Properties dialog box, enter the following information in the **General** tab fields:

Field	What to Specify
Name	Enter a name for referencing the structure in the MATLAB function. This name does not have to match the name of the bus object in the base workspace.
Scope	Select Input or Output.
Type	Select Bus: <bus object name> from the drop-down list. Then, replace “<bus object name>” with the name of the Simulink.Bus object in the base workspace that defines the structure. For example: Bus: inbus.

- d** To add or modify Simulink.Bus objects, open the Data Type Assistant. Then, click the **Edit** button to open the Simulink Bus Editor (see “Create and Specify Simulink.Bus Objects” (Simulink)).
 - e** Click **Apply**.
- 3** If your structure is an output (has scope of Output), define the output implicitly in the MATLAB function to have the same type, size, and complexity as its Simulink.Bus object. For details, see “Structures” (MATLAB Coder).

Define Local and Persistent Structure Variables

You can define structures as local or persistent variables inside MATLAB functions. For details, see “Structures” (MATLAB Coder).

Debug a MATLAB Function in a Chart

Check MATLAB Functions for Syntax Errors

Before you can build a simulation application for a model, you must fix syntax errors. Follow these steps to check the MATLAB function `meanstats` for syntax violations:

- 1 Open the function `meanstats` inside the chart in the `call_stats_function_stateflow` model that you constructed in “Program a MATLAB Function in a Chart” on page 29-6.

The editor automatically checks your function code for errors and recommends corrections.

- 2 In the **Apps** tab, click **Simulink Coder**. In the **C Code** tab, click **Build**.

If there are no errors or warnings, the Builder window appears and reports success. Otherwise, it lists errors. For example, if you change the name of local function `avg` to a nonexistent local function `aug` in `meanstats`, errors appear in the Diagnostic Viewer.

- 3 The diagnostic message provides details of the type of error and a link to the code where the error occurred. The diagnostic message also contains a link to a diagnostic report that provides links to your MATLAB functions and compile-time type information for the variables and expressions in these functions. If your model fails to build, this information simplifies finding sources of error messages and aids understanding of type propagation rules. For more information about this report, see “MATLAB Function Reports” (Simulink).
- 4 In the diagnostic message, click the link after the function name `meanstats` to display the offending line of code.

The offending line appears highlighted in the editor.

- 5 Correct the error by changing `aug` back to `avg` and recompile. No errors are found and the compile completes successfully.

Run-Time Debugging for MATLAB Functions in Charts

You use simulation to test your MATLAB functions for run-time errors that are not detectable by Stateflow. When you simulate your model, your MATLAB functions undergo diagnostic tests for missing or undefined information and possible logical conflicts as described in “Check MATLAB Functions for Syntax Errors” on page 29-14. If no errors are found, the simulation of your model begins.

Follow these steps to simulate and debug the `meanstats` function during run-time conditions:

- 1 In the function editor, click the dash (-) character in the left margin of this line:

```
len = length(vals);
```

A small red ball appears in the margin of this line, indicating that you have set a breakpoint.

- 2 Start simulation for the model.

If you get any errors or warnings, make corrections before you try to simulate again. Otherwise, simulation pauses when execution reaches the breakpoint you set. A small green arrow in the left margin indicates this pause.

- 3 To advance execution to the next line, select **Step**.

Notice that this line calls the local function `avg`. If you select **Step** here, execution advances past the execution of the local function `avg`. To track execution of the lines in the local function `avg`, select **Step In** instead.

- 4 To advance execution to the first line of the called local function `avg`, select **Step In**.

Once you are in the local function, you can advance through one line at a time with the **Step** tool. If the local function calls another local function, use the **Step In** tool to step into it. To continue through the remaining lines of the local function and go back to the line after the local function call, select **Step Out**.

- 5 Select **Step** to execute the only line in `avg`.

When `avg` finishes its execution, you see a green arrow pointing down under its last line.

- 6 Select **Step** to return to the function `meanstats`.

Execution advances to the line after the call to `avg`.

- 7 To display the value of the variable `len`, place your pointer over the text `len` in the function editor for at least a second.

The value of `len` appears adjacent to your pointer.

You can display the value for any data in the MATLAB function in this way, no matter where it appears in the function. For example, you can display the values for the vector `vals` by placing your pointer over it as an argument to the function `length`, or as an argument in the function header.

You can also report the values for MATLAB function data in the MATLAB Command Window during simulation. When you reach a breakpoint, the `debug>>` command prompt appears in the MATLAB Command Window (you may have to press **Enter** to see it). At this prompt, you can inspect data defined for the function by entering the name of the data, as shown in this example:

```
debug>> len
len =
     4
debug>>
```

As another debugging alternative, you can display the execution result of a function line by omitting the terminating semicolon. If you do, execution results appear in the MATLAB Command Window during simulation.

- 8 To leave the function until it is called again and the breakpoint is reached, select **Continue**.

At any point in a function, you can advance through the execution of the remaining lines of the function with the **Continue** tool. If you are at the end of the function, selecting **Step** does the same thing.

- 9 Click the breakpoint to remove it and select **Quit Debugging** to complete the simulation.

In the model, the computed values of `mean` and `stdev` now appear in the Display blocks.

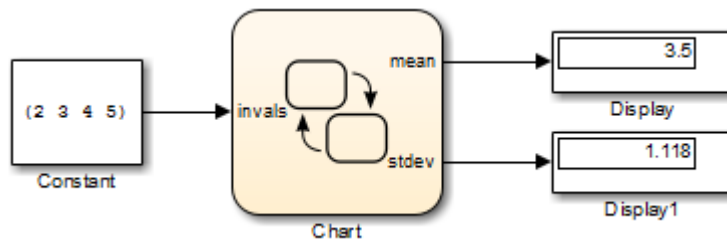

Check for Data Range Violations

To control data range checking, set **Simulation range checking** in the **Diagnostics: Data Validity** pane of the Model Configuration Parameters dialog box.

Specify a Range

To specify a range for input and output data, follow these steps:

- 1 In the Model Explorer, select the MATLAB function input or output of interest.

The Data properties dialog box opens in the **Dialog** pane of the Model Explorer.

- 2 In the Data properties dialog box, click the **General** tab and enter a limit range, as described in “Limit Range” on page 9-9.

Simulink Functions in Stateflow Charts

- “Reuse Simulink Components in Stateflow Charts” on page 30-2
- “Share Functions Across Simulink and Stateflow” on page 30-6
- “Why Use a Simulink Function in a Stateflow Chart?” on page 30-8
- “Define a Simulink Function in a Stateflow Chart” on page 30-13
- “Bind a Simulink Function to a State” on page 30-15
- “Improve Chart Design by Using Simulink Functions” on page 30-20
- “Schedule Execution of Multiple Controllers” on page 30-28

Reuse Simulink Components in Stateflow Charts

A Simulink function is a graphical object that you fill with Simulink blocks and call in the actions of states and transitions. Simulink functions are supported only in Stateflow charts in Simulink models.

Simulink functions provide an efficient model design and improve readability by minimizing graphical and nongraphical objects. Typical applications include:

- Defining a function that requires Simulink blocks, such as lookup tables (see “About Lookup Table Blocks” (Simulink))
- Scheduling execution of multiple controllers

You can call Simulink functions defined inside of a Stateflow chart from the same chart. You can also call functions defined by a Simulink Function block in the model.

Where to Define a Simulink Function in a Chart

A Simulink function can reside anywhere in a chart, state, or subchart. The location of a function determines its scope, that is, the set of states and transitions that can call the function. Follow these guidelines:

- If you want to call the function within only one state or subchart and its substates, put your Simulink function in that state or subchart. That function overrides any other functions of the same name in the parents and ancestors of that state or subchart.
- If you want to call the function anywhere in that chart, put your Simulink function at the chart level.

Call a Simulink Function from Multiple Sites in a Chart

If you call a Simulink function from multiple sites in a chart, all call sites share the state of the function variables. For example, suppose you have a chart with two calls to the same Simulink function at each time step.

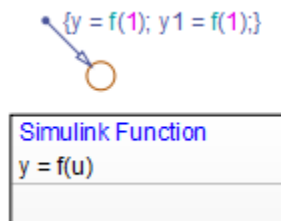

The function `f` contains a block diagram that increments a counter by 1 each time the function executes.

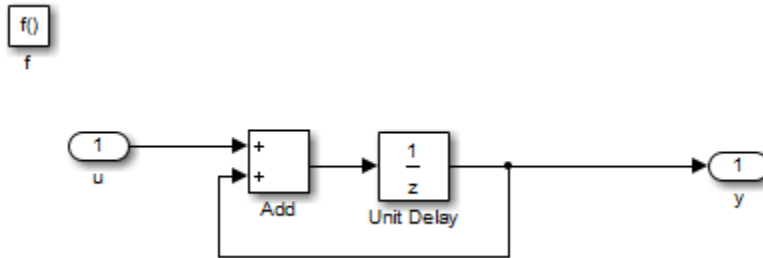

At each time step, the function `f` is called twice, which causes the counter to increment by 2. Because all call sites share the value of this counter, the data `y` and `y1` increment by 2 at each time step.

Note This behavior also applies to external function-call subsystems in a Simulink model. For more information, see “Using Function-Call Subsystems” (Simulink).

Rules for Using Simulink Functions in Stateflow Charts

Do not call Simulink functions in state during actions or transition conditions of continuous-time charts

This rule applies to continuous-time charts because you cannot call functions during minor time steps. You can call Simulink functions in state entry or exit actions and transition actions. However, if you try to call Simulink functions in state during actions or transition conditions, an error message appears when you simulate your model.

For more information, see “Continuous-Time Modeling in Stateflow” on page 22-2.

Do not call Simulink functions in default transitions if you enable execute-at-initialization mode

If you select **Execute (enter) Chart At Initialization** in the Chart properties dialog box, you cannot call Simulink functions in default transitions that execute the first time that the chart awakens. Otherwise, an error message appears when you simulate your model.

Use only alphanumeric characters or underscores when naming input and output ports for a Simulink function

This rule ensures that the names of input and output ports are compatible with identifier naming rules of Stateflow charts.

Note Any space in a name automatically changes to an underscore.

Convert discontinuous signals to contiguous signals for Simulink functions

For Simulink functions inside a Stateflow chart, the output ports do not support discontinuous signals. If your function contains a block that outputs a discontinuous signal, insert a Signal Conversion block between the discontinuous output and the output port. This action ensures that the output signal is contiguous.

Blocks that can output a discontinuous signal include the Bus Creator block and the Mux block. For the Bus Creator block, the output is discontinuous only if you clear the **Output as nonvirtual bus**

check box — that is, if the Bus Creator block outputs a virtual bus. If you select **Output as nonvirtual bus**, the output signal is contiguous and no conversion is necessary.

For more information, see Bus Creator, Mux, and Signal Conversion.

Do not export Simulink functions

If you try to export Simulink functions, an error appears when you simulate your model. To avoid this behavior, clear the **Export Chart Level Functions** check box in the Chart properties dialog box.

Use the Stateflow Editor to rename a Simulink function

If you try to use the Model Explorer to rename a Simulink function, the change does not appear in the chart. Edit the name in the Symbols pane or click the function box in the Stateflow Editor to rename the function.

Do not use Simulink functions in Moore charts

This restriction prevents violations of Moore semantics during chart execution. For more information, see “Design Considerations for Moore Charts” on page 7-9.

Do not generate HDL code for Simulink functions

If you try to generate HDL code for charts that contain Simulink functions, an error message appears when you simulate your model. HDL code generation does not support Simulink functions.

Set properties of input ports explicitly for a Simulink function

The input ports of Simulink functions cannot inherit their sizes and data types. The output ports of a Simulink Function block in Simulink cannot inherit their sizes and data types. Therefore, you must set sizes and types explicitly when the inputs and outputs are not scalar data of type `double`.

The output ports of a Simulink function defined inside a chart can inherit sizes and data types based on connections inside the subsystem. Therefore, you can specify sizes and types of these outputs as inherited.

Tip To minimize updates required for changes in input port properties, you can specify sizes and data types as parameters.

Verify that function-call expressions have inputs and outputs of correct size

If the formal arguments of a function signature are scalars, verify that inputs and outputs of function calls follow the rules of scalar expansion. For more information, see “Assign Values to All Elements of a Matrix” on page 18-6.

Pass arguments by value

Passing an argument to a Simulink function by reference generates a run-time error during simulation.

See Also

Simulink Function

More About

- “Export Stateflow Functions for Reuse” on page 8-17
- “Simulink Functions Overview” (Simulink)
- “Simulink functions: Simulink Function block, exported Stateflow graphical and MATLAB functions” (Simulink)
- “Share Functions Across Simulink and Stateflow” on page 30-6

Share Functions Across Simulink and Stateflow

Communicate and Share Resources with Functions

This example shows a model calling functions across Simulink® and Stateflow®. The `slexPrinterExample` model has three computer clients sharing a printer. Each computer creates print jobs by calling the Simulink function `addPrintJob`.

In this example, the Stateflow chart communicates with the model by:

- Defining and exporting a graphical function that is called by Simulink.
- Calling a Simulink function that is defined in Simulink.

```
open_system('slexPrinterExample');
```

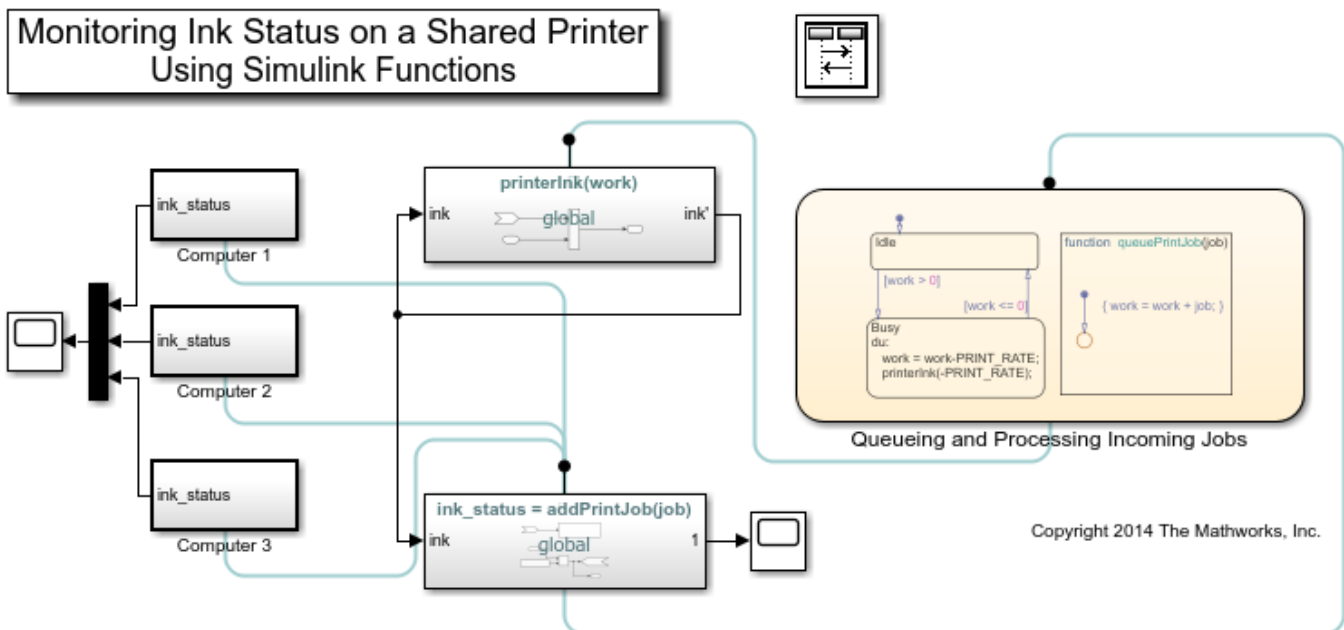

Each computer client invokes the printer server with a call to the Simulink function, `addPrintJob`. The `addPrintJob` function calls the Stateflow graphical function `queuePrintJob` to add the print job to the work load. The chart processes the work and calls the Simulink function `printerInk` to model usage of printer ink.

Call a Simulink Function from Stateflow

The function `printerInk` is defined in a Simulink Function block at the top level of the model. The function interface `printerInk(work)` defines one input argument. The Simulink Function, `printerInk`, also interacts with the model with signal lines through the inport `ink` and outport `ink'`. The state `Busy` matches the function signature for `printerInk(work)` by passing one input argument.

```
open_system('slexPrinterExample/Queueing and Processing Incoming Jobs')
```

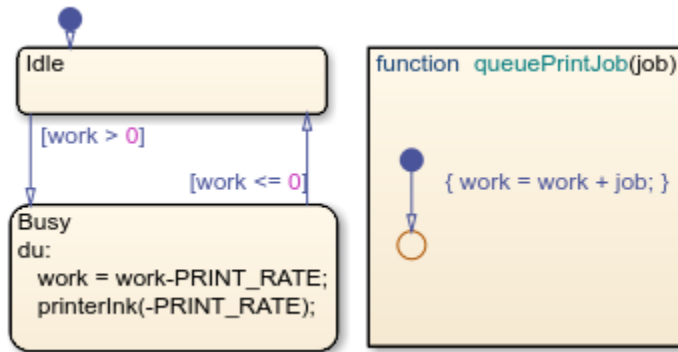

Export Stateflow Functions to Simulink

In the chart *Queuing and Processing Incoming Jobs*, the properties **Export Chart Level Functions** and **Treat Exported Functions as Globally Visible** are selected. These properties allow the Simulink function `addPrintJob` to call the chart graphical function, `queuePrintJob`.

See Also

Simulink Function

More About

- “Export Stateflow Functions for Reuse” on page 8-17
- “Simulink Functions Overview” (Simulink)
- “Model Reference Basics” (Simulink)

Why Use a Simulink Function in a Stateflow Chart?

In this section...

“Advantages of Using Simulink Functions in a Stateflow Chart” on page 30-8

“Benefits of Using a Simulink Function to Access Simulink Blocks” on page 30-8

“Benefits of Using a Simulink Function to Schedule Execution of Multiple Controllers” on page 30-10

Advantages of Using Simulink Functions in a Stateflow Chart

When you define a function that uses Simulink function-call subsystem blocks or schedule execution of multiple controllers without Simulink functions, the model requires these elements:

- Simulink function-call subsystem blocks
- Stateflow chart with function-call output events
- Signal lines between the chart and each function-call subsystem port

Simulink functions in a Stateflow chart provide these advantages:

- No function-call subsystem blocks
- No output events
- No signal lines

Benefits of Using a Simulink Function to Access Simulink Blocks

The sections that follow compare two ways of defining a function that uses Simulink blocks.

Model Method Without a Simulink Function

You define a function-call subsystem in the Simulink model (see “Using Function-Call Subsystems” (Simulink)). Use an output event in a Stateflow chart to call the subsystem, as shown.

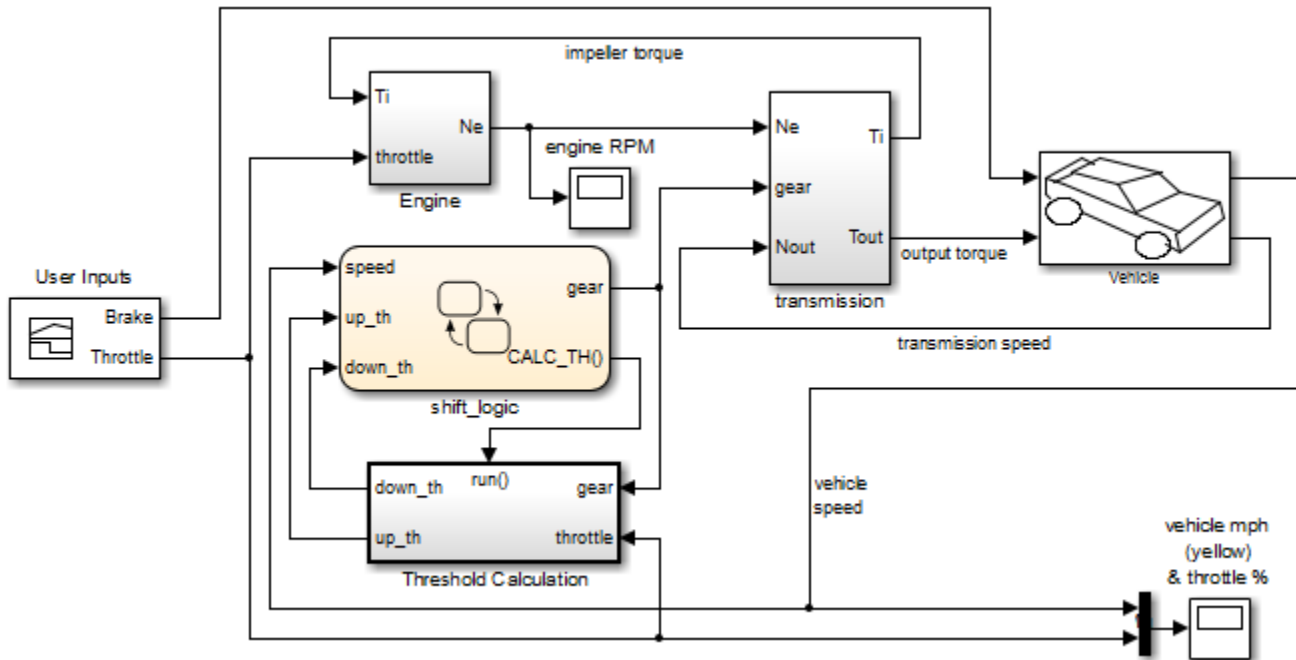

Model Method With a Simulink Function

You place one or more Simulink blocks in a Simulink function of a Stateflow chart. Use a function call to execute the blocks in that function, as shown.

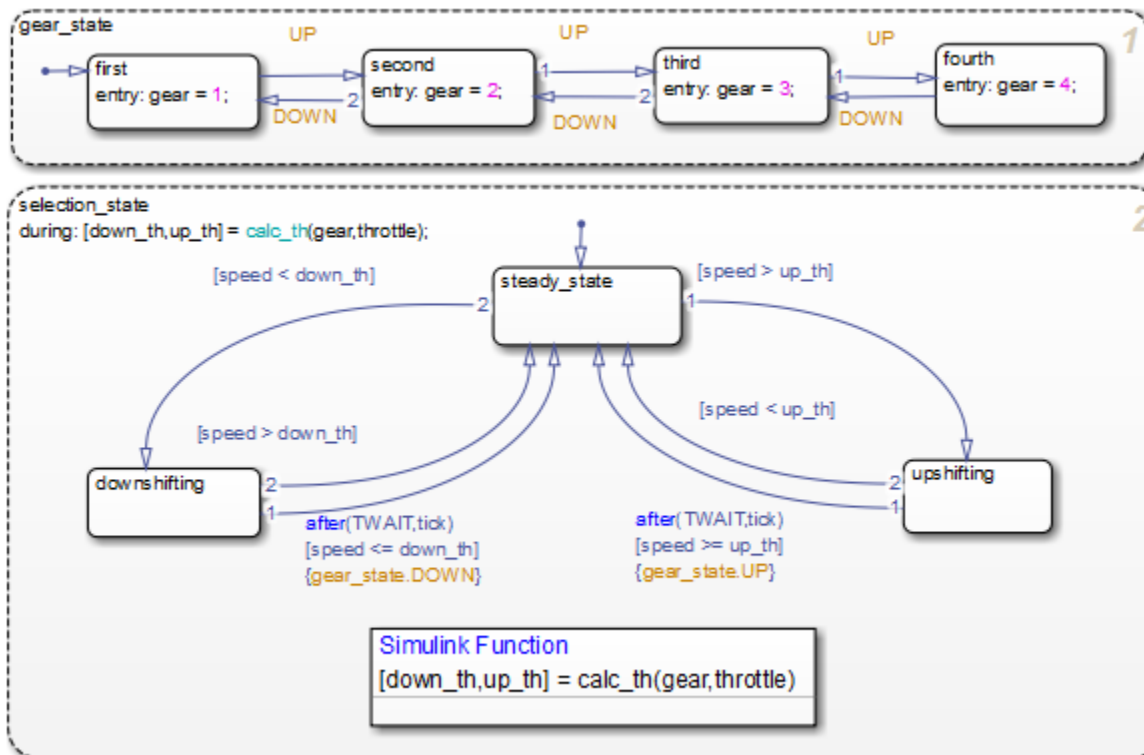

In the chart, the during action in `selection_state` contains a function call to `calc_th`, which is a function that contains Simulink blocks.

This modeling method minimizes the objects in your model.

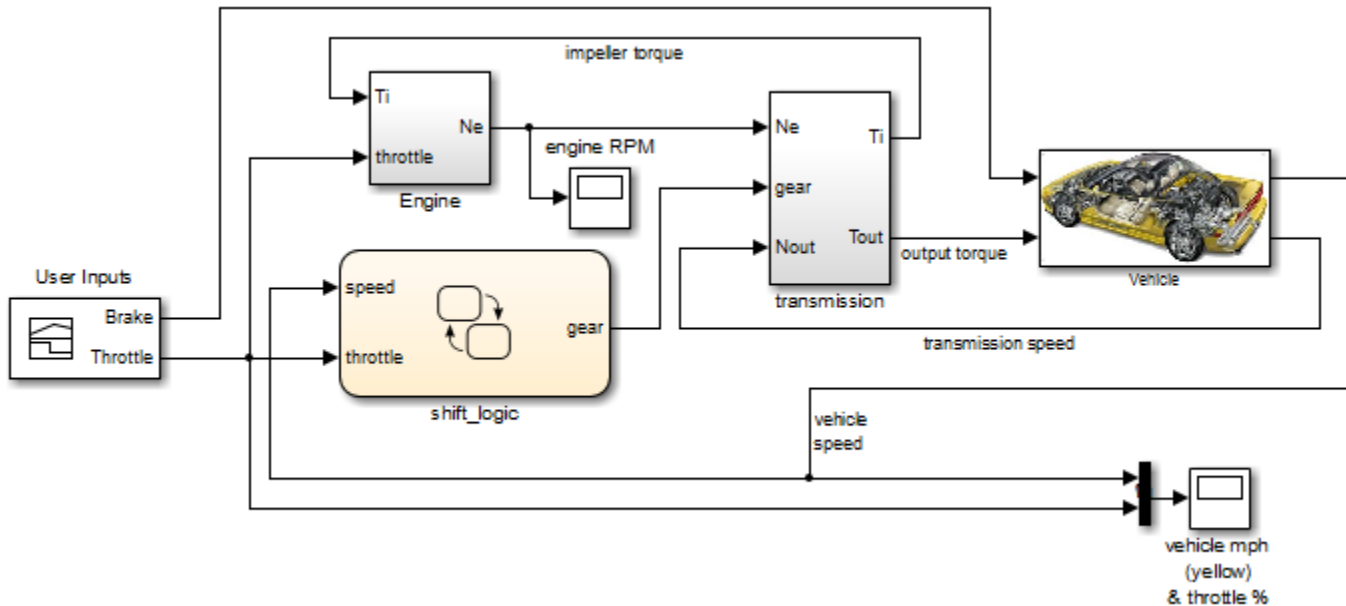

For more information, see “Improve Chart Design by Using Simulink Functions” on page 30-20.

Benefits of Using a Simulink Function to Schedule Execution of Multiple Controllers

The sections that follow compare two ways of scheduling execution of multiple controllers.

Model Method Without Simulink Functions

You define each controller as a function-call subsystem block and use output events in a Stateflow chart to schedule execution of the subsystems, as shown in the `sf_temporal_logic_scheduler` model.

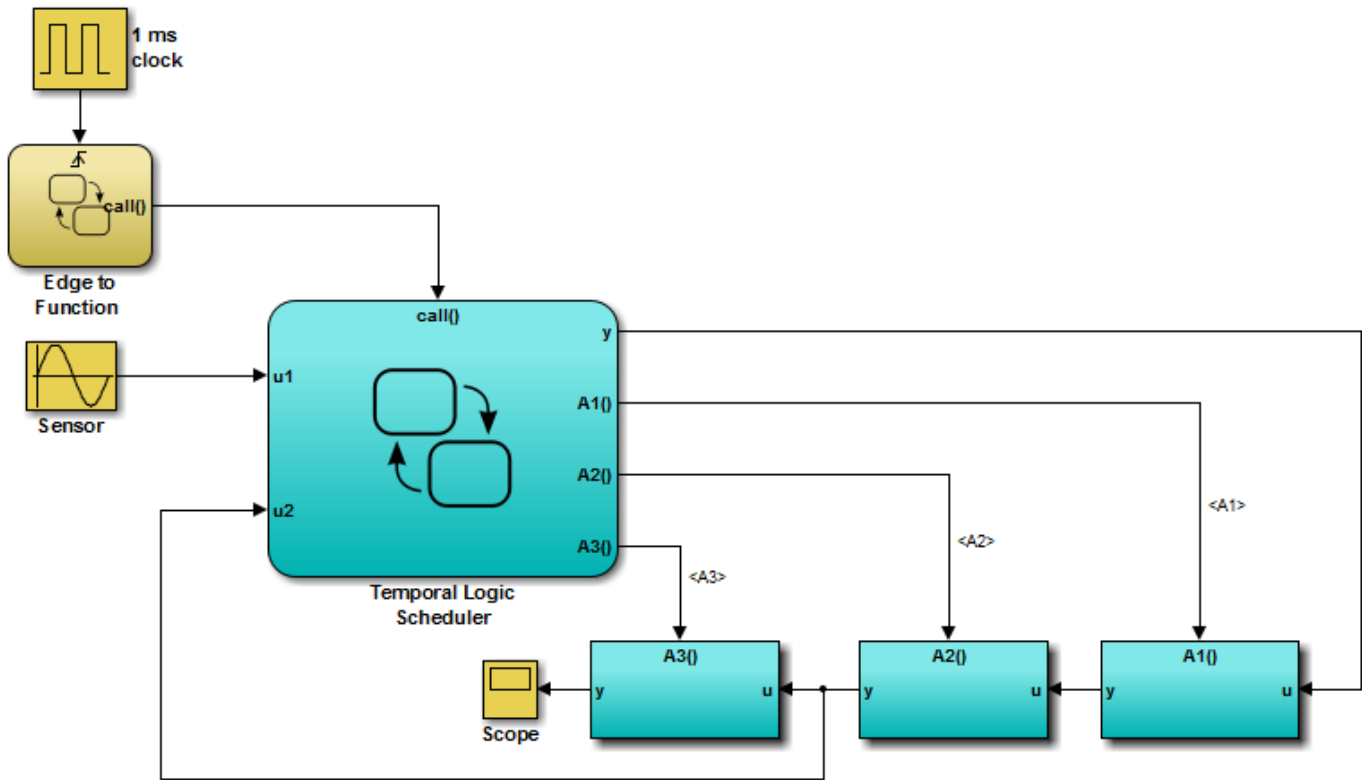

Model Method With Simulink Functions

You define each controller as a Simulink function in a Stateflow chart and use function calls to schedule execution of the subsystems, as shown in the sf_temporal_logic_scheduler_with_sl_fcns model.

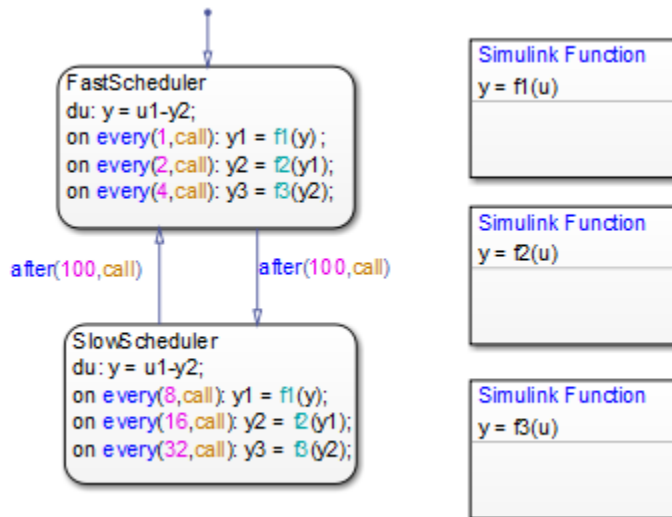

This modeling method minimizes the objects in your model.

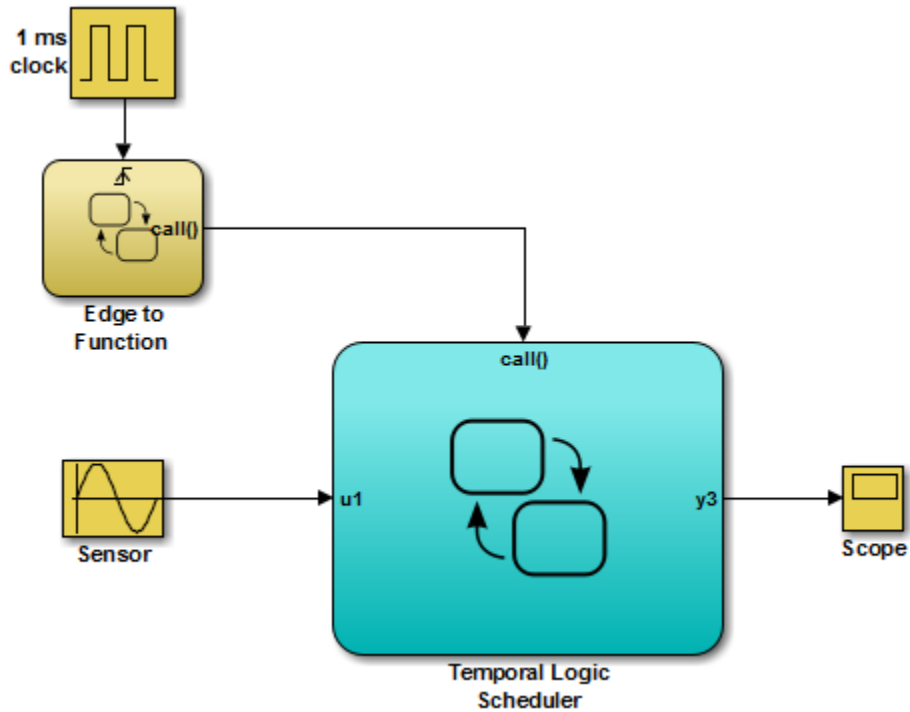

See Also

More About

- “Benefits of Using a Simulink Function to Access Simulink Blocks” on page 30-8
- “Benefits of Using a Simulink Function to Schedule Execution of Multiple Controllers” on page 30-10
- “Schedule Execution of Multiple Controllers” on page 30-28

Define a Simulink Function in a Stateflow Chart

A Simulink function is a graphical object that you fill with Simulink blocks and call in the actions of states and transitions. Simulink functions are supported only in Stateflow charts in Simulink models. For more information, see “Reuse Simulink Components in Stateflow Charts” on page 30-2.

Task 1: Add a Function to the Chart

Follow these steps to add a Simulink function to the chart:

- 1 Click the Simulink function icon in the Stateflow Editor toolbar:



- 2 Move your pointer to the location for the new Simulink function in your chart and click to insert the function box.

Tip You can also drag the function from the toolbar.

- 3 Enter the function signature.

The function signature specifies a name for your function and the formal names for the arguments and return values. A signature has this syntax:

$$[r_1, r_2, \dots, r_n] = \text{simfcn}(a_1, a_2, \dots, a_n)$$

where `simfcn` is the name of your function, `a_1`, `a_2`, ..., `a_n` are formal names for the arguments, and `r_1`, `r_2`, ..., `r_n` are formal names for the return values.

Note This syntax is the same as what you use for graphical functions, truth tables, and MATLAB functions. You can define arguments and return values as scalars, vectors, or matrices of any data type.

- 4 Click outside the function box.

The following example shows a Simulink function that has the name `sim_fcn`, which takes three arguments (`a`, `b`, and `c`) and returns two values (`x` and `y`).

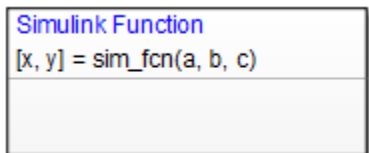

Note You can also create and edit a Simulink function by using API methods.

Task 2: Define the Subsystem Elements of the Simulink Function

Follow these steps to define the subsystem elements of the Simulink function:

- 1 Double-click the Simulink function box.

The contents of the subsystem appear: input and output ports that match the function signature and a single function-call trigger port.

- 2 Add Simulink blocks to the subsystem.
- 3 Connect the input and output ports to each block.

Note You cannot delete the trigger port in the function.

The following example shows the subsystem elements for a Simulink function.

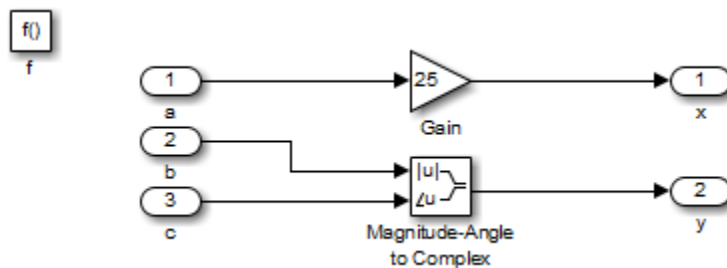

Task 3: Configure the Function Inputs

Follow these steps to configure inputs for the Simulink function:

- 1 Configure the input ports.
 - a Double-click an input port to open the Block Parameters dialog box.
 - b In the **Signal Attributes** pane, enter the size and data type.

For example, you can specify a size of [2 3] for a 2-by-3 matrix and a data type of `uint8`.

- 2 Click **OK**.

Note An input port of a Simulink function cannot inherit size or data type. Therefore, you define the size and data type of an input that is not scalar data of type `double`. However, an output port can inherit size and data type.

See Also

More About

- “Reuse Simulink Components in Stateflow Charts” on page 30-2
- “Why Use a Simulink Function in a Stateflow Chart?” on page 30-8
- “Share Functions Across Simulink and Stateflow” on page 30-6

Bind a Simulink Function to a State

A Simulink function is a graphical object that you fill with Simulink blocks and call in the actions of states and transitions. Simulink functions are supported only in Stateflow charts in Simulink models. For more information, see “Reuse Simulink Components in Stateflow Charts” on page 30-2.

Bind Behavior of a Simulink Function

When a Simulink function resides inside a state, the function binds to that state. Binding results in the following behavior:

- Function calls can occur only in state actions and on transitions within the state and its substates.
- When the state is entered, the function is enabled.
- When the state is exited, the function is disabled.

For example, the following Stateflow chart shows a Simulink function that binds to a state.

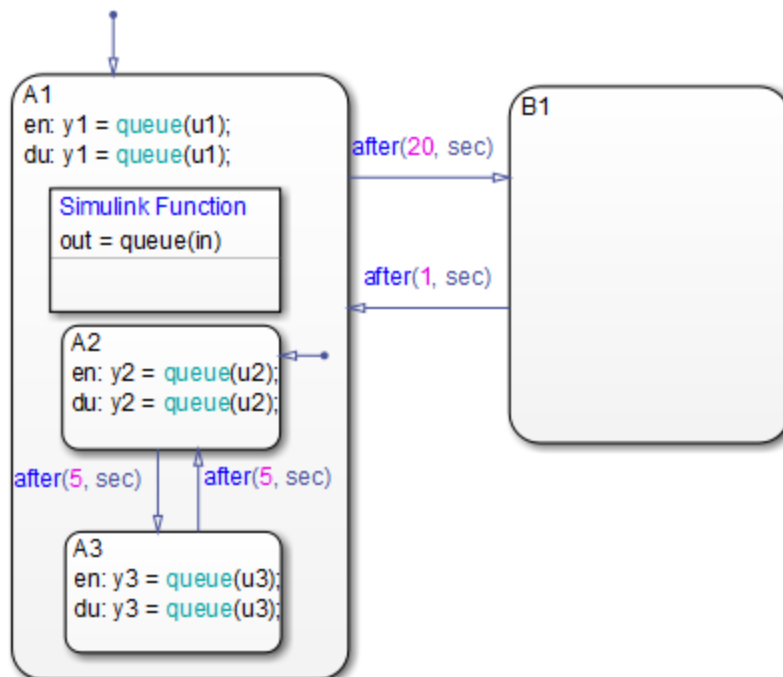

Because the function `queue` resides in state A1, the function binds to that state.

- State A1 and its substates A2 and A3 can call `queue`, but state B1 cannot.
- When state A1 is entered, `queue` is enabled.
- When state A1 is exited, `queue` is disabled.

Control Subsystem Variables When the Simulink Function Is Disabled

If a Simulink function binds to a state, you can hold the subsystem variables at their values from the previous execution or reset the variables to their initial values. Follow these steps:

- 1 In the Simulink function, double-click the trigger port to open the Block Parameters dialog box.
- 2 Select an option for **States when enabling**.

Option	Description	Reference Section
held	Holds the values of the subsystem variables from the previous execution	“How the Function Behaves When Variables Are Held” on page 30-18
reset	Resets the subsystem variables to their initial values	“How the Function Behaves When Variables Are Reset” on page 30-19

Example of Binding a Simulink Function to a State

This example shows how a Simulink function behaves when bound to a state.

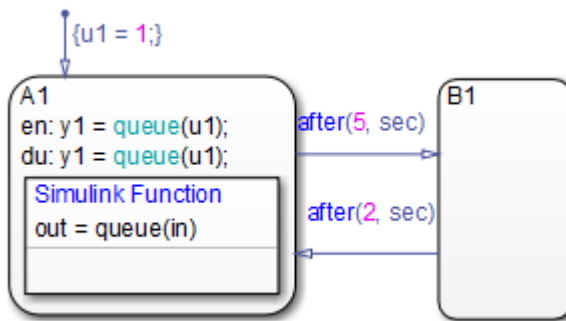

The function `queue` contains a block diagram that increments a counter by 1 each time the function executes.

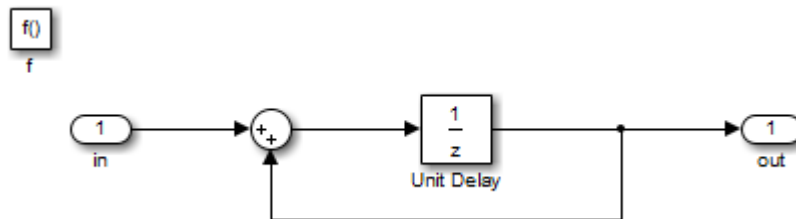

The Block Parameters dialog box for the trigger port appears as follows.

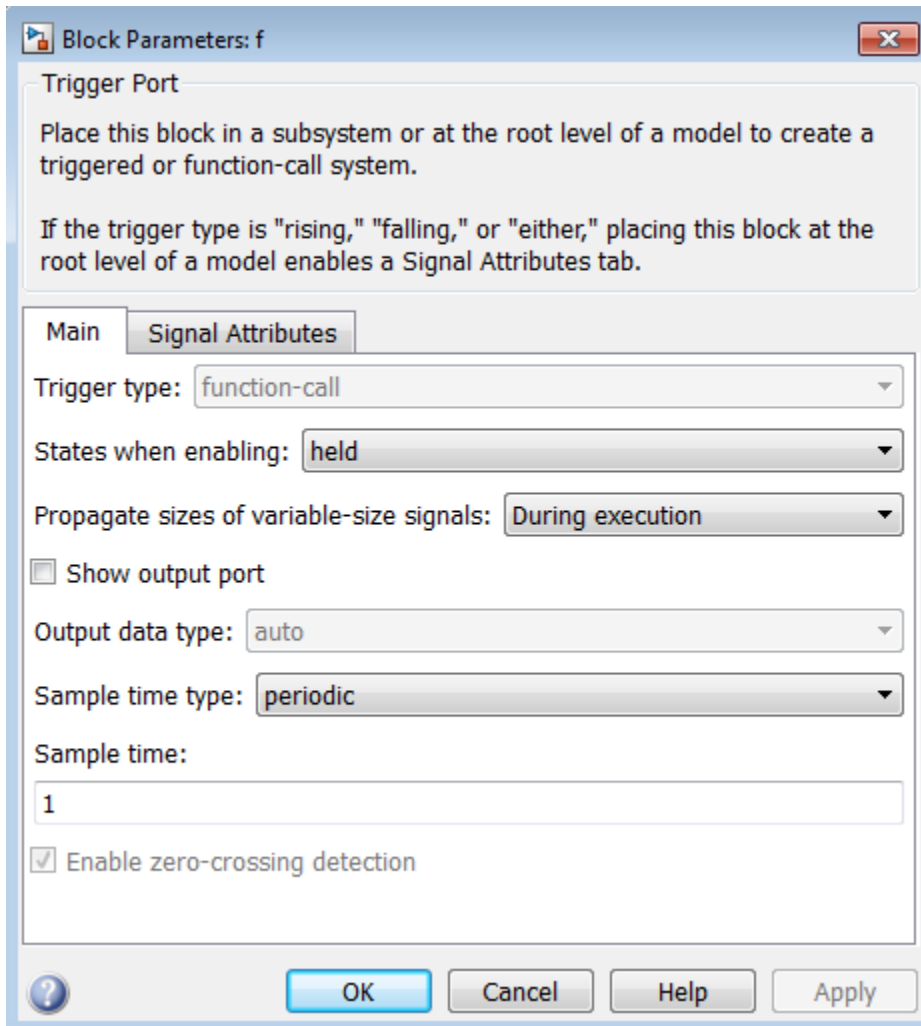

In the dialog box, setting **Sample time type** to periodic enables the **Sample time** field, which defaults to 1. These settings tell the function to execute for each time step specified in the **Sample time** field while the function is enabled.

Note If you use a fixed-step solver, the value in the **Sample time** field must be an integer multiple of the fixed-step size. This restriction does not apply to variable-step solvers. (For more information, see "Compare Solvers" (Simulink).)

Simulation Behavior of the Chart

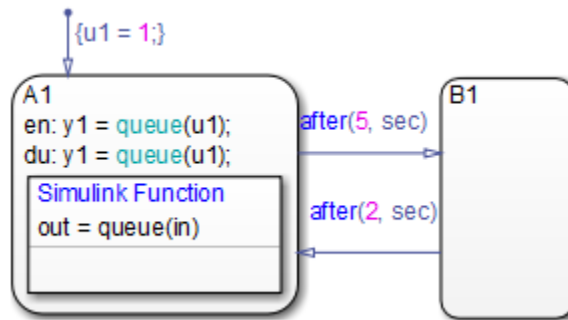

When you simulate the chart, the following actions occur:

- 1 The default transition to state A1 occurs, which includes setting local data `u1` to 1.
- 2 When A1 is entered, the function `queue` is enabled.
- 3 Function calls to `queue` occur until the condition `after(5, sec)` is true.
- 4 The transition from state A1 to B1 occurs.
- 5 When A1 is exited, the function `queue` is disabled.
- 6 After two more seconds pass, the transition from B1 to A1 occurs.
- 7 Steps 2 through 6 repeat until the simulation ends.

How the Function Behaves When Variables Are Held

If you set **States when enabling** to held, the output `y1` is as follows.

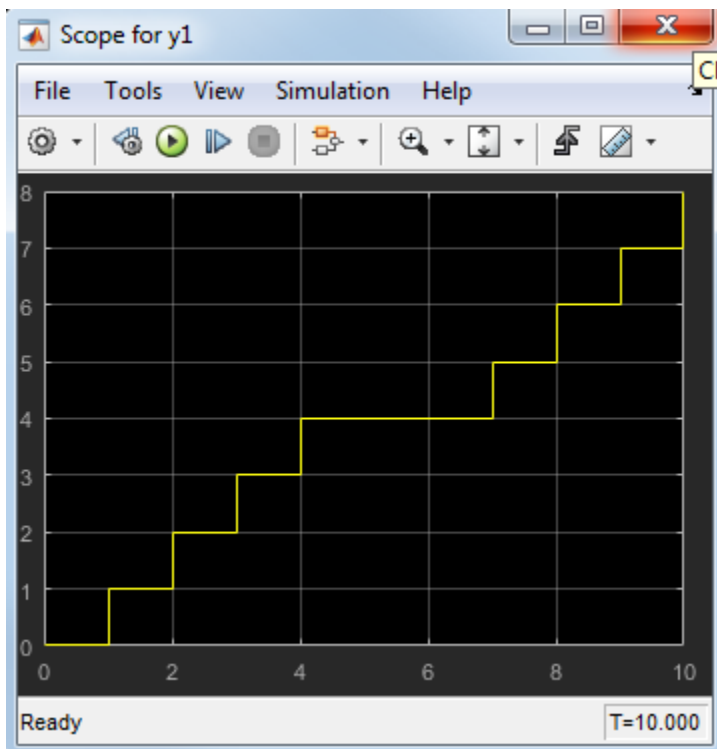

When state A1 becomes inactive at $t = 5$, the Simulink function holds the counter value. When A1 is active again at $t = 7$, the counter has the same value as it did at $t = 5$. Therefore, the output $y1$ continues to increment over time.

How the Function Behaves When Variables Are Reset

If you set **States when enabling** to reset, the output $y1$ is as follows.

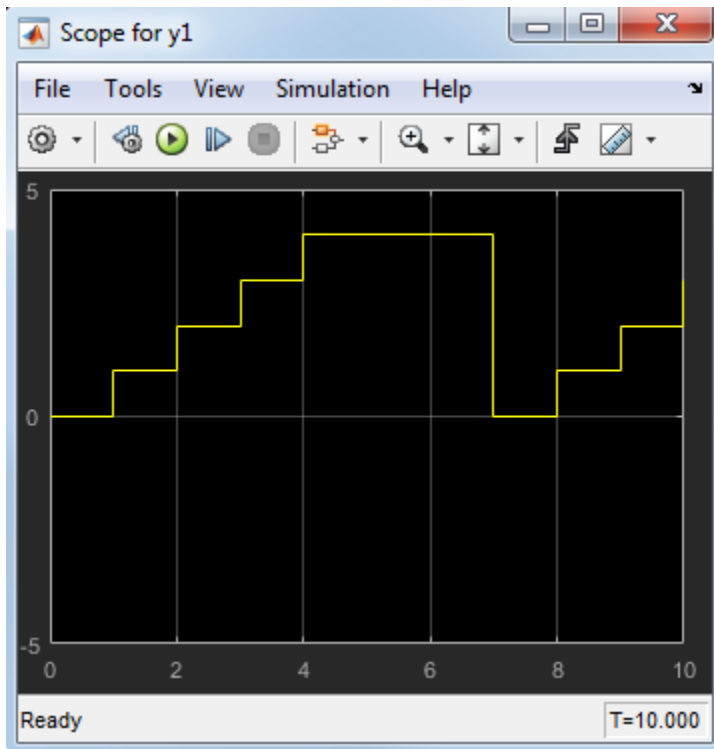

When state A1 becomes inactive at $t = 5$, the Simulink function does *not* hold the counter value. When A1 is active again at $t = 7$, the counter resets to zero. Therefore, the output $y1$ resets too.

See Also

More About

- "Reuse Simulink Components in Stateflow Charts" on page 30-2
- "Why Use a Simulink Function in a Stateflow Chart?" on page 30-8

Improve Chart Design by Using Simulink Functions

A Simulink function is a graphical object that you fill with Simulink blocks and call in the actions of states and transitions. Simulink functions are supported only in Stateflow charts in Simulink models. For more information, see “Reuse Simulink Components in Stateflow Charts” on page 30-2.

Goal of the Tutorial

The goal of this tutorial is to use a Simulink function in a Stateflow chart to improve the design of a model named `old_sf_car`.

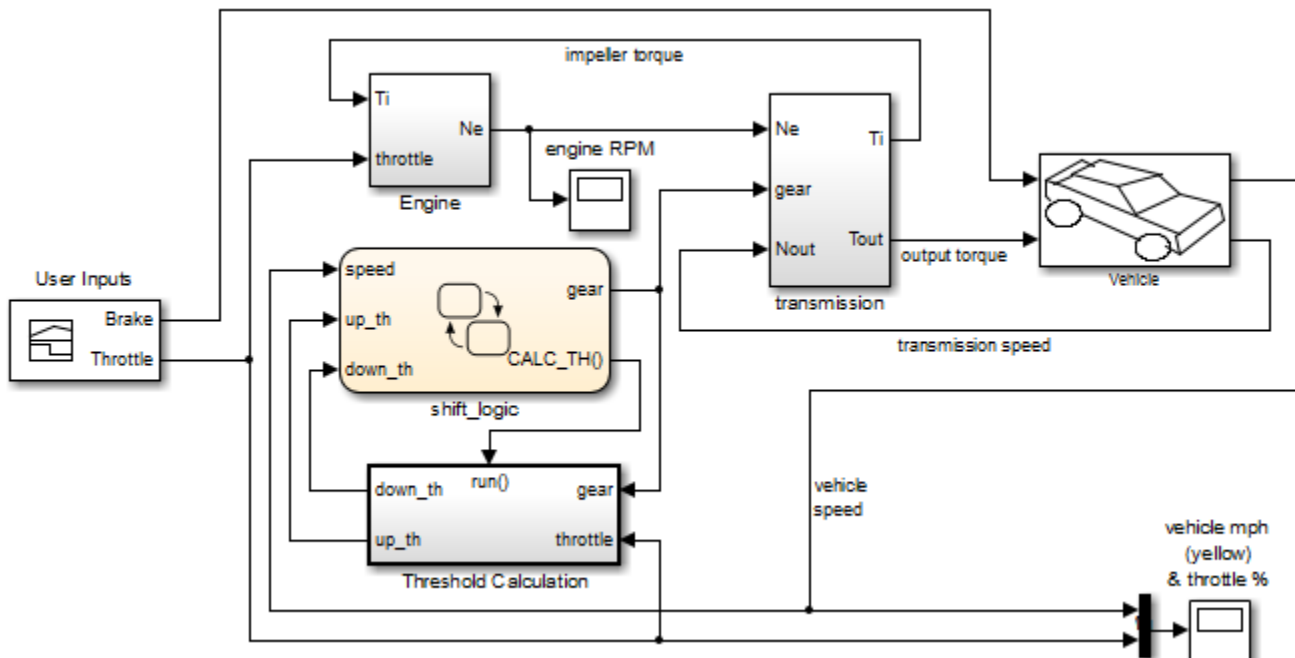

Rationale for Improving the Model Design

The `old_sf_car` model contains a function-call subsystem named `Threshold Calculation` and a Stateflow chart named `shift_logic`. The two blocks interact as follows:

- The chart broadcasts the output event `CALC_TH` to trigger the function-call subsystem.
- The subsystem uses lookup tables to interpolate two values for the `shift_logic` chart.
- The subsystem outputs (`up_th` and `down_th`) feed directly into the chart as inputs.

No other blocks in the model access the subsystem outputs.

You can replace a function-call subsystem with a Simulink function in a chart when:

- The subsystem performs calculations required by the chart.
- Other blocks in the model do not need access to the subsystem outputs.

Edit a Model to Use a Simulink Function

The sections that follow describe how to replace a function-call subsystem in a Simulink model with a Simulink function in a Stateflow chart. This procedure reduces the number of objects in the model while retaining the same simulation results.

Step	Task	Reference
1	Open the model.	"Open the Model" on page 30-21
2	Move the contents of the function-call subsystem into a Simulink function in the chart.	"Add a Simulink Function to the Chart" on page 30-23
3	Change the scope of specific chart-level data to <code>Local</code> .	"Change the Scope of Chart Data" on page 30-25
4	Replace the event broadcast with a function call.	"Update State Action in the Chart" on page 30-25
5	Verify that function inputs and outputs are defined.	"Add Data to the Chart" on page 30-26
6	Remove unused items in the model.	"Remove Unused Items in the Model" on page 30-26

Note To skip the conversion steps, open the model `sf_car`.

Open the Model

Open the model `old_sf_car`. If you simulate the model, you see these results in the two scopes.

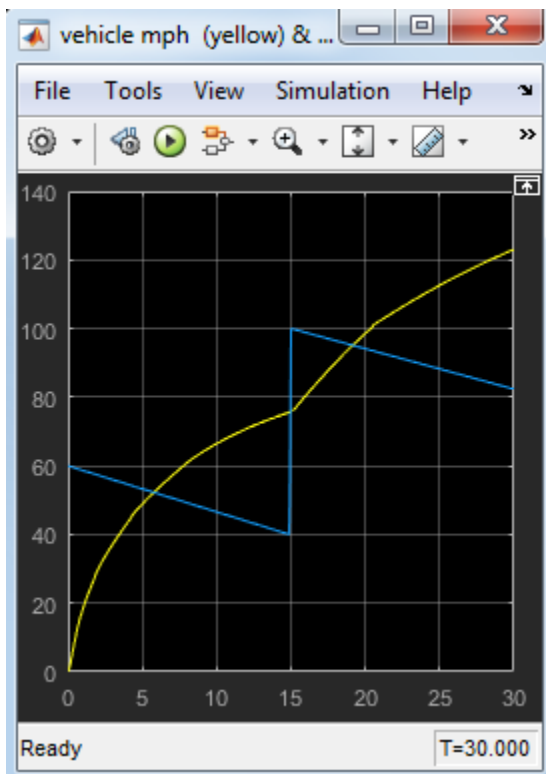
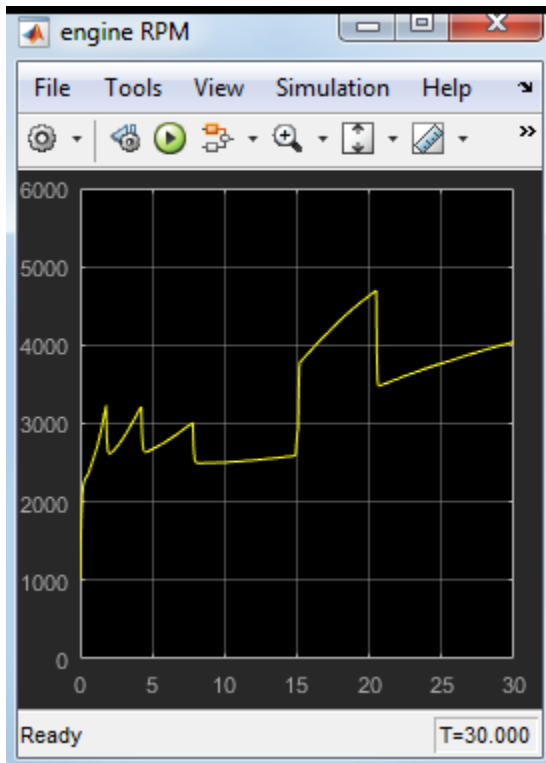

Add a Simulink Function to the Chart

Follow these steps to add a Simulink function to the shift_logic chart.

- 1 In the Simulink model, right-click the Threshold Calculation block in the lower left corner and select **Cut** from the context menu.

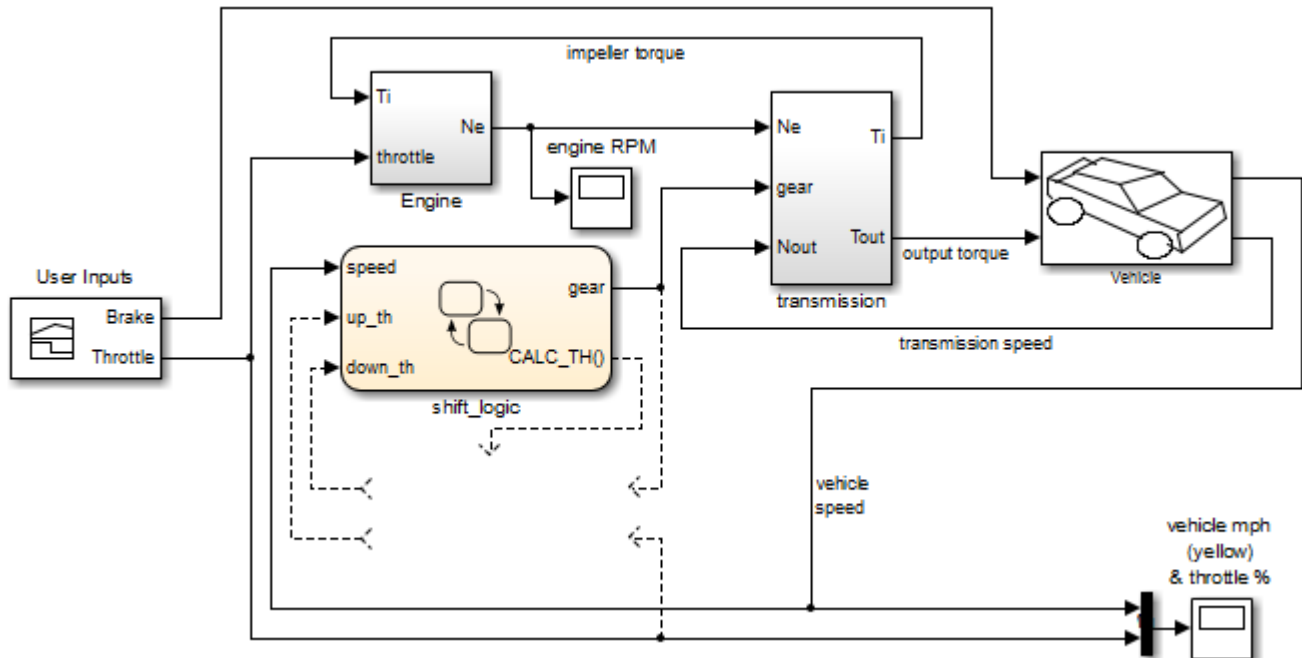

- 2 Open the shift_logic chart.
- 3 In the chart, right-click below selection_state and select **Paste** from the context menu.
- 4 Expand the new Simulink function so that the signature fits inside the function box.

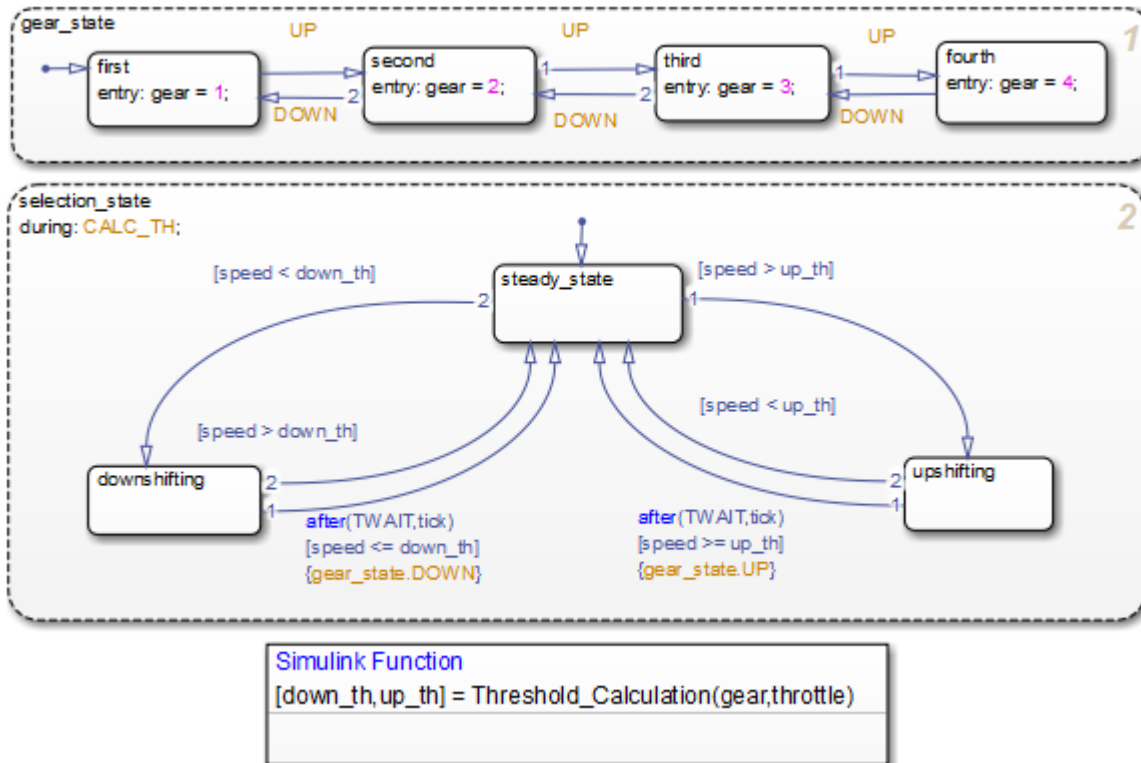

Tip To change the font size of a function, right-click the function box and select a new size from the **Font Size** menu.

- Expand the border of `selection_state` to include the new function.

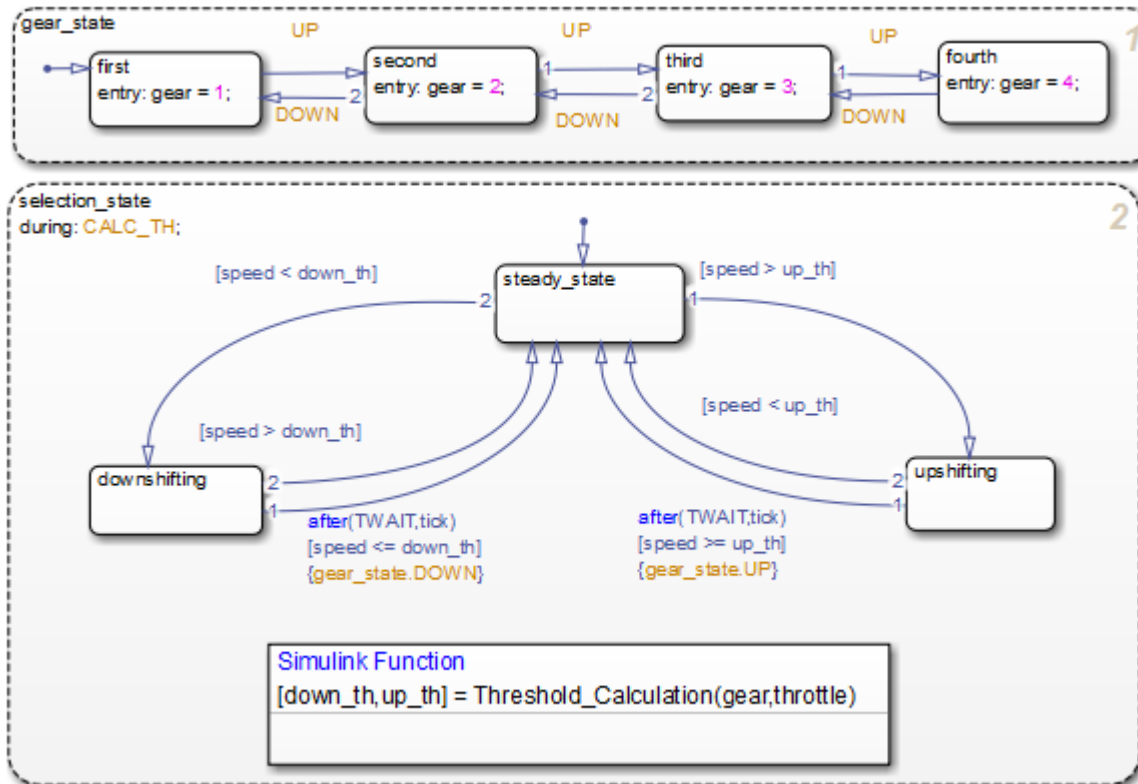

Note The function resides in this state instead of the chart level because no other state in the chart requires the function outputs `up_th` and `down_th`. See “Bind a Simulink Function to a State” on page 30-15.

- Rename the Simulink function from `Threshold_Calculation` to `calc_threshold` by entering `[down_th, up_th] = calc_threshold(gear, throttle)` in the function box.

Change the Scope of Chart Data

In the Model Explorer, change the scope of chart-level data `up_th` and `down_th` to `Local` because calculations for those data now occur inside the chart.

Update State Action in the Chart

In the Stateflow Editor, change the during action in `selection_state` to call the Simulink function `calc_threshold`.

```
during: [down_th, up_th] = calc_threshold(gear, throttle);
```

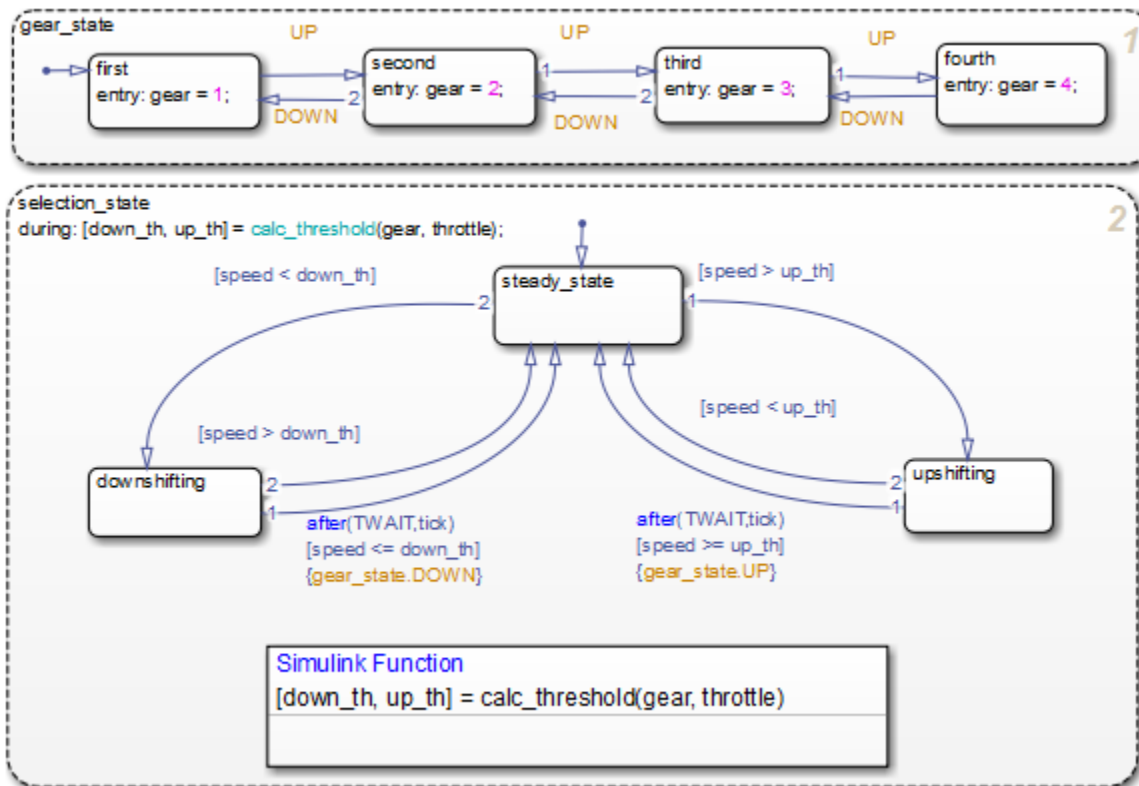

Add Data to the Chart

Because the function `calc_threshold` takes `throttle` as an input, you must define that data as a chart input. (For details, see “Add Stateflow Data” on page 9-2.)

- 1 Add input data `throttle` to the chart with a **Port** property of 1.

Using port 1 prevents signal lines from overlapping in the Simulink model.

- 2 In the Simulink model, add a signal line for `throttle` between the inport of the Engine block and the inport of the shift_logic chart.

Remove Unused Items in the Model

- 1 In the Model Explorer, delete the function-call output event `CALC_TH` because the Threshold Calculation block no longer exists.
- 2 Delete any dashed signal lines from your model.

Run the New Model

Your new model looks something like this:

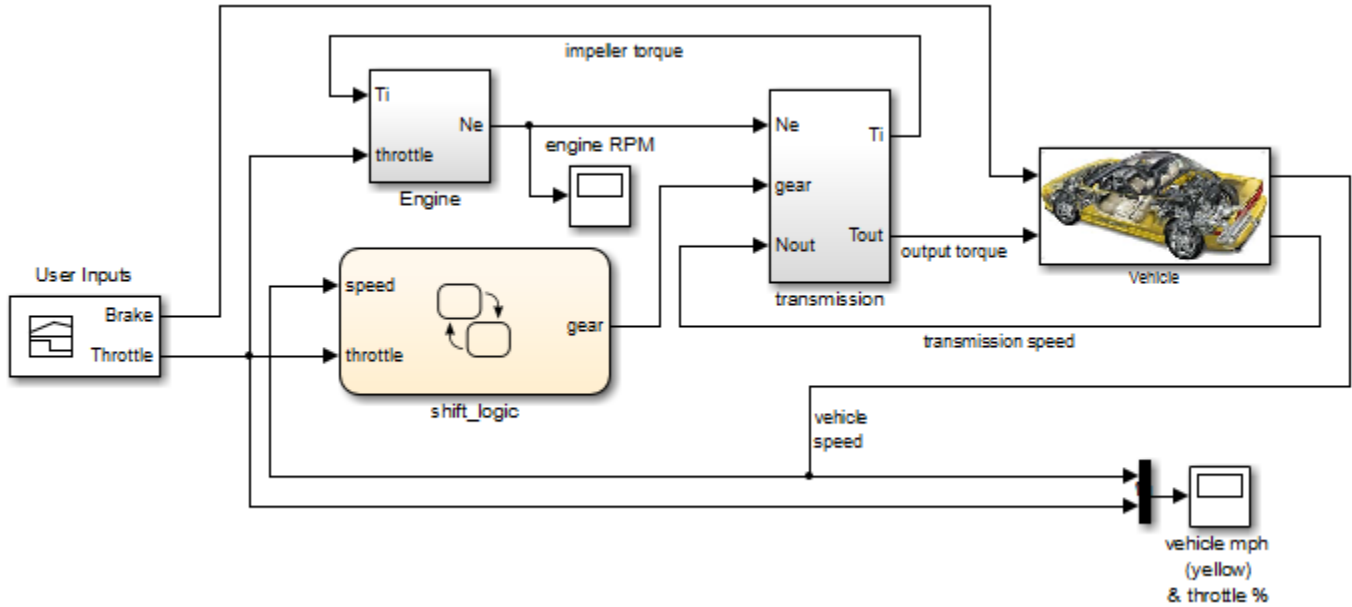

If you simulate the new model, the results match those of the original design.

See Also

More About

- “Reuse Simulink Components in Stateflow Charts” on page 30-2
- “Define a Simulink Function in a Stateflow Chart” on page 30-13

Schedule Execution of Multiple Controllers

A Simulink function is a graphical object that you fill with Simulink blocks and call in the actions of states and transitions. Simulink functions are supported only in Stateflow charts in Simulink models. For more information, see “Reuse Simulink Components in Stateflow Charts” on page 30-2.

Goal of the Tutorial

The goal of this tutorial is to use Simulink functions in a Stateflow chart to improve the design of a model named `sf_temporal_logic_scheduler`.

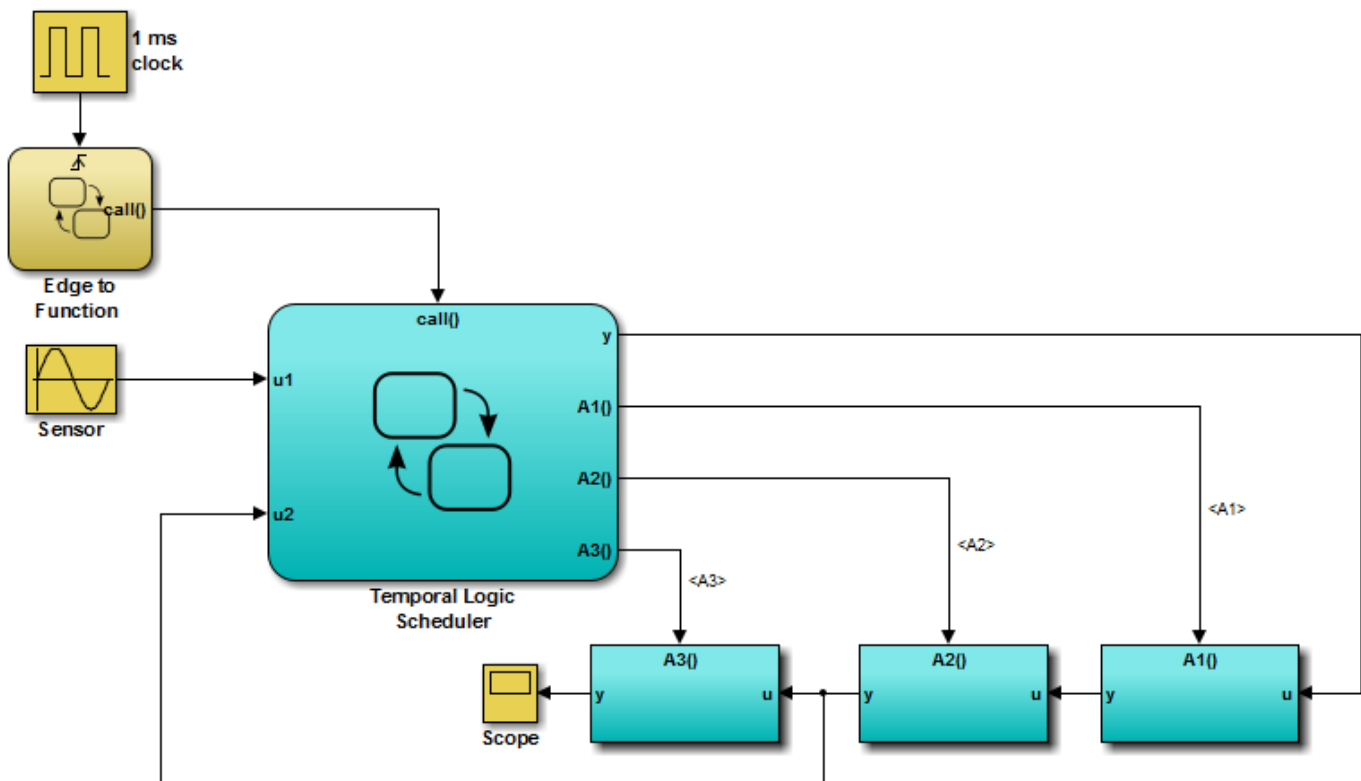

Rationale for Improving the Model Design

The `sf_temporal_logic_scheduler` model contains a Stateflow chart and three function-call subsystems. These blocks interact as follows:

- The chart broadcasts the output events A1, A2, and A3 to trigger the function-call subsystems.
- The subsystems A1, A2, and A3 execute at different rates defined by the chart.
- The subsystem outputs feed directly into the chart.

No other blocks in the model access the subsystem outputs.

You can replace function-call subsystems with Simulink functions inside a chart when:

- The subsystems perform calculations required by the chart.

- Other blocks in the model do not need access to the subsystem outputs.

Edit a Model to Use Simulink Functions

The sections that follow describe how to replace function-call subsystem blocks in a Simulink model with Simulink functions in a Stateflow chart. This procedure reduces the number of objects in the model while retaining the same simulation results.

Step	Task	Reference
1	Open the model.	"Open the Model" on page 30-29
2	Move the contents of the function-call subsystems into Simulink functions in the chart.	"Add Simulink Functions to the Chart" on page 30-30
3	Change the scope of specific chart-level data to <code>Local</code> .	"Change the Scope of Chart Data" on page 30-32
4	Replace event broadcasts with function calls.	"Update State Actions in the Chart" on page 30-32
5	Verify that function inputs and outputs are defined.	"Add Data to the Chart" on page 30-33
6	Remove unused items in the model.	"Remove Unused Items in the Model" on page 30-33

Note To skip the conversion steps, you can access the new model directly.

Open the Model

Open the `sf_temporal_logic_scheduler` model. If you simulate the model, you see this result in the scope.

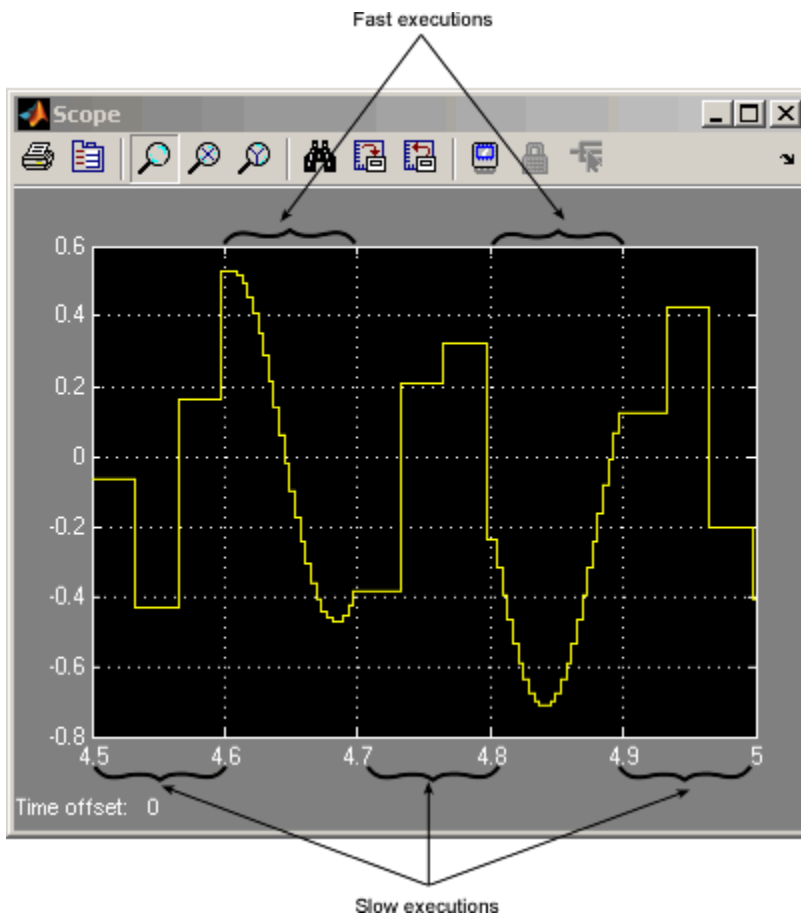

For more information, see “Schedule Subsystems to Execute at Specific Times” on page 27-17.

Add Simulink Functions to the Chart

Follow these steps to add Simulink functions to the Temporal Logic Scheduler chart.

- 1 In the Simulink model, right-click the A1 block in the lower right corner and select **Cut** from the context menu.

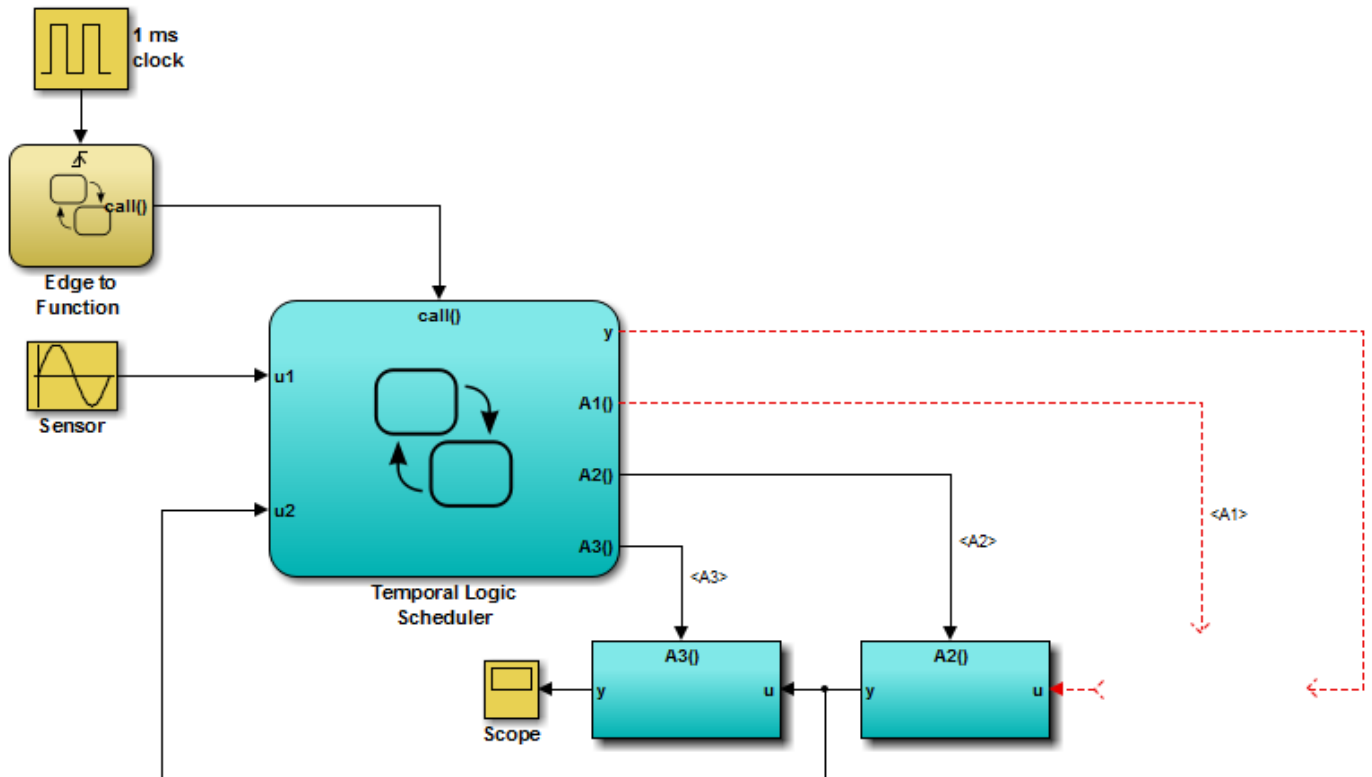

- 2 Open the Temporal Logic Scheduler chart.
- 3 In the chart, right-click outside any states and select **Paste** from the context menu.
- 4 Expand the new Simulink function so that the signature fits inside the function box.

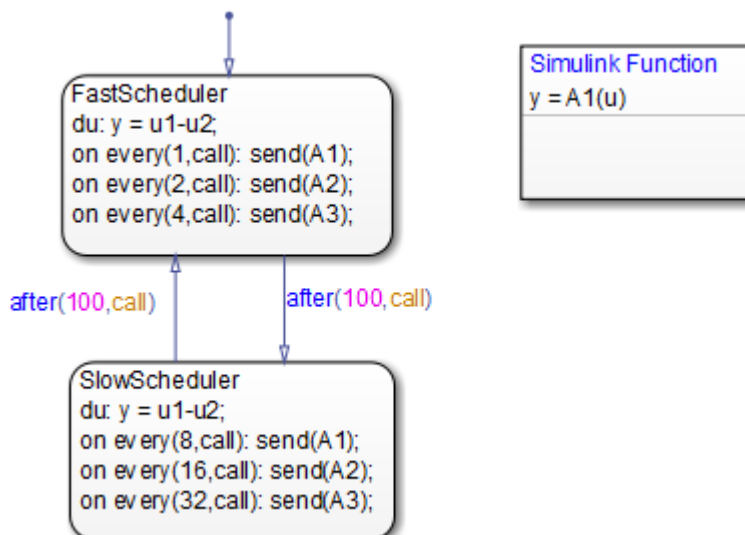

Tip To change the font size of a function, right-click the function box and select a new size from the **Font Size** menu.

- 5 Rename the Simulink function from A1 to f1 by entering $y = f1(u)$ in the function box.
- 6 Repeat steps 1 through 5 for these cases:
 - Copying the contents of A2 into a Simulink function named f2.
 - Copying the contents of A3 into a Simulink function named f3.

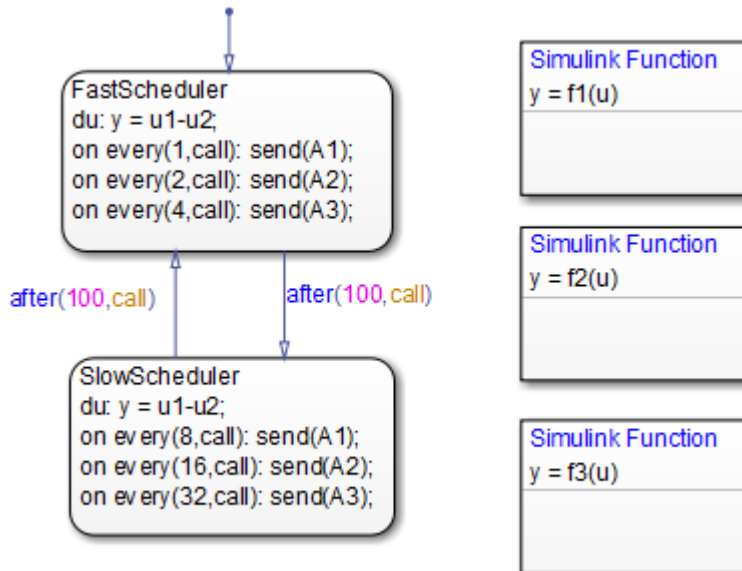

Note The new functions reside at the chart level because both states `FastScheduler` and `SlowScheduler` require access to the function outputs.

Change the Scope of Chart Data

In the Model Explorer, change the scope of chart-level data `y` to `Local` because the calculation for that data now occurs inside the chart.

Update State Actions in the Chart

In the Stateflow Editor, you can replace event broadcasts in state actions with function calls.

- 1 Edit the state actions in `FastScheduler` and `SlowScheduler` to call the Simulink functions `f1`, `f2`, and `f3`.

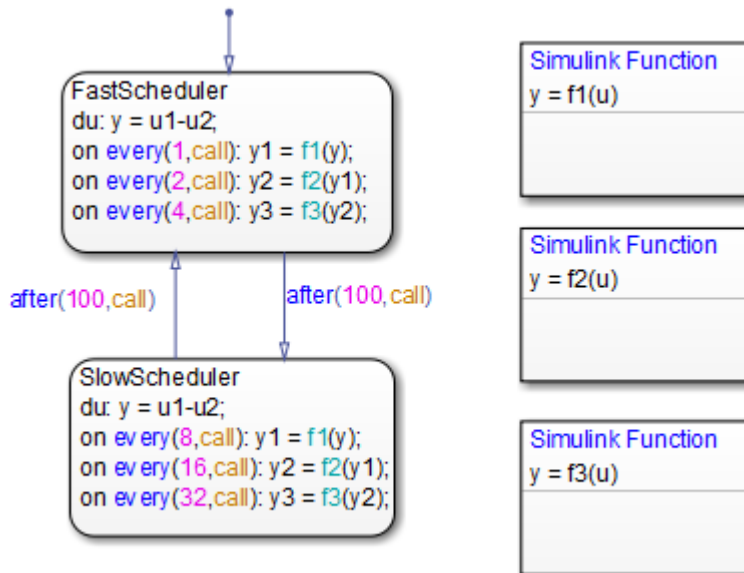

- 2 In both states, update each during action as follows.

du: $y = u1 - y2$;

Add Data to the Chart

For the on every state actions of FastScheduler and SlowScheduler, define three data. (For details, see “Add Stateflow Data” on page 9-2.)

- 1 Add local data y1 and y2 to the chart.
- 2 Add output data y3 to the chart.
- 3 In the model, connect the output for y3 to the input of the scope.

Tip To flip the Scope block, right-click and select **Rotate & Flip > Flip Block** from the context menu.

Remove Unused Items in the Model

- 1 In the Model Explorer, delete output events A1, A2, and A3 and input data u2 because the function-call subsystems no longer exist.
- 2 Delete any dashed signal lines from your model.

Run the New Model

Your new model looks something like this:

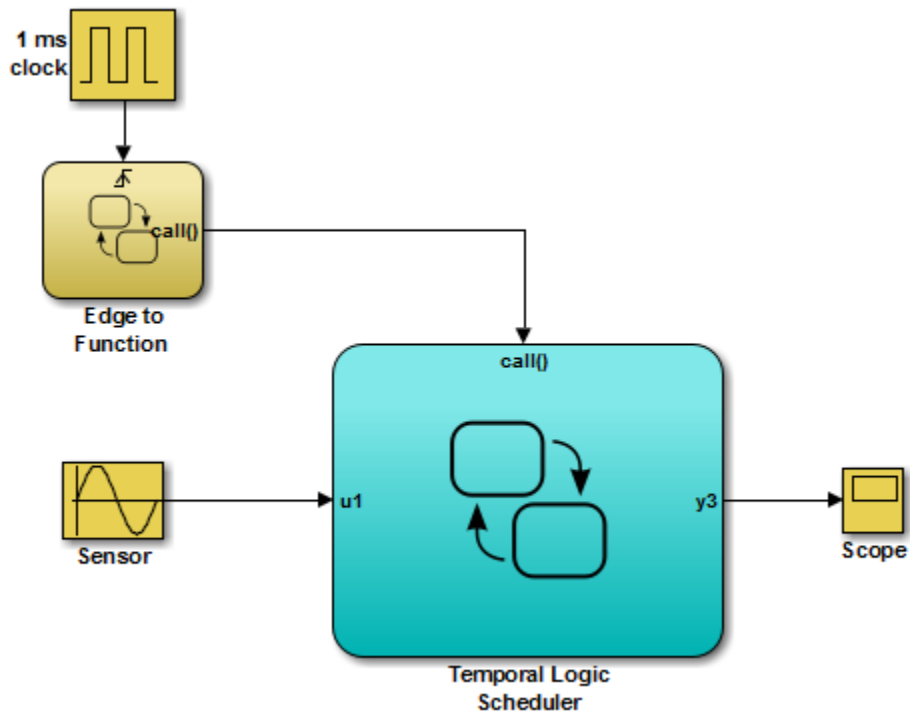

If you simulate the new model, the results match those of the original design.

See Also

More About

- “Reuse Simulink Components in Stateflow Charts” on page 30-2
- “Define a Simulink Function in a Stateflow Chart” on page 30-13

Build Targets

- “Access Custom C++ Code in Stateflow Charts” on page 31-2
- “Access Custom C Code in Nonlibrary Charts” on page 31-4
- “Access Custom C Code in Library Charts” on page 31-7
- “Access Custom C Code in All Charts in Model” on page 31-9
- “Access Custom Code Variables and Functions in Stateflow Charts” on page 31-11
- “Speed Up Simulation” on page 31-13
- “Command-Line API to Set Simulation and Code Generation Parameters” on page 31-15
- “Specify Relative Paths to Your Custom Code” on page 31-18
- “Reuse Custom Code in Stateflow Charts” on page 31-19
- “Resolve Undefined Symbols in Your Chart” on page 31-24
- “Call Extrinsic MATLAB Functions in Stateflow Charts” on page 31-26

Access Custom C++ Code in Stateflow Charts

You can integrate custom code written in C or C++ with Stateflow charts in Simulink models. By sharing data and functions between your custom code and your Stateflow chart, you can augment the capabilities of Stateflow and leverage the software to take advantage of your preexisting code. For more information, see “Reuse Custom Code in Stateflow Charts” on page 31-19.

Task 1: Prepare Code Files

Prepare your custom C++ code for simulation as follows:

- 1 Add a C function wrapper to your custom code. This wrapper function executes the C++ code that you are including.

The C function wrapper should have this form:

```
int my_c_function_wrapper()
{
    .
    .
    .
    //C++ code
    .
    .
    .
    return result;
}
```

- 2 Create a header file that prototypes the C function wrapper in the previous step.

The header file should have this form:

```
int my_c_function_wrapper();
```

The value `_cplusplus` exists if your compiler supports C++ code. The `extern "C"` wrapper specifies C linkage with no name mangling.

Task 2: Include Custom C++ Source and Header Files for Simulation

To include custom C++ code for simulation, you must configure your simulation target and select C++ as the custom code language:

- 1 Open the Model Configuration Parameters dialog box.
- 2 In the Model Configuration Parameters dialog box, select the **Simulation Target** pane.
- 3 Add your custom header file in the **Header file** subpane. Click **Apply**.
- 4 Add your custom C++ files in the **Source files** subpane. Click **Apply**.
- 5 In the Model Configuration Parameters dialog box, select the **Code Generation** pane.
- 6 Select C++ from the **Language** menu.
- 7 Click **OK**.

Task 3: Choose a C++ Compiler

You can change the default compiler by calling the `mex -setup` command, and following the instructions. For a list of supported compilers, see www.mathworks.com/support/compilers/current_release/.

Task 4: Simulate the Model

Simulate your model by clicking the play button in the toolbar of the editor.

For information on setting simulation options using the command-line API, see “Command-Line API to Set Simulation and Code Generation Parameters” on page 31-15.

See Also

More About

- “Reuse Custom Code in Stateflow Charts” on page 31-19
- “C++ Code Generation and Integration in Stateflow”

Access Custom C Code in Nonlibrary Charts

You can integrate custom code written in C or C++ with Stateflow charts in Simulink models. By sharing data and functions between your custom code and your Stateflow chart, you can augment the capabilities of Stateflow and leverage the software to take advantage of your preexisting code. For more information, see “Reuse Custom Code in Stateflow Charts” on page 31-19.

Task 1: Include Custom C Code in the Simulation Target

Specify custom code options in the simulation target for your model:

- 1 Open the Model Configuration Parameters dialog box.
- 2 In the Model Configuration Parameters dialog box, select the **Simulation Target** pane.

The custom code options appear.

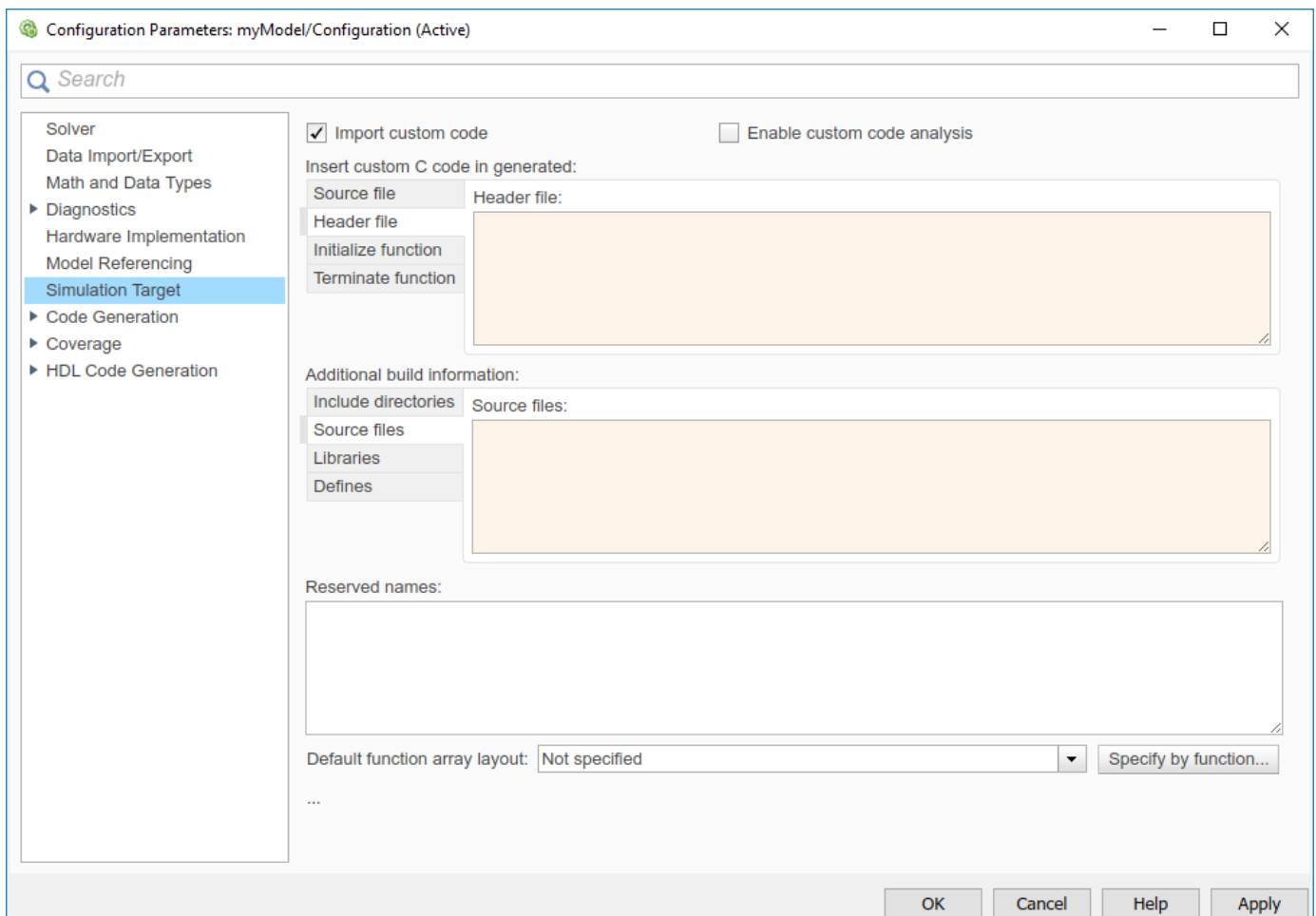

- 3 Specify your custom code in the subpanes.

Follow the guidelines in “Specify Relative Paths to Your Custom Code” on page 31-18.

- **Source file** — Enter code lines to include at the top of a generated source code file. These code lines appear at the top of the generated *model.c* source file, outside of any function.

For example, you can include `extern int` declarations for global variables.

- **Header file** — Enter code lines to include at the top of the generated `model.h` header file that declares custom functions and data in the generated code. These code lines appear at the top of all generated source code files and are visible to all generated code.

Note When you include a custom header file, you must enclose the file name in double quotes. For example, `#include "sample_header.h"` is a valid declaration for a custom header file.

Since the code you specify in this option appears in multiple source files that link into a single binary, limitations exist on what you can include. For example, do not include a global variable definition such as `int x;` or a function body such as

```
void myfun(void)
{
...
}
```

These code lines cause linking errors because their symbol definitions appear multiple times in the source files of the generated code. You can, however, include `extern` declarations of variables or functions such as `extern int x;` or `extern void myfun(void);`.

- **Initialize function** — Enter code statements that execute once at the start of simulation. Use this code to invoke functions that allocate memory or perform other initializations of your custom code.
- **Terminate function** — Enter code statements that execute at the end of simulation. Use this code to invoke functions that free memory allocated by the custom code or perform other cleanup tasks.
- **Include directories** — Enter a space-separated list of the folder paths that contain custom header files that you include either directly (see **Header file** option) or indirectly in the compiled target.
- **Source files** — Enter a list of source files to compile and link into the target. You can separate source files with a comma, a space, or a new line.
- **Libraries** — Enter a space-separated list of static libraries that contain custom object code to link into the target.

4 Click **OK**.

Task 2: Simulate the Model

Simulate your model by clicking the play button in the toolbar of the editor.

For information on setting simulation options using the command-line API, see “Command-Line API to Set Simulation and Code Generation Parameters” on page 31-15.

See Also

More About

- “Reuse Custom Code in Stateflow Charts” on page 31-19

- “Include Custom C Code Functions and Structures”
- “Share String Data with Custom C Code” on page 21-13
- “Integrate Custom Structures in Stateflow Charts” on page 26-10

Access Custom C Code in Library Charts

You can integrate custom code written in C or C++ with Stateflow charts in Simulink models. By sharing data and functions between your custom code and your Stateflow chart, you can augment the capabilities of Stateflow and leverage the software to take advantage of your preexisting code. For more information, see “Reuse Custom Code in Stateflow Charts” on page 31-19.

Task 1: Include Custom C Code in Simulation Targets for Library Models

Specify custom code options in the simulation target for each library model that contributes a chart to the main model:

- 1 In the **Modeling** tab, select **Model Settings**.

The Model Configuration Parameters dialog box appears. Open the **Simulation Target** pane.

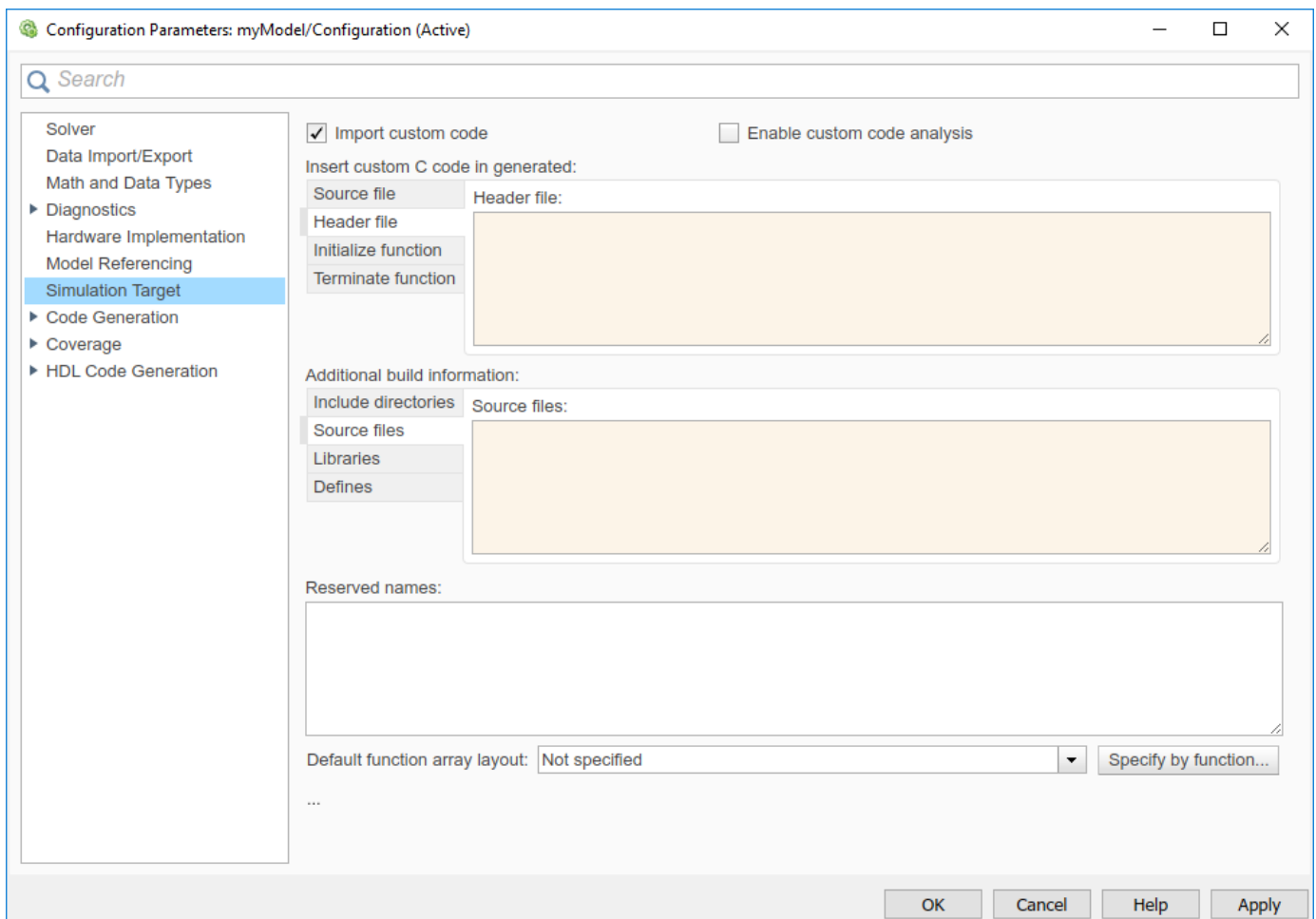

- 2 Select **Use local custom code settings (do not inherit from main model)**.

This step ensures that each library model retains its own custom code settings during simulation.

- 3 Specify your custom code in the subpanes.

Follow the guidelines in “Specify Relative Paths to Your Custom Code” on page 31-18.

Note See “Task 1: Include Custom C Code in the Simulation Target” on page 31-4 for descriptions of the custom code options.

- 4 Click **OK**.

Task 2: Simulate the Model

Simulate your model by clicking the play button in the toolbar of the editor.

For information on setting simulation options using the command-line API, see “Command-Line API to Set Simulation and Code Generation Parameters” on page 31-15.

Note You cannot simulate only the Stateflow blocks in a library model. You must first create a link to the library block in your main model and then simulate the main model.

See Also

More About

- “Reuse Custom Code in Stateflow Charts” on page 31-19
- “Include Custom C Code Functions and Structures”
- “Share String Data with Custom C Code” on page 21-13
- “Integrate Custom Structures in Stateflow Charts” on page 26-10

Access Custom C Code in All Charts in Model

You can integrate custom code written in C or C++ with Stateflow charts in Simulink models. By sharing data and functions between your custom code and your Stateflow chart, you can augment the capabilities of Stateflow and leverage the software to take advantage of your preexisting code. For more information, see “Reuse Custom Code in Stateflow Charts” on page 31-19.

To integrate custom C code that applies to all charts for simulation, perform the tasks that follow.

Task 1: Include Custom C Code in the Simulation Target for the Main Model

Specify custom code options in the simulation target for your main model:

- 1 Open the Model Configuration Parameters dialog box.
- 2 In the Model Configuration Parameters dialog box, select the **Simulation Target** pane.

The custom code options appear.

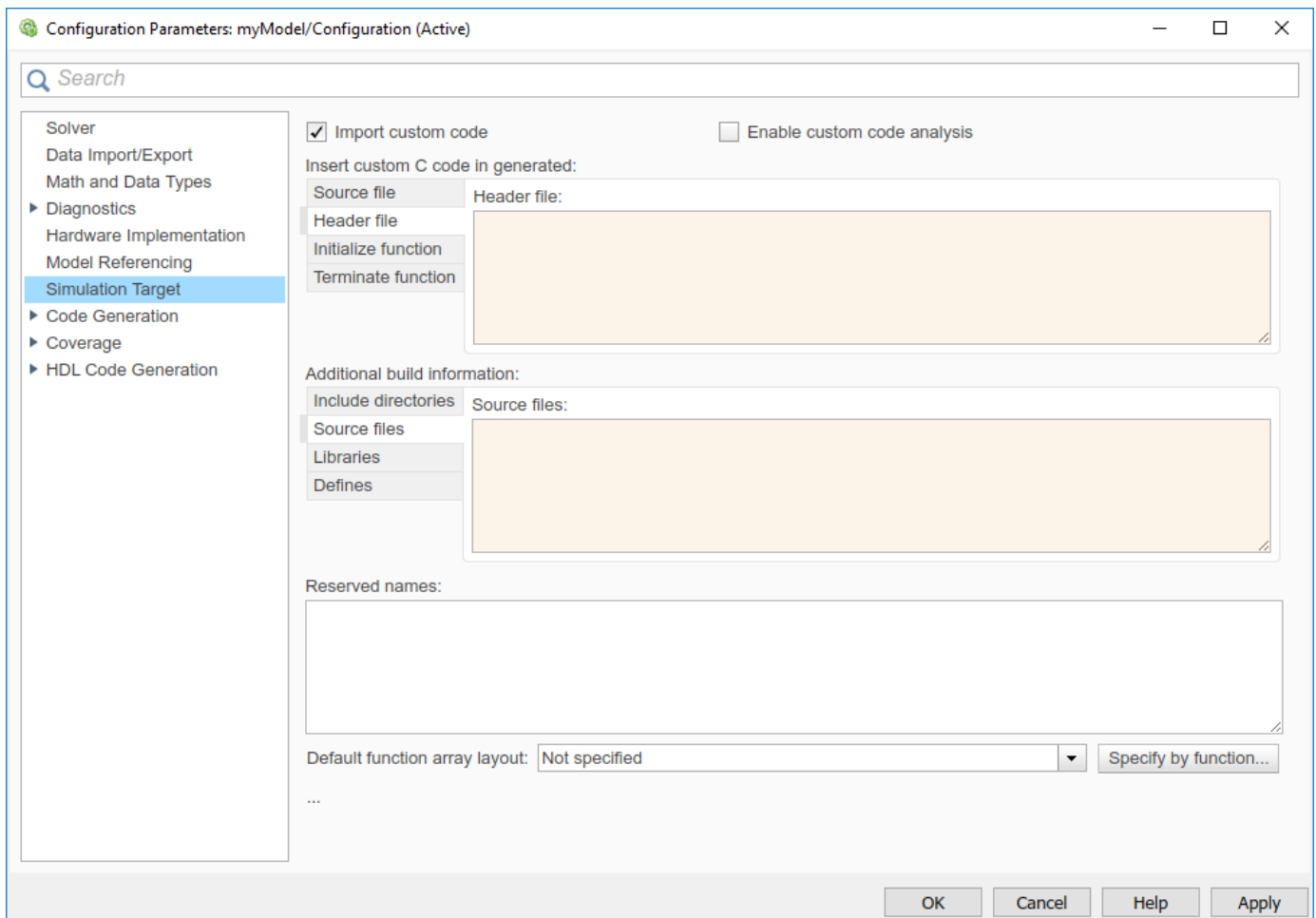

- 3 Specify your custom code in the subpanes.

Follow the guidelines in “Specify Relative Paths to Your Custom Code” on page 31-18.

Note See “Task 1: Include Custom C Code in the Simulation Target” on page 31-4 for descriptions of the custom code options.

- 4 Click **OK**.

By default, settings in the **Simulation Target** pane for the main model apply to all charts contributed by library models.

Tip If you want to rebuild the target to include custom code changes, in the **Apps** tab, select **Simulink Coder**. The **C Code** tab appears. Click **Build**.

Task 2: Ensure That Custom C Code for the Main Model Applies to Library Charts

Configure the simulation target for each library model that contributes a chart to your main model:

- 1 In the **Modeling** tab, select **Model Settings**. Open the **Simulation Target** pane.
- 2 Clear the **Use local custom code settings (do not inherit from main model)** check box.

This step ensures that library charts inherit the custom code settings of your main model.

- 3 Click **OK**.

Task 3: Simulate the Model

Simulate your model by clicking the play button in the toolbar of the editor.

For information on setting simulation options using the command-line API, see “Command-Line API to Set Simulation and Code Generation Parameters” on page 31-15.

See Also

More About

- “Reuse Custom Code in Stateflow Charts” on page 31-19
- “Include Custom C Code Functions and Structures”
- “Share String Data with Custom C Code” on page 21-13
- “Integrate Custom Structures in Stateflow Charts” on page 26-10

Access Custom Code Variables and Functions in Stateflow Charts

You can integrate custom code written in C or C++ with Stateflow charts in Simulink models. By sharing data and functions between your custom code and your Stateflow chart, you can augment the capabilities of Stateflow and leverage the software to take advantage of your preexisting code. For more information, see “Reuse Custom Code in Stateflow Charts” on page 31-19.

Custom Code Variables in Charts That Use MATLAB as the Action Language

You can read and write the following C code variables directly in your charts that use MATLAB as the action language.

Custom C Code Type	Description
double	Double-precision floating point
single	Single-precision floating point
int8	Signed 8-bit integer
uint8	Unsigned 8-bit integer
int16	Signed 16-bit integer
uint16	Unsigned 16-bit integer
int32	Signed 32-bit integer
uint32	Unsigned 32-bit integer

By right clicking on the Stateflow object that uses your custom code, you can access your custom code variable. After right clicking on the object, hover over **Explore**. Your custom code variable appears, denoted by (C variable). Clicking the C variable allows you to access the custom code from MATLAB.

Custom Code Functions in Charts That Use MATLAB as the Action Language

You can use the following C function argument types directly in your charts that use MATLAB as the action language without using `coder.ceval`. For information on calling external code from MATLAB code by using `coder.ceval`, see “Call C/C++ Code from MATLAB Code” (MATLAB Coder).

Custom C Function Argument Type	Description
double	Double-precision floating point
single	Single-precision floating point
int8	Signed 8-bit integer
uint8	Unsigned 8-bit integer
int16	Signed 16-bit integer
uint16	Unsigned 16-bit integer

Custom C Function Argument Type	Description
int32	Signed 32-bit integer
uint32	Unsigned 32-bit integer

By right clicking on the Stateflow object that uses your custom code, you can access your custom code function. After right clicking on the object, hover over **Explore**. Your custom code function appears, denoted by (C function). Clicking the C function allows you to access the custom code from MATLAB.

See Also

More About

- “Reuse Custom Code in Stateflow Charts” on page 31-19
- “Specify Relative Paths to Your Custom Code” on page 31-18

Speed Up Simulation

Improve Model Update Performance

Stateflow uses Just-In-Time (JIT) compilation mode to improve model update performance for most charts in Simulink models. Stateflow applies JIT mode to charts that qualify. For a chart in JIT mode, Stateflow generates an execution engine in memory for simulation. For these charts, Stateflow does not generate C code or a MEX file to simulate the chart. JIT mode provides the best performance during the compilation of a model.

Some charts do not qualify for JIT mode, such as charts with signal logging.

Stateflow models include debugging support for simulation. To gain optimal performance, turn off debugging by using this command:

```
sfc('coder_options', 'forceDebugOff', 1);
```

When you run this command, your Stateflow charts do not have debugging support or run-time error checking.

Note When you turn off debugging, animation is also turned off.

Disable Simulation Target Options That Impact Execution Speed

To simulate your model more quickly, in the Model Configuration Parameters dialog box, on the **Simulation Target** pane, clear the check boxes for these parameters:

- **Echo expressions without semicolons** — To disable run-time output in the MATLAB Command Window, such as actions that do not terminate with a semicolon, clear this check box.
- **Ensure responsiveness**— To disable ability to break out of long-running execution using Ctrl+C, clear this check box.

Click **OK**.

Speed Up Simulation

Use these tips to further speed up simulation:

Keep Charts Closed

During model simulation, any open charts with animation enabled take longer to simulate. If you keep all charts closed, the simulation runs faster.

Disable Content Preview

During model simulation, any open charts with content preview enabled take longer to simulate. If you disable content preview, the simulation runs faster. To disable content preview, select the chart that has content preview enabled. On the **State Chart** tab, click **Content Preview**.

Keep Scope Blocks

During model simulation, any open Scope blocks continuously update their display. If you keep all Scope blocks closed, you can speed up the simulation. After the simulation ends, you can open the Scope blocks to view the results.

Use Library Charts in Your Model

If your model contains multiple charts that do not use JIT mode and contain the same elements, you might generate multiple copies of identical simulation code. By using library charts, you can minimize the number of copies of identical simulation code. For example, using five library charts reduces the number of identical copies from five to one.

For more information, see “Create Specialized Chart Libraries for Large-Scale Modeling” on page 25-12.

See Also**More About**

- “Reduce the Compilation Time of a Chart” on page 16-29

Command-Line API to Set Simulation and Code Generation Parameters

In Stateflow charts in Simulink models, you can use the command-line API to set options in the Model Configuration Parameters dialog box for simulation and embeddable code generation, .

Set Parameters at the Command Line

- 1 At the MATLAB command prompt, type:

```
object_name = getActiveConfigSet(gcs)
```

This command returns an object handle to the model settings in the Model Configuration Parameters dialog box for the current model.

- 2 To set a parameter for that dialog box, type:

```
object_name.set_param('parameter_name', value)
```

This command sets a configuration parameter to the value that you specify.

For example, you can set the **Reserved names** parameter for simulation by typing:

```
cp = getActiveConfigSet(gcs)
cp.set_param('SimReservedNameArray', {'abc', 'xyz'})
```

Note You can also get the current value of a configuration parameter by typing:

```
object_name.get_param('parameter_name')
```

For more information about using `get_param` and `set_param`, see the Simulink documentation.

Simulation Parameters for Nonlibrary Models

The following table summarizes the parameters and values that you can set for simulation of nonlibrary models using the command-line API.

Parameter and Values	Dialog Box Equivalent	Description
SimIntegrity - 'off', 'on'	Ensure memory integrity	Detect violations of memory integrity in code generated for MATLAB Function blocks and stop execution with a diagnostic.
SFSimEcho - 'off', 'on'	Echo expressions without semicolons	Enable run-time output to appear in the MATLAB Command Window during simulation.
SimCtrlC - 'off', 'on'	Ensure responsiveness	Enable responsiveness checks in code generated for MATLAB Function blocks.

Parameter and Values	Dialog Box Equivalent	Description
SimBuildMode - 'sf_incremental_build', 'sf_nonincremental_build', 'sf_make', 'sf_make_clean', 'sf_make_clean_objects'	Simulation target build mode	Specify how you build the simulation target for a model.
SimReservedNameArray <i>string array - {}</i>	Symbols > Reserved names	Enter the names of variables or functions in the generated code that match the names of variables or functions specified in custom code to avoid naming conflicts.
SimParseCustomCode - 'off', 'on'	Import custom code	Specify whether or not to parse the custom code and report unresolved symbols for the C charts in a model.
SimCustomSourceCode <i>string - ''</i>	Source file	Enter code lines to appear near the top of a generated source code file.
SimCustomHeaderCode <i>string - ''</i>	Header file	Enter code lines to appear near the top of a generated header file.
SimCustomInitializer <i>string - ''</i>	Initialize function	Enter code statements that execute once at the start of simulation.
SimCustomTerminator <i>string - ''</i>	Terminate function	Enter code statements that execute at the end of simulation.
SimUserIncludeDirs <i>string - ''</i>	Include directories	Enter a space-separated list of folder paths that contain files you include in the compiled target. Note If your list includes any Windows® paths that contain spaces, each instance must be enclosed in double quotes within the argument, for example, 'C:\Project "C:\Custom Files"'
SimUserSources <i>string - ''</i>	Source files	Enter a space-separated list of source files to compile and link into the target.
SimUserLibraries <i>string - ''</i>	Libraries	Enter a space-separated list of static libraries that contain custom object code to link into the target.

Simulation Parameters for Library Models

The following table summarizes the simulation parameters that apply to library models.

Parameter and Values	Dialog Box Equivalent	Description
SimUseLocalCustomCode - 'off', 'on'	Use local custom code settings (do not inherit from main model)	Specify whether a library model can use custom code settings that are unique from the main model to which the library is linked.
SimCustomSourceCode <i>string</i> - ''	Source file	Enter code lines to appear near the top of a generated source code file.
SimCustomHeaderCode <i>string</i> - ''	Header file	Enter code lines to appear near the top of a generated header file.
SimCustomInitializer <i>string</i> - ''	Initialize function	Enter code statements that execute once at the start of simulation.
SimCustomTerminator <i>string</i> - ''	Terminate function	Enter code statements that execute at the end of simulation.
SimUserIncludeDirs <i>string</i> - ''	Include directories	<p>Enter a space-separated list of folder paths that contain files you include in the compiled target.</p> <p>Note If your list includes any Windows paths that contain spaces, each instance must be enclosed in double quotes within the argument, for example,</p> <p>'C:\Project "C:\Custom Files"'</p>
SimUserSources <i>string</i> - ''	Source files	Enter a space-separated list of source files to compile and link into the target.
SimUserLibraries <i>string</i> - ''	Libraries	Enter a space-separated list of static libraries that contain custom object code to link into the target.

See Also

More About

- “Recommended Settings Summary for Model Configuration Parameters” (Simulink Coder)

Specify Relative Paths to Your Custom Code

You can integrate custom code written in C or C++ with Stateflow charts in Simulink models. By sharing data and functions between your custom code and your Stateflow chart, you can augment the capabilities of Stateflow and leverage the software to take advantage of your preexisting code. For more information, see “Reuse Custom Code in Stateflow Charts” on page 31-19.

Why Use Relative Paths?

If you specify paths and files with absolute paths and later move them, you must change these paths to point to new locations. To avoid this problem, use relative paths for custom code options that specify paths or files.

Search Relative Paths

Search paths exist relative to these folders:

- The current folder
- The model folder (if different from the current folder)
- The custom list of folders that you specify
- All the folders on the MATLAB search path, excluding the toolbox folders

Path Syntax Rules

When you construct relative paths for custom code, follow these syntax rules:

- You can use the forward slash (/) or backward slash (\) as a file separator, regardless of whether you are on a UNIX® or PC platform. The makefile generator returns the path names with the correct platform-specific file separators.
- You can use tokens that evaluate in the MATLAB workspace, if you enclose them with dollar signs (\$...\$). For example, consider this path:

```
$mydir1$dir1
```

In this example, `mydir1` is a variable that you define in the MATLAB workspace as `'d:\work\source\module1'`. In the generated code, this custom include path appears as:

```
d:\work\source\module1\dir1
```

- You must enclose paths in double quotes if they contain spaces or other nonstandard path characters, such as hyphens (-).

See Also

More About

- “Reuse Custom Code in Stateflow Charts” on page 31-19

Reuse Custom Code in Stateflow Charts

You can integrate custom code written in C or C++ with Stateflow charts in Simulink models. By sharing data and functions between your custom code and your Stateflow chart, you can augment the capabilities of Stateflow and leverage the software to take advantage of your preexisting code.

Stateflow charts call custom code functions by using the same syntax as other reusable functions:

```
return_val = function_name(arg1,arg2,...)
```

Note Do not share fixed-point data between your custom code and your Stateflow chart.

Choose the Appropriate Procedure for Simulation

To choose the right procedure for simulation, click the highlighted block that best describes your goal.



Use Custom Code to Define Global Constants

This example shows how to use custom C code to define constants that apply to all charts in your model.

The model contains a Stateflow® chart with an input, which you can set to 0 or 1 by toggling the manual switch in the model during simulation.

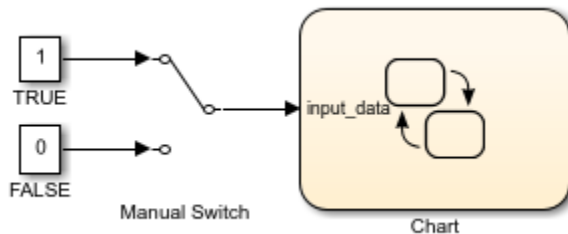

The chart contains two states A and B. In this example, you define two constants named TRUE and FALSE to guard the transitions between the states in the chart, instead of using the values 1 and 0. These custom definitions improve the readability of your chart actions. TRUE and FALSE are not Stateflow data objects.

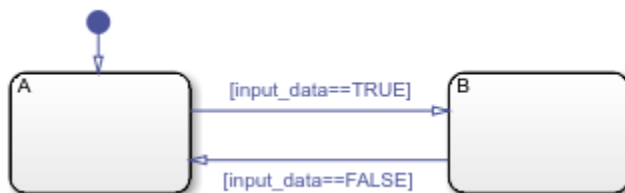

To enter the custom code that defines the two constants:

- 1 Open the Model Configuration Parameters dialog box.
- 2 Select the **Simulation Target** pane.
- 3 In the **Header file** subpane, enter `#define` and `#include` statements. For instance, in this example, you define the global constants with this code:

```
#define TRUE 1
#define FALSE 0
```

Because the two custom definitions appear at the top of the generated machine header file `sf_custom_code_global_constants_sf.h`, you can use `TRUE` and `FALSE` in all charts that belong to this model.

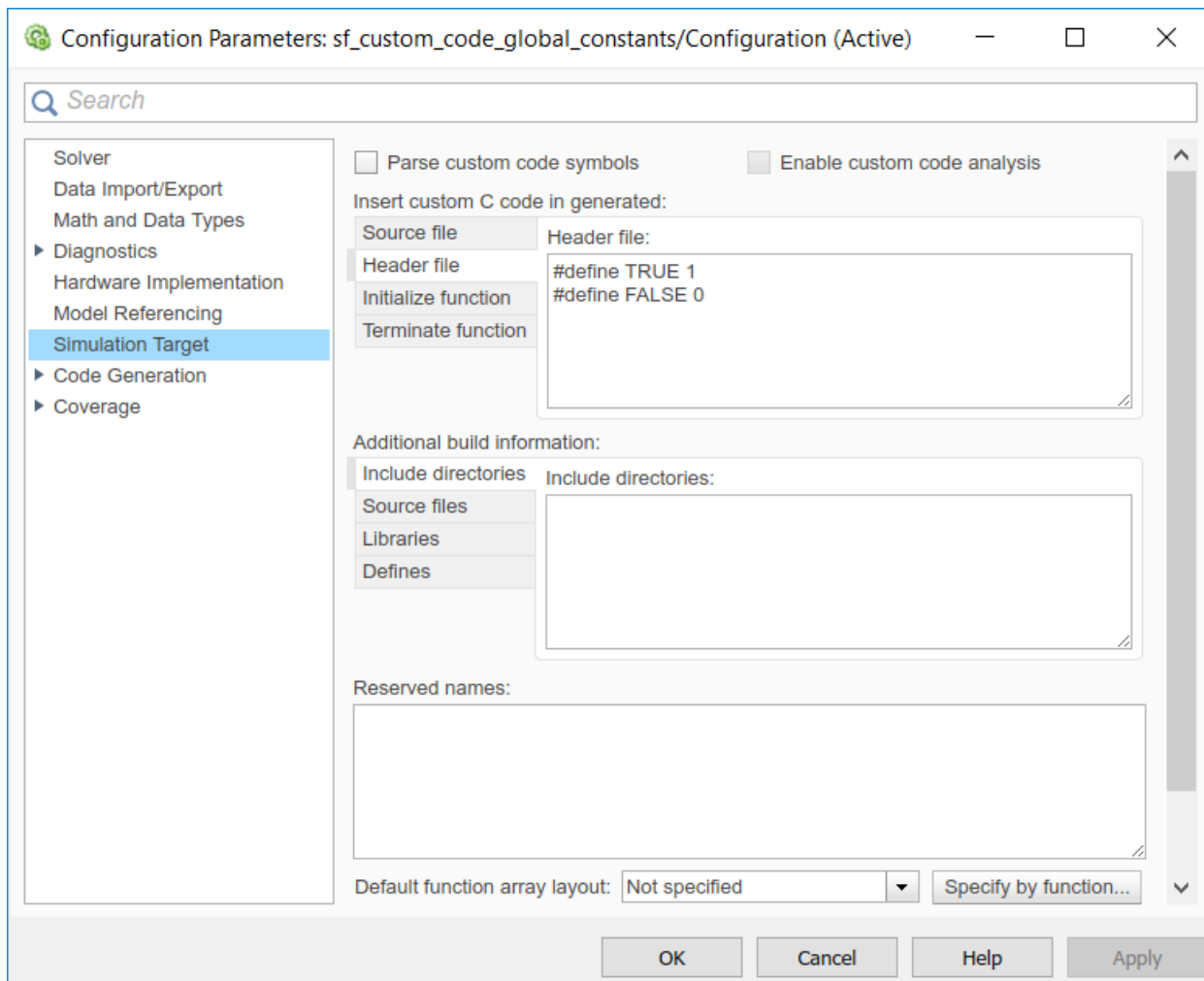

Use Custom Code to Define Constants, Variables, and Functions

This example shows how to use custom C code to define constants, variables, and functions that apply to all charts in your model.

The model contains a Stateflow chart with an input signal from a Sine Wave block.

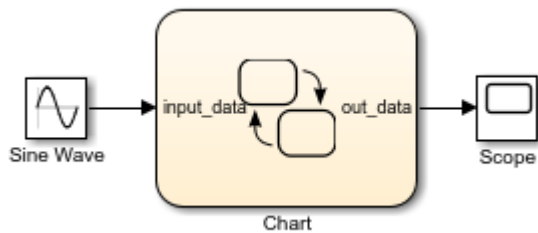

The chart contains two states A and B, and three data objects: `input_data`, `local_data`, and `out_data`. The chart accesses a custom variable named `my_global` and calls a custom function named `my_function`.

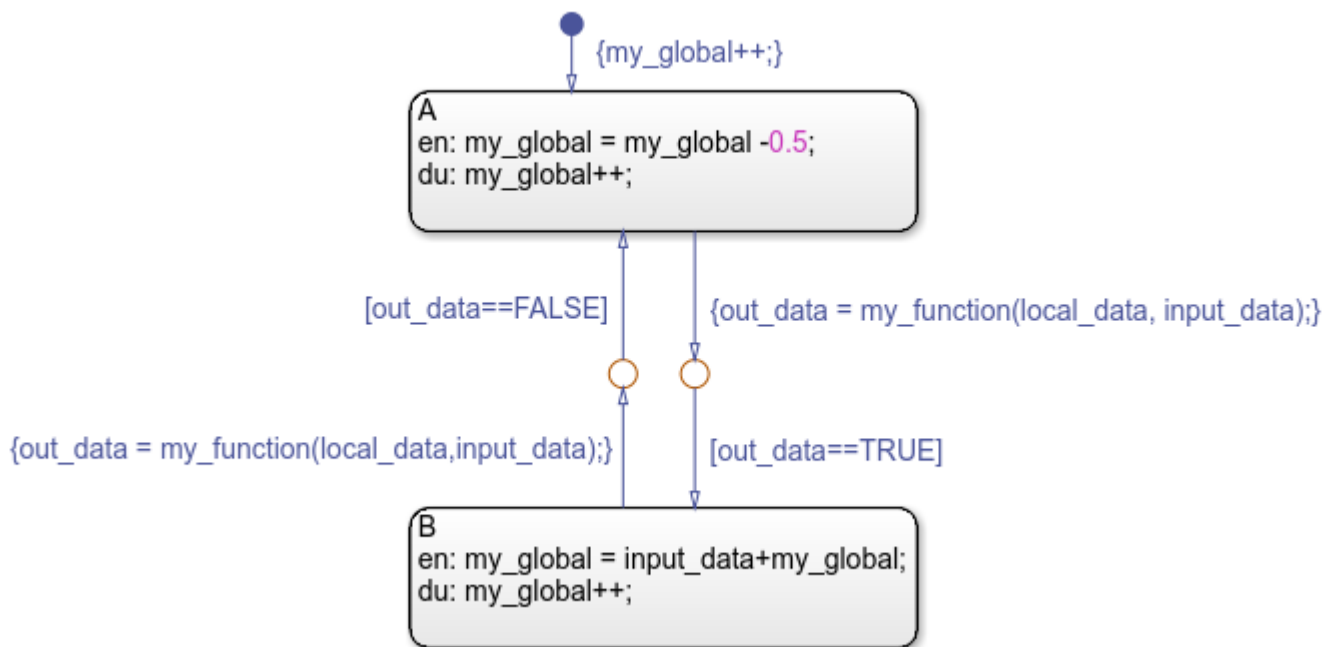

To configure the model to access the custom code:

- 1 Open the Model Configuration Parameters dialog box.
- 2 Select the **Simulation Target** pane.
- 3 In the **Header file** subpane, enter `#define` and `#include` statements. When you include a custom header file, you must enclose the file name in double quotes.
- 4 In the **Include directories** subpane, enter the name of the folder that contains your custom code files. To access custom code files in a subfolder of the model folder, use a relative path name of the form `.\subfolder_name`.
- 5 In the **Source files** subpane, enter the name of the source file that contains your custom code. To access a source file that resides in a subfolder of the model folder, use a relative path name of the form `.\subfolder_name\source_file.c`.

In this example, the custom code defines three constants, a variable, and a function by using these configurations:

- The **Header file** subpane contains this statement: `#include "sf_custom_code_constants_vars_fcns_hdr.h"`
- The **Include directories** subpane contains a single period (.) to indicate that all of the custom code files reside in the same folder as the model.
- The **Source file** subpane contains this file name: `sf_custom_code_constants_vars_fcns_src.c`

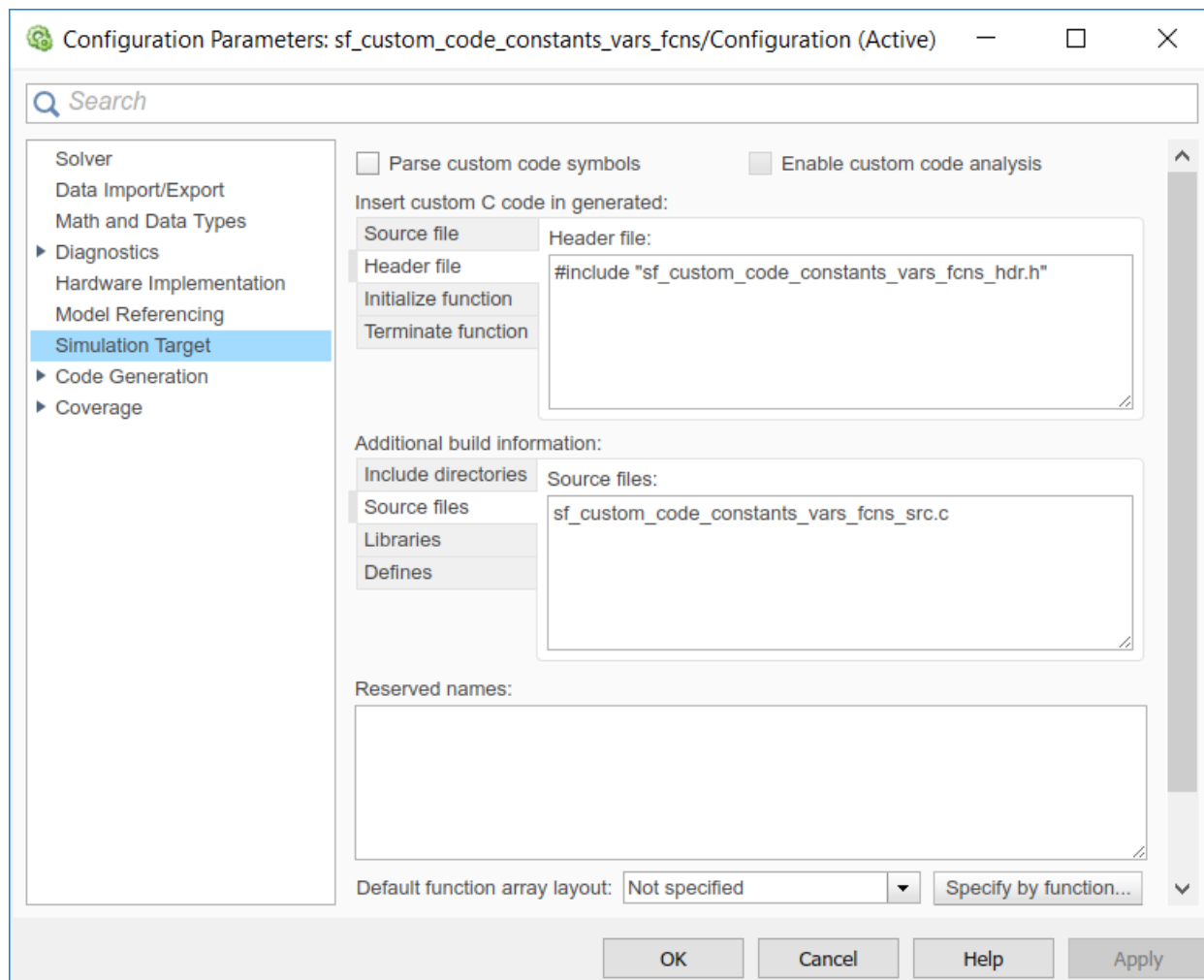

The custom header file `sf_custom_code_constants_vars_fcns_hdr.h` contains the definitions of three constants:

```
#define TRUE 1
#define FALSE 0
#define MAYBE 2
```

The header file also contains declarations for the variable `my_global` and the function `my_function`:

```
extern int myglobal;
extern int my_function(int var1, double var2);
```

The custom source file `sf_custom_code_constants_vars_fcns_src.c` is compiled in conjunction with the Stateflow generated code into a single S-function MEX file.

Because the custom definitions appear at the top of the generated machine header file `sf_custom_code_constants_vars_fcns_sfun.h`, you can access them in all charts that belong to this model.

See Also

More About

- “Access Custom C Code in Nonlibrary Charts” on page 31-4
- “Access Custom C Code in Library Charts” on page 31-7
- “Access Custom C Code in All Charts in Model” on page 31-9
- “Access Custom C++ Code in Stateflow Charts” on page 31-2

Resolve Undefined Symbols in Your Chart

Symbols that appear in your chart but that you have not added as data, events, or messages are undefined or unresolved. You can resolve undefined symbols by using the Symbols pane or the Symbol Wizard. For each undefined symbol, based on the symbol usage in the chart, Stateflow infers these properties:

- Class (data, event, or message)
- Scope
- Size
- Type
- Complexity

Resolve Symbols Through the Symbols Pane

As you edit your chart, Stateflow detects undefined symbols and marks them in the Symbols pane with a red error icon . For each undefined symbol, the **TYPE** column displays the class and scope inferred from the usage in the chart. You can resolve undefined symbols individually or collectively.

- To define a symbol with the inferred class and scope, click the error icon and select **Fix**.
- To define a symbol with a different class or scope, select another combination of class and scope from the **TYPE** drop-down list.
- To resolve all of the undefined symbols with their inferred classes and scopes, click the **Resolve undefined symbols** button .

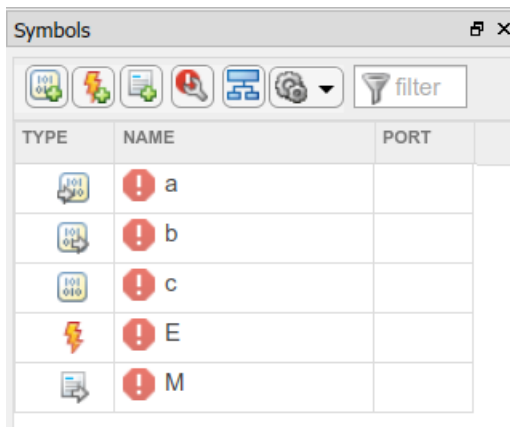

Resolve Symbols Through the Symbol Wizard

If Stateflow detects any undefined symbols when you parse a chart, update a diagram, or simulate a model, the Symbol Wizard opens and lists the undefined symbols. For each undefined symbol, the **Class** and **Scope** columns display the class and scope inferred from the usage in the chart. You can accept, modify, or reject each symbol definition that the Symbol Wizard suggests.

- To accept a definition with the inferred class and scope, select the check box in front of the symbol.

- To modify a definition, select a different class or scope from the **Class** or **Scope** drop-down lists.
- To reject a definition, clear the check box in front of the symbol.

After you edit the symbol definitions, add the symbols to the Stateflow hierarchy by clicking **OK**.

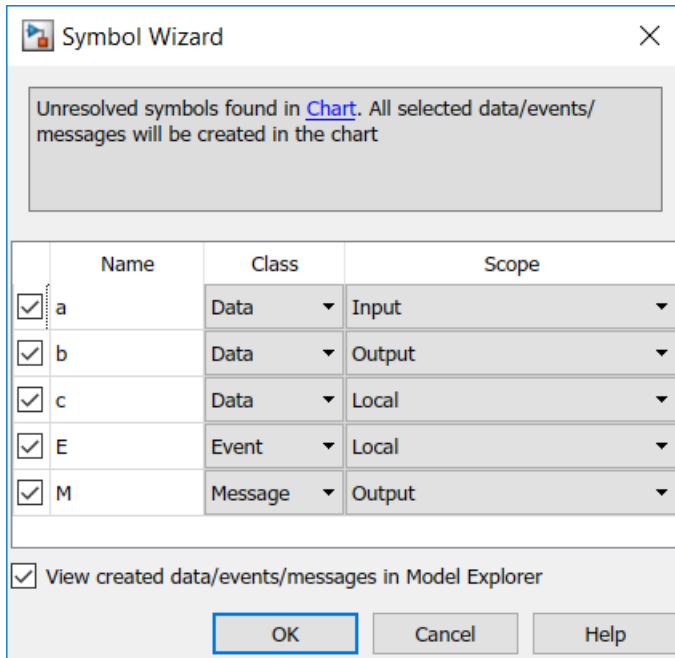

Detect Symbol Definitions in Custom Code

Detection of symbols defined in custom code depends on the model configuration parameter **Import custom code**.

- If you select **Import custom code**, the parser tries to find unresolved chart symbols in the custom code. If the custom code does not define these symbols, they appear in the Symbol Wizard.
- If you do not select **Import custom code**, the parser considers unresolved data symbols in the chart as defined in the custom code. If the custom code does not define these symbols, simulating and generating code from the model results in an error.

The **Import custom code** option is not available for charts that use MATLAB as the action language. For more information, see “Import custom code” (Simulink).



See Also

More About

- “Add Stateflow Data” on page 9-2
- “Set Data Properties” on page 9-5
- “Manage Data, Events, and Messages in the Symbols Pane” on page 34-2
- “Detect Unused Data in the Symbols Pane” on page 34-3
- “Import custom code” (Simulink)

Call Extrinsic MATLAB Functions in Stateflow Charts

Stateflow charts in Simulink models have an action language property that defines the syntax for state and transition actions. An icon in the lower-left corner of the chart canvas indicates the action language for the chart.

-  MATLAB as the action language.
-  C as the action language.

In charts that use C as the action language, you can call built-in MATLAB functions and access MATLAB workspace variables by using the `m1` namespace operator or the `m1` function. For more information, see “Access MATLAB Functions and Workspace Data in C Charts” on page 13-28.

In charts that use MATLAB as the action language, you can call MATLAB functions supported for code generation directly. To call extrinsic functions that are not supported for code generation, you must use the `coder.extrinsic` function. When you declare a function with `coder.extrinsic(function_name)`, Stateflow creates a call to the function during simulation. In a Stateflow chart, you only declare `coder.extrinsic` once. You cannot declare reserved keywords with `coder.extrinsic`. For more information, see “Rules for Naming Stateflow Objects” on page 2-5.

For charts that include atomic subcharts, you must declare functions that are not supported for code generation with `coder.extrinsic` separately within the atomic subchart.

`coder.extrinsic` Function

To create a call for the extrinsic function `heaviside`, this model uses `coder.extrinsic`.

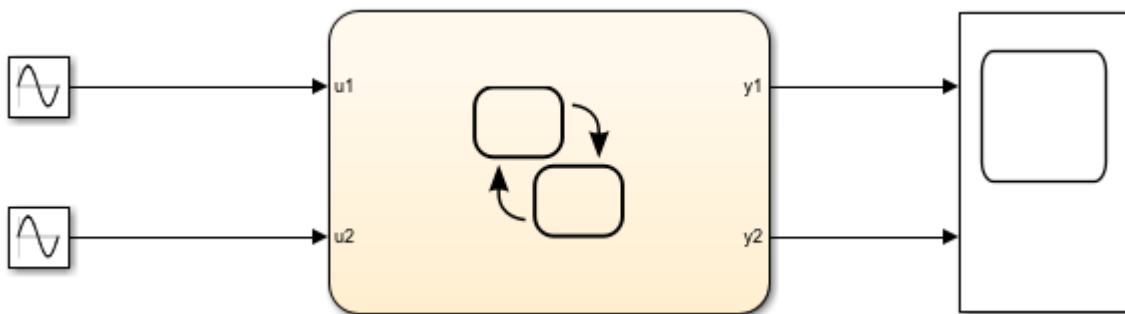

The chart contains two parallel states, A and B, and one graphical function block, `foo`. State A declares the function `heaviside`, which is not supported for code generation, by using `coder.extrinsic`. State B and the graphical function block also use `heaviside` without `coder.extrinsic`.

The input for state A is `u1`, a sine wave, and the input for state B is `u2`, a cosine wave. The graphical function out outputs the value of the `heaviside` function for the input `in`.

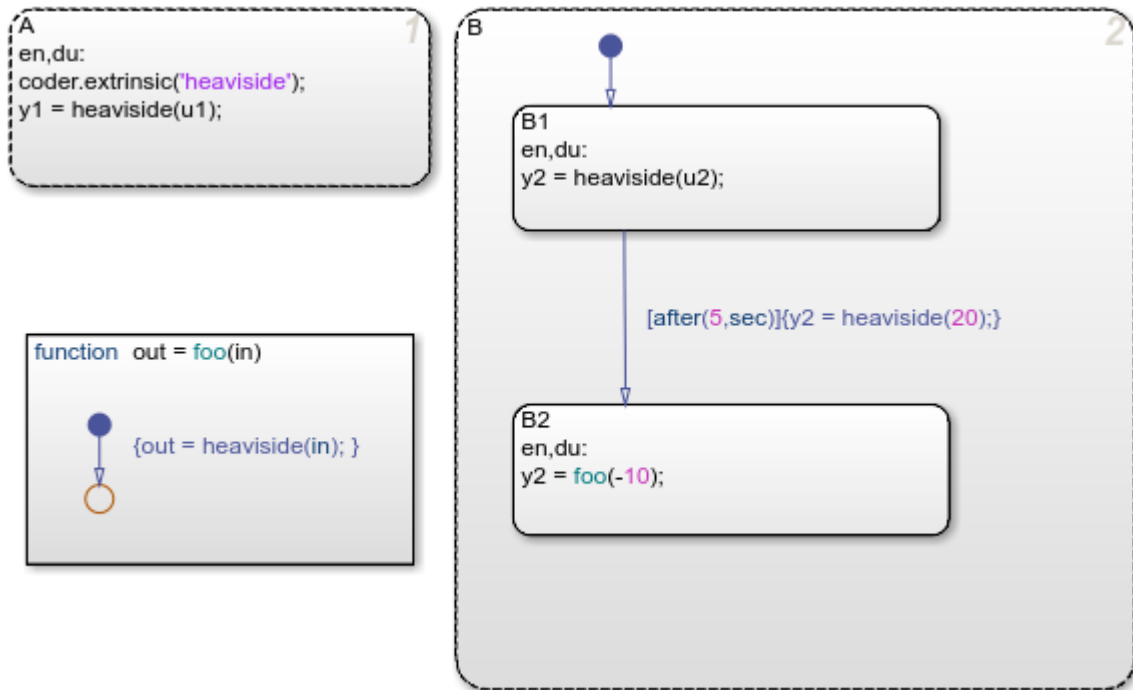

You only need to declare `heaviside` once in your chart using `coder.extrinsic`. After this you can use the `heaviside` function anywhere within your chart without `coder.extrinsic`. When generating code the functions that you declare using `coder.extrinsic` will have a call to the extrinsic function, and that function will not appear in the generated code.

To visualize the result of this chart, open the scope.

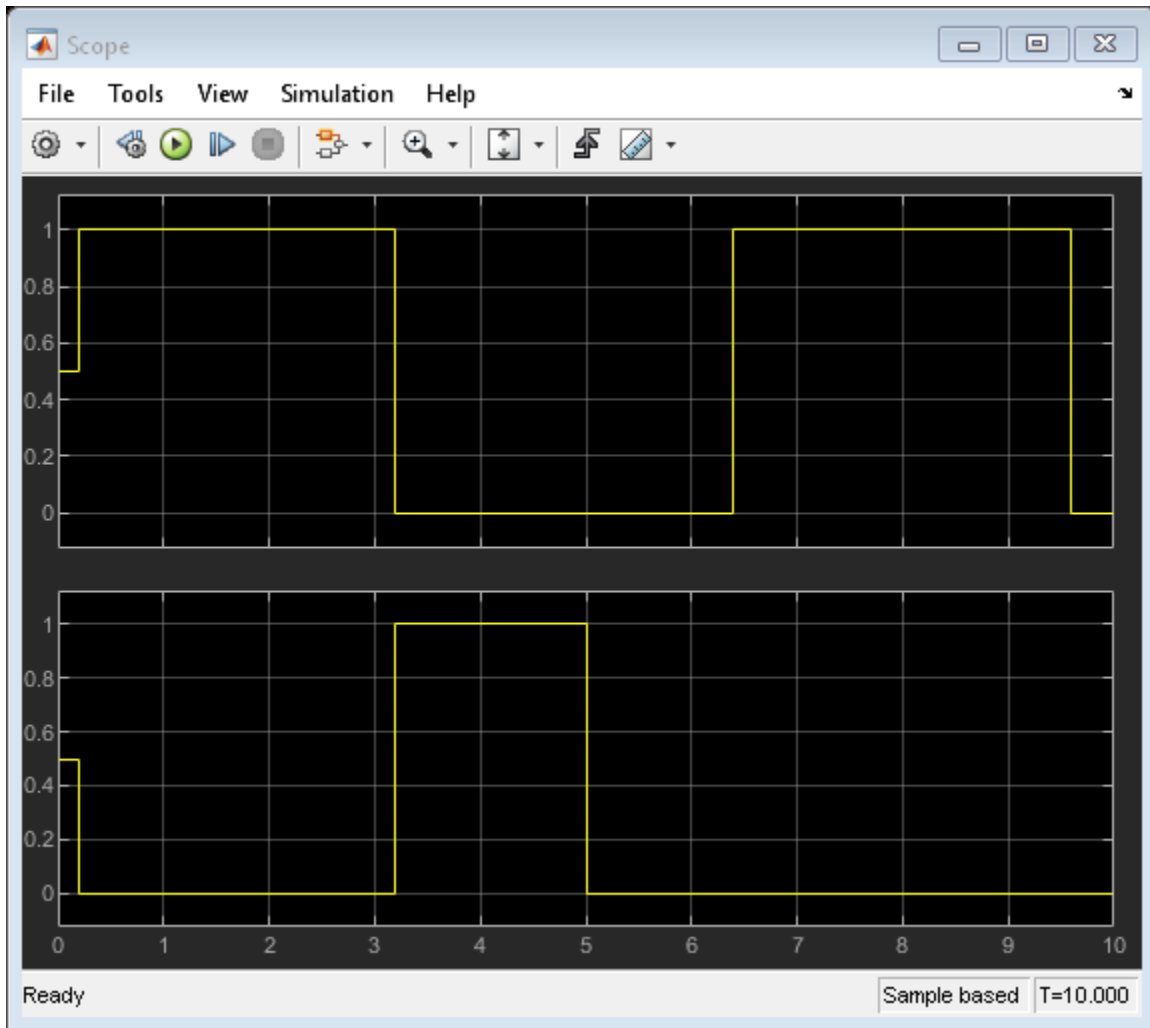

See Also

`coder.extrinsic` | `heaviside`

More About

- "Access MATLAB Functions and Workspace Data in C Charts" on page 13-28
- "Generate Code for Global Data" (MATLAB Coder)
- "Functions and Objects Supported for C/C++ Code Generation" (Simulink)

Code Generation

- “Generate C or C++ Code from Stateflow Blocks” on page 32-2
- “Select Array Layout for Matrices in Generated Code” on page 32-5
- “Software Configurations Using Variant Transitions” on page 32-8
- “Variant Lamp Design” on page 32-13
- “Generate Code from Atomic Subcharts” on page 32-14

Generate C or C++ Code from Stateflow Blocks

To generate C or C++ code from Simulink models that include a Stateflow chart, you must use Simulink Coder. In addition to Simulink Coder, you may use Embedded Coder to further enhance the generated code. Embedded Coder enhancements make your code more readable, more compact, and faster to execute.

When you generate code for a target, Stateflow automatically parses the Stateflow machine, which evaluates the graphical and nongraphical objects and data in each Stateflow machine against the supported chart notation and the action language syntax. For more information, see “Detect Common Modeling Errors During Chart Simulation” on page 33-35.

Generate Code by Using Simulink Coder

Simulink Coder allows you to generate C and C++ code from models that contain Stateflow charts. You can then use the generated code for real-time and nonreal-time applications, including:

- Simulation acceleration
- Rapid prototyping
- Hardware-in-the-loop (HIL) testing

Using Simulink Coder also allows you access to Classic Accelerator and Rapid Accelerator modes. Accelerator modes work by generating target code, which is then used for execution. For more information about these modes, see “How Acceleration Modes Work” (Simulink).

HIL testing allows you to test your controller design and determine if your physical system (plant) model is valid. For more information about HIL testing, see “What Is Hardware-In-The-Loop Simulation?” (Simscape).

To get started setting up a model for code generation with Simulink Coder, see “Configure Model and Generate Code” (Simulink Coder).

Generate Code by Using Embedded Coder

With the addition of Embedded Coder you can generate C or C++ code that is more compact, easier to read, and faster to run. Embedded Coder additionally extends the abilities of Simulink Coder by allowing you control over generated functions, files, and data. Further, Embedded Coder enables easy integration for legacy code, data types, and calibration parameters. Embedded Coder supports software standards for:

- AUTOSAR
- MISRA C
- ASAP2

Embedded Coder also provides support packages with advanced optimizations and device drivers for specific hardware.

To get started setting up a model for code generation with Embedded Coder, see “Generate Code by Using the Quick Start Tool” (Embedded Coder).

Design Tips for Optimizing Generated Code for Stateflow Objects

Do Not Access Machine-Parented Data

This restriction prevents long parameter lists from appearing in the code generated for a graphical function. You can access local data that resides in the same chart as the graphical function. For more information, see “Reuse Logic Patterns by Defining Graphical Functions” on page 8-13.

Be Explicit About the Inline Option of a Graphical Function

When you use a graphical function in a Stateflow chart, select `InLine` or `Function` for the property **Function Inline Option**. Otherwise, the code generated for a graphical function may not appear as you want. For more information, see “Specify Graphical Function Properties” on page 8-15.

Avoid Using Multiple Edge-Triggered Events in Stateflow Charts

If you use more than one trigger, you generate multiple code statements to handle rising or falling edge detections. If multiple triggers are required, use function-call events instead. For more information, see “Activate a Stateflow Chart by Sending Input Events” on page 11-7.

Combine Input Signals of a Chart Into a Single Bus Object

When you use a bus object, you reduce the number of parameters in the parameter list of a generated function. This guideline also applies to output signals of a chart. For more information, see “Define Stateflow Structures” on page 26-2.

Use Discrete Sample Times

The code generated for discrete charts that are not inside a triggered or enabled subsystem uses integer counters to track time instead of Simulink provided time. The generated code uses less memory, and enables code for use in Software-in-the-Loop (SIL) and Processor-in-the-Loop (PIL) simulation modes.

Generate Code for Rapid Prototyping and Production Deployment

This table directs you to information about code generation based on your goals.

Goal	Simulink Coder Documentation	Embedded Coder Documentation
Generate C/C++ source code	“Source Code Generation in Simulink Coder” (Simulink Coder)	“Code Generation Basics” (Embedded Coder)
Generate C/C++ source code and build executable	“Program Building, Interaction, and Debugging in Simulink Coder” (Simulink Coder)	
Integrate external code	“External Code Integration” (Simulink Coder)	“Code Integration” (Embedded Coder)

Goal	Simulink Coder Documentation	Embedded Coder Documentation
Include external code only for library charts in a portable, self-contained library for use in multiple models	"Integrate External Code for Library Charts" (Simulink Coder)	"Integrate External Code for Library Charts" (Embedded Coder)
Optimize generated code	"Reduce Memory Usage for Boolean and State Configuration Variables" (Simulink Coder)	"Reduce Memory Usage for Boolean and State Configuration Variables" (Embedded Coder)

Traceability of Stateflow Objects in Generated Code

Traceability comments provide a way to:

- Verify generated code. You can identify which Stateflow object corresponds to a line of code and track code from different objects that you have or have not reviewed.
- Include comments in code generated for large-scale models. You can identify objects in generated code and avoid manually entering comments or descriptions.

To enable traceability comments, you must have Embedded Coder or HDL Coder software. For C/C++ code generation, comments appear in the generated code for embedded real-time (ert) based targets only. For more information, see "Trace Stateflow Elements in Generated Code" (Embedded Coder) and "Navigate Between Simulink Model and HDL Code by Using Traceability" (HDL Coder).

See Also

More About

- "Generate Code from Atomic Subcharts" on page 32-14
- "Select Array Layout for Matrices in Generated Code" on page 32-5

Select Array Layout for Matrices in Generated Code

When generating code from a Stateflow chart that uses C as the action language, you can specify the array layout for matrices. For example, consider this matrix:

$$\begin{bmatrix} 1 & 2 & 3 \\ 4 & 5 & 6 \end{bmatrix}$$

By default, the code generator uses column-major layout to flatten the matrix as a one-dimensional array. The array is stored in memory with this arrangement:

```
{1, 4, 2, 5, 3, 6}
```

If you select row-major layout, the code generator flattens the matrix and stores it in memory with this arrangement:

```
{1, 2, 3, 4, 5, 6}
```

If you have Embedded Coder, you can preserve the multidimensionality of Stateflow local data, prevent its flattening, and implement the matrix as a two-dimensional array with this arrangement:

```
{{1, 2, 3}, {4, 5, 6}}
```

Row-major and multidimensional array layout can ease the integration with external code. For more information, see “Code Generation of Matrices and Arrays” (Simulink Coder) and “Dimension Preservation of Multidimensional Arrays” (Embedded Coder).

Column-Major Array Layout

By default, the **Array Layout** configuration parameter for a Simulink® model is **Column-Major**. When you press **Ctrl-B**, the code generator flattens all matrix data into one-dimensional arrays, arranging their contents in a column-major layout.

For example, this Stateflow chart contains local data x of size [2 3]. The state actions index the elements in x by row and column number.

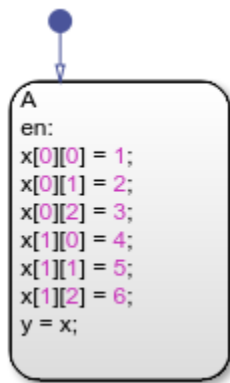

If you generate code, the file `sf_matrix_layout.c` implements the local data x in column-major layout with these lines of code:

```

...
sf_matrix_layout_DW.x[0] = 1.0;
sf_matrix_layout_DW.x[2] = 2.0;
sf_matrix_layout_DW.x[4] = 3.0;
sf_matrix_layout_DW.x[1] = 4.0;
sf_matrix_layout_DW.x[3] = 5.0;
sf_matrix_layout_DW.x[5] = 6.0;
...

```

The generated code refers to the elements of `x` by using only one index.

Row-Major Array Layout

Row-major layout can improve the performance of certain algorithms. For example, see “Interpolation Algorithm for Row-Major Array Layout” (Embedded Coder).

To generate code that uses row-major array layout:

- 1 Open the Model Configuration Parameters dialog box.
- 2 In the **Code Generation** > **Interface** pane, set the **Array Layout** parameter to Row-Major.
- 3 Press **Ctrl+B**.

When you select row-major layout for the previous example, the file `sf_matrix_layout.c` implements the local data `x` with these lines of code:

```

...
sf_matrix_layout_DW.x[0] = 1.0;
sf_matrix_layout_DW.x[1] = 2.0;
sf_matrix_layout_DW.x[2] = 3.0;
sf_matrix_layout_DW.x[3] = 4.0;
sf_matrix_layout_DW.x[4] = 5.0;
sf_matrix_layout_DW.x[5] = 6.0;
...

```

The generated code refers to the elements of `x` by using only one index.

Note If you enable row-major array layout in a chart that uses custom C code, all global variables and arguments of functions defined in the custom code must be scalars, vectors, or structures of scalars and vectors. Specify the size of an n -element vector as n , and not as $[n\ 1]$ or $[1\ n]$.

Multidimensional Array Layout

If you have Embedded Coder, you can generate code that preserves the multidimensionality of Stateflow data without flattening the data as one-dimensional arrays.

For the previous example, the file `sf_matrix_layout.c` implements the local data `x` with these lines of code:

```

...
sf_matrix_layout_DW.x[0][0] = 1.0;
sf_matrix_layout_DW.x[0][1] = 2.0;
sf_matrix_layout_DW.x[0][2] = 3.0;
sf_matrix_layout_DW.x[1][0] = 4.0;

```

```
sf_matrix_layout_DW.x[1][1] = 5.0;  
sf_matrix_layout_DW.x[1][2] = 6.0;  
...
```

The generated code refers to the elements of `x` by using two indices.

Multidimensional array layout is available for:

- Constant and local data in Stateflow charts.
- Charts that contain messages.
- Parameters and root-level inport and outport data in Simulink models.

Multidimensional layout is not available for bus signals containing multidimensional array data. Multidimensional layout is not supported in:

- Reusable charts or charts in reusable parent subsystems.

For more information, see “Preserve Dimensions of Multidimensional Arrays in Generated Code” (Embedded Coder).

See Also

More About

- “Generate C or C++ Code from Stateflow Blocks” on page 32-2
- “Code Generation of Matrices and Arrays” (Simulink Coder)
- “Interpolation Algorithm for Row-Major Array Layout” (Embedded Coder)
- “Dimension Preservation of Multidimensional Arrays” (Embedded Coder)

Software Configurations Using Variant Transitions

With variant transitions, you can create Stateflow charts in Simulink models that generate code that can be used in a variety of different software situations. Variant transitions allow you to model a full subset of variations within one Stateflow chart so that you can choose which variation you want when you generate code or when you compile the generated code.

Variant transitions are guarded by Simulink parameters or MATLAB variables in a condition and connect states within your chart that are variations from the core chart configuration. Variant transition conditions are evaluated during code compile or code generation instead of at runtime. In addition to this, the generated code only contains the data members needed to execute the currently selected software configuration.

Chart variations are supported only in code generation. Stateflow charts that you develop with variant transitions simulate according to which portion of your chart is active.

Variant transitions can not be used in conjunction with actions on default transition paths of a state or a chart.

Create a Variant Configuration

Variant transitions connect variant configurations to your core Stateflow chart. Variant configurations are only active when the variant transition condition is true.

In this example, you will add variant configurations to a basic control system that turns a lamp on and off. The variant configurations allow the lamp to dim in multiple ways. Once you add in the variant configurations to your Stateflow chart, you can choose to generate code for any configuration.

Initially, your Stateflow chart includes two states, `Off` and `On`. The light turns on when the event, `SWITCH_ON`, is sent to the chart. The light turns off when the event, `SWITCH_OFF`, is sent to the chart.

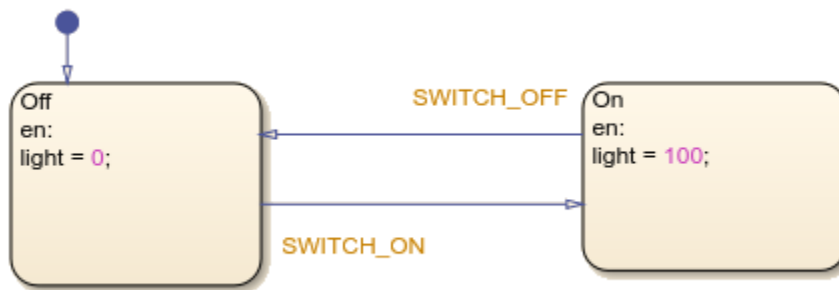

Some of the lamps have the ability to be dimmed. Within that subset, there are lamps that can be set high or low and lamps that can only be set to high, medium, or low. To add these capabilities to the Stateflow chart, you add in three variations: `Dimmer1`, `Dimmer2`, and `NoDimmer`. `Dimmer1` has three substates, `High`, `Medium`, and `Low`. `Dimmer2` has two substates, `High` and `Low`.

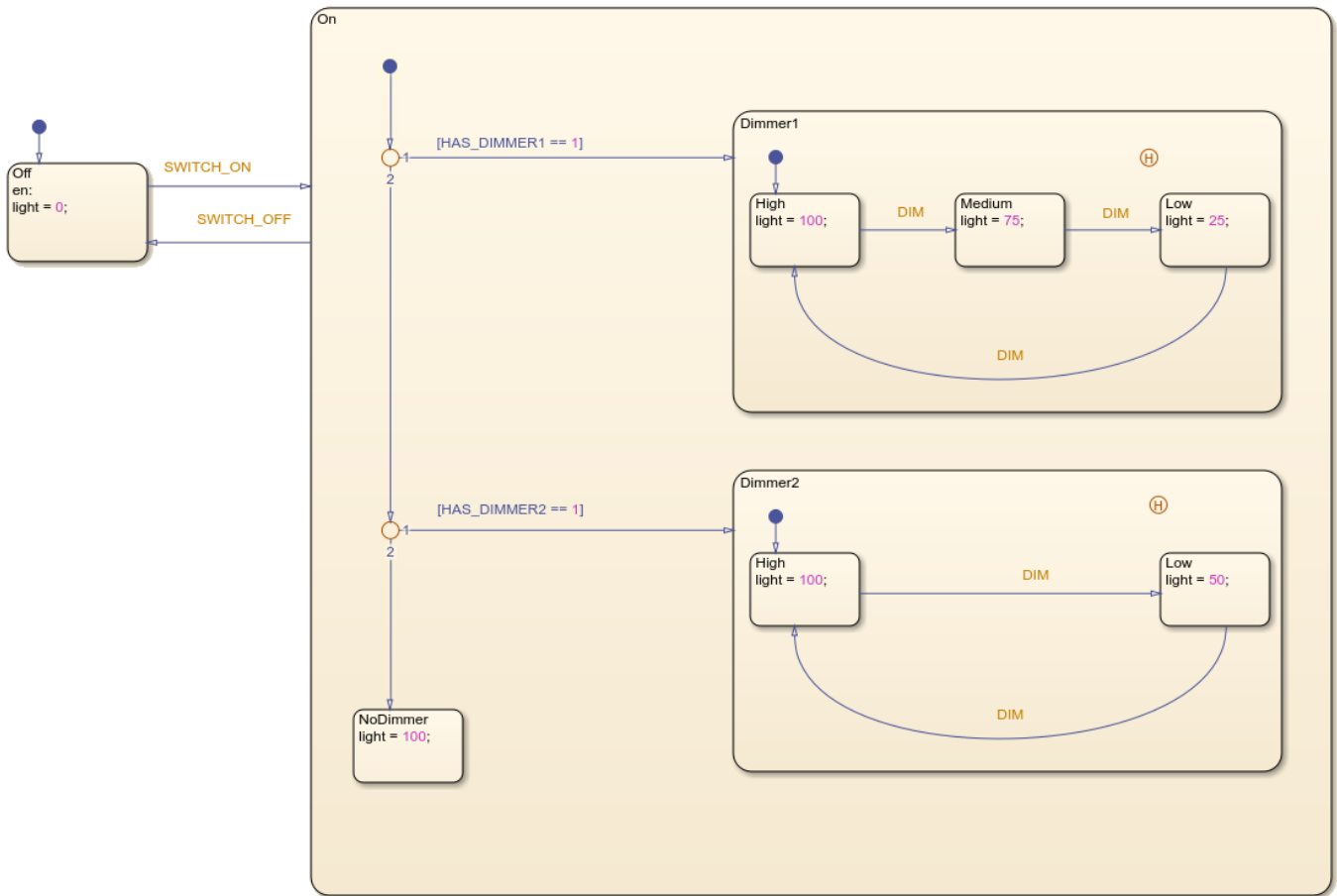

Entry to the variant configurations are guarded by a transition condition that uses a Simulink parameter or MATLAB variable that is defined in the base workspace. To change the transition to a variant transition, click the transition. In the **Transition** tab, select **Variant Transition**. The transition appears on the chart with a # symbol, which indicates that the transition is a variant transition.

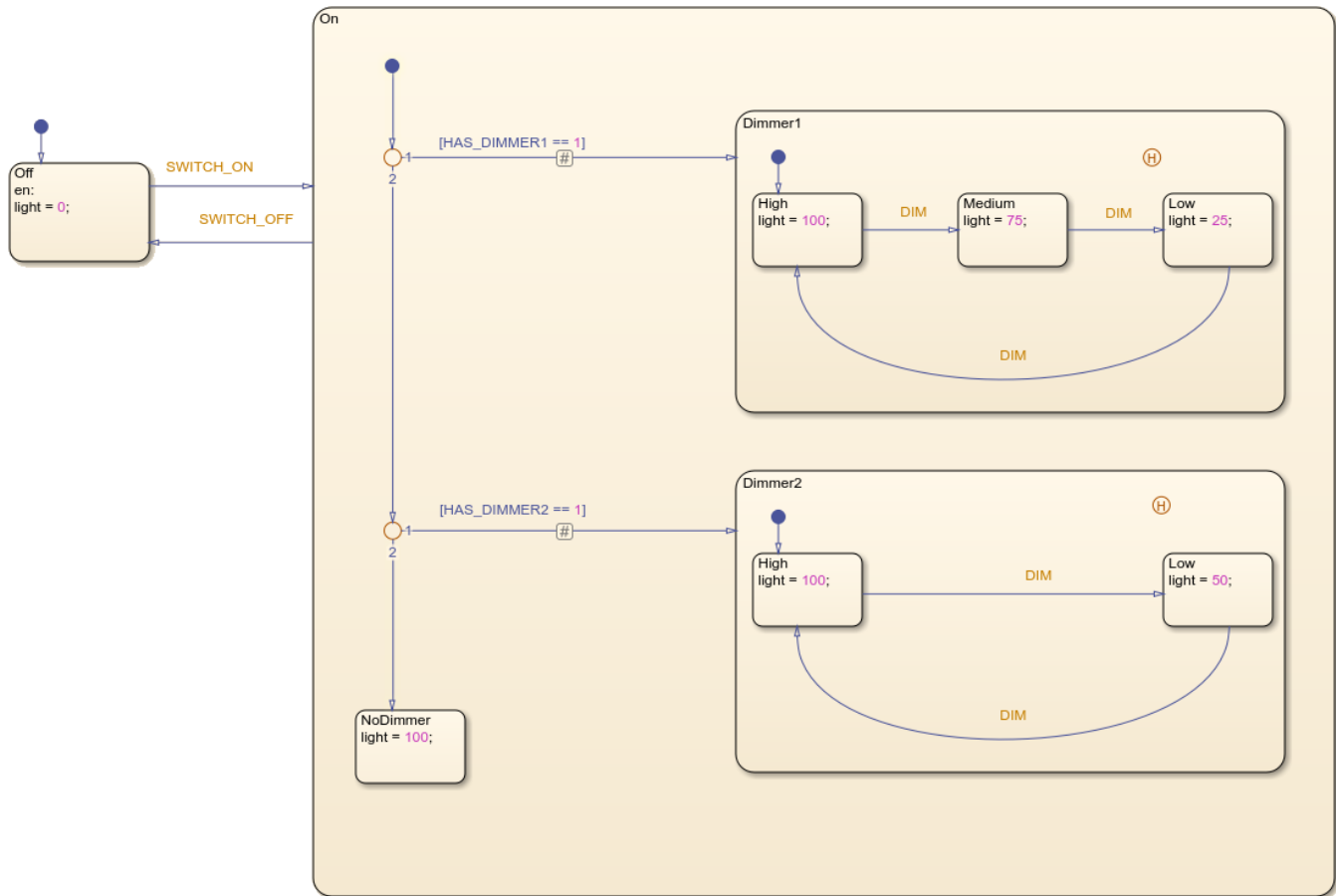

In this example, the variant configurations are guarded by a condition with a Simulink parameter. In this case, `HAS_DIMMER1` is a parameter object. In order for the variant configuration to be active, the condition `[HAS_DIMMER1 == 1]` must be true. For more information about Simulink parameters, see “Set Block Parameter Values” (Simulink).

During simulation, your Stateflow chart executes only the active portion of your Stateflow chart. The inactive portion appears grayed out on the Stateflow canvas. To change which portion of the chart is currently active, update the guarding parameter in the base workspace.

Generate Code for Variant Configurations

You must have Simulink Coder or Embedded Coder to generate code from your Stateflow chart. By default, the generated code only contains the active variant state machine.

If you are using Embedded Coder, you can choose to include a preprocessor conditional statement in your generated code. In the Stateflow editor, on the **Modeling** tab, under **Design Data**, select **Property Inspector**. Under **Advanced**, select **Generate preprocessor conditionals**.

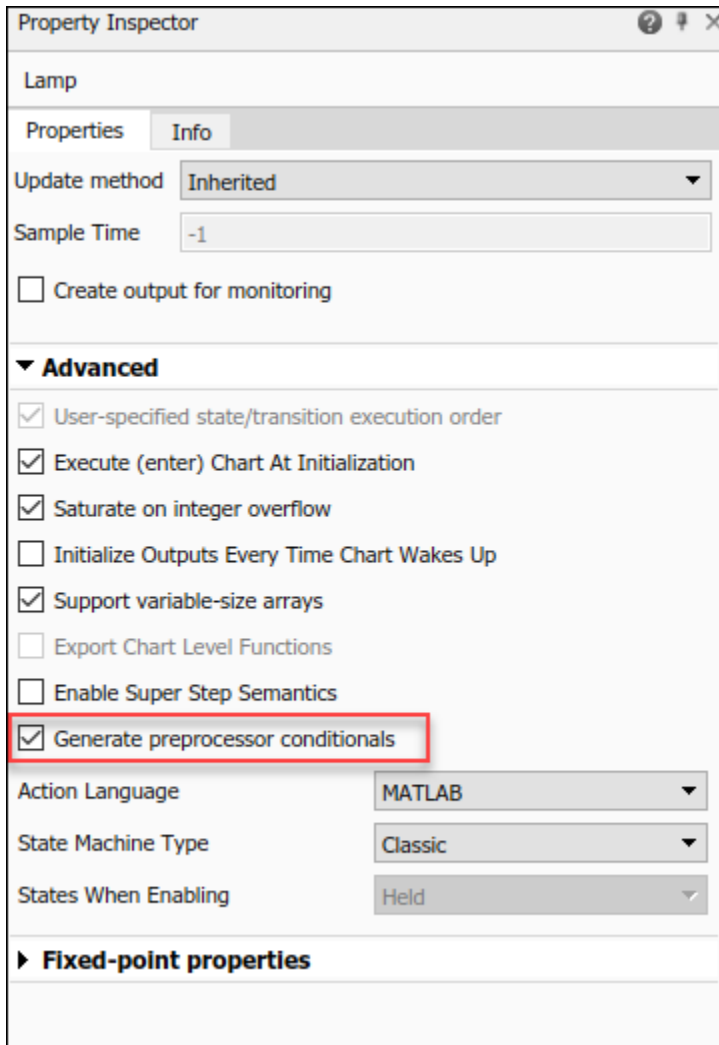

For more information about generating code, see “Generate Code Using Simulink® Coder™” (Simulink Coder) and “Generate Code Using Embedded Coder®” (Embedded Coder).

Using the Variant Manager

The Variant Manager is a central tool that allows you to manage variant configurations in your system model. In the Stateflow editor, on the **Modeling** tab, under **Design Data**, select **Variant Manager**.

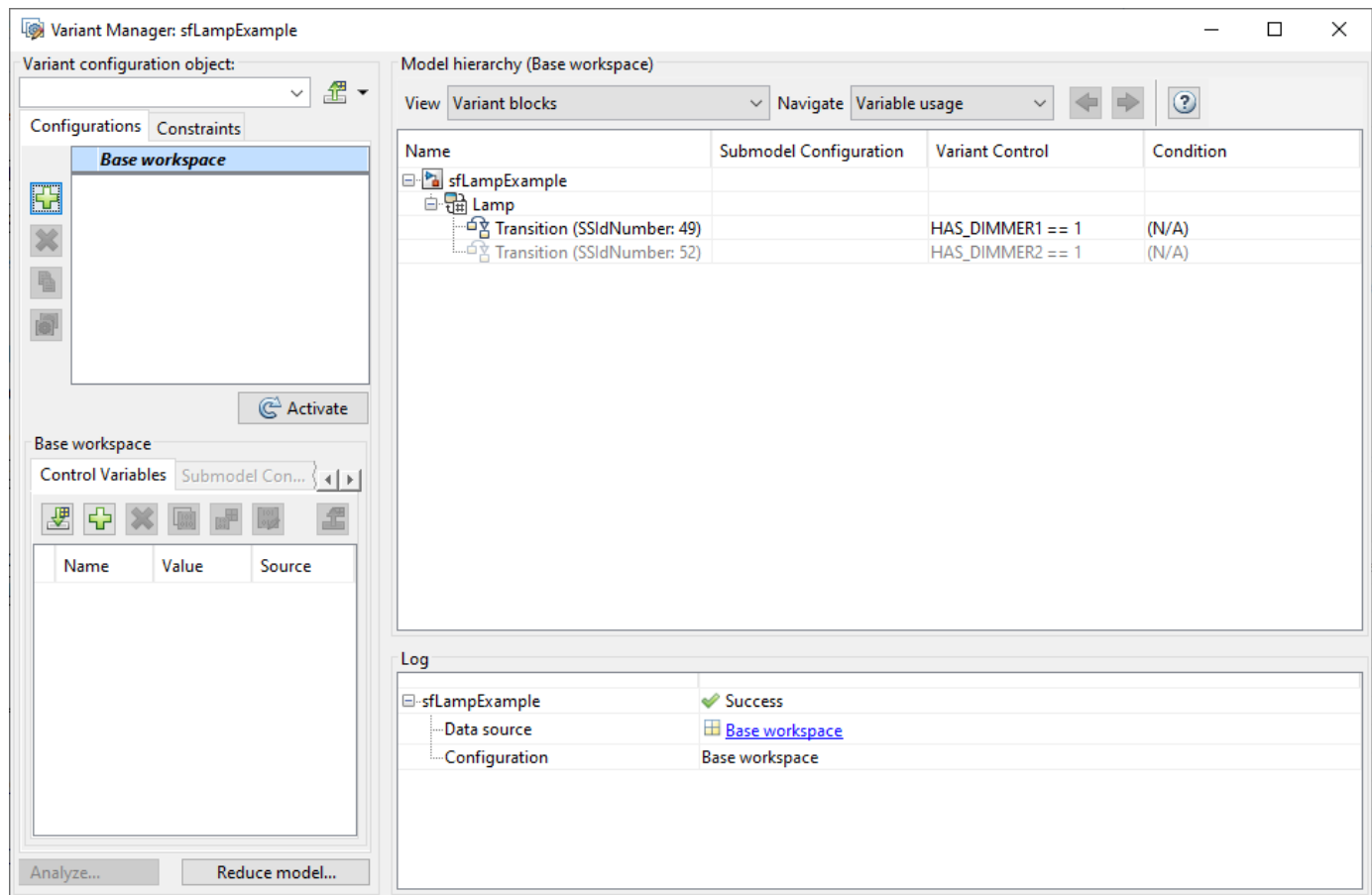

For more information about the Variant Manager, see “Variant Manager Overview” (Simulink).

See Also

More About

- “Generate C or C++ Code from Stateflow Blocks” on page 32-2
- “Choose Storage Class for Controlling Data Representation in Generated Code” (Simulink Coder)

Variant Lamp Design

This example shows how to design a system that uses variant transitions to generate code that can be used in a variety of different software situations.

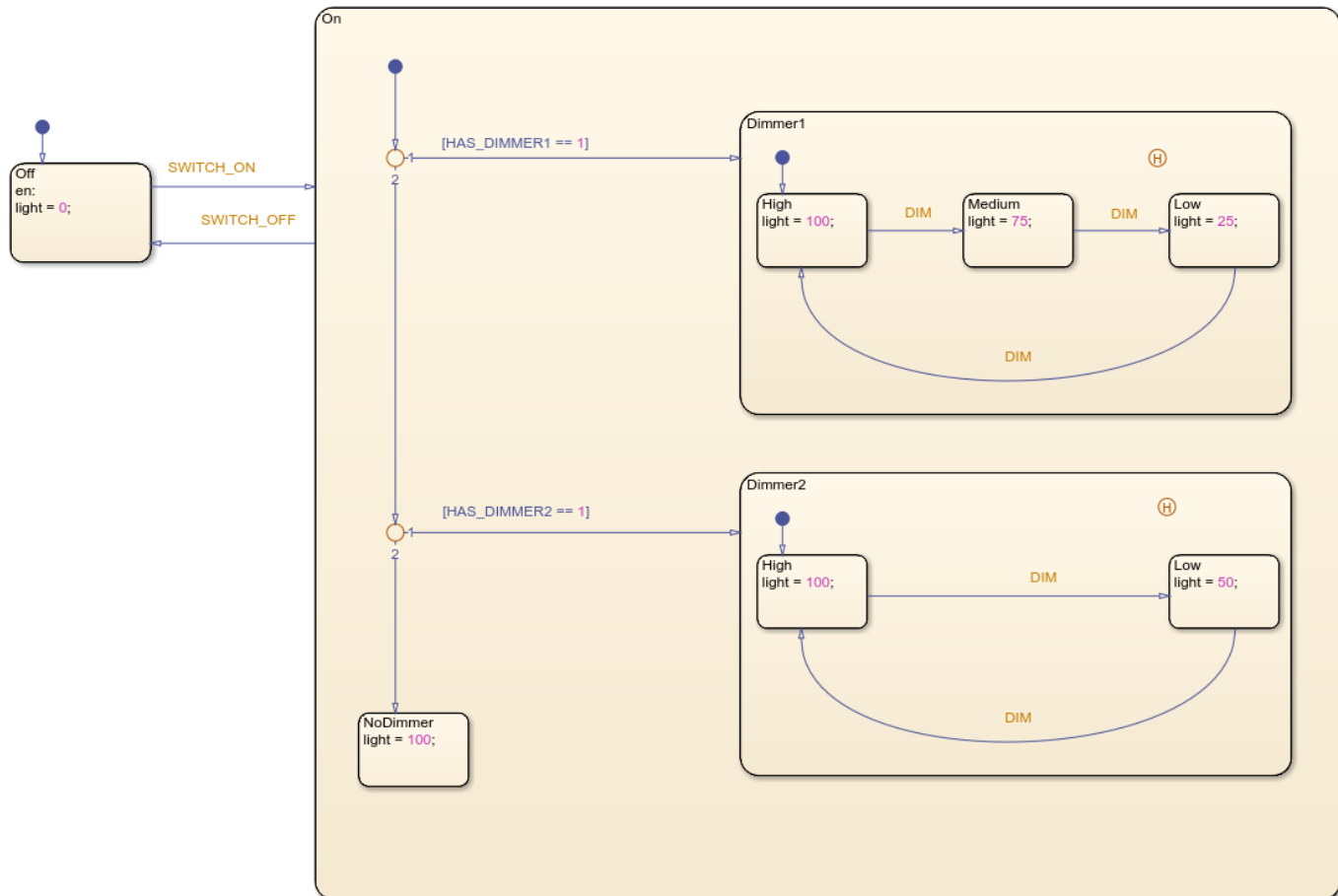

Some of the lamps have the ability to be dimmed. Within that subset, there are lamps that can be set high or low and lamps that can only be set to high, medium, or low.

Entry to the variant configurations are guarded by a transition condition that uses a Simulink parameter or MATLAB variable that is defined in the base workspace.

In this example, the variant configurations are guarded by a condition with a Simulink parameter. In this case, `HAS_DIMMER1` and `HAS_DIMMER2` are parameter objects.

When you generate code from the Simulink model, your code includes only the active variant state machine. If using Embedded Coder, you have the option to include a preprocessor conditional statement in the generated code.

Generate Code from Atomic Subcharts

To unit test a Stateflow chart in a Simulink model, first break the chart into smaller, independent components by using atomic subcharts. When you generate code for your chart, a separate file stores the code for the atomic subchart. Generating reusable code from atomic subcharts is useful for testing individual parts of your Stateflow chart. For more information, see “Create Reusable Subcomponents by Using Atomic Subcharts” on page 16-2.

Generate Reusable Code for Unlinked Atomic Subcharts

To specify code generation parameters for an unlinked atomic subchart:

- 1 In your chart, right-click the atomic subchart and select **Properties**.
- 2 In the dialog box, specify these parameters:
 - a Set **Code generation function packaging** to `Reusable function`.
 - b Set **Code generation file name options** to `User specified`.
 - c For **Code generation file name**, enter the name of the file with no extension.
- 3 Open the Configuration Parameters dialog box by pressing **Ctrl+E**.
- 4 In the **Code Generation** tab, set the **System target file** parameter to `ert.tlc`.
- 5 (OPTIONAL) Customize the generated function names for atomic subcharts. In the Configuration Parameters dialog box, in the **Code Generation > Identifiers** tab, set the **Subsystem methods** parameter. Specify the format of the function names by using a combination of these tokens:
 - `$R` — root model name
 - `$F` — type of interface function for the atomic subchart
 - `$N` — block name
 - `$H` — subsystem index
 - `$M` — name-mangling text

For more information, see “Generate Separate Code for an Atomic Subchart” on page 16-35.

Generate Reusable Code for Linked Atomic Subcharts

To specify code generation parameters for linked atomic subcharts from the same library:

- 1 Open the library model that contains your atomic subchart.
- 2 Unlock the library.
- 3 Right-click the library chart and select **Block Parameters**.
- 4 In the dialog box, specify these parameters:
 - a On the **Main** tab, select **Treat as atomic unit**.
 - b On the **Code Generation** tab, set **Function packaging** to `Reusable function`.
 - c Set **File name options** to `User specified`.
 - d For **File name**, enter the name of the file with no extension.
- 5 In the **Code Generation** tab, set the **System target file** parameter to `ert.tlc`.

- 6** (OPTIONAL) Customize the generated function names for atomic subcharts. In the Configuration Parameters dialog box, in the **Code Generation > Identifiers** tab, set the **Subsystem methods** parameter. Specify the format of the function names by using a combination of these tokens:
- \$R — root model name
 - \$F — type of interface function for the atomic subchart
 - \$N — block name
 - \$H — subsystem index
 - \$M — name-mangling text

When you generate code for your model, a separate file stores the code for linked atomic subcharts from the same library.

See Also

More About

- “Create Reusable Subcomponents by Using Atomic Subcharts” on page 16-2
- “Generate C or C++ Code from Stateflow Blocks” on page 32-2
- “Generate Separate Code for an Atomic Subchart” on page 16-35

Debug and Test Stateflow Charts

- “Debugging Stateflow Charts” on page 33-2
- “Set Breakpoints to Debug Charts” on page 33-3
- “Inspect and Modify Data and Messages While Debugging” on page 33-9
- “Control Chart Execution After a Breakpoint” on page 33-16
- “Debug Run-Time Errors in a Chart” on page 33-20
- “Animate Stateflow Charts” on page 33-23
- “Detect Modeling Errors During Edit Time” on page 33-24
- “Detect Common Modeling Errors During Chart Simulation” on page 33-35
- “Avoid Unwanted Recursion in a Chart” on page 33-39
- “Monitor Test Points in Stateflow Charts” on page 33-41
- “Log Simulation Output for States and Data” on page 33-45
- “Log Data in Library Charts” on page 33-52
- “Commenting Stateflow Objects in a Chart” on page 33-56

Debugging Stateflow Charts

For Stateflow charts in Simulink models, you can perform most debugging tasks directly from the Stateflow Editor:

- Set breakpoints to stop execution in specific objects, such as charts, states, transitions, graphical functions, truth table functions, local events, and input events.
- Enable, disable, and set conditions on breakpoints in the Breakpoints and Watch window.
- Add data that you want to monitor during simulation in the Breakpoints and Watch window.
- After execution stops at a breakpoint, change data values and step through the simulation.

In addition, during simulation, you can display and change the values of Stateflow data in the MATLAB Command Window.

For information on debugging Stateflow chart objects that you execute in MATLAB, see “Debug a Standalone Stateflow Chart” on page 35-13.

See Also

More About

- “Set Breakpoints to Debug Charts” on page 33-3
- “Inspect and Modify Data and Messages While Debugging” on page 33-9
- “Control Chart Execution After a Breakpoint” on page 33-16
- “Debug Run-Time Errors in a Chart” on page 33-20

Set Breakpoints to Debug Charts

You enable debugging for a Stateflow chart when you set a breakpoint. A breakpoint is a point on a Stateflow chart that pauses the simulation so you can examine the status of the chart. While simulation is paused, you can view Stateflow data, interact with the MATLAB workspace, and step through the simulation. For more information, see “Debugging Stateflow Charts” on page 33-2.

Breakpoints appear as circular red badges. For example, this chart contains breakpoints on the `upshifting` state and the transition from `steady_state` to `upshifting`.

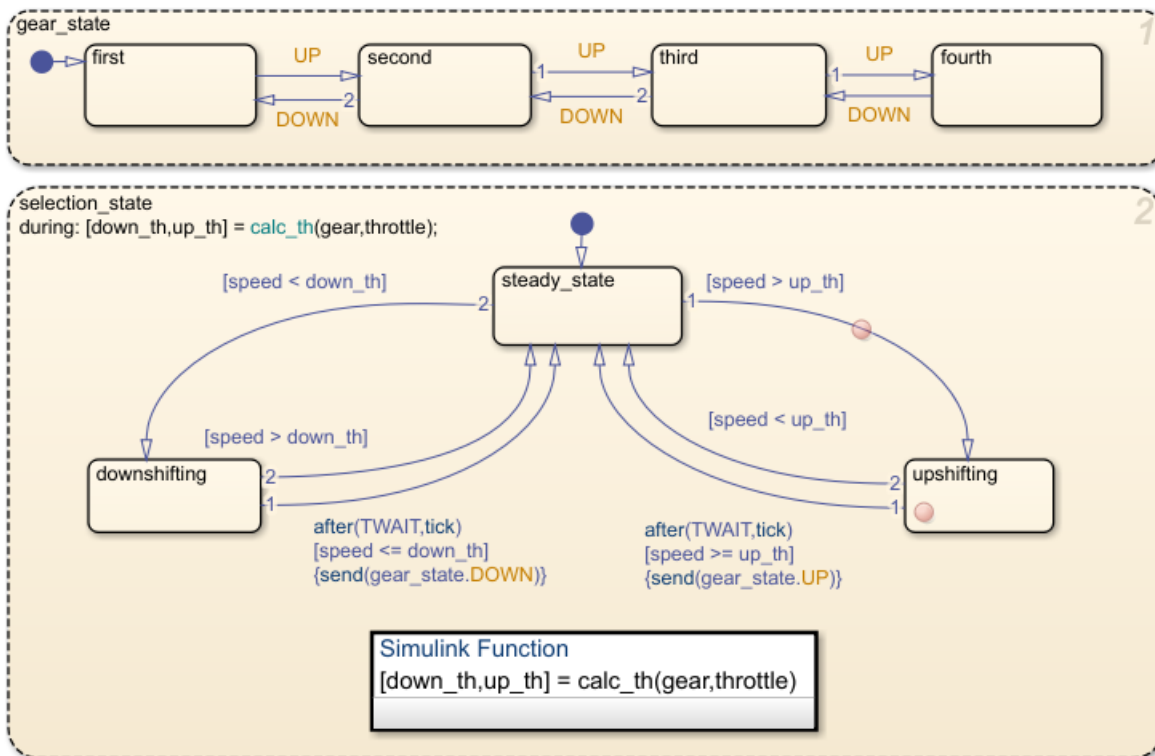

Set a Breakpoint for a Stateflow Object

You can set breakpoints on charts, states, transitions, graphical or truth table functions, and events.

Breakpoints on Charts

To set a breakpoint on a chart, right-click inside the chart and select **Set Breakpoint on Chart Entry**. This type of breakpoint pauses the simulation before entering the chart.

To remove the breakpoint, right-click inside the chart and clear the **Set Breakpoint on Chart Entry** option.

Breakpoints on States and Transitions

You can set different types of breakpoints on states and transitions.

Object	Breakpoint Type
State	On State Entry — Pause the simulation before performing the state entry actions.
	During State — Pause the simulation before performing the state during actions.
	On State Exit — Pause the simulation after performing the state exit actions.
Transition	When Transition is Tested — Pause the simulation before testing that the transition is a valid path. If no condition exists on the transition, this breakpoint type is not available.
	When Transition is Valid — Pause the simulation after the transition is valid, but before taking the transition.

To set a breakpoint on a state or transition, right-click the state or transition and select **Set Breakpoint**. For states, the default breakpoints are **On State Entry** and **During State**. For transitions, the default breakpoint is **When Transition is Valid**. To change the type of breakpoint, click the breakpoint badge and select a different configuration of breakpoints. For more information, see “Change Breakpoint Types” on page 33-5.

To remove the breakpoint, right-click the state or transition and select **Clear Breakpoint**.

Breakpoints on Stateflow Functions

To set a breakpoint on a graphical or truth table function, right-click the function and select **Set Breakpoint During Function Call**. This type of breakpoint pauses the simulation before calling the function.

To remove the breakpoint, right-click the function and clear the **Set Breakpoint During Function Call** option.

Breakpoints on Events

You can select two types of breakpoints on events:

- **Start of Broadcast** — Pause the simulation before broadcasting the event.
- **End of Broadcast** — Pause the simulation after a Stateflow object reads the event.

Available breakpoints depend on the scope of the event.

Scope of Event	Start of Broadcast	End of Broadcast
Local	Available	Available
Input	Available	Not available
Output	Not available	Not available

To set or clear breakpoints on an event, use the Property Inspector or the Model Explorer to modify the **Debugger Breakpoints** properties. For more information, see “Debugger Breakpoints” on page 11-6.

Change Breakpoint Types

A breakpoint badge can represent more than one type of breakpoint. To see a tooltip that lists the breakpoint types that are set on a Stateflow object, point to its badge. In this example, the badge on the state upshifting represents two breakpoint types: On State Entry and During State.

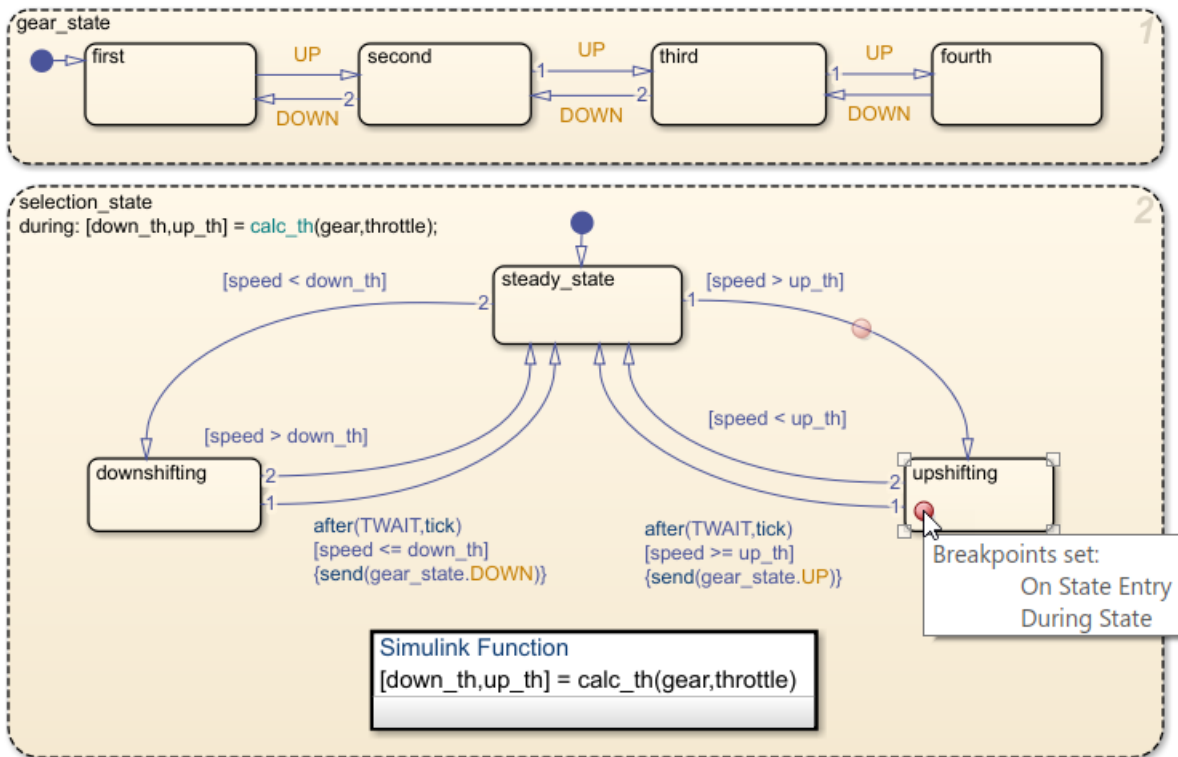

To change the type of breakpoint on an object, click the breakpoint badge. In the Breakpoints dialog box, you can select a different configuration of breakpoints, depending on the object type.

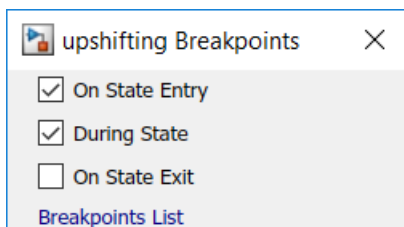

Clearing all of the check boxes in the Breakpoints dialog box removes the breakpoint.

Add Breakpoint Conditions

To limit the number of times that the simulation stops at a breakpoint, add a condition to the breakpoint. By default, a Stateflow chart pauses whenever it reaches a breakpoint. When you add a condition to a breakpoint, the chart pauses at the breakpoint only when the condition is true.

To add a condition to a breakpoint:

- 1 On the **Debug** tab, click **Breakpoints List** to open the Stateflow Breakpoints and Watch window. Alternatively, you can open the Breakpoints and Watch window by clicking the **Breakpoints List** link in the Breakpoints dialog box.
- 2 Select the **Breakpoints** tab. The **Breakpoints** tab lists all of the breakpoints in the chart. For more information, see “Manage Breakpoints Through the Breakpoints and Watch Window” on page 33-7.
- 3 Under the **Condition** column, enter a condition for the breakpoint. You can use any valid MATLAB expression that combines numerical values and Stateflow data objects that are in scope at the breakpoint.

Note You cannot use message data in a breakpoint condition expression.

For example, this chart has a breakpoint on the transition from `steady_state` to `upshifting`. This breakpoint stops the simulation every time that the transition is tested, even if the value of `speed` is far below `up_th`.

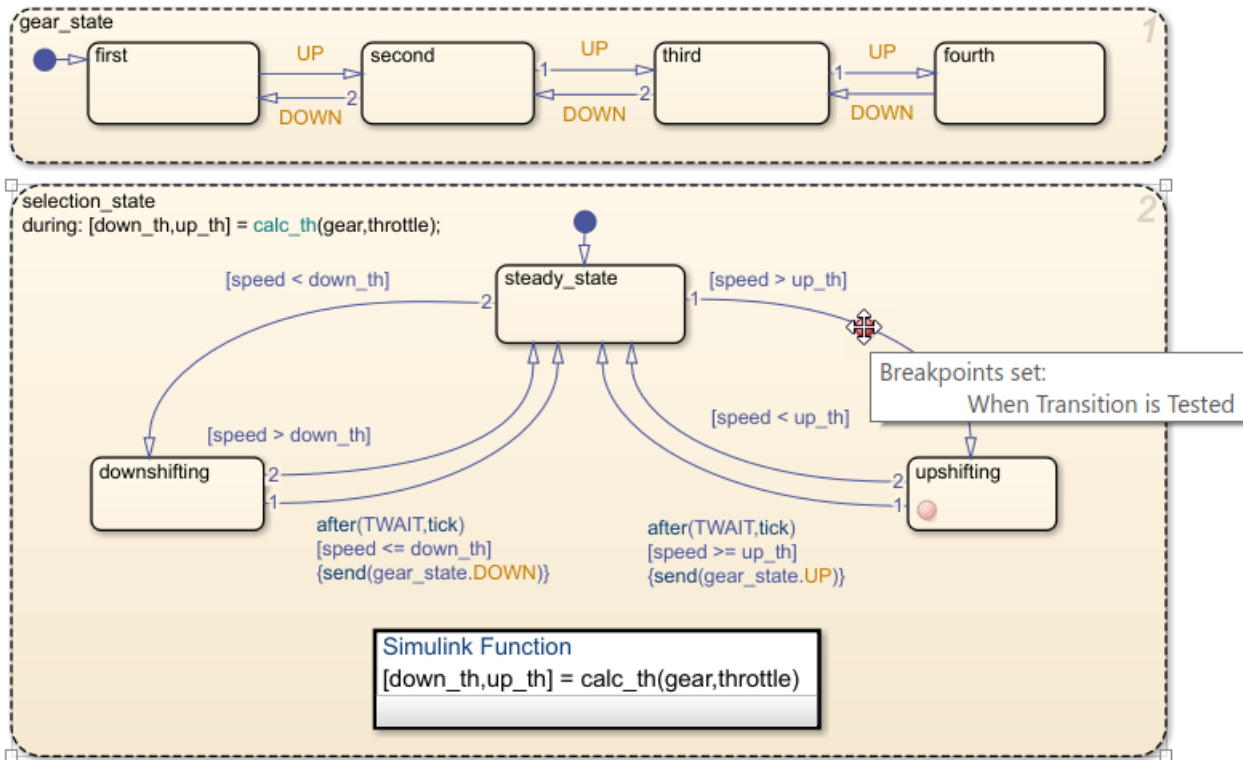

To inspect the chart before the transition is taken, you want the breakpoint to pause the simulation only when the value of `speed` is approaching the value of `up_th`. When you set the condition `speed > up_th - 2` on the breakpoint, the simulation pauses only when the value of `speed` is within 2 of the value of `up_th`.

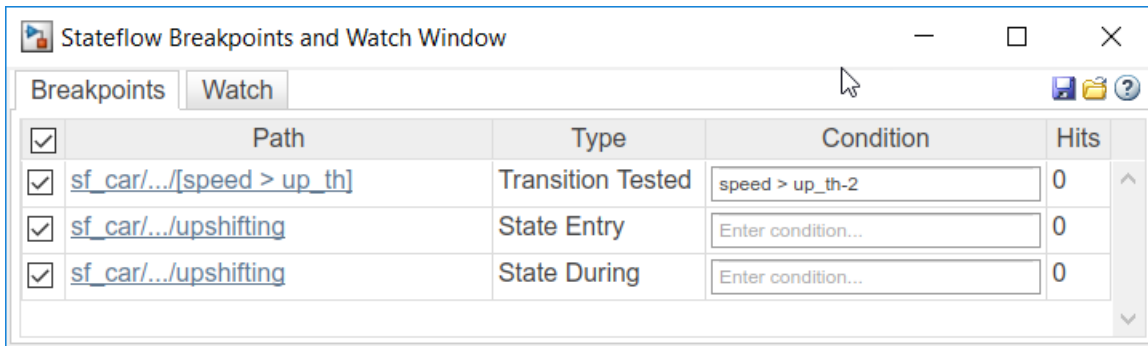

When the simulation pauses, you can inspect the values of the variables `speed` and `up_th` and step through the simulation. For more information, see “Inspect and Modify Data and Messages While Debugging” on page 33-9 and “Control Chart Execution After a Breakpoint” on page 33-16.

Manage Breakpoints Through the Breakpoints and Watch Window

You can manage all of the breakpoints in the chart in the Stateflow Breakpoints and Watch window. To open the Breakpoints and Watch window, on the **Debug** tab, click **Breakpoints List**. Alternatively, open the Breakpoints dialog box and click the **Breakpoints List** link.

- To see a list of all of the breakpoints and their associated conditions, select the **Breakpoints** tab.
- To inspect data and message values, select the **Watch** tab. For more information, see “View Data in the Breakpoints and Watch Window” on page 33-11.

Disable and Reenable Breakpoints

To disable a breakpoint without deleting its associated condition, clear the check box next to the breakpoint name. For example, in this chart, the breakpoint on the During State breakpoint for the `upshifting` state is disabled.

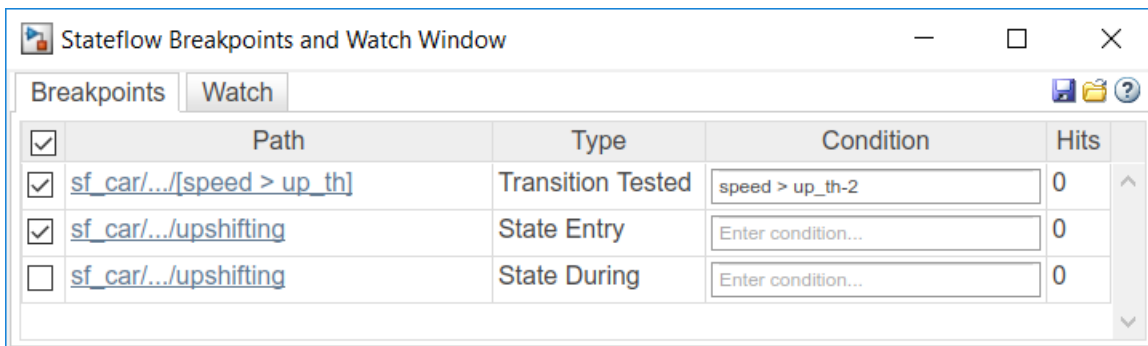

If you disable all the breakpoints for a graphical object, its breakpoint badge changes color from red to gray. If there is at least one breakpoint enabled for an object, the breakpoint badge remains red.

To reenableView a breakpoint, select the box next to the breakpoint name. To disable or reenableView all breakpoints, clear or select the check box at the top of the window.

Remove Breakpoints

To remove a breakpoint from the chart, point to the name of the breakpoint and click the **Remove this breakpoint** icon that appears to the right of the name. When you remove a breakpoint, you also delete its associated condition.

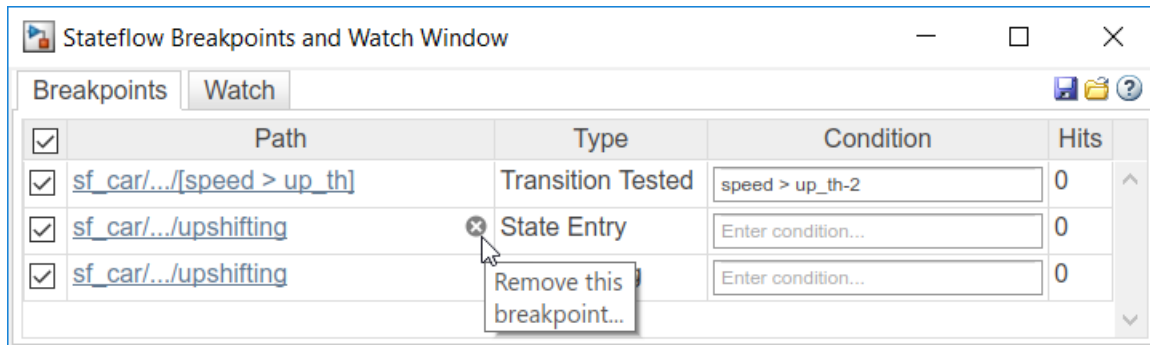

View Breakpoint Hits

The **Hits** column displays the number of times that the simulation has paused on each breakpoint. When you change the condition for a breakpoint, the chart resets the number of hits.

Save and Restore Breakpoints

Breakpoints persist during a MATLAB session. When you close a model, its breakpoints remain in the Breakpoints and Watch window. If you reopen a model during the same MATLAB session, all of the breakpoints and their associated conditions are restored.

You can save the breakpoint and watch data lists and reload them in a later MATLAB session. To save a snapshot of the breakpoint and watch data lists, at the top of the Breakpoints and Watch Window, click the **Save current breakpoints and watches** icon. To restore a snapshot, click the **Load breakpoints and watches** icon.

See Also

More About

- “Debugging Stateflow Charts” on page 33-2
- “Inspect and Modify Data and Messages While Debugging” on page 33-9
- “Control Chart Execution After a Breakpoint” on page 33-16
- “Debug Run-Time Errors in a Chart” on page 33-20

Inspect and Modify Data and Messages While Debugging

While your Stateflow chart is in debugging mode, you can examine the status of the chart by inspecting the values of data, messages, and temporal logic expressions. You can also test the design of the chart by modifying data values and sending local and output messages. This table summarizes the interfaces that you can use to perform these debugging tasks. For more information, see “Debugging Stateflow Charts” on page 33-2.

Debugging Task	Stateflow Editor	Symbols Pane	Breakpoints and Watch Window	MATLAB Command Window
Inspect values of data and messages	Yes on page 33-9	Yes on page 33-10	Yes on page 33-11	Yes on page 33-12
Inspect temporal logic expressions	Yes on page 33-9	No	No	No
Modify values of data and messages	No	Yes on page 33-10	No	Yes on page 33-13
Send messages	No	No	No	Yes on page 33-14

View Data in the Stateflow Editor

While the simulation is paused at a breakpoint, you can examine data values by pointing to a state, transition, or function in the chart. A tooltip displays the value of the data and the messages that the selected object uses.

Object Type	Tooltip Information
States and transitions	Values of data, messages, and temporal logic expressions that the object uses
Graphical, truth table, and MATLAB functions	Values of local data, messages, inputs, and outputs in the scope of the function

For example, the breakpoint in this chart pauses the simulation when the second state evaluates its during actions. Pointing to the superstate gear displays a tooltip that shows the values of:

- Temporal logic expressions `duration(speed >= up_threshold)` and `duration(speed <= down_threshold)`.
- Data, including `speed`, `up_threshold`, and `up`.

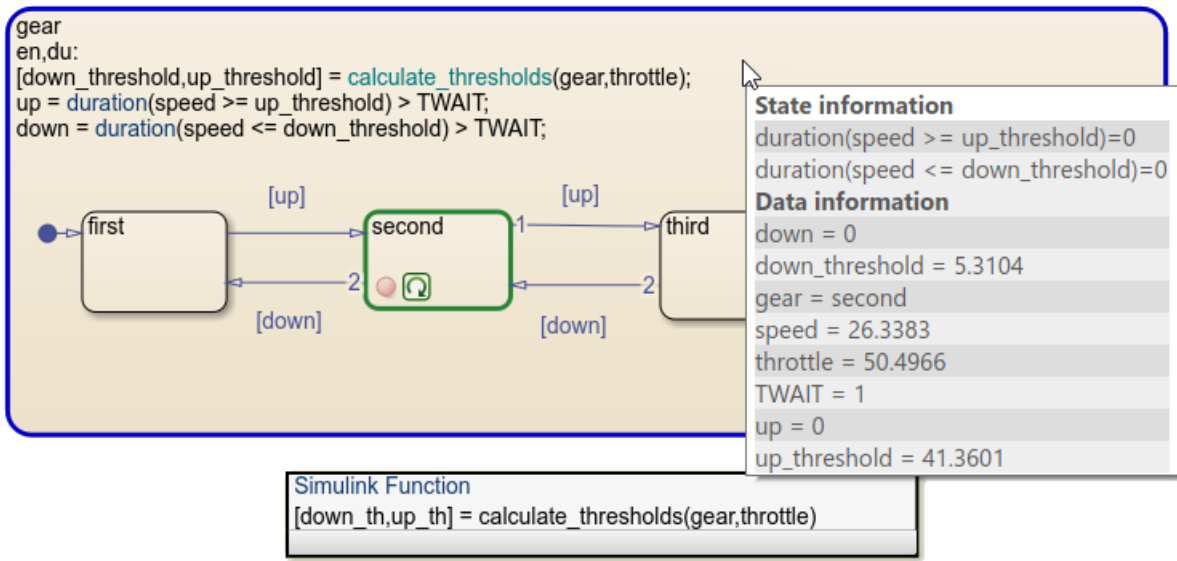

Note If you select the chart properties **Export Chart Level Functions** and **Treat Exported Functions as Globally Visible**, the tooltip does not display temporal logic data.

View and Modify Data in the Symbols Pane

While a chart is in debugging mode, the Symbols pane displays the value of each data and message object in the chart. For example, when this chart pauses at the breakpoint, you can see the values of all chart data listed in the **Value** column. The highlighted values changed during the last time step.

TYPE	NAME	VALUE	PORT
	calculate_thresholds		
	TWAIT	1	
	throttle	50.4966	1
	gear	second	1
	down	0	
	up	0	
	down_threshold	5.3104	
	up_threshold	41.3601	
	speed	26.3383	2

During: State second 80% T=7.080 7% ode5

In the Symbols pane, you can change the value of:

- Data store memory, local, and output data.

- Local and output messages.

Click the **Value** field for a data or message object to enter a new value.

You cannot change the values of constants, parameters, or input data and messages during simulation.

For more information, see “Manage Data, Events, and Messages in the Symbols Pane” on page 34-2.

View Data in the Breakpoints and Watch Window

In the Stateflow Breakpoints and Watch window, you can view current data and message values while the simulation is paused at a breakpoint. To open the Breakpoints and Watch window, on the **Debug** tab, click **Breakpoints List**. Alternatively, open the Breakpoints dialog box and click the **Breakpoints List** link.

- To see a list of all of the breakpoints and their associated conditions, select the **Breakpoints** tab. For more information, see “Manage Breakpoints Through the Breakpoints and Watch Window” on page 33-7.
- To inspect data and message values, select the **Watch** tab.

Track Data in the Watch List

You can use the Breakpoints and Watch window to:

- Add data and message objects to a watch list.
- Track the values that changed since the last time step.
- Expand a message to view the message queue and message data values.

For example, you can add `speed`, `up_threshold`, and `up` to the watch list and track their values as you step through the simulation. The highlighting indicates that the values of `speed` and `up_threshold` changed during the last time step.

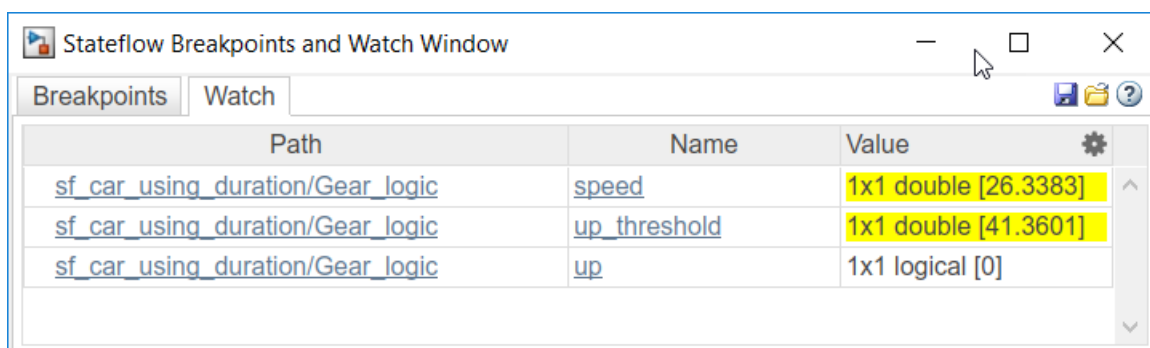

To add a data or message object to the watch list, open the Property Inspector or the Model Explorer. Select the data or message object you want to watch and click the **Add to Watch Window** link.

Alternatively, in the Stateflow Editor, right-click a state or transition that uses the data or message. Select **Add to Watch Window** and choose the variable name from the drop-down list.

Format Watch Display

To change the format used to display watch data, select the gear icon  at the top of the window. Use the drop-down lists to choose a MATLAB format for each data type.

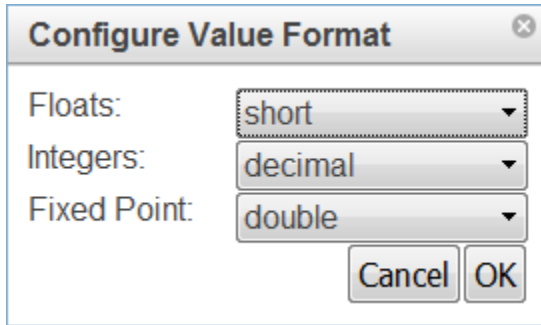

Remove Data from the Watch List

To remove a data or message object from the watch list, point to the path for the watch data and click the **Remove this watch** icon that appears to the left of the variable name.

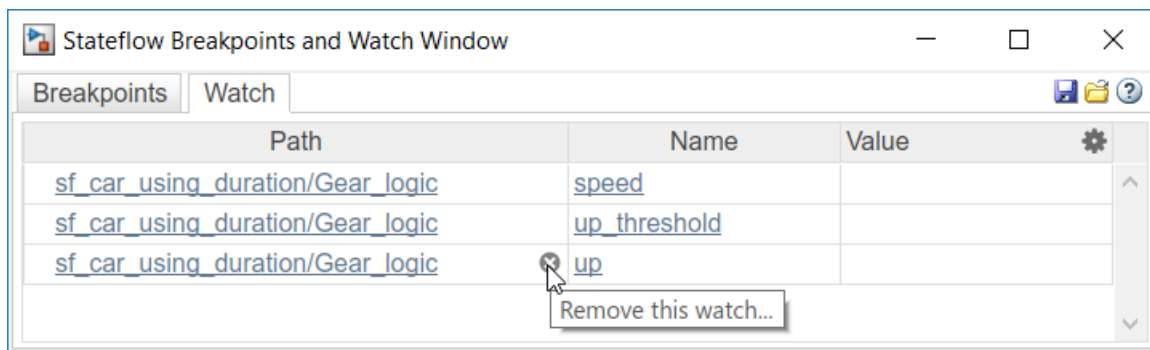

Save and Restore Watch Data

Watch data persists during a MATLAB session. When you close a model, its watch data list remains in the Breakpoints and Watch Window. If you reopen a model during the same MATLAB session, the watch data list for that model is restored.

You can save the breakpoint and watch data lists and reload them in a later MATLAB session. To save a snapshot of the breakpoint and watch data lists, at the top of the Breakpoints and Watch Window, click the **Save current breakpoints and watches** icon. To restore a snapshot, click the **Load breakpoints and watches** icon.

View and Modify Data in the MATLAB Command Window

While the simulation is paused at a breakpoint, the MATLAB command prompt changes to `debug>>`. At this prompt, you can inspect and change the values of Stateflow data, send local and output messages, and interact with the MATLAB workspace.

For example, suppose that the previous chart has reached a breakpoint. To view the data that is visible at the current scope, use the `whos` command.

whos

Name	Size	Bytes	Class	Attributes
TWAIT	1x1	1	uint8	
down	1x1	1	logical	
down_th	1x1	8	double	
down_threshold	1x1	8	double	
gear	1x1	4	gearType	
speed	1x1	8	double	
throttle	1x1	8	double	
up	1x1	1	logical	
up_th	1x1	8	double	
up_threshold	1x1	8	double	

To inspect the values of `speed` and `up_threshold`, enter:

```
speed
```

```
speed =
```

```
    26.3383
```

```
up_threshold
```

```
up_threshold =
```

```
    41.3601
```

Modify Data by Using the Debugging Prompt

At the debugging prompt, you can change the value of data store memory, local, and output data. For example, in the previous chart, you can change the value of `up_threshold`, `up`, and `gear`:

```
up_threshold = 25;
```

```
up = true;
```

```
gear = gearType.third;
```

Follow these rules when modifying data at the debugging prompt.

- To modify vectors and matrices, use MATLAB syntax for indexing, regardless of the action language property of your chart. See “Indexing Notation” on page 18-4.

For example, to change the element in the diagonal of a 2-by-2 matrix `u`, enter:

```
u(1,1) = 6.022e23;
u(2,2) = 6.626e-34
```

- You can change the dimensions of variable-size data as long as the new size is within the dimension bounds specified for the data. For example, suppose that `v` is a variable-size array with a maximum size of `[16 16]`. To change the value of `v` to a 5-by-7 array of ones, enter:

```
v = ones(5,7);
```

- To modify enumerated data, explicitly specify the enumerated type by using prefixed identifiers. See “Notation for Enumerated Values” on page 20-3.

For example, suppose that `w` has an enumerated data type `Colors`. To change the value of `w` to the enumerated value `Red`, enter:

```
w = Colors.Red
```

- To modify numerical data, cast to an explicit data type by using a MATLAB type conversion function. Explicit casting is not required for data of a type `double`. See “Type Cast Operations” on page 13-16.

For example, suppose that `x` has type `single`, `y` has type `int32`, and `z` has type `fixdt(1,16,12)`. To change the value of these data objects, enter:

```
x = single(98.6);
y = int32(100);
z = fi(0.5413,1,16,12);
```

- You cannot change the values of constants, parameters, or input data at the debugging prompt.

Note To modify data of type `int64` or `uint64`, use the function `fi` to cast the new value to a fixed-point type. `int64` is an alias type for `fixdt(1,64,0)` and `uint64` is an alias type for `fixdt(0,64,0)`.

Send Messages by Using the Debugging Prompt

At the debugging prompt, you can send local and output messages. For example, in this chart, the local message `M` determines which state becomes active after the state `DecisionPoint`. If the chart receives the message `M` with a positive value, the state `Received` becomes active and the chart outputs a value of `true`. Otherwise, the state `Missed` becomes active and the chart outputs a value of `false`.

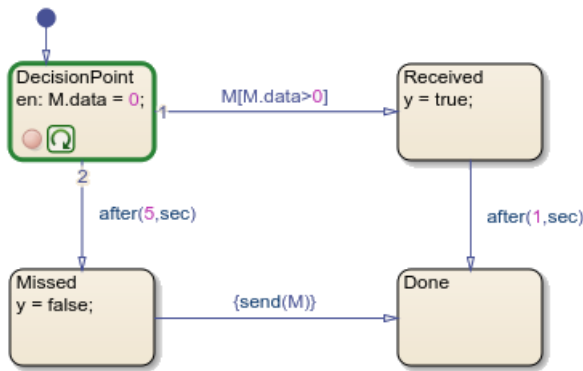

The initial value of the message is zero. To change the value of the data field to a positive number and send the message to its local queue, enter:

```
M = 5;
send(M);
```

When you advance to the next step of the simulation, the message triggers the transition to the state `Received`. For more information, see “Control Chart Execution After a Breakpoint” on page 33-16.

Follow these rules when sending messages from the debugging prompt:

- To read or write to the message data field of a valid message, use the name of the message object. Do not use dot notation syntax.
- You can send a message from the debugging prompt only when the chart explicitly sends the message by calling the `send` operator.

- You cannot send input messages from the debugging prompt.

For more information, see “Control Message Activity in Stateflow Charts” on page 12-9.

Access the MATLAB Workspace While Debugging

You can enter other MATLAB commands at the debugging prompt, but the results are executed in the Stateflow workspace. For example, you can save all of the chart variables in a MAT-file by using the `save` function:

```
save(chartVars)
```

To enter a command in the MATLAB base workspace, use the `evalin` command with the first argument `'base'`. For example, to list the variables in the MATLAB workspace, use the command:

```
evalin('base','whos')
```

See Also

`evalin` | `save` | `send` | `whos`

More About

- “Debugging Stateflow Charts” on page 33-2
- “Set Breakpoints to Debug Charts” on page 33-3
- “Control Chart Execution After a Breakpoint” on page 33-16
- “Manage Data, Events, and Messages in the Symbols Pane” on page 34-2

Control Chart Execution After a Breakpoint

When the simulation of a Stateflow chart pauses at a breakpoint, the chart enters debugging mode. You can examine the state of the chart and step through the simulation. For more information, see “Debugging Stateflow Charts” on page 33-2.

Examine the State of the Chart

When a Stateflow chart enters debugging mode, the editor highlights the active elements in blue and the currently executing object in green. For example, this chart is paused at an entry breakpoint in the HIGH state. The active state (On) is highlighted in blue and the currently executing substate (HIGH) is highlighted in green.

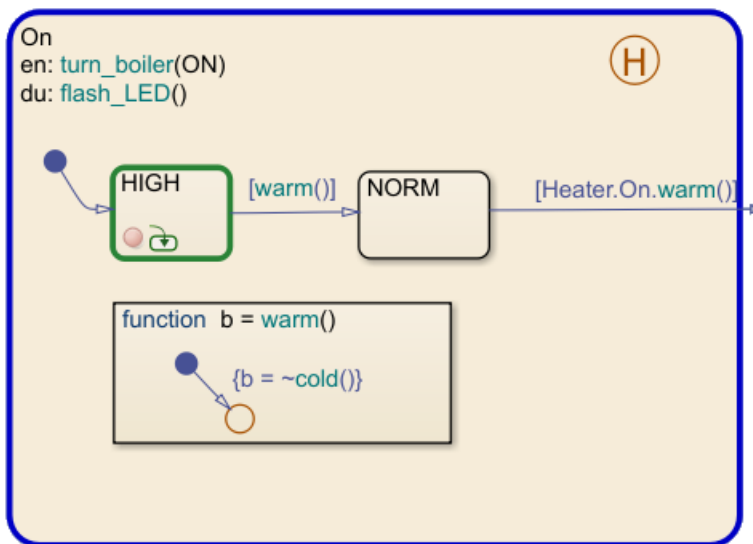

An execution status badge appears in the graphical object where the simulation is paused.

Badge	Description
	Simulation is paused before entering a chart or in a state entry action.
	Simulation is paused in a state during action, graphical function, or truth table function.
	Simulation is paused in a state exit action.
	Simulation is paused before testing a transition.
	Simulation is paused before taking a valid transition.

To see the execution status, point to the badge. A tooltip indicates:

- Where the simulation is paused
- The simulation time
- The current event (if the simulation is paused during a local or input event)

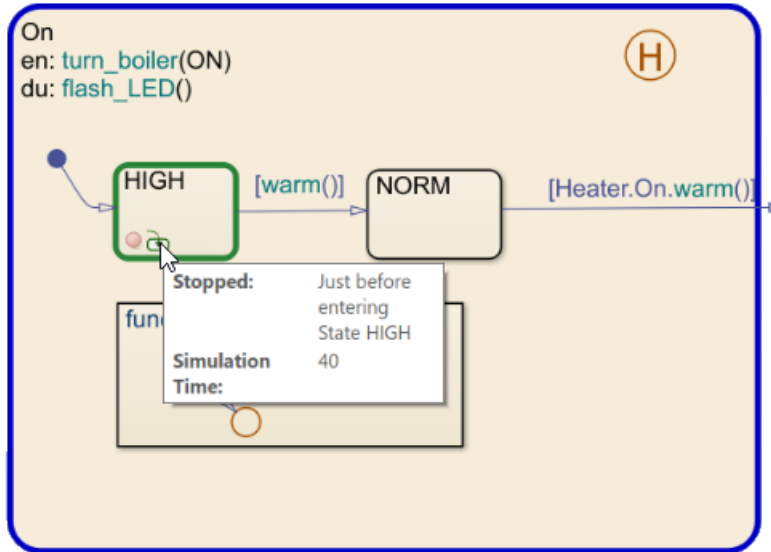

To view the values of chart, point to a chart object. A tooltip displays:

- The values of the data and messages that the selected object uses
- Temporal information (if the object contains a temporal logic operator)

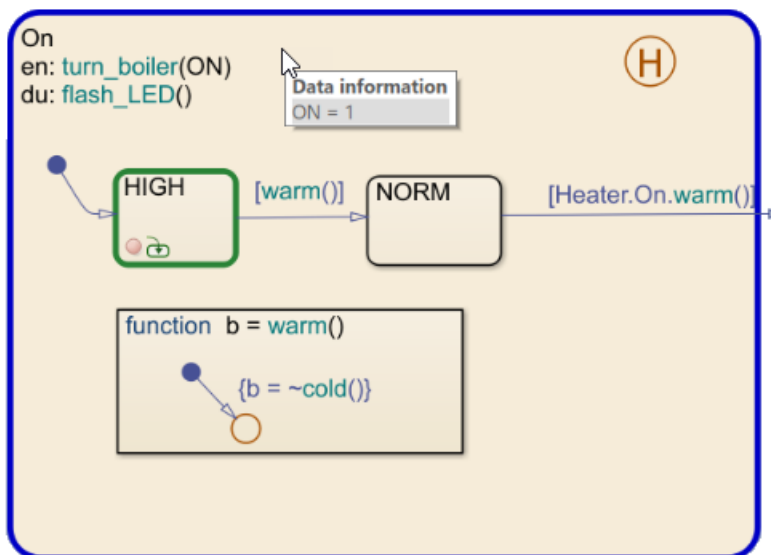

For more information, see “Inspect and Modify Data and Messages While Debugging” on page 33-9.

Step Through the Simulation

When the chart is paused at a breakpoint, you can continue the simulation by using:

- Buttons in the **Debug** tab
- The MATLAB Command Window

- Keyboard shortcuts

Action	Debug Tab Button	MATLAB Command	Keyboard Shortcut	Description
Continue		dbcont	Ctrl+T	Continue simulation to the next breakpoint.
Step Forward				Exit debug mode and pause simulation before next time step.
Step Over		dbstep	F10	Advance to the next step in the chart execution. At the chart level, possible steps include: <ul style="list-style-type: none"> • Enter the chart • Test a transition • Execute a transition action • Activate a state • Execute a state action For more information, see “Execution of a Stateflow Chart” on page 3-23.
Step In		dbstep in	F11	From a state or transition action that calls a function, advance to the first executable statement in the function. From a statement in a function containing another function call, advance to the first executable statement in the second function. Otherwise, advance to the next step in the chart execution. (See Step Over .)
Step Out		dbstep out	Shift+F11	From a function call, return to the statement calling the function. Otherwise, continue simulation to the next breakpoint. (See Continue .)
Run to Cursor				In state or transition actions containing more than one statement, execute a group of statements together.

Action	Debug Tab Button	MATLAB Command	Keyboard Shortcut	Description
Stop		dbquit	Ctrl+Shift+T	Exit debug mode and stop simulation.

In state or transition actions that contain more than one statement, you can step through the individual statements one at a time by selecting **Step Over**. The Stateflow Editor highlights each statement before executing it.

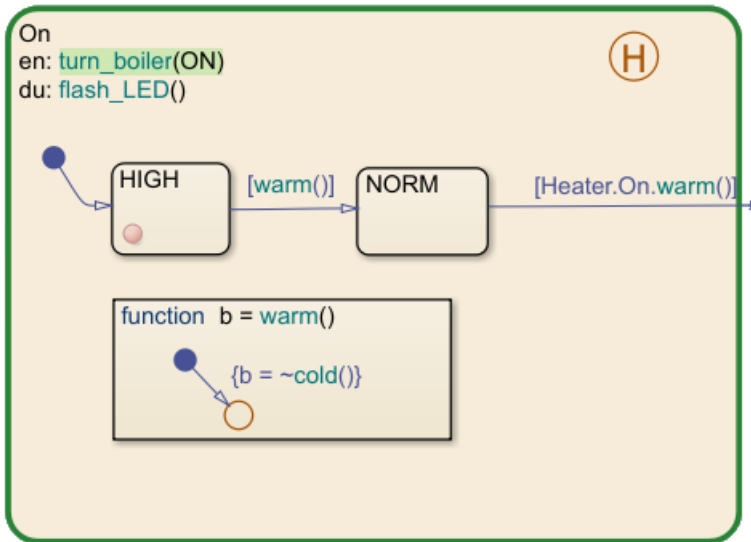

To execute a group of statements together, click the last statement in the group and select **Run to Cursor**.

See Also

More About

- “Debugging Stateflow Charts” on page 33-2
- “Set Breakpoints to Debug Charts” on page 33-3
- “Inspect and Modify Data and Messages While Debugging” on page 33-9
- “Debug Run-Time Errors in a Chart” on page 33-20

Debug Run-Time Errors in a Chart

In this section...

“Create the Model and the Stateflow Chart” on page 33-20

“Debug the Stateflow Chart” on page 33-21

“Correct the Run-Time Error” on page 33-21

Create the Model and the Stateflow Chart

In this topic, you create a Simulink model with a Stateflow chart to debug. Follow these steps:

- 1 Create the following Simulink model:

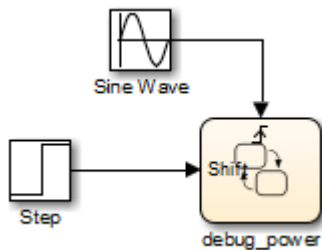

- 2 Add the following states and transitions to your chart:

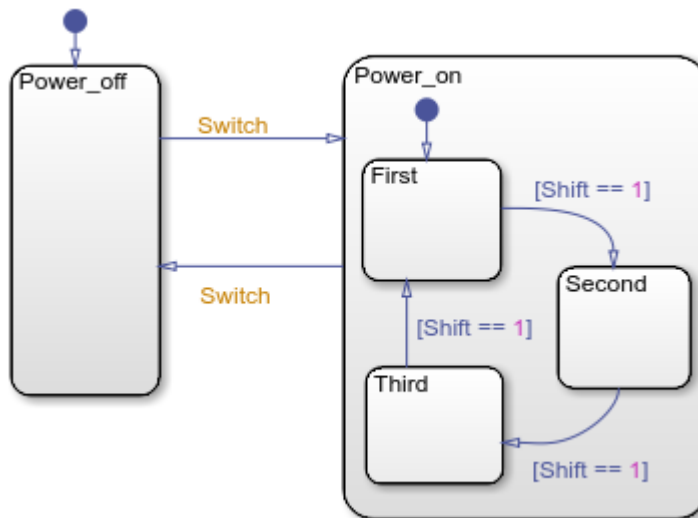

- 3 In your chart, add an event Switch with a scope of **Input from Simulink** and a **Rising** edge trigger.
- 4 Add a data Shift with a scope of **Input from Simulink**.

The chart has two states at the highest level in the hierarchy, `Power_off` and `Power_on`. By default, `Power_off` is active. The event `Switch` toggles the system between the `Power_off` and `Power_on` states. `Power_on` has three substates: `First`, `Second`, and `Third`. By default, when `Power_on` becomes active, `First` also becomes active. When `Shift` equals 1, the system transitions from

First to Second, Second to Third, Third to First, for each occurrence of the event `Switch`, and then the pattern repeats.

In the model, there is an event input and a data input. A Sine Wave block generates a repeating input event that corresponds with the Stateflow event `Switch`. The Step block generates a repeating pattern of 1 and 0 that corresponds with the Stateflow data object `Shift`. Ideally, the `Switch` event occurs at a frequency that allows at least one cycle through `First`, `Second`, and `Third`.

Debug the Stateflow Chart

To debug the chart in “Create the Model and the Stateflow Chart” on page 33-20, follow these steps:

- 1 Right-click in the chart, and select **Set Breakpoint on Chart Entry**.
- 2 Start the simulation.

Because you specified a breakpoint on chart entry, execution stops at that point.

- 3 Click the Step In button, .

The Step In button executes the next step and stops.

- 4 Continue clicking the Step In button and watching the animating chart.

After each step, watch the chart animation to see the sequence of execution.

Single-stepping shows that the chart does not exhibit the desired behavior. The transitions from `First` to `Second` to `Third` inside the state `Power_on` are not occurring because the transition from `Power_on` to `Power_off` takes priority. The output display of code coverage also confirms this observation.

Correct the Run-Time Error

In “Debug the Stateflow Chart” on page 33-21, you step through a simulation of a chart and find an error: the event `Switch` drives the simulation but the simulation time passes too quickly for the input data object `Shift` to have an effect.

Correct this error as follows:

- 1 Stop the simulation so that you can edit the chart.
- 2 Add the condition `[t > 20.0]` to the transition from `Power_on` to `Power_off`.

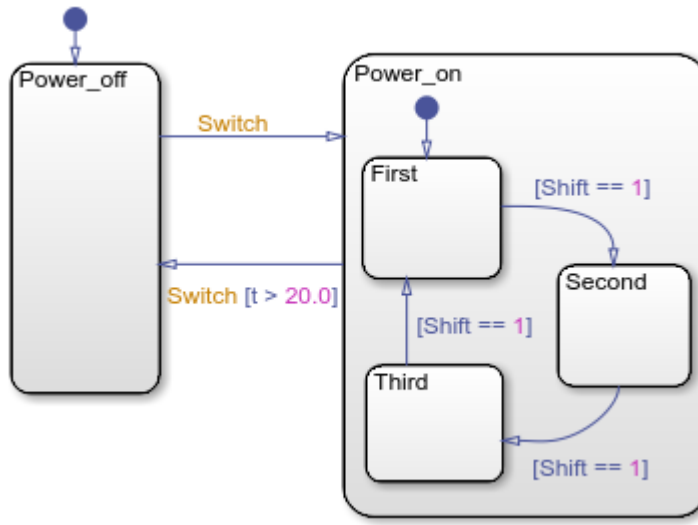

Now the transition from **Power_on** to **Power_off** does not occur until simulation time is greater than 20.0.

- 3** Begin simulation again.
- 4** Click the Step In button repeatedly to observe the new behavior.

Animate Stateflow Charts

Set Animation Speeds

During simulation, animation provides visual verification that your chart behaves as you expect. Animation highlights active objects in a chart as execution progresses. For charts in a Simulink model, you can control the speed of chart animation during simulation, or turn off animation. In the Stateflow Editor, in the **Debug** tab, under **Animation Speed**:

- Lightning Fast
- Fast
- Medium
- Slow
- None

Lightning Fast animation provides the fastest simulation speed by buffering the highlights. During **Lightning Fast** animation, the more recently highlighted objects are in a bolder, lighter blue. These highlights fade away as simulation time progresses.

The default animation speed, **Fast**, shows the active highlights at each time step. To add a delay with each time step, set the animation speed to **Medium** or **Slow**.

Maintain Highlighting

To maintain highlighting of active states in the chart after simulation ends, in the **Debug** tab, select **Maintain highlighting of active states after simulation ends** .

Disable Animation

Animation is enabled by default in Stateflow charts. To turn off animation for a chart, in the **Debug** tab, select **Remove animation highlighting** .

Animate Charts as Generated Code Executes on a Target System

If you have Simulink Coder, you can use external mode to establish communication between a Simulink model and generated code downloaded to and executing on a target system. Stateflow software can use the external mode communication channel to animate chart states. Also, you can designate chart data of local scope to be test points and view the test point data in floating scopes and signal viewers.

For more information, see:

- “External Mode Simulation by Using XCP Communication” (Simulink Coder)
- “External Mode Simulation with TCP/IP or Serial Communication” (Simulink Coder)

Detect Modeling Errors During Edit Time

When edit-time checking is enabled, the Stateflow Editor detects potential errors and warnings as you work on your chart. By fixing these issues early in the design process, you can avoid compile-time or run-time warnings and errors.

The Stateflow editor highlights objects that violate the edit-time checks in red (for errors) or orange (for warnings). When you point to an object that is highlighted and click the error or warning badge, a tooltip displays details and possible fixes.

Manage Edit-Time Checks

By default, edit-time checking and syntax error highlighting are enabled. To disable the edit-time checks, in the **Debug** tab, clear the **Diagnostics > Edit-Time Errors & Warnings** check box.

This table lists edit-time checks that have an associated diagnostic configuration parameter on the **Diagnostics > Stateflow** pane of the Configuration Parameters dialog box.

Edit-Time Check Issue	Diagnostic Configuration Parameter
"Dangling Transition" on page 33-26	"Unreachable execution path" (Simulink)
"Default Transition Path Does Not Terminate in a State" on page 33-26	"No unconditional default transitions" (Simulink)
"Transition Action Precedes a Condition Action Along This Path" on page 33-28	"Transition action specified before condition action" (Simulink)
"Transition Loops Outside Natural Parent" on page 33-29	"Transition outside natural parent" (Simulink)
"Transition Shadowing" on page 33-30	"Unreachable execution path" (Simulink)
"Unconditional Path Out of State with During Actions or Child States" on page 33-30	"Transition outside natural parent" (Simulink)
"Unexpected Backtracking" on page 33-32	"Unexpected backtracking" (Simulink)
"Unreachable Junction" on page 33-33	"Unreachable execution path" (Simulink)

You can control the level of diagnostic action for these edit-time checks by setting the value of their configuration parameter to **error**, **warning**, or **none**. When you change the setting for a configuration parameter, the diagnostic level for the corresponding edit-time checks also changes. For example, if you set the **Unreachable execution path** configuration parameter to **none**, then the Stateflow Editor does not highlight dangling transitions, transition shadowing, or unreachable states.

Edit-Time Checks on States

Invalid Intersection

- **Issue:** States and junctions must not overlap in the Stateflow Editor.
- **Diagnostic level:** Error.
- **Solution:** Avoid intersections by separating the states and junctions.

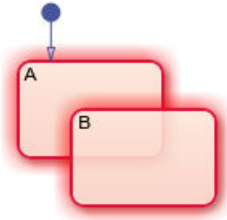

Monitoring Leaf or Child State Activity of Parallel States

- **Issue:** Charts and states with parallel (AND) decomposition do not support monitoring of leaf or child state activity because parallel substates are active simultaneously.
- **Diagnostic level:** Warning.
- **Solution:** Open the Property Inspector or the Model Explorer. Clear the **Create output for monitoring** check box or select **Self** activity from the drop-down list. For more information, see “Monitor State Activity Through Active State Data” on page 10-2.

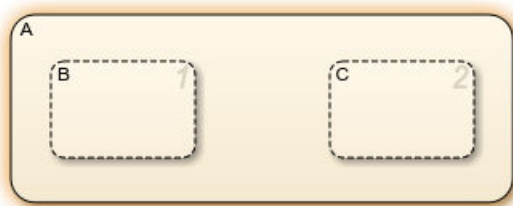

Object Contains a Syntax Error

- **Issue:** A state action does not follow the Stateflow syntax rules. The Stateflow Editor underlines syntax errors with a red, wavy line.
- **Diagnostic level:** Error.
- **Solution:** Correct the syntax error in the state action. For more information, see “State Labels” on page 2-10.

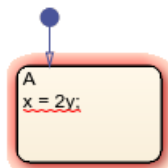

Note In the parent chart, subcharts with syntax errors are highlighted in red and an error badge indicates the syntax issue. In the subchart editor, the syntax error is underlined in red, but there is no badge to indicate the issue.

Unreachable State

- **Issue:** A state is unreachable when no valid execution path leads to it.
- **Diagnostic level:** Depends on the configuration parameter “Unreachable execution path” (Simulink).

- **Solution:** Connect the unreachable state with a transition from a reachable state or junction.



Edit-Time Checks on Transitions

Dangling Transition

- **Issue:** Every transition must have a valid destination state or junction.
- **Diagnostic level:** Depends on the configuration parameter “Unreachable execution path” (Simulink).
- **Solution:** Connect the transition to a state or junction. For more information, see “Transitions” on page 2-18.



Default Transition Is Missing

- **Issue:** In a chart or state with exclusive (OR) decomposition and at least two substates or junctions, a default transition is required to indicate where the execution begins.
- **Diagnostic level:** Error.
- **Solution:** Specify an initial state by adding a default transition. For more information, see “Default Transitions” on page 2-28.



Default Transition Path Does Not Terminate in a State

- **Issue:** In charts or states with exclusive (OR) decomposition and at least one substate:
 - Every path along the default transition must lead to a substate.
 - There must be one default transition path that is not guarded by a condition or triggered by an event.
- **Diagnostic level:** Depends on the configuration parameter “No unconditional default transitions” (Simulink).
- **Solution:** Terminate every path along the default transition in a substate. Ensure that one default transition path is not guarded by a condition or triggered by an event.

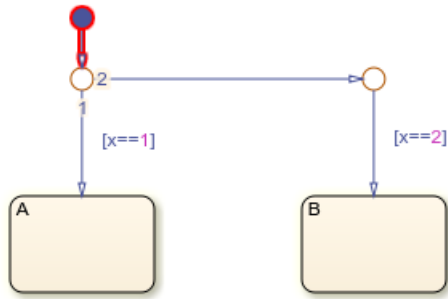

Invalid Default Transition Path

- **Issue:** A default transition path must not exit the parent state.
- **Diagnostic level:** Error.
- **Solution:** Modify the default transition path so it stays within the parent state.

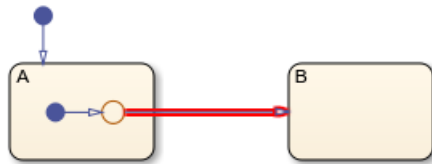

Invalid Transitions Crossing into Graphical Function

- **Issue:** Transitions must not enter a graphical function. Stateflow charts call graphical functions from state actions or transitions.
- **Diagnostic level:** Error.
- **Solution:** Delete the transition entering the graphical function.

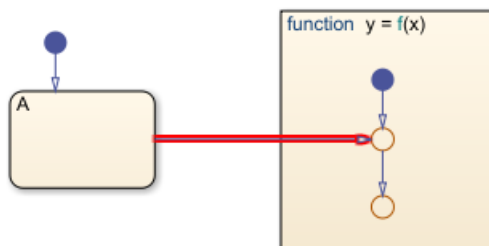

Object Contains a Syntax Error

- **Issue:** In a transition, a condition or action does not follow the Stateflow syntax rules. The Stateflow Editor underlines syntax errors with a red, wavy line.
- **Diagnostic level:** Error.
- **Solution:** Correct the syntax error in the transition condition or action. For more information, see "Transition Label Notation" on page 2-19.

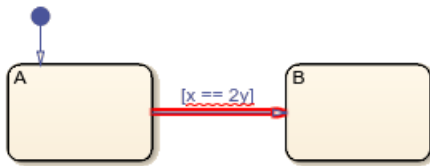

Transition Action Precedes a Condition Action Along This Path

- **Issue:** When a transition with a transition action is followed by a transition with a condition action, the actions are not executed in the order of the transitions. Stateflow charts execute condition actions when the associated condition is evaluated as true. In contrast, charts execute transition actions only when the transition path is fully executed. As a consequence, a chart takes a transition path, the condition actions occur before the transition actions.
- **Diagnostic level:** Depends on the configuration parameter “Transition action specified before condition action” (Simulink).
- **Solution:** Place the transition action after the last condition action on the path.

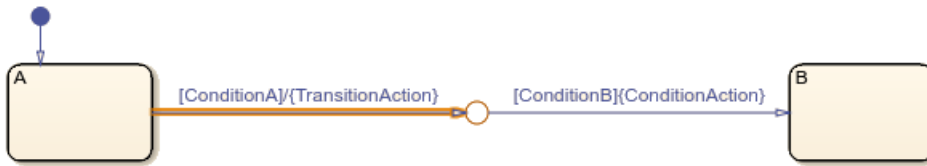

Transition Begins or Ends in a Parallel State

- **Issue:** In charts and states with parallel (AND) decomposition, all sibling states are active or inactive at the same time.
- **Diagnostic level:** Warning.
- **Solution:** Remove the transitions or change the decomposition of the parent state to exclusive (OR).

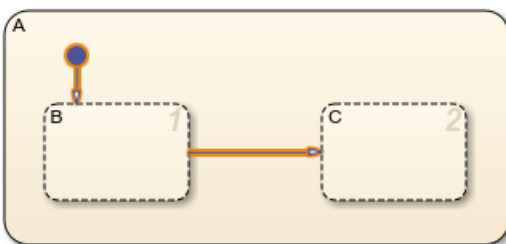

Transition Connects to a Box

- **Issue:** Transitions can only connect to states and junctions.
- **Diagnostic level:** Error.
- **Solution:** Move or delete the transitions attached to the box.

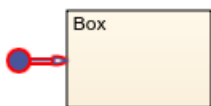

Transition Crosses Parallel States

- **Issue:** Standalone Stateflow charts do not support transitions that cross the boundary of a parallel state.
- **Diagnostic level:** Error.
- **Solution:** Delete the transition crossing into or out of the parallel states.

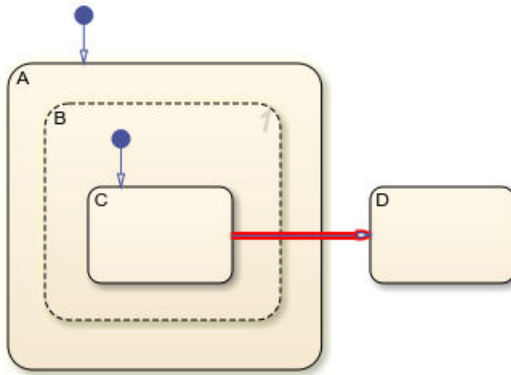

Transition Enters or Exits Graphical Function

- **Issue:** Transitions must not exit a graphical function. Flow charts in graphical functions must be completely contained inside the function.
- **Diagnostic level:** Error.
- **Solution:** Delete the transition exiting the graphical function.

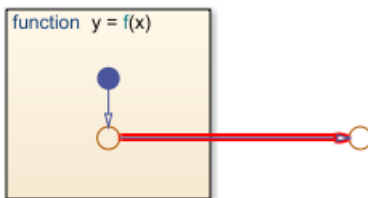

Transition Loops Outside Natural Parent

- **Issue:** If a transition goes outside the parent state between the source and destination, the chart executes the exit and entry actions of the parent state before the destination state becomes active.
- **Diagnostic level:** Depends on the configuration parameter "Transition outside natural parent" (Simulink).
- **Solution:** Move the transition so that it is contained within the parent state.

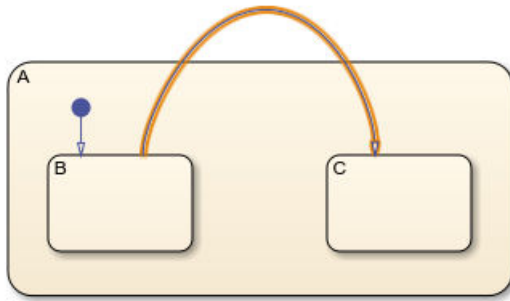

Transition Shadowing

- **Issue:** When an unconditional transition executes before other outgoing transitions from the same source, it prevents the other transitions from executing.
- **Diagnostic level:** Depends on the configuration parameter “Unreachable execution path” (Simulink).
- **Solution:** Create no more than one unconditional transition from each state or junction. Explicitly specify that the unconditional transition executes after any transitions with conditions. For more information, see “Transition Evaluation Order” on page 3-38.

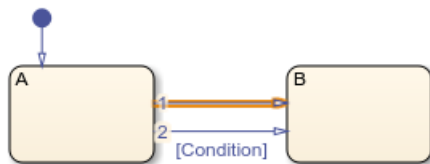

Unconditional Path Out of State with During Actions or Child States

- **Issue:** Unconditional transitions leading out of a state inhibit the execution of the during actions in the state and the default transitions to child states.
- **Diagnostic level:** Depends on the configuration parameter “Transition outside natural parent” (Simulink).
- **Solution:** Add a condition to the transition or remove during actions and child states from the state.

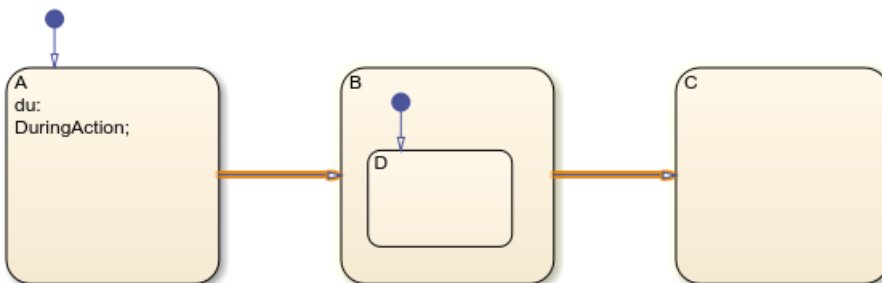

Edit-Time Checks on Junctions

Cycle Contains Transitions with Transition Actions

- **Issue:** Cycles should not contain transitions with transition actions.
- **Diagnostic level:** Error.
- **Solution:** Remove the transition action or remove the cycle by deleting a transition.

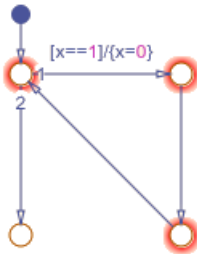

Invalid History Junction

- **Issue:** A history junction is invalid when:
 - The history junction is contained in the chart level of the hierarchy.
 - The history junction is contained in a state with parallel (AND) decomposition.
 - The history junction is contained inside a graphical function.
 - There are multiple history junctions contained in the same state.
 - The history junction is the source of a transition.
- **Diagnostic level:** Error.
- **Solution:** Remove the history junction from the chart level of the hierarchy, a state with parallel (AND) decomposition, or a graphical function. Remove all but one history junction from the state. Move the transition source to a connective junction or a state. For more information, see “Record State Activity by Using History Junctions” on page 8-2.

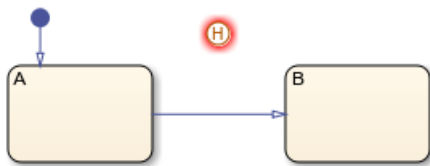

Junction Has No Unconditional Escape from Cycle

- **Issue:** A junction must have an unconditional escape path from a cycle to a state or terminating junction.
- **Diagnostic level:** Error.
- **Solution:** Create an unconditional path from the junction to a state or terminating junction.

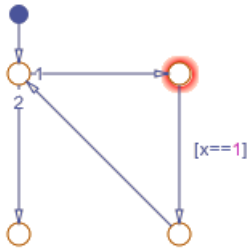

Unexpected Backtracking

- **Issue:** Unintended backtracking of control flow can occur when:
 - Multiple transition paths from the same source lead to a junction.
 - The junction does not have an unconditional path to a state or terminating junction.
- **Diagnostic level:** Depends on the configuration parameter “Unexpected backtracking” (Simulink).
- **Solution:** Create an unconditional path from the junction to a state or terminating junction. For more information, see “Backtrack in Flow Charts” on page B-30.

For example, the highlighted junction in this chart does not have an unconditional transition path to state A. If ConditionA and ConditionB are true and ConditionC is false, the chart backtracks to the first junction in the path multiple times. As a result, the chart executes the three condition actions.

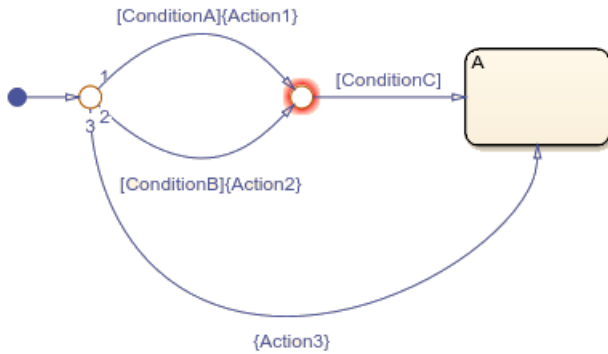

To avoid backtracking, combine the conditions and create an unconditional path from the second junction to the destination state. After the change, the chart executes only one condition action.

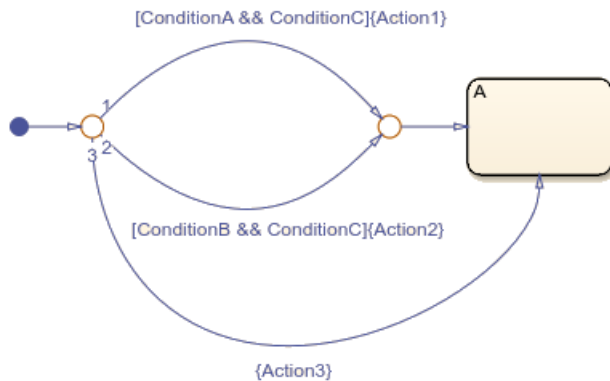

Unreachable Junction

- **Issue:** A junction is unreachable when no valid execution path leads to it.
- **Diagnostic level:** Depends on the configuration parameter “Unreachable execution path” (Simulink).
- **Solution:** Connect the unreachable junction with a transition from a reachable state or junction.

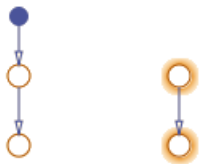

Edit-Time Checks on Functions

Function is Unused

- **Issue:** A function is unused when a chart when there are no statements that call the function.
- **Diagnostic level:** Warning.
- **Solution:** Call the function from a state or transition action or from another function.

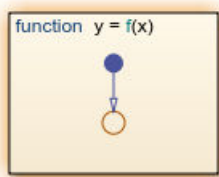

Graphical Function Contains a State

- **Issue:** Because graphical functions execute completely in a single time step, they must not contain any states.
- **Diagnostic level:** Error.
- **Solution:** Replace the states with junctions. For more information, see “Reuse Logic Patterns by Defining Graphical Functions” on page 8-13.

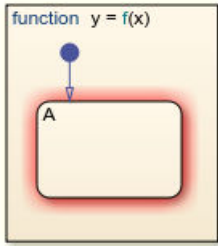

Invalid Use of Keywords as Function Arguments

- **Issue:** A function definition uses a reserved keyword as an argument.
- **Diagnostic level:** Error.
- **Solution:** Rename the argument to the function. For a list of reserved keywords, see “Rules for Naming Stateflow Objects” on page 2-5.

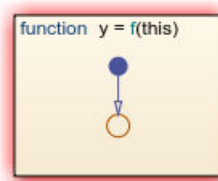

See Also

More About

- “Detect Common Modeling Errors During Chart Simulation” on page 33-35
- “Modeling Guidelines for Stateflow Charts” on page 3-19
- “Stateflow Semantics” on page 3-2
- “Model Configuration Parameters: Stateflow Diagnostics” (Simulink)

Detect Common Modeling Errors During Chart Simulation

To avoid common design errors, you can run diagnostic checks that test the completeness of your Stateflow chart during compilation and simulation. Stateflow diagnostics detect state inconsistencies, violations in data ranges, and cyclic behavior in Stateflow charts in Simulink models.

When you simulate a model, Stateflow automatically parses the Stateflow machine. The parser evaluates the graphical and nongraphical objects and data in each Stateflow machine against the supported chart notation and the action language syntax. You can also check the syntax of your chart by selecting **Update Chart** in the **Modeling** tab of the Stateflow Toolstrip.

If syntax errors exist in your chart, the chart automatically appears with the highlighted object that causes the first error. You can select the error in the diagnostic window to bring its source chart to the front with the source object highlighted. Any unresolved data or events in the chart are flagged in the Symbol Wizard.

State Inconsistencies

In a Stateflow chart, states are inconsistent if they violate one of these rules:

- An active state with exclusive (OR) decomposition and at least one substate has exactly one active substate.
- All substates of an active state with parallel (AND) decomposition are active.
- All substates of an inactive state are inactive regardless of the state decomposition.

While you edit your chart, the Stateflow Editor displays potential causes for state inconsistencies by highlighting objects in red or orange. For more information, see “Detect Modeling Errors During Edit Time” on page 33-24.

Causes of State Inconsistency

One type of state inconsistency occurs when all of these conditions are true:

- A state with multiple substates has exclusive (OR) decomposition.
- The state does not contain a history junction.
- Every default path that leads to a substate is guarded by a condition or triggered by an event.
- Not all transitions into the state are supertransitions leading directly to a substate.

For example, this chart has a state inconsistency because there is no default transition to indicate which substate becomes active first.

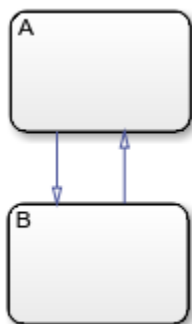

Adding an unconditional default transition to one of the states resolves the state inconsistency.

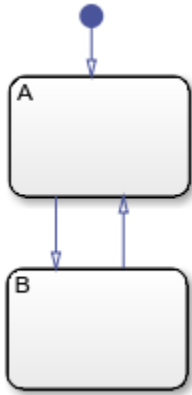

Detect State Inconsistencies

At compile time, Stateflow charts detect state inconsistencies caused by the omission of an unconditional default transition. To control the level of diagnostic action, open the Model Configuration Parameters dialog box. In the **Diagnostics > Stateflow** pane, for the diagnostic **No unconditional default transitions**, you can select error, warning, or none. The default setting is error. For more information, see “No unconditional default transitions” (Simulink).

Data Range Violations

During simulation, a data range violation occurs when:

- An integer or fixed-point operation overflows the numeric capacity of its result type. See “Handle Integer Overflow for Chart Data” on page 9-36 and “Fixed-Point Operations in Stateflow Charts” on page 23-19.
- The value of a data object is outside the range of the values specified by the **Initial value**, **Minimum**, and **Maximum** properties. See “Initial Value” on page 9-8 and “Limit Range” on page 9-9.

For example, this chart contains local data **a** that has a **Minimum** value of 0 and a **Maximum** value of 2. The entry action in state A initializes **a** to 1. The during action increments the value of **a** by 1. After two time steps, the value of **a** exceeds its specified range, resulting in a data range violation.

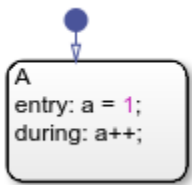

Detect Data Range Violations

At run time, Stateflow charts detect data range violations. To control the level of diagnostic action, open the Model Configuration Parameters dialog box. In the **Diagnostics > Data Validity** pane, you can select error, warning, or none for these diagnostics:

- **Simulation range checking** detects violations based on minimum-and-maximum range checks. The default setting is none.
- **Wrap on overflow** and **Saturate on overflow** detect violations that occur when integer or fixed-point operations exceed the numeric capacity of their result type. The default setting is warning.

For more information, see “Simulation range checking” (Simulink), “Wrap on overflow” (Simulink), and “Saturate on overflow” (Simulink).

Cyclic Behavior

Cyclic behavior occurs when a step or sequence of steps is repeated indefinitely during chart simulation.

For example, the actions in this chart produce an infinite cycle of recursive event broadcasts.

- The during action in state C broadcasts the event E1.
- The event E1 triggers the transition from state A.A1 to state A.A2. The condition action for this transition broadcasts the event E2.
- The event E2 triggers the transition from state B.B1 to state B.B2. The condition action for this transition broadcasts the event E1.

The event broadcasts in states A and B occur in condition actions, so the transitions do not take place until the chart processes the resulting events. The substates A.A1 and B.B1 remain active, so new event broadcasts continue to trigger the transitions and the process repeats indefinitely.

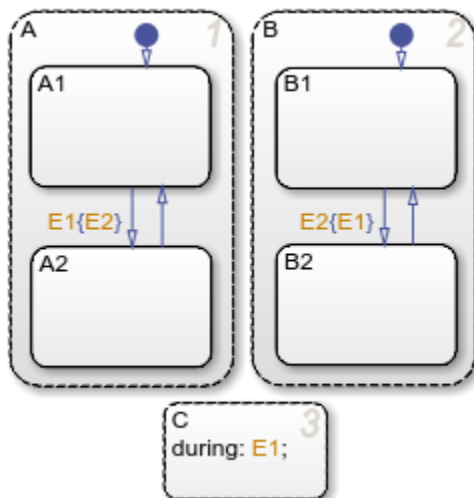

Because undirected local event broadcasts can cause unwanted recursive behavior, use of the **send** operator to broadcast directed local events is recommended. For more information, see “Broadcast Local Events to Synchronize Parallel States” on page 13-37.

Detect Cyclic Behavior During Simulation

During chart simulation, Stateflow charts use cycle detection algorithms to detect a class of infinite recursions caused by event broadcasts. To enable cycle detection, open your Stateflowchart. In the **Debug** tab, select **Diagnostics > Detect Cyclical Behavior**. Cyclic behavior checking is selected by default.

Stateflow charts also detect undirected local event broadcasts. To control the level of diagnostic action, open the Model Configuration Parameters dialog box. In the **Diagnostics > Stateflow** pane, for the **Undirected event broadcasts** diagnostic, you can select **error**, **warning**, or **none**. The default setting is **warning**. For more information, see “Undirected event broadcasts” (Simulink).

Limitations of Cyclic Behavior Detection

Stateflow cycle detection is limited to cases of recursion due to event broadcasts and does not extend to other types of cyclic behavior.

For instance, Stateflow cannot detect the infinite cycle in this flow chart. In this example, the default transition initializes the local data `i` to 0. The next transition segment increments `i`. The transition to the terminating junction is valid only when the condition `[i < 0]` is true. Because this condition is never true, an infinite cycle results.

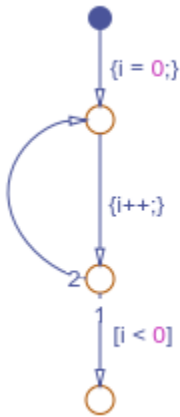

The model `sf_cycle_error_fix` provides suggestions for fixing cyclic behavior in flow charts. At the MATLAB command prompt, enter:

```
sfhelp('cycle_error');
```

See Also

More About

- “Detect Modeling Errors During Edit Time” on page 33-24
- “Model Configuration Parameters: Stateflow Diagnostics” (Simulink)

Avoid Unwanted Recursion in a Chart

Recursion can be useful for controlling substate transitions among parallel states at the same level of the chart hierarchy. For example, you can send a directed event broadcast from one parallel state to a sibling parallel state to specify a substate transition. This type of recursive behavior is desirable and efficient. For details, see “Broadcast Local Events to Synchronize Parallel States” on page 13-37.

However, unwanted recursion can also occur during chart execution. To avoid unwanted recursion, do not use recursive function calls or undirected local event broadcasts.

Recursive Function Calls

Suppose that you have functions named *f*, *g*, and *h* in a chart. These functions can be any combination of graphical functions, truth table functions, MATLAB functions, or Simulink functions.

To avoid recursive behavior, do not:

- Have *f* calling *g* calling *h* calling *f*.
- Have *f*, *g*, or *h* calling itself.

Undirected Local Event Broadcasts

Examples of state actions with undirected local event broadcasts include:

- `entry: send(E1)`, where *E1* is a local event in the chart.
- `exit: E2`, where *E2* is a local event in the chart.

To avoid recursive behavior, replace undirected event broadcasts with directed event broadcasts by using the syntax

```
send(event, state)
```

where *event* is a local event in the chart and *state* is a destination state.

- If the local event broadcast occurs in a state action, ensure that the destination state is not an ancestor of the source state in the chart hierarchy.
- If the local event broadcast occurs in a transition, ensure that:
 - The destination state is not an ancestor of the transition in the chart hierarchy.
 - The transition does not connect to the destination state.

During simulation, Stateflow charts can detect undirected local event broadcasts. To control the level of diagnostic action, open the Model Configuration Parameters dialog box. In the **Diagnostics > Stateflow** pane, for the **Undirected event broadcasts** diagnostic, you can select `none`, `warning`, or `error`. The default setting is `warning`. For more information, see “Undirected event broadcasts” (Simulink).

See Also

`send`

More About

- “Broadcast Local Events to Synchronize Parallel States” on page 13-37
- “Detect Common Modeling Errors During Chart Simulation” on page 33-35
- “Model Configuration Parameters: Stateflow Diagnostics” (Simulink)

Monitor Test Points in Stateflow Charts

This example shows you how to specify data or states as test points that you can plot with a floating scope or log to the MATLAB® base workspace during simulation.

About Test Points in Stateflow Charts

A Stateflow® test point is a signal that you can observe during simulation, for example, by using a Floating Scope block. You can designate states or local data with these properties as test points:

- **Size** - scalar, one-dimensional, or two-dimensional
- **Type** - any data type except `m1`
- **Location** - descendant of a Stateflow chart

You can specify individual data or states as test points by setting their **TestPoint** property via the Stateflow API, in the Property Inspector, or in the Model Explorer.

You can monitor individual Stateflow test points with a floating scope during model simulation. You can also log test point values into MATLAB workspace objects.

You can also use active state output to view or log state activity data in Simulink®. For more information, see “Monitor State Activity Through Active State Data” on page 10-2.

Set Test Points for Stateflow States and Data with the Property Inspector

You can explicitly set individual states, local data, and output data as test points in the Model Explorer. The following procedure shows how to set individual test points for Stateflow states and data.

1. Open the model.

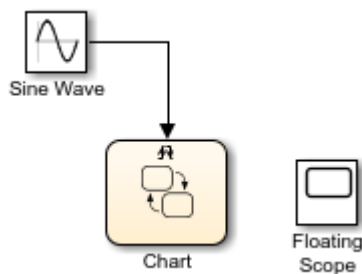

In the Stateflow chart, state A and its substate X are entered on the first `tic` event. State A and substate X stay active until 10 `tic` events have occurred, and then state B is entered. On the next event, state A and substate X are entered and the cycle continues. The data `data` belongs to substate X. The entry and during actions for substate X increment `data` while X is active for 10 `tic` events. When state B is entered, `data` reinitializes to zero, and then the cycle repeats.

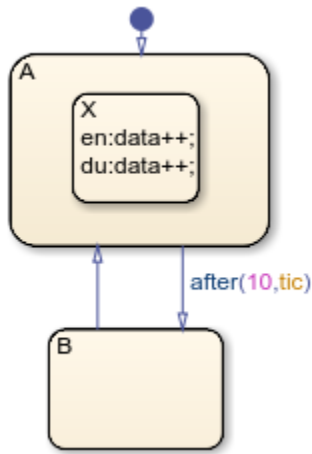

2. Open the Property Inspector, **View > Property Inspector**.
3. Select state A. Then, in the **Logging** section of the Property Inspector, select **Test Point**.
4. Repeat this for state X and B.
5. Open the Symbol viewer, **View > Symbols**.
6. Select the data data. Then, in the **Logging** section of the Property Inspector, select **Test Point**.

You can also log these test points. For instructions, see “Log Multiple Signals” on page 33-46.

Monitor Data Values and State Self Activity Using a Floating Scope

In this section, you configure a Floating Scope block to monitor a data value and the self activity of a state.

1. Open the model.

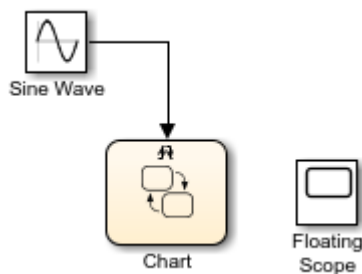

2. Double-click the Floating Scope block.
3. In the Floating Scope window, select **Simulation > Signal Selector**.
4. In the **Model hierarchy** pane, select the chart and in the **List contents**, select the signals.

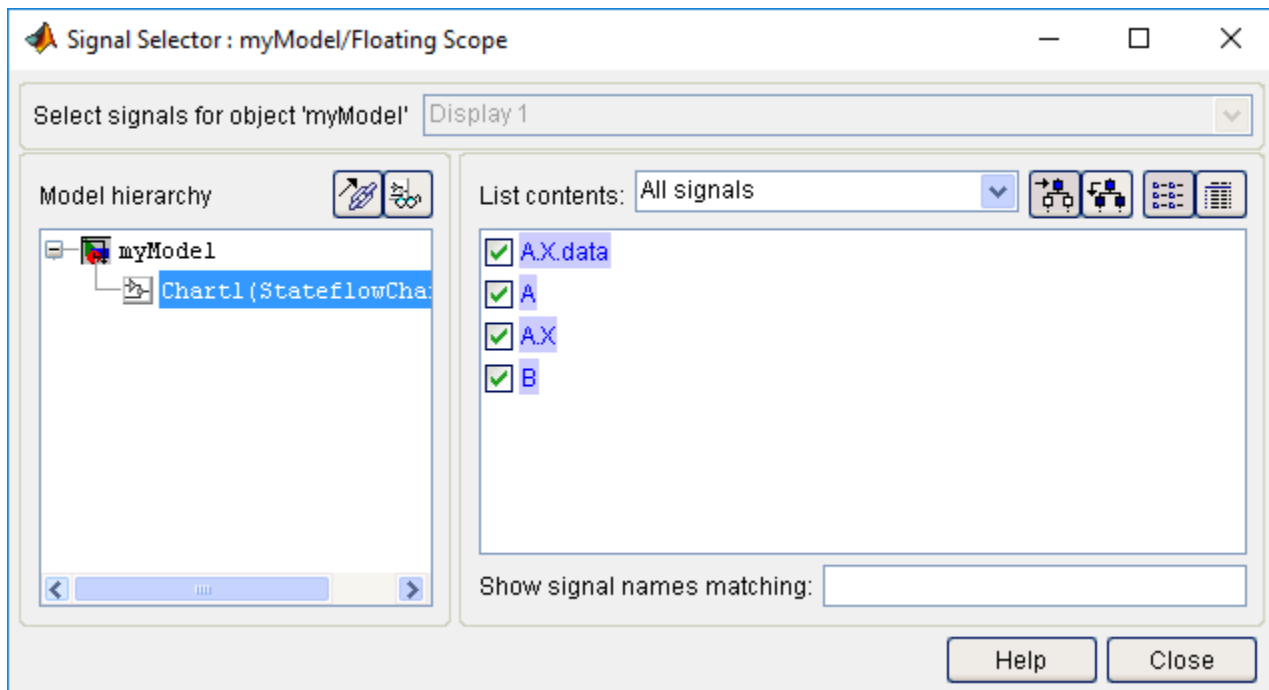

5. Simulate the model.

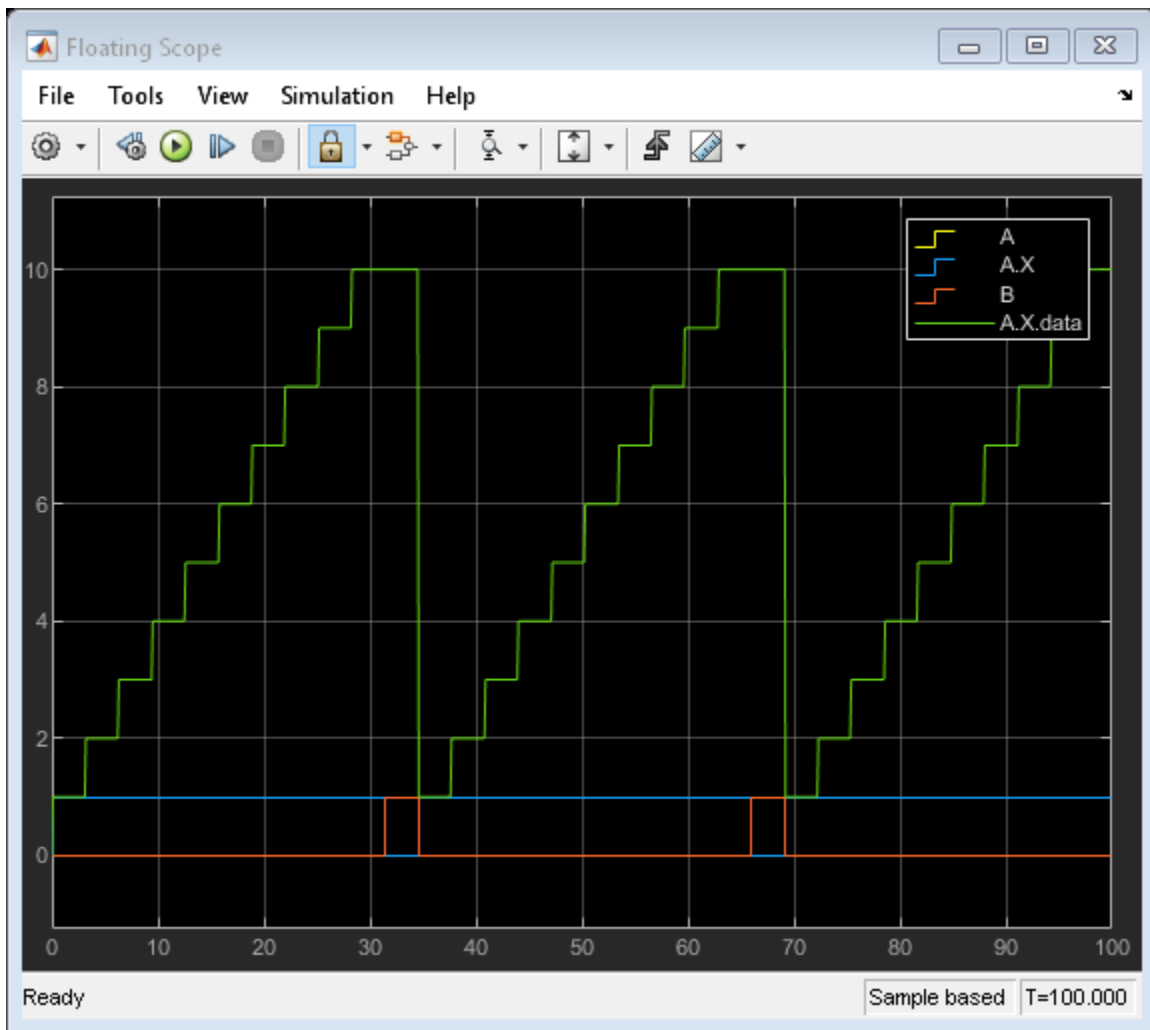

When state A.X is active, the signal value is 1. When that state is inactive, the signal value is 0. Because this value can be very low or high compared to other data, you might want to add a second Floating Scope block to compare the activity signal with other data.

See Also

More About

- “Configure Signals as Test Points” (Simulink)

Log Simulation Output for States and Data

When you simulate a Stateflow chart in a Simulink model, you can log values for local, output, and active state data into a `Simulink.SimulationData.Dataset` object. After simulation, you can access this object through the Simulation Data Inspector or in the MATLAB workspace. The workflow for logging data is:

- 1 Enable signal logging for the chart and choose a logging format. See “Enable Signal Logging” on page 33-45.
- 2 Configure states and data for signal logging. See “Configure States and Data for Logging” on page 33-45.
- 3 Simulate the chart.
- 4 Access the logged data. See “Access Signal Logging Data” on page 33-48.

Enable Signal Logging

Signal logging is enabled by default for models and charts. To disable or reenabling signal logging:

- 1 Open the Model Configuration Parameters dialog box.
- 2 Select **Data Import/Export**.
- 3 In the **Signals** pane, select the **Signal logging** check box to enable logging for the chart. To disable logging, clear the check box.
- 4 (Optional) Specify a custom name for the signal logging object. The default name is `logout`. Using this object, you can access the logging data in a MATLAB workspace variable. For more information, see “Export Signal Data Using Signal Logging” (Simulink).
- 5 (Optional) In the **Format** field, select a signal logging format. Options include:
 - Array
 - Structure
 - Structure with time
 - Dataset

The default setting is `Dataset`. For more information, see “Time, State, and Output Data Format” (Simulink).

- 6 Click **OK**.

Configure States and Data for Logging

You can set logging properties for states, local data, and output data from inside the chart, through the Stateflow Signal Logging dialog box, or programmatically from the command line.

Log Individual States and Data

Configure logging properties for one state or data object at a time through the Property Inspector, the Model Explorer, or the properties dialog box for the state or data object. Select the **Logging** tab and modify properties as needed. For more information, see “Logging Properties” on page 9-15.

For example, in the `sf_semantics_hotel_checkin` model:

- 1 Open the Hotel chart.
- 2 Open the Symbols pane. In the **Simulation** tab, in **Prepare**, click **Symbols Pane**.
- 3 Open the Property Inspector. In the **Simulation** tab, in **Prepare**, click **Property Inspector**.
- 4 Configure the service local data for logging.
 - a In the Symbols pane, select service.
 - b In the Property Inspector, under **Logging**, select the **Log signal data** check box.
- 5 Configure the Dining_area state for logging.
 - a On the Stateflow Editor, select the Dining_area state.
 - b In the **Simulation** tab, in **Prepare**, select **Log Self Activity**. Alternatively, in the Property Inspector, under **Logging**, select the **Log self activity** check box.
 - c By default, the logging name for this state is the hierarchical signal name Check_in.Checked_in.Executive_suite.Dining_area. To assign a shorter name to the state, set **Logging Name** to Custom and enter Dining Room.

Log Multiple Signals

Configure logging properties for multiple states and data objects through the Stateflow Signal Logging dialog box. Select which chart objects to log from a list of all states, local, and output data. For more information, see “Logging Properties” on page 9-15.

For example, in the sf_semantics_hotel_checkin model:

- 1 Open the Hotel chart.
- 2 To log multiple signals, press and hold shift to select the states for logging. In the **Simulation** tab, under **Prepare**, select **Log Self Activity**.
- 3 The logging badge  marks logged signals in the model.

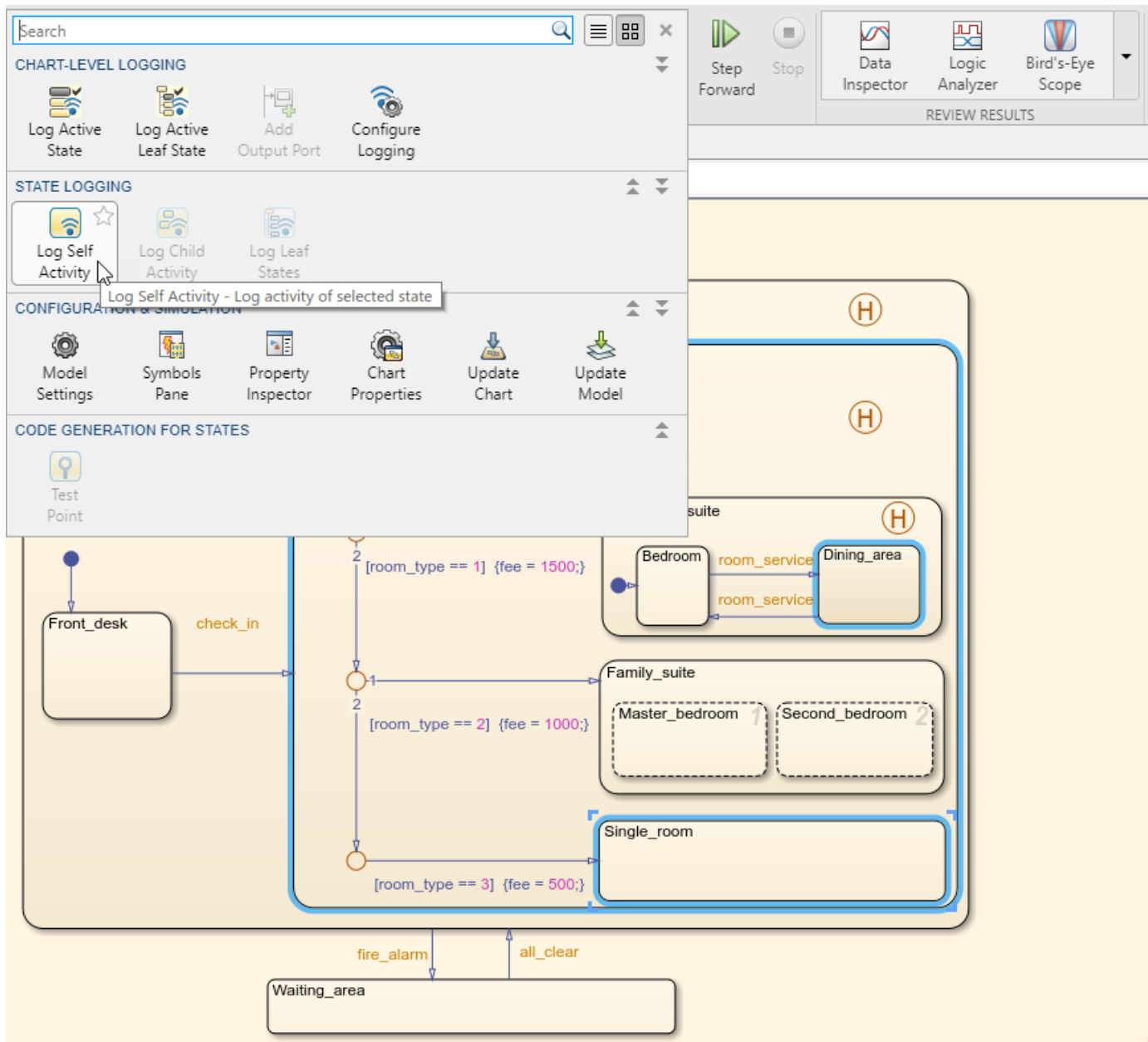

Add an Output Port

You can add an output port to monitor chart activity. From the Stateflow Editor, in the **Simulation** tab, click **Add Output Port**. A new port appears on your Stateflow chart. Connect this port to a viewer to monitor the chart child activity.

Log Chart Signals by Using the Command-Line API

Configure logging properties for states and data objects programmatically from the command line. To enable logging for a states or data object, get a handle for the object and set its `LoggingInfo.DataLogging` property to 1. For more information on the Stateflow Programmatic Interface, see “Logging”.

For example, in the `sf_semantics_hotel_checkin` model:

1 Open the Hotel chart.

2 Get a handle for the Dining_area state:

```
rt = sfroot;
diningState = rt.find('-isa','Stateflow.State','Name','Dining_area');
```

3 Get a handle for the local data service:

```
serviceData = rt.find('-isa','Stateflow.Data','Name','service');
```

4 Enable logging for the Dining_area state and the service data:

```
diningState.LoggingInfo.DataLogging = 1;
serviceData.LoggingInfo.DataLogging = 1;
```

5 Change the logging name of the Dining_area state to the custom name Dining Room:

```
% Enable custom naming
diningState.LoggingInfo.NameMode = 'Custom';

% Enter the custom name
diningState.LoggingInfo.LoggingName = 'Dining Room';
```

Access Signal Logging Data

During simulation, Stateflow saves logged data in a `Simulink.SimulationData.Dataset` signal logging object.

For example, suppose that you configure the `sf_semantics_hotel_checkin` model to log the service local data and the activity of the Dining_area state. After starting the simulation, you check into the hotel by toggling the first switch and order room service multiple times by toggling the second switch. After stopping the simulation, you can view the logged data through the Simulation Data Inspector or in the MATLAB workspace.

View Logged Data Through the Simulation Data Inspector

When you simulate the model, the **Simulation Data Inspector** icon is highlighted to indicate that it has new simulation data.

1

To open the Simulation Data Inspector, in the **Simulation** tab, click the icon .

2 Inspect and compare the signals logged during simulation. See Simulation Data Inspector.

View Logged Data in the MATLAB Workspace

1 To access the signal logging object, at the MATLAB command prompt, enter:

```
logout = out.logout
```

```
logout =
```

```
Simulink.SimulationData.Dataset 'logout' with 2 elements
```

	Name	BlockPath
1	[1x1 State]	Dining Room
2	[1x1 Data]	service

2 To access logged elements, use the `get` method. You can access logged elements by name, index, or block path.

```
diningLog = logout.get('Dining Room')
diningLog =
    Stateflow.SimulationData.State
    Package: Stateflow.SimulationData

    Properties:
        Name: 'Dining Room'
        BlockPath: [1x1 Simulink.SimulationData.BlockPath]
        Values: [1x1 timeseries]
```

```
serviceLog = logout.get('service')
serviceLog =
    Stateflow.SimulationData.Data
    Package: Stateflow.SimulationData

    Properties:
        Name: 'service'
        BlockPath: [1x1 Simulink.SimulationData.BlockPath]
        Values: [1x1 timeseries]
```

- 3** To access the logged data and time of each logged element, use the `Values.Data` and `Values.Time` properties. For example:

- Arrange logged data in tabular form by using the `table` function.

```
T1 = table(diningLog.Values.Time,diningLog.Values.Data);
T1.Properties.VariableNames = {'Time','Data'}
```

```
T1 =
```

```
6x2 table
```

Time	Data
0	0
1.8607e+06	1
1.9653e+06	0
1.9653e+06	1
1.9653e+06	0
2.2912e+06	1

```
T2 = table(serviceLog.Values.Time,serviceLog.Values.Data);
T2.Properties.VariableNames = {'Time','Data'}
```

```
T2 =
```

```
6x2 table
```

Time	Data
1.7076e+06	0
1.8607e+06	1
1.9653e+06	2
1.9653e+06	3

```
1.9653e+06    4
2.2912e+06    5
```

- View logged data in a figure window by using the `plot` function.

```
X = serviceLog.Values.Time;
Y = serviceLog.Values.Data;
plot(X,Y,'-o')
xlabel('Time')
ylabel('Data')
```

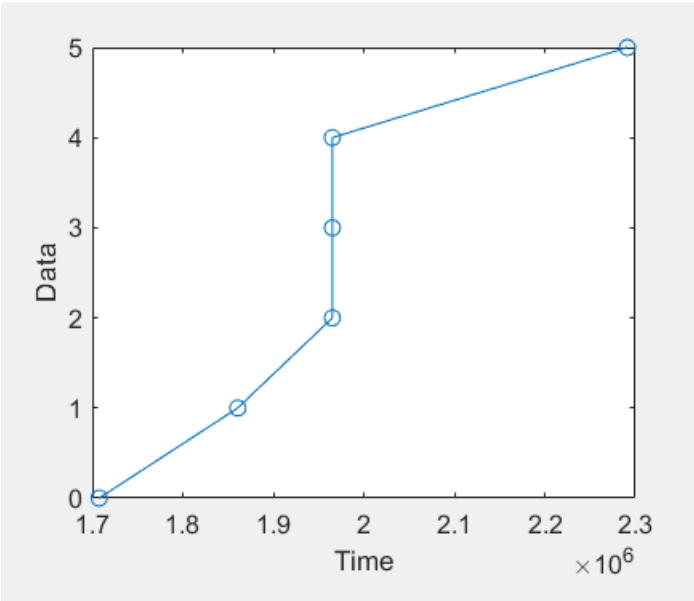

- Export logged data to an Excel® spreadsheet by passing an array of logged values to the `xlswrite` function:

```
A = [double(diningLog.Values.Time) double(diningLog.Values.Data)];
xlswrite('dining_log.xls',A);
```

Log Multidimensional Data

Stateflow logs each update to a multidimensional signal as a single change. For example, updating two elements of a matrix `A` separately

```
A[1][1] = 1;
A[1][2] = 1;
```

produces two different changes in the logged data. In contrast, updating a matrix `A` in a single command

```
A = 1;
```

produces a single change in the logged data, even though the command implies $A[i][j] = 1$ for all values of i and j .

Limitations on Logging Data

When simulating models in external mode, logging of Stateflow data is not supported.

If you log state activity or data from a chart with **Fast Restart** enabled, any run after the first run duplicates the first logged data points. When you run algorithms that process these data points, you must account for this duplication.

See Also

`Simulink.SimulationData.Dataset` | `Stateflow.SimulationData.Data` | `Stateflow.SimulationData.State` | `get` | `plot` | `table` | `xlswrite`

More About

- “Configure a Signal for Logging” (Simulink)
- “Logging and Accessibility Options” (Simulink)
- “Export Signal Data Using Signal Logging” (Simulink)

Log Data in Library Charts

In Simulink, you can create your own block libraries as a way to reuse the functionality of blocks or subsystems in one or more models. Similarly, you can reuse a set of Stateflow algorithms by encapsulating the functionality in a library chart.

As with other Simulink block libraries, you can specialize each instance of chart library blocks in your model to use different data types, sample times, and other properties. Library instances that inherit the same properties can reuse generated code.

For more information about Simulink block libraries, see “Custom Libraries” (Simulink).

How Library Log Settings Influence Linked Instances

Chart instances inherit logging properties from the library chart to which they are linked. You can override logging properties in the instance, but only for signals you select in the library. You cannot select additional signals to log from the instance.

Override Logging Properties in Chart Instances

To override properties of logged signals in chart instances, use one of the following approaches.

Approach	How To Use
Simulink Signal Logging Selector dialog box	See “Override Logging Properties with the Logging Selector” on page 33-52
Command-line interface	See “Override Logging Properties with the Command-Line API” on page 33-53

Override Logging Properties in Atomic Subcharts

The model `sf_atomic_sensor_pair` simulates a redundant sensor pair as atomic subcharts `Sensor1` and `Sensor2` in the chart `RedundantSensors`. Each atomic subchart contains instances of the states `Fail`, `FailOnce`, and `OK` from the library chart `sf_atomic_sensor_lib`.

Override Logging Properties with the Logging Selector

- 1 Open the example library `sf_atomic_sensor_lib`.
- 2 Unlock the library. In the **Simulation** tab, click **Locked Library**.
- 3 In the Simulink Editor, select the Stateflow `SingleSensor` chart. In the **Simulation** tab, click **Log States from List**.
- 4 In Stateflow Signal Logging dialog box, set the following logging properties, then click **OK**.

For Signal:	What to Specify:
Fail	<ul style="list-style-type: none"> • Select the Log signal data check box. • Change Logging name to the custom name <code>LogFail</code>. • Click Apply.

For Signal:	What to Specify:
FailOnce	<ul style="list-style-type: none"> Select the Log signal data check box. Change Logging name to the custom name LogFailOnce. Click Apply.
OK	<ul style="list-style-type: none"> Select the Log signal data check box. Change Logging name to the custom name LogOK. Click Apply.

- Open the model `sf_atomic_sensor_pair`. This model contains two instances of the library chart.
- Open the Model Configuration Parameters dialog box.
- In the **Data Import/Export** pane, click **Configure Signals to Log** to open the Simulink Signal Logging Selector.
- In the **Model Hierarchy** pane, expand `RedundantSensors`, and click `Sensor1` and `Sensor2`.

Each instance inherits logging properties from the library chart. For example:

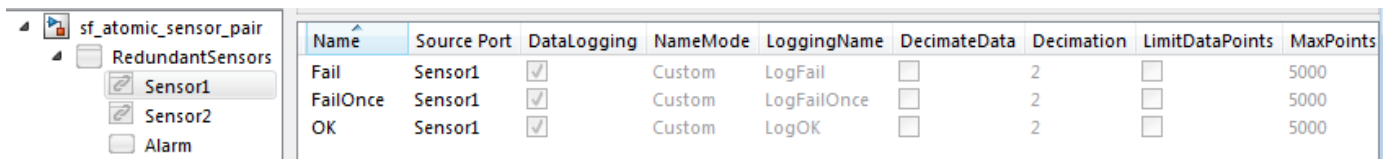

Name	Source Port	DataLogging	NameMode	LoggingName	DecimateData	Decimation	LimitDataPoints	MaxPoints
Fail	Sensor1	<input checked="" type="checkbox"/>	Custom	LogFail	<input type="checkbox"/>	2	<input type="checkbox"/>	5000
FailOnce	Sensor1	<input checked="" type="checkbox"/>	Custom	LogFailOnce	<input type="checkbox"/>	2	<input type="checkbox"/>	5000
OK	Sensor1	<input checked="" type="checkbox"/>	Custom	LogOK	<input type="checkbox"/>	2	<input type="checkbox"/>	5000

- Now, override some logging properties for `Sensor1`:
 - In the **Model Hierarchy** pane, select `Sensor1`.
 - Change **Logging Mode** to `Override signals`.

The selector clears all **DataLogging** check boxes for the model.

- Enable logging only for the `Fail` and `FailOnce` states in `Sensor1`:

Select **DataLogging** for these two signals. Leave **DataLogging** cleared for the `OK` signal.

- Append the text `Sensor1` to the logging names for `Fail` and `FailOnce`:

Double-click the logging names for signals `Fail` and `FailOnce`, and rename them `LogFailSensor1` and `LogFailOnceSensor1`, respectively.

The settings should look like this:

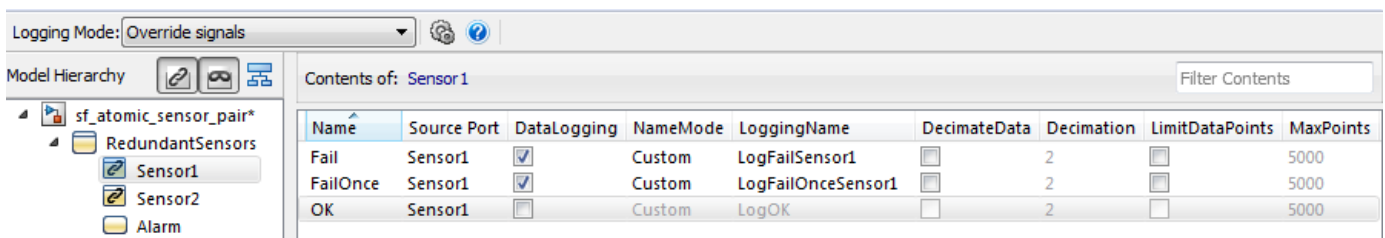

Name	Source Port	DataLogging	NameMode	LoggingName	DecimateData	Decimation	LimitDataPoints	MaxPoints
Fail	Sensor1	<input checked="" type="checkbox"/>	Custom	LogFailSensor1	<input type="checkbox"/>	2	<input type="checkbox"/>	5000
FailOnce	Sensor1	<input checked="" type="checkbox"/>	Custom	LogFailOnceSensor1	<input type="checkbox"/>	2	<input type="checkbox"/>	5000
OK	Sensor1	<input type="checkbox"/>	Custom	LogOK	<input type="checkbox"/>	2	<input type="checkbox"/>	5000

Override Logging Properties with the Command-Line API

- Open the example library `sf_atomic_sensor_lib`.

- 2 Log the signals Fail, FailOnce, and OK in the SingleSensor chart using these commands:

```
% Get states in the SingleSensor chart
rt=sfroot;
states = rt.find('-isa', 'Stateflow.State');

% Enable logging for each state
for i = 1: length(states)
    states(i).LoggingInfo.DataLogging = 1;
end
```

- 3 Open the model sf_atomic_sensor_pair. This model contains two instances of the library chart.
- 4 Create a ModelLoggingInfo object for the model.

This object contains a vector Signals that stores all logged signals.

```
mi = Simulink.SimulationData.ModelLoggingInfo. ...
    createFromModel('sf_atomic_sensor_pair')
```

The result is:

```
mi =
Simulink.SimulationData.ModelLoggingInfo
Package: Simulink.SimulationData

Properties:
    Model: 'sf_atomic_sensor_pair'
    LoggingMode: 'OverrideSignals'
    LogAsSpecifiedByModels: {}
    Signals: [1x6 Simulink.SimulationData.SignalLoggingInfo]
```

The Signals vector contains the signals marked for logging in the library chart:

- Library instances of Fail, FailOnce, and OK states in atomic subchart Sensor1
 - Library instances of Fail, FailOnce, and OK states in atomic subchart Sensor2
- 5 Make sure that LoggingMode equals 'OverrideSignals'.
 - 6 Create a block path to each logged signal whose properties you want to override.

To access signals inside Stateflow charts, use `Simulink.SimulationData.BlockPath(paths, subpath)`, where subpath represents a signal inside the chart.

To create block paths for the signals Fail, FailOnce, and OK in the atomic subchart Sensor1 in the RedundantSensors chart:

```
failPath = Simulink.SimulationData. ...
BlockPath('sf_atomic_sensor_pair/RedundantSensors/Sensor1','Fail')

failOncePath = Simulink.SimulationData. ...
BlockPath('sf_atomic_sensor_pair/RedundantSensors/Sensor1','FailOnce')

OKPath = Simulink.SimulationData. ...
BlockPath('sf_atomic_sensor_pair/RedundantSensors/Sensor1','OK')
```

- 7 Get the index of each logged signal in the `Simulink.SimulationData.BlockPath` object.

To get the index for the signals Fail, FailOnce, and OK:

```
failIdx = mi.findSignal(failPath);
failOnceIdx = mi.findSignal(failOncePath);
OKIdx = mi.findSignal(OKPath);
```

8 Override some logging properties for the signals in Sensor1:**a** Disable logging for signal OK:

```
mi.Signals(OKidx).LoggingInfo.DataLogging = 0;
```

b Append the text Sensor1 to the logging names for Fail and FailOnce:

```
% Enable custom naming
mi.Signals(failidx).LoggingInfo.NameMode = 1;
mi.Signals(failOnceidx).LoggingInfo.NameMode = 1;

% Enter the custom name
mi.Signals(failidx).LoggingInfo.LoggingName = 'LogFailSensor1';
mi.Signals(failOnceidx).LoggingInfo.LoggingName = 'LogFailOnceSensor1';
```

9 Apply the changes:

```
set_param(bdroot, 'DataLoggingOverride', mi);
```

See Also

[Simulink.SimulationData.BlockPath](#) | [Simulink.SimulationData.ModelLoggingInfo](#)

Commenting Stateflow Objects in a Chart

In this section...

“Comment Out a Stateflow Object” on page 33-56

“How Commenting Affects the Chart and Model” on page 33-56

“Add Text to a Commented Object” on page 33-58

“Limitations on Commenting Objects” on page 33-58

Comment Out a Stateflow Object

Commenting out a Stateflow object excludes it from simulation. To comment out a Stateflow object, right-click the object and select **Comment Out**. Use commenting to:

- Debug a chart by making minor changes between simulation runs.
- Test and verify the effects of objects on simulation results.
- Create incremental changes for rapid, iterative design.

How Commenting Affects the Chart and Model

A commented object is not visible to the rest of the chart and the model. Commented objects in a chart are excluded from:

- Simulation
- Logging
- Code generation
- Animation
- Debugging
- Active state output

When a chart is parsed, references to commented functions or states result in errors.

When you explicitly comment out a Stateflow object with **Comment Out**, the object appears gray

with a badge . The software implicitly comments out some associated objects. Implicitly commented objects also appear gray, but do not have a badge. For example, if you explicitly comment out a state or junction, all incoming and outgoing transitions are implicitly commented out. In this image of `sf_car`, the state `steady_state` is explicitly commented. The transitions in and out of `steady_state` are implicitly commented.

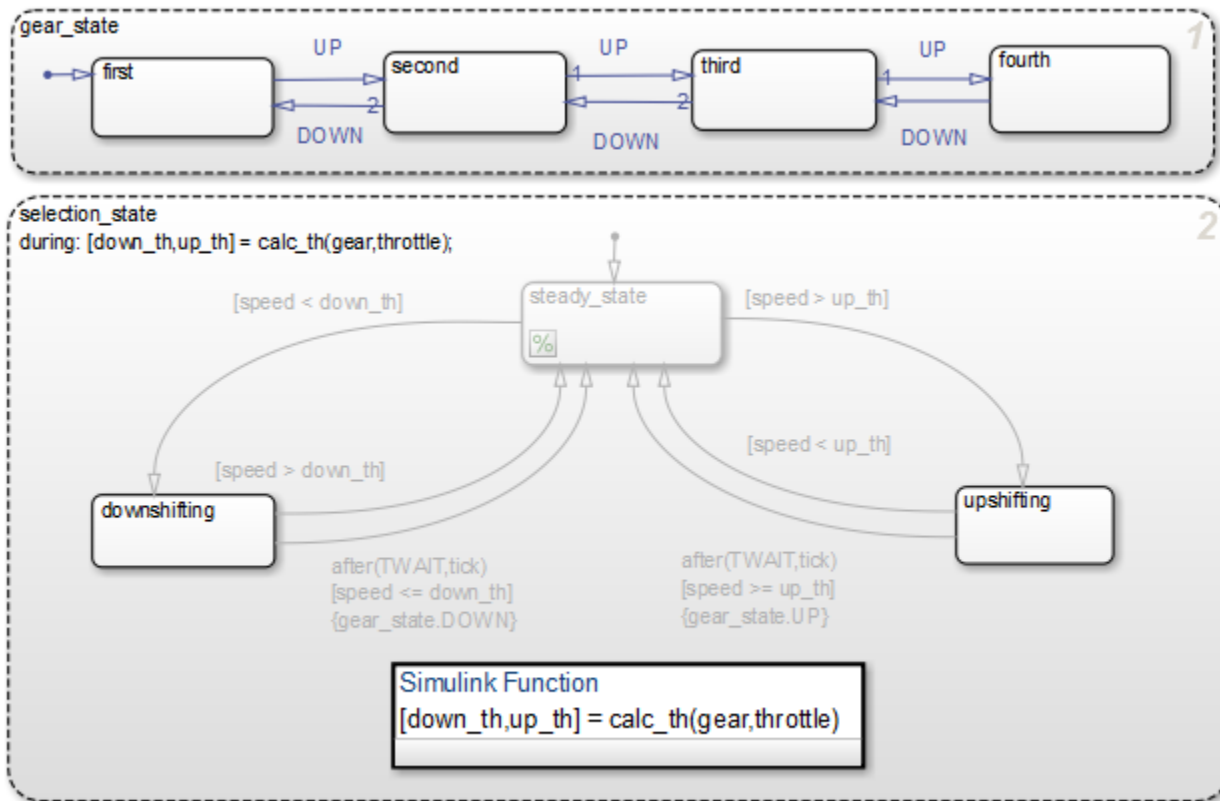

Explicitly Commented Stateflow Object	Implicit Results
States	All incoming and outgoing transitions, and child objects are implicitly commented out.
Transitions	None
Junctions	All connected transitions are implicitly commented out.
Functions	The software cannot invoke a commented function from any chart or model.
Data	You cannot explicitly comment out data. If you comment out the parent object, then the software cannot reference the data.
Events	You cannot explicitly comment out events. If you comment out the parent object, then the software cannot reference the event.

To uncomment an object, right-click the commented object and select **Uncomment**. All implicitly commented objects are restored as well. Implicitly commented objects cannot be uncommented directly.

Add Text to a Commented Object

Add a note to the commented object by clicking the badge . Point to a badge to see the associated comments. You cannot add notes to implicitly commented objects.

Limitations on Commenting Objects

When you comment out an atomic subchart, the objects inside the chart do not appear implicitly commented. However, a commenting badge is displayed in the lower-left corner of the chart.

Explore and Modify Charts

- “Manage Data, Events, and Messages in the Symbols Pane” on page 34-2
- “Use the Model Explorer with Stateflow Objects” on page 34-10
- “Use the Search and Replace Tool” on page 34-14

Manage Data, Events, and Messages in the Symbols Pane

In the Symbols pane, you can view and manage data, events, and messages while working in the Stateflow Editor. In the **Modeling** tab, select **Symbols Pane**.

From the Symbols pane you can:

- Add and delete data, events, and messages.
- Set the object type and scope.
- Change the port number.
- Edit the name of an object and update all instances of the object name in the chart.
- Undo and redo changes in type, name, and port number.
- Detect unused objects.
- Detect and fix unresolved objects.
- Trace between objects in the window and where the objects are used in the chart.
- View and edit object properties in the Property Inspector.

The screenshot shows the Stateflow Editor interface. The main workspace displays a state transition diagram for a Tetris game. The diagram includes states such as `Moving`, `NewShape`, `NextLevel`, `Stopped`, and `FreezeShape`. Transitions are labeled with events like `(initArena();)`, `[!Touching(px,py-1)]`, and `[py >= ARENA_HEIGHT]`. The Symbols pane on the right provides a hierarchical view of the objects and their associated data, events, and messages.

TYPE	NAME	PORT
▶	MainArea	
▶	WaitingArea	
▶	rotateAC	
▶	rotateC	
▶	randInput	1
▶	left	2
▶	right	3
▶	drop	4
▶	rotc	5
▶	rotac	6
▶	down	7
▶	ARENA_HEIGHT	
▶	ARENA_WIDTH	
▶	GAME_OVER	1



The rows in the Symbols pane display object hierarchy. Expand an object in the window to see data, events, and messages parented by that object. By default, all the nongraphical objects in a chart are listed in the window. To view only the objects that are used at the current level of hierarchy and

below, select the  icon. To search for specific symbols, type in the Filter search box .

Add and Modify Data, Events, and Messages

To add a nongraphical object to a Stateflow block, in the Symbols pane:

- 1 Select one of these icons.

Object	Icon
Data	
Event	
Message	

- 2 In the row for the new object, under **TYPE**, choose the object type.
- 3 Edit the name of the object.
- 4 For input and output objects, under **PORT**, choose a port number.
- 5 To view the object in the Property Inspector, right-click the object and select **Inspect**.
- 6 In the Property Inspector, modify the object properties.

After you add objects through the Symbols pane, the objects appear as unused until you reference them in your Stateflow design.

In the Symbols pane, you can modify the name, type, and port number of Stateflow objects. Edit the name of objects in the **NAME** field. When you rename an object, select **Shift+Enter** to rename all instances of the object throughout the state machine. To change the type or port number of an object, click the corresponding field and select from the available options. To delete an object from the state machine, right-click the object and select **Delete**.

Detect Unused Data in the Symbols Pane

The Symbols pane indicates unused data, messages, functions, and events with a yellow warning icon. To delete unused objects, right-click the object in the Symbols pane and select **Delete**. By removing objects that have no effect on simulation, you can reduce the size of your model. In this chart, after you add **data**, it first appears as unused. After you reference **data** in the chart, the warning sign disappears.

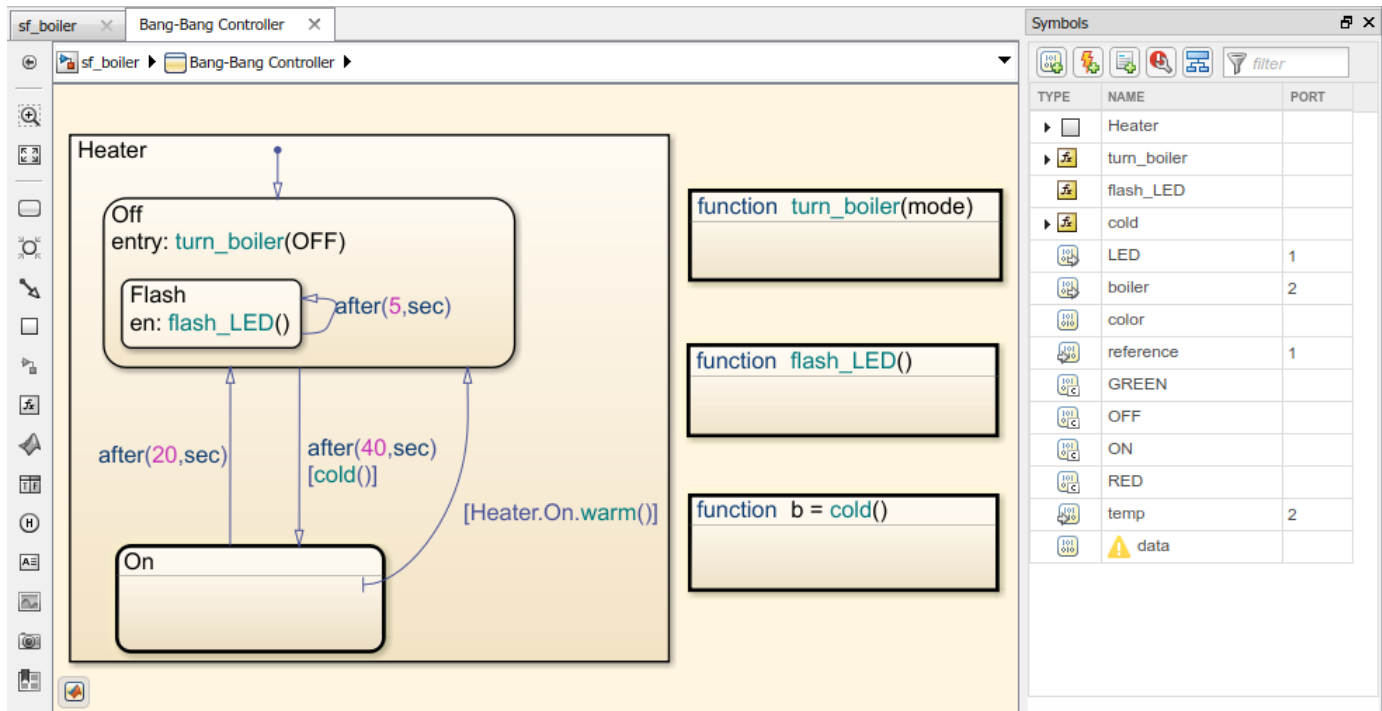

The following types of unused data are not detected:

- Machine-parented data
- Inputs and outputs of MATLAB functions
- Data of parameter scope in a chart that contains atomic subcharts

Trace Data, Events, and Messages

Stateflow provides traceability between the state machine and nongraphical symbols. When you select a symbol in the Symbols pane, Stateflow highlights sections of the chart that access that symbol. When you select an object in your chart, Stateflow highlights the symbols that the object uses.

To control when the objects and symbols are highlighted, select the preference button . A drop-down menu appears.

SYMBOL SELECTION ACTION

Highlight uses on diagram

Highlight all uses

Highlight reads

Highlight writes

EDITOR SELECTION ACTION

Highlight used symbols

VALUE DISPLAY FORMAT

Floats:

Integers:

Fixed Point:

For Stateflow to highlight symbols in the Symbols pane that an object uses, select **Highlight used symbols**. For Stateflow to highlight objects in the chart that use an symbol, select **Highlight uses on diagram**. With **Highlight uses on diagram** you can choose to highlight:

- All uses of the symbol in your chart.
- Objects from where the symbol is read.
- Objects to where the symbol is written.

For example, open the model `sf_tetris2` and double-click the chart `TetrisLogic`. In the Symbols pane, when you select constant `ARENA_HEIGHT`, the states and functions that use `ARENA_HEIGHT` are highlighted. If the chart does not use an object, the symbol appears in the window with a yellow

warning icon .

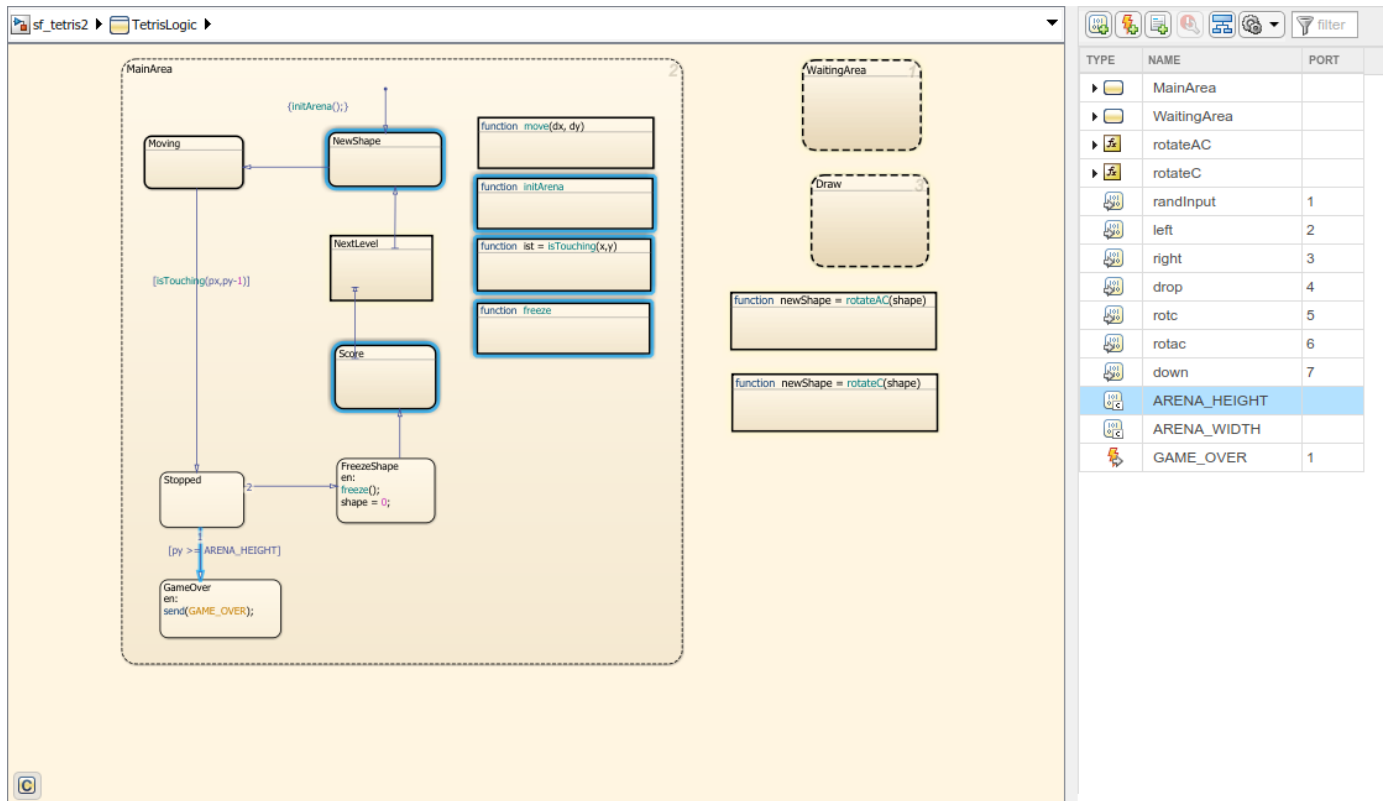

To see the uses of the constant ARENA_HEIGHT, open the function freeze.

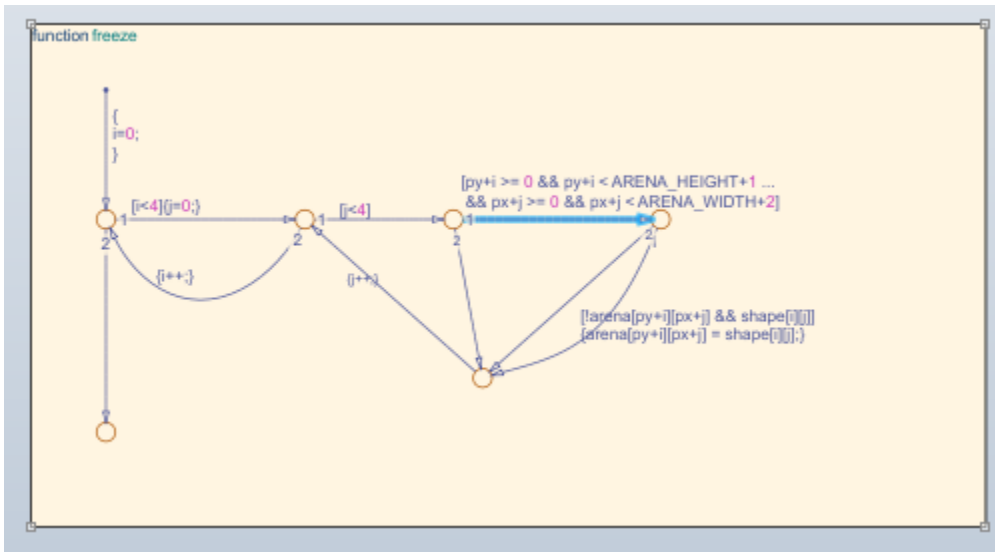

You can also select a graphical object such as a state, transition, or function in the chart and view the symbols that the object uses. For example, in the chart TetrLogic, expand the symbol MainArea in the Symbols pane. If you select the state FreezeShape in the chart, then the local data shape and the function freeze() are highlighted in the Symbols pane. This highlighting indicates that those objects are used inside the state FreezeShape.

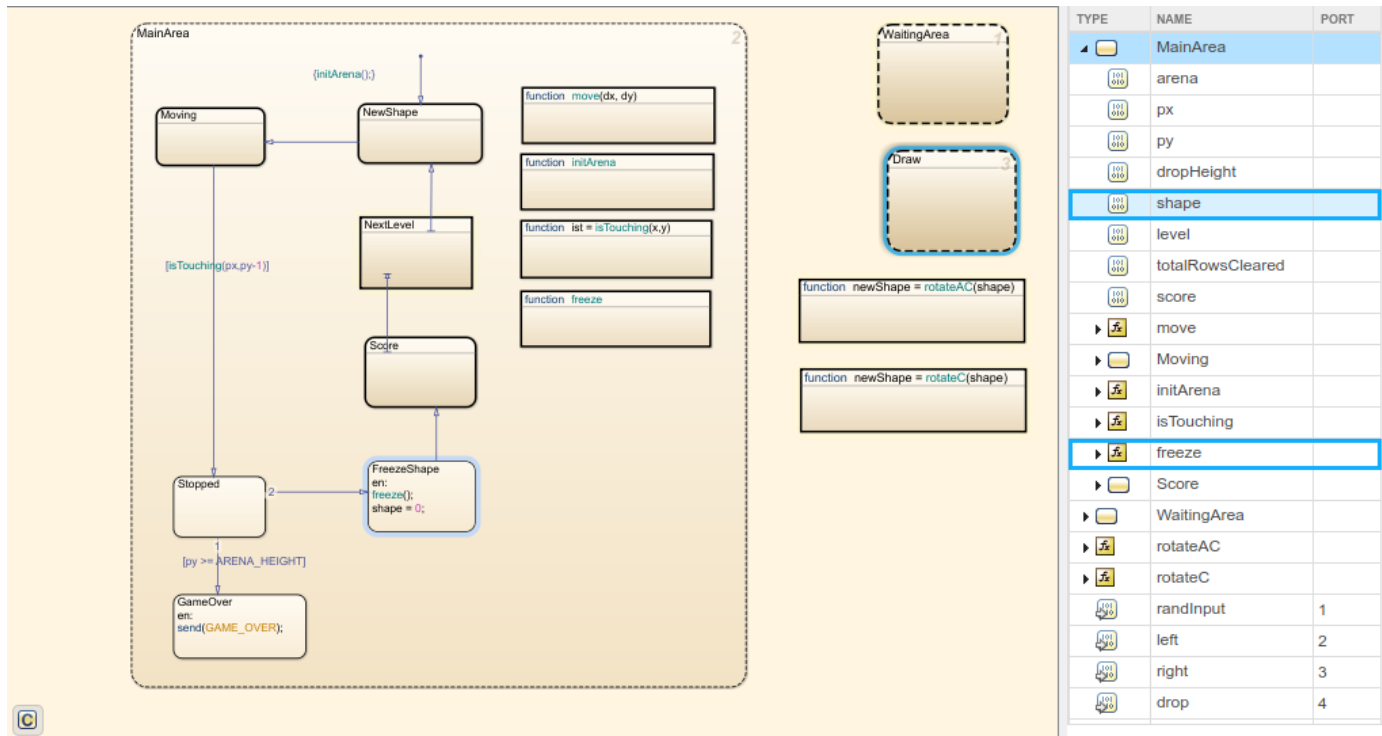

When in debugging mode, the values of each data are displayed in the **VALUE** column of the Symbols pane. Stateflow updates the values periodically when the simulation is running. The value column highlights changes to data values as the changes occur. When the debugger is stopped at a breakpoint, you can update the initial value or change the value of a symbols in either the command prompt or the Symbols pane.

Data or Message	Update Initial Value	Update During Debugging
Input	No	No
Output	Yes	Yes
Parameter	No	No
Constant	Yes	No
Data Store Memory	No	Yes
Local	Yes	Yes

For bus elements, you can change the value of a symbols in either the command prompt or the Symbols pane.

Bus Element	Update Initial Value	Update During Debugging
Input	No	No
Output	No	Yes
Parameter	No	No
Constant	No	No
Data Store Memory	No	Yes

Bus Element	Update Initial Value	Update During Debugging
Local	No	Yes

In the Symbols pane multidimensional arrays appear as the data type and size of the array. If the array does not exceed more than 100 elements, hover over the symbol to view the elements. For arrays that contain more than 100 elements, view the elements by using the command prompt.

When simulation is paused, hover over messages in the canvas to view payloads in the queue. This is similar to the hover functionality on the canvas. For other non-scalar objects, the size and data type appear. To see these values, use the Watch window. See “Inspect and Modify Data and Messages While Debugging” on page 33-9 and “Track Data in the Watch List” on page 33-11.

The screenshot shows a simulation environment with a state machine diagram on the left and a Symbols pane on the right. The state machine diagram includes states like Moving, NewShape, NextLevel, Score, Stopped, FreezeShape, and GameOver, with transitions and associated functions. The Symbols pane table is as follows:

TYPE	NAME	VALUE	PORT
int	randInput	6.9825	1
int	left	0	2
int	right	0	3
int	drop	0	4
int	rotc	0	5
int	rotac	0	6
int	down	0	7
int	ARENA_HEIGHT	20	
int	ARENA_WIDTH	10	
bool	GAME_OVER		1
object	MainArea		
uint8	arena	21x12 uint8	
uint8	px	6	
uint8	py	0	
uint8	dropHeight	0	
uint8	shape	4x4 uint8	
uint8	level	1	
uint8	totalRowsCleare	0	
uint8	score	0	
object	move		
object	Moving		
object	initArena		

Symbols Pane Limitations

You cannot add the types of objects listed in the table via the Symbols pane. To add these types of objects, use the Model Explorer. As a best practice, avoid using machine-parented data.

Object	Via Symbols Pane	Visible in Symbols Pane
Data, events, and messages parented by a state	No	Yes
Data, events, and messages inside a function	No	Yes
Data and events parented by the state machine	No	No

Additional limitations:

- When you modify the code in a MATLAB function, the changes are not updated in the Symbols pane until after you save the MATLAB function.
- You cannot undo or redo changes to input and output for MATLAB functions.
- You cannot recover deleted data, events, or messages from a state transition table.
- You cannot undo scope changes to data parented by graphical functions, MATLAB functions, and truth tables.
- You cannot undo renaming an object for truth tables.
- When you delete data for objects contained in a Simulink based state, the object remains in your Simulink based state and the data symbol is shown as undefined in the Symbols pane.

See Also

More About

- “Resolve Undefined Symbols in Your Chart” on page 31-24
- “Add Stateflow Data” on page 9-2
- “Set Data Properties” on page 9-5

Use the Model Explorer with Stateflow Objects

In this section...

- “View Stateflow Objects in the Model Explorer” on page 34-10
- “Edit Chart Objects in the Model Explorer” on page 34-11
- “Add Data and Events in the Model Explorer” on page 34-11
- “Rename Objects in the Model Explorer” on page 34-11
- “Set Properties for Chart Objects in the Model Explorer” on page 34-11
- “Move and Copy Data and Events in the Model Explorer” on page 34-12
- “Change the Port Order of Input and Output Data and Events” on page 34-13
- “Delete Data and Events in the Model Explorer” on page 34-13

View Stateflow Objects in the Model Explorer

You can use one of these methods for opening the Model Explorer:

- In the **Modeling** tab, select **Model Explorer**.
- Right-click an empty area in the chart and select **Explore**.

The Model Explorer appears something like this:

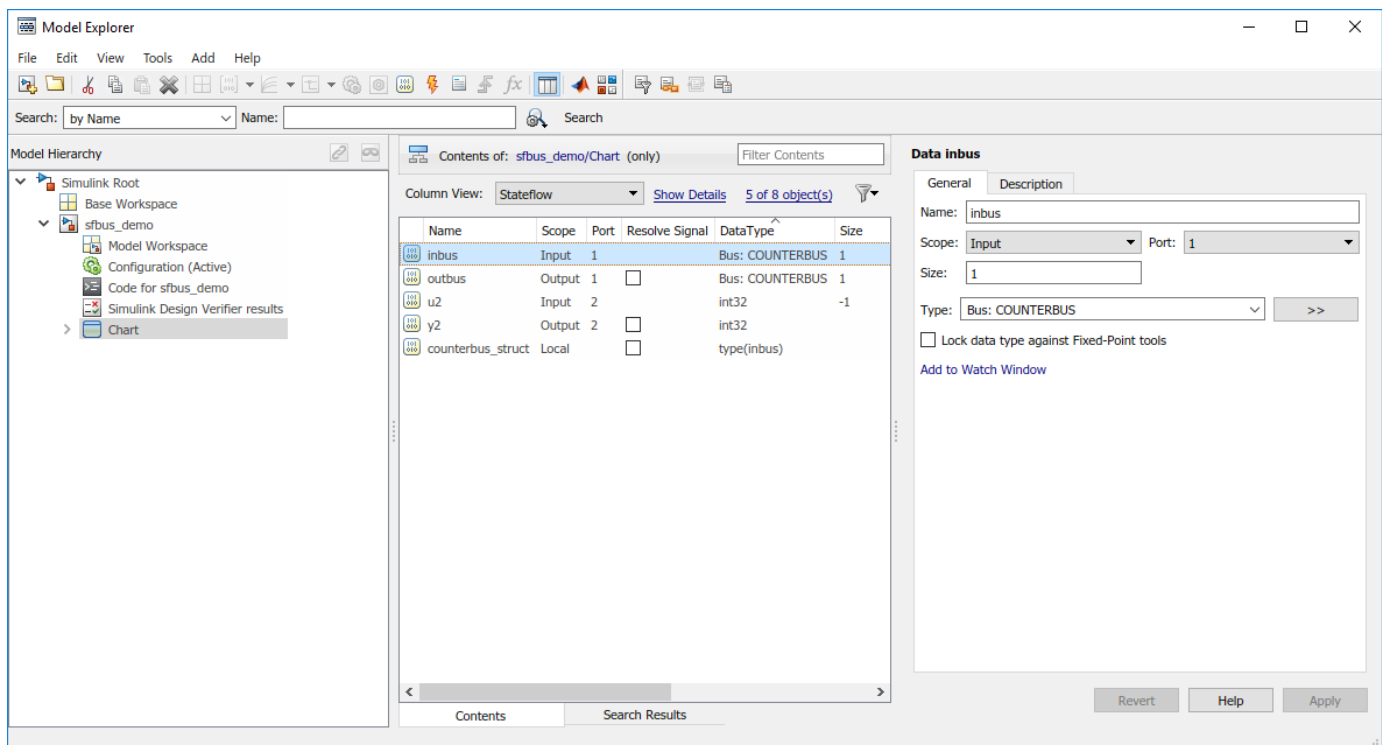

The main window has two panes: a **Model Hierarchy** pane on the left and a **Contents** pane on the right. When you open the Model Explorer, the Stateflow object you are editing appears highlighted in the **Model Hierarchy** pane and its objects appear in the **Contents** pane. This example shows how the Model Explorer appears when opened from the chart.

The **Model Hierarchy** pane displays the elements of all loaded Simulink models, which includes Stateflow charts. A preceding plus (+) character for an object indicates that you can expand the display of its child objects by double-clicking the entry or by clicking the plus (+). A preceding minus (-) character for an object indicates that it has no child objects.

Clicking an entry in the **Model Hierarchy** pane selects that entry and displays its child objects in the **Contents** pane. A hypertext link to the currently selected object in the **Model Hierarchy** pane appears after the **Contents of:** label at the top of the **Contents** pane. Click this link to display that object in its native editor. In the preceding example, clicking the link `sfbus_demo/Chart` displays the contents of the chart in its editor.

Each type of object, whether in the **Model Hierarchy** or **Contents** pane, appears with an adjacent icon. Subcharted objects (states, boxes, or graphical functions) appear altered with shading.

The display of child objects in the **Contents** pane includes properties for each object, most of which are directly editable. You can also access the properties dialog box for an object from the Model Explorer. See “Set Properties for Chart Objects in the Model Explorer” on page 34-11 for more details.

Edit Chart Objects in the Model Explorer

To edit a chart object that appears in the **Model Hierarchy** pane of the Model Explorer:

- 1 Right-click the object.
- 2 Select **Open** from the context menu.

The selected object appears highlighted in the chart.

Add Data and Events in the Model Explorer

To add data or events using the Model Explorer, see the following links:

- “Add Data Through the Model Explorer” on page 9-3
- “Add Events Through the Model Explorer” on page 11-3

Rename Objects in the Model Explorer

To rename a chart object in the Model Explorer:

- 1 Right-click the object row in the **Contents** pane of the Model Explorer and select **Rename**.

The name of the selected object appears in a text edit box.

- 2 Change the name of the object and click outside the edit box.

Set Properties for Chart Objects in the Model Explorer

To change the property of an object in the **Contents** pane of the Model Explorer:

- 1 In the **Contents** pane, click in the row of the displayed object.
- 2 Click an individual entry for a property column in the highlighted row.

- For text properties, such as the Name property, a text editing field with the current text value overlays the displayed value. Edit the field and press the **Enter** key or click anywhere outside the edit field to apply the changes.
- For properties with enumerated entries, such as the Scope, Trigger, or Type properties, select from a drop-down combo box that overlays the displayed value.
- For Boolean properties (properties that are set on or off), select or clear the box that appears in place of the displayed value.

To set all the properties for an object displayed in the **Model Hierarchy** or **Contents** pane of the Model Explorer:

- 1 Right-click the object and select **Properties**.

The properties dialog box for the object appears.

- 2 Edit the appropriate properties and click **Apply** or **OK**.

To display the properties dialog box dynamically for the selected object in the **Model Hierarchy** or **Contents** pane of the Model Explorer:

- 1 Select **View > Show Dialog Pane**.

The properties dialog box for the selected object appears in the far right pane of the Model Explorer.

Move and Copy Data and Events in the Model Explorer

Note If you move an object to a level in the hierarchy that does not support the **Scope** property for that object, the **Scope** automatically changes to **Local**.

To move data and event objects to another parent:

- 1 Select the data or event to move in the **Contents** pane of the Model Explorer.

You can select a contiguous block of items by highlighting the first (or last) item in the block and then using **Shift** + click for highlighting the last (or first) item.

- 2 Click and drag the highlighted objects from the **Contents** pane to a new location in the **Model Hierarchy** pane to change its parent.

A shadow copy of the selected objects accompanies the mouse cursor during dragging. If no parent is chosen or the parent chosen is the current parent, the mouse cursor changes to an X enclosed in a circle, indicating an invalid choice.

To cut or copy the selected data or event:

- 1 Select the event or data to cut or copy in the **Contents** pane of the Model Explorer.
- 2 In the Model Explorer, select **Edit > Cut** or **Edit > Copy**.

If you select **Cut**, the selected items are deleted and then copied to the clipboard for copying elsewhere. If you select **Copy**, the selected items are left unchanged.

You can also right-click a single selection and select **Cut** or **Copy** from the context menu. The Model Explorer also uses the keyboard equivalents of **Ctrl+X** (Cut) and **Ctrl+C** (Copy) on a computer running the UNIX or Windows operating system.

- 3 Select a new parent object in the **Model Hierarchy** pane of the Model Explorer.
- 4 Select **Edit > Paste**. The cut items appear in the **Contents** pane of the Model Explorer.

You can also paste the cut items by right-clicking an empty part of the **Contents** pane and selecting **Paste** from the context menu. The Model Explorer also uses the keyboard equivalent of **Ctrl+V** (Paste) on a computer running the UNIX or Windows operating system.

Change the Port Order of Input and Output Data and Events

Input data, output data, input events, and output events each have numerical sequences of port index numbers. You can change the order of indexing for event or data objects with a scope of **Input** or **Output** in the **Contents** pane of the Model Explorer as follows:

- 1 Select one of the input or output data or event objects.
- 2 Click the **Port** property for the object.
- 3 Enter a new value for the Port property for the object.

The remaining objects in the affected sequence are automatically assigned a new value for their **Port** property.

Delete Data and Events in the Model Explorer

Delete data and event objects in the **Contents** pane of the Model Explorer as follows:

- 1 Select the object.
- 2 Press the **Delete** key.

You can also select **Edit > Cut** or **Ctrl+X** from the keyboard to delete an object.

Use the Search and Replace Tool

Open the Search & Replace Tool

To open the Search & Replace dialog box:

- 1 Open a chart.
- 2 In the **Modeling** tab, select **Find > Find & Replace in Chart**.

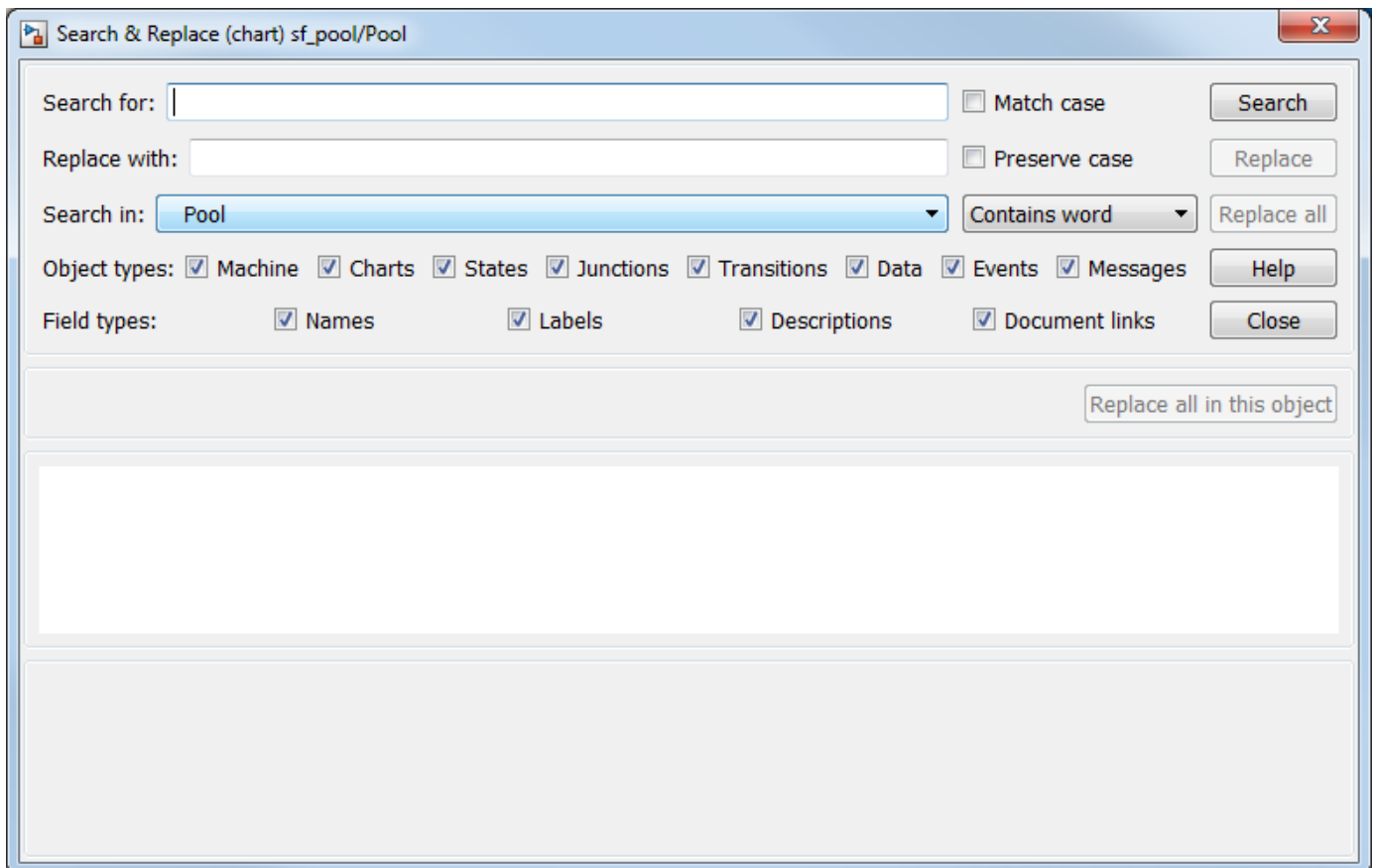

The Search & Replace dialog box contains the following fields:

- **Search for**

Enter search pattern text in the **Search for** text box. You can select the interpretation of the search pattern with the **Match case** check box and the **Match options** field (unlabeled and just to the right of the **Search in** field).

- **Match case**

If you select this check box, the search is case sensitive and the Search & Replace tool finds only text matching the search pattern exactly.

- **Replace with**

Specify the text to replace the text found when you select any of the **Replace** buttons (**Replace**, **Replace all**, **Replace all in this object**). See “Use Replace Buttons” on page 34-20.

- **Preserve case**

This option modifies replacement text. For an understanding of this option, see “Replacing with Case Preservation” on page 34-20.

- **Search in**

By default, the Search & Replace tool searches for and replaces text only within the current Stateflow chart that you are editing in the Stateflow Editor. You can select to search the machine owning the current Stateflow chart or any other loaded machine or chart by accessing this selection box.

- **Match options**

This field is unlabeled and just to the right of the **Search in** field. You can modify the meaning of your search text by entering one of the selectable search options. See “Refine Searches” on page 34-15.

- **Object types** and **Field types**

Under the **Search in** field are the selection boxes for **Object types** and **Field types**. These selections further refine your search and are described below.

- **Search** and **Replace** buttons

These are described in “Use the Search Button and View Area” on page 34-17 and “Use Replace Buttons” on page 34-20.

- **View Area**

The bottom half of the Search & Replace dialog box displays the result of a search. This area is described in “A Breakdown of the View Area” on page 34-19.

Refine Searches

Enter search pattern text in the **Search for** text box. You can use one of the following settings to further refine the meaning of the text entered.

Match case

By selecting the **Match case** option, you enable case-sensitive searching. In this case, the Search & Replace tool finds only text matching the search pattern exactly.

By clearing the **Match case** option, you enable case-insensitive searching. In this case, search pattern characters entered in lower- or uppercase find matching text with the same sequence of base characters in lower- or uppercase. For example, the search entry "AnDrEw" finds the matching text "andrew" or "Andrew" or "ANDREW".

Preserve case

This option modifies replacement text and not search text. For details, see “Replacing with Case Preservation” on page 34-20.

Contains word

Select this option to specify that the search pattern text is a whole word expression used in a Stateflow chart with no specific beginning and end delimiters. In other words, find the specified text in any setting.

Suppose that you have a state with this label and entry action:

```
throt_fail
entry: fail_state[THROT] = 1;
```

Searching for the text `fail` with the **Contains word** option finds two occurrences of `fail`.

Match whole word

Select this option to specify that the search pattern in the **Search for** field is a whole word expression used in a Stateflow chart with beginning and end delimiters consisting of a blank space or a character that is not alphanumeric and not an underscore character (`_`).

In the previous example of a state named `throt_fail`, if **Match whole word** is selected, searching for `fail` finds no text within that state. However, searching for `"fail_state"` does find the text `"fail_state"` as part of the second line since it is delimited by a space at the beginning and a left square bracket (`[`) at the end.

Regular expression

Set the **Match options** field to **Regular expression** to search for text that varies from character to character within defined limits.

A regular expression is text composed of letters, numbers, and special symbols that defines one or more candidates. Some characters have special meaning when used in a regular expression, while other characters are interpreted as themselves. Any other character appearing in a regular expression is ordinary, unless a back slash (`\`) character precedes it.

If the **Match options** field is set to **Regular expression** in the previous example of a state named `throt_fail`, searching for `"fail_"` matches the `"fail_"` text that is part of the second line, character for character. Searching with the regular expression `"\w*_"` also finds the text `"fail_"`. This search uses the regular expression shorthand `"\w"` that represents any part-of-word character, an asterisk (`*`) that represents any number of any characters, and an underscore (`_`) that represents itself.

For a list of regular expression meta characters, see “Regular Expressions” (MATLAB).

Specify the Search Scope

You specify the scope of your search by selecting from the field regions discussed in the topics that follow.

Search in

You can select a whole machine or individual chart for searching in the **Search in** field. By default, the current chart in which you opened the Search & Replace tool is selected.

To select a machine, follow these steps:

- 1 Select the down arrow of the **Search in** field.

A list of the currently loaded machines appears with the current machine expanded to reveal its Stateflow charts.

- 2 Select a machine.

To select a Stateflow chart for searching, follow these steps:

- 1 Select the down arrow of the **Search in** field again.

This list contains the previously selected machine expanded to reveal its Stateflow charts.

- 2 Select a chart from the expanded machine.

Object Types

Limit your search by deselecting one or more object types.

Note You cannot search in state transition tables with this tool.

Field Types

Limit your search by deselecting one or more field types.

Available field types are as follows.

Names

Machines, charts, data, and events have valid **Name** fields. States have a **Name** defined as the top line of their labels. You can search and replace text belonging to the **Name** field of a state in this sense. However, if the Search & Replace tool finds matching text in a state's **Name** field, the rest of the label is subject to later searches for the specified text whether or not the label is chosen as a search target.

Note The **Name** field of machines and charts is an invalid target for the Search & Replace tool. Use the Simulink model window to change the names of machines and charts.

Labels

Only states and transitions have labels.

Descriptions

All objects have searchable **Description** fields.

Document links

All objects have searchable **Link** fields.

Use the Search Button and View Area

This topic contains the following subtopics:

- “A Breakdown of the View Area” on page 34-19
- “The Search Order” on page 34-19

Click **Search** to initiate a single-search operation. If an object match is made, its text fields appear in the **Viewer** pane in the middle of the Search & Replace dialog box. If the object is graphical (state, transition, junction, chart), the matching object appears highlighted in a **Portal** pane below the **Viewer** pane.

Search & Replace (chart) sf_pool/Pool

Search for: friction Match case Search

Replace with: Preserve case Replace

Search in: Pool Contains word Replace all

Object types: Machine Charts States Junctions Transitions Data Events Messages Help

Field types: Names Labels Descriptions Document links Close

(state) sf_pool/Pool.TotalDynamics Replace all in this object

Label: TotalDynamics

```
du:
// derivatives
p_dot = v;
v_dot = frictionForce() + interactionForce();
```

Portal:

MATLAB Function initBalls

/initBalls();

TotalDynamics

```
du:
// derivatives
p_dot = v;
v_dot = frictionForce() + interactionForce();

// chart outputs
p_out = p;
v_out = v;
pocketed_out = pocketed;
```

1 [isAnyBallGoingToStop() /updateStopFlags();]

2 [hasBallInteractionChan! /ball_interaction = getBa updateStopFlags();]

3 [isAnyBallNewlyPockete /pocketNewBalls(); updateStopFlags();]

4 [isAnyBallOutOfBounds /resetBallsPosAndVel(); updateStopFlags();]

MATLAB Function f = interactionForce

A Breakdown of the View Area

The view area of the Search & Replace dialog box displays matching text and its containing object, if viewable. In the previous example, taken from the `sf_pool` model, a search for the word "friction" finds the **Description** field for the state `TotalDynamics`. The resulting view area consists of these parts:

Icon

Displays an icon appropriate to the object containing the matching text. These icons are identical to the icons in the Model Explorer that represent Stateflow objects displayed in "View Stateflow Objects in the Model Explorer" on page 34-10.

Full Path Name of Containing Object

This area displays the full path name for the object that contains the matching text:

```
(<type>) <machine name>/<subsystem>/<chart
name>.[p1]. . . [pn].<object name> (<id>)
```

where p_1 through p_n denote the object's parent states.

Viewer

This area displays the matching text as a highlighted part of all search-qualified text fields for the owner object. If other occurrences exist in these fields, they too are highlighted, but in lighter shades.

To invoke the properties dialog box for the owner object, double-click anywhere in the Viewer pane.

Portal

This area contains a graphic display of the object that contains the matching text. That object appears highlighted.

To display the highlighted object in the Stateflow Editor, double-click anywhere in the Portal pane.

The Search Order

If you specify an entire machine as your search scope in the **Search in** field, the Search & Replace tool starts searching at the beginning of the first chart of the model, regardless of the Stateflow chart that appears in the Stateflow Editor when you begin your search. After searching the first chart, the Search & Replace tool continues searching each chart in model order until all charts for the model have been searched.

If you specify a Stateflow chart as your search scope, the Search & Replace tool begins searching at the beginning of the chart. The Search & Replace tool continues searching the chart until all the chart objects have been searched.

The search order when searching an individual chart for matching text is equivalent to a depth-first search of the Model Explorer. Starting at the highest level of the chart, the Model Explorer hierarchy is traversed downward from parent to child until an object with no child is encountered. At this point, the hierarchy is traversed upward through objects already searched until an unsearched sibling is found and the process repeats.

Specify the Replacement Text

The Search & Replace tool replaces matching text with the exact (case-sensitive) text you entered in the **Replace With** field unless you selected the **Preserve case** option.

Replacing with Case Preservation

If you choose the **Preserve case** option, matching text is replaced based on one of these conditions:

- Whisper

Matching text has only lowercase characters. Matching text is replaced entirely with the lowercase equivalent of all replacement characters. For example, if the replacement text is "ANDREW", the matching text "bill" is replaced by "andrew".

- Shout

Matching text has only uppercase characters. Matching text is replaced entirely with the uppercase equivalent of all replacement characters. For example, if the replacement text is "Andrew", the matching text "BILL" is replaced by "ANDREW".

- Proper

Matching text has uppercase characters in the first character position of each word. Matching text is replaced entirely with the case equivalent of all replacement characters. For example, if the replacement text is "andrew johnson", the matching text "Bill Monroe" is replaced by "Andrew Johnson".

- Sentence

Matching text has an uppercase character in the first character position of a sentence with all other sentence characters in lowercase. Matching text is replaced in like manner, with the first character of the sentence given an uppercase equivalent and all other sentence characters set to lowercase. For example, if the replacement text is "andrew is tall.", the matching text "Bill is tall." is replaced by "Andrew is tall."

If the matching text does not follow any of these patterns, then the text and case replacement match the user input.

Use Replace Buttons

You can activate the replace buttons (**Replace**, **Replace all**, **Replace all in this object**) only after a search that finds text.

Replace

When you select the **Replace** button, the current instance of text matching the text in the **Search for** field is replaced by the text you entered in the **Replace with** field. The Search & Replace tool then searches for the next occurrence of the **Search for** text.

Replace all

When you select the **Replace all** button, all instances of text matching the **Search for** field are replaced by the text entered in the **Replace with** field. Replacement starts at the point of invocation to the end of the current Stateflow chart. If you initially skip through some search matches with the **Search** button, these matches are also skipped when you select the **Replace all** button.

Replace all in this object

When you select the **Replace all in this object** button, all instances of text matching the **Search for** field are replaced by text you entered in the **Replace with** field everywhere in the current Stateflow object regardless of previous searches.

Search and Replace Messages

Informational and warning messages appear in the **Full Path Name Containing Object** field along with a defining icon.



- Informational Messages



- Warnings

The following messages are informational:

Please specify a search string

A search was attempted without search text specified.

No Matches Found

No matches exist in the selected search scope.

Search Completed

No more matches exist in the selected search scope.

The following warnings refer to invalid conditions for searching or replacing:

Invalid option set

The object types and field types that you selected are incompatible.

Match object not currently editable

The matching object is not editable by replacement due to one of these problems.

Problem	Solution
A simulation is running.	Stop the simulation.
You are editing a locked library block.	Unlock the library.
The current object or its parent has been manually locked.	Unlock the object or its parent.

The following warnings appear if the Search & Replace tool must find the object again and its matching text field. If the original matching object is deleted or changed before an ensuing search or replacement, the Search & Replace tool cannot continue.

Search object not found

If you search for text, find it, and then delete the containing object, this warning appears if you continue to search.

Match object not found

If you search for text, find it, and then delete the containing object, this warning appears if you perform a replacement.

Match not found

If you search for text, find it, and then change the object containing the text, this warning appears if you perform a replacement.

Search string changed

If you search for text, find it, and then change the **Search for** field, this warning appears if you perform a replacement.

Standalone Stateflow Charts for Execution in MATLAB

- “Create Stateflow Charts for Execution as MATLAB Objects” on page 35-2
- “Execute and Unit Test Stateflow Chart Objects” on page 35-8
- “Debug a Standalone Stateflow Chart” on page 35-13
- “Execute Stateflow Chart Objects Through Scripts and Models” on page 35-18
- “Design Human-Machine Interface Logic by Using Stateflow Charts” on page 35-24
- “Model a Communications Protocol by Using Chart Objects” on page 35-28
- “Implement a Financial Strategy by Using Stateflow” on page 35-32
- “Automate Control of Intelligent Vehicles by Using Stateflow Charts” on page 35-35
- “Create an App for Analog Triggered Data Acquisition by Using Stateflow Charts” on page 35-39

Create Stateflow Charts for Execution as MATLAB Objects

To combine the advantages of state machine programming with the full functionality of MATLAB, create a standalone Stateflow chart outside of a Simulink model. Save the standalone chart with the extension `.sfx` and execute it as a MATLAB object. Refine your design by using chart animation and graphical debugging tools.

With standalone charts, you can create MATLAB applications such as:

- MATLAB App Designer user interfaces that use mode logic to manage the behavior of widgets. See “Design Human-Machine Interface Logic by Using Stateflow Charts” on page 35-24.
- Communication protocols and data stream processing applications that use sequential logic. See “Model a Communications Protocol by Using Chart Objects” on page 35-28.
- Data Acquisition Toolbox™ or Instrument Control Toolbox™ applications that use timer-based logic to monitor and control external tasks. See “Implement a Financial Strategy by Using Stateflow” on page 35-32.

These applications can be shared and executed without requiring a Stateflow license. For more information, see “Share Standalone Charts” on page 35-3.

Construct a Standalone Chart

To construct a standalone Stateflow chart, open the Stateflow Editor by using the `edit` function. For example, at the MATLAB Command Window, enter:

```
edit chart.sfx
```

If the file `chart.sfx` does not exist, the Stateflow Editor opens an empty chart with the name `chart`. Otherwise, the editor opens the chart defined by the `sfx` file.

After you save a standalone chart, the `help` function displays information about executing it in MATLAB:

```
help chart.sfx
```

Create a Stateflow Chart Object

To execute a standalone chart in MATLAB, first create a Stateflow chart object. Use the name of the `sfx` file for the standalone chart as a function. Specify the initial values of data as name-value pairs. For example, this command creates the chart object `chartObject`, initializes `data1` and `data2`, and executes its default transition:

```
chartObject = chart('data1',value1,'data2',value2)
```

To display chart information, such as the syntax for execution, the values of the chart data, and the list of active states, use the `disp` function:

```
disp(chartObject)
```

Execute a Standalone Chart

After you define a Stateflow chart object, you can execute the standalone chart by calling the `step` function (with data values, if necessary):

```
step(chartObject, 'data1', value1, 'data2', value2)
```

Alternatively, you can call one of the input event functions:

```
event_name(chartObject, 'data1', value1, 'data2', value2)
```

In either case, the values are assigned to local data before the chart executes.

If your chart has graphical or MATLAB functions, you can call them directly in the MATLAB Command Window. Calling a chart function does not execute the standalone chart.

```
function_name(chartObject, u1, u2)
```

Note If you use `nargin` in a graphical or MATLAB function in your chart, `nargin` counts the chart object as one of the input arguments. The value of `nargin` is the same whether you call the function from the chart or from the MATLAB Command Window.

You can execute a standalone chart without opening the Stateflow Editor. If the chart is open, then the Stateflow Editor highlights active states and transitions through chart animation.

For the purposes of debugging and unit testing, you can execute a standalone chart directly from the Stateflow Editor. During execution, you enter data values and broadcast events from the user interface. For more information, see “Execute and Unit Test Stateflow Chart Objects” on page 35-8.

You can execute a standalone chart from a MATLAB script, a Simulink model, or an App Designer user interface. For more information, see:

- “Execute Stateflow Chart Objects Through Scripts and Models” on page 35-18
- “Design Human-Machine Interface Logic by Using Stateflow Charts” on page 35-24

Stop Chart Execution

To stop executing a chart, destroy the chart object by calling the `delete` function:

```
delete(chartObject)
```

After the chart object is deleted, any handles to the chart object remain in the workspace, but become invalid. To remove the invalid handle from the workspace, use the command `clear`:

```
clear chartObject
```

If you clear a valid chart object handle and there are other handles to the same chart object, the chart object is not destroyed. For example, when you are executing a chart, the Stateflow Editor contains internal handles to the chart object. Clearing the chart object handle from the workspace does not destroy the chart object or remove the chart animation highlighting in the editor. To reset the animation highlighting, right-click the chart canvas and select **Remove Highlighting**.

Share Standalone Charts

You can share standalone charts with collaborators who do not have a Stateflow license.

If your collaborators have the same version of MATLAB that you have, they can execute your standalone charts as MATLAB objects without opening the Stateflow Editor. Chart animation and

debugging are not supported. Run-time error messages do not link to the state or transition in the chart where the error occurs.

If your collaborators have an earlier version of MATLAB, export a standalone chart to a format that they can use. You can only export to R2019a and later releases. To complete the export process, you need access to the versions of Stateflow from which and to which you are exporting.

- 1 Using the later version of Stateflow, open the standalone chart.
- 2 On the **State Chart** tab, select **Save > Previous Version**.
- 3 In the Export to Previous Version dialog box, specify a file name for the exported chart.
- 4 From the **Save as type** list, select the earlier version to which to export the chart.
- 5 Click **Save**.
- 6 Using the earlier version of Stateflow, open and resave the exported chart.

To export a chart from the MATLAB Command Window, call the Stateflow function `exportToVersion`. For more information, see “Export Chart to an Earlier Version of MATLAB”.

Note Attempting to execute an exported chart before resaving it will result in an error.

Properties and Functions of Stateflow Chart Objects

A Stateflow chart object encapsulates data and operations in a single structure by providing:

- Private properties that contain the internal state variables for the standalone chart.
- A `step` function that calls the various operations implementing the chart semantics.

A chart object can have other properties and functions that correspond to the various elements present in the chart.

Standalone Chart Elements	Chart Object Elements
Local and constant data	Public properties
Input events	Functions that execute the chart
Graphical and MATLAB functions	Functions that you can call from the MATLAB Command Window

Chart Object Configuration Options

When you create a chart object, you can specify chart behavior by including these configuration options as name-value pairs.

Configuration Option	Description	Example
<code>-animationDelay</code>	Specify the delay that the chart animation uses to highlight each transition segment. The default value is 0.01 seconds. To produce a chart with no animation delays, set to zero.	Create a chart object that has slow animation by specifying one-second delays. <code>chartObject = chart('animationDelay',1)</code>

Configuration Option	Description	Example
-enableAnimation	Enable chart animation and debugging instrumentation. The default value is true.	Create a chart object that has animation and debugging instrumentation disabled. <code>chartObject = chart('-enableAnimation',false)</code>
-eventQueueSize	Specify the size of the queue used for events and temporal logic operations. The default value is 20. To disable the queuing of events, set to zero. For more information, see “Events in Standalone Charts” on page 3-53.	Create a chart object that ignores all events without warning if they occur when the chart is processing another operation. <code>chartObject = chart('-eventQueueSize',0)</code>
-executeInitStep	Enable the initial execution of default transitions. The default value is true.	Create a chart object but do not execute the default transition. <code>chartObject = chart('-executeInitStep',false)</code>
-warningOnUninitializedData	Enable the warning about empty chart data after initializing the chart object. The default value is true.	Eliminate the warning when creating a chart object. <code>chartObject = chart('-warningOnUninitializedData',false)</code>

Initialization of Chart Data

In the Stateflow Editor, you can use the Symbols pane to specify initial values for chart data. When you create a chart object, chart data is initialized in alphabetical order according to its scope. Constant data is initialized first. Local data is initialized last.

If you use an expression to specify an initial value, then the chart attempts to resolve the expression by:

- Using the values of other data in the chart.
- Calling functions on the search path.

For example, suppose that you specify an initial value for the local data *x* by using the expression *y*. Then:

- If the chart has a constant called *y*, *y* is initialized before *x*. The local data *x* is assigned the same initial value as *y*.
- If the chart has a local data called *y*, *x* is initialized before *y*. The local data *x* is assigned to an empty array. If the configuration option `-warningOnUninitializedData` is set to `true`, a warning occurs.
- If the chart has no data named *y*, *x* is initialized by calling the function *y*. If the file *y.m* is not on the search path, this error occurs:

```
Undefined function or variable 'y'.
```

Stateflow does not search the MATLAB workspace to resolve initial values, so this error occurs even if there is a variable called *y* in the MATLAB workspace.

Capabilities and Limitations

Supported Features

- Classic chart semantics with MATLAB as the action language. You can use the full functionality of MATLAB, including those functions that are restricted for code generation in Simulink. See “Execute Stateflow Chart Objects Through Scripts and Models” on page 35-18.

Note In standalone Stateflow charts, the operating system command symbol ! is not supported. To execute operating system commands, use the function `system`.

- Exclusive (OR) and Parallel (AND) state decomposition with hierarchy. See “State Decomposition” on page 2-16 and “State Hierarchy” on page 2-14.
- Flow charts, graphical functions, and MATLAB functions. See “Reusable Components in Charts”.
- Conversion of MATLAB code to graphical functions by using the Pattern Wizard. See “Convert MATLAB Code into Stateflow Flow Charts” on page 5-18.
- Chart local and constant data without restriction to type. See “Execute and Unit Test Stateflow Chart Objects” on page 35-8.
- Input events. See “Design Human-Machine Interface Logic by Using Stateflow Charts” on page 35-24.
- Operators `hasChanged`, `hasChangedFrom`, and `hasChangedTo` that detect changes in the values of local data.

Note Standalone Stateflow charts do not support change detection on an element of a matrix or a field in a structure.

- Temporal logic operators:
 - `after`, `at`, and `every` operate on the number of input events, chart invocations (`tick`), and absolute time (`sec`). Use these operators in state on actions and as transition triggers.
 - `count` operates on the number of chart invocations (`tick`).
 - `temporalCount` operates on absolute time (`sec`, `msec`, and `usec`).
 - `elapsed` operates on absolute time (`sec`).

Standalone charts define absolute-time temporal logic in terms of wall-clock time, which is limited to 1 millisecond precision.

- Function `getActiveStates` to access the states that are active during execution of the chart. To store the active states as a cell array, enter:

```
states = getActiveStates(chartObject)
```

- Stateflow function `exportAsClass` that exports the standalone chart as the equivalent MATLAB class. Use this function to debug run-time errors that are otherwise difficult to diagnose. For example, suppose that you encounter an error while executing a Stateflow chart that controls a MATLAB application. If you export the chart as a MATLAB class file, you can replace the chart with the class in your application and diagnose the error by using the MATLAB debugger. To export the chart `chart.sfx` as a class file `chart.m`, enter:

```
Stateflow.exportAsClass('chart.sfx')
```

When you execute the MATLAB class, the Stateflow Editor does not animate the original chart.

Limitations

Content specific to Simulink:

- Sample time and continuous-time semantics.
- C action language.
- Simulink functions and Simulink subsystems as states.
- Input, output, and parameter data.
- Data store memory data.
- Output and local events.
- Input, output, and local messages.

Other limitations:

- No Mealy or Moore semantics.
- No State Transition Tables.
- No Truth Table functions.
- No state-parented local data or functions.
- No transition actions (actions that execute after the source state for the transition is exited but before the destination state is entered).

See Also

`disp` | `edit` | `exportAsClass` | `exportToVersion` | `help`

More About

- “Execute and Unit Test Stateflow Chart Objects” on page 35-8
- “Execute Stateflow Chart Objects Through Scripts and Models” on page 35-18
- “Design Human-Machine Interface Logic by Using Stateflow Charts” on page 35-24
- “Implement a Financial Strategy by Using Stateflow” on page 35-32
- “Model a Communications Protocol by Using Chart Objects” on page 35-28

Execute and Unit Test Stateflow Chart Objects

A standalone Stateflow chart is a MATLAB class that defines the behavior of a finite state machine. Standalone charts implement classic chart semantics with MATLAB as the action language. You can program the chart by using the full functionality of MATLAB, including those functions that are restricted for code generation in Simulink. For more information, see “Create Stateflow Charts for Execution as MATLAB Objects” on page 35-2.

Example of a Standalone Stateflow Chart

The file `sf_chart.sfx` contains the standalone Stateflow chart `sf_chart`. The chart has local data `u`, `x`, and `y`.

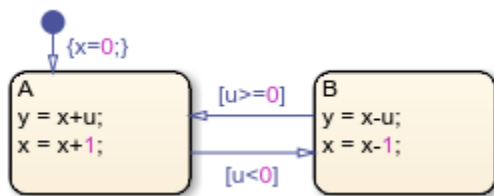

This example shows how to execute this chart from the Stateflow Editor and in the MATLAB Command Window.

Execute a Standalone Chart from the Stateflow Editor

To unit test and debug a standalone chart, you can execute the chart directly from the Stateflow Editor. During execution, you enter data values and broadcast events from the user interface.

- 1 Open the chart in the Stateflow Editor:

```
edit sf_chart.sfx
```

- 2

In the Symbols pane, enter a value of `u = 1` and click **Run** . The chart executes its default transition and:

- Initializes `x` to the value of 0.
- Makes state A the active state.
- Assigns `y` to the value of 1.
- Increases the value of `x` to 1.

The chart animation highlights the active state A. The Symbols pane displays the values `u = 1`, `x = 1`, and `y = 1`. The chart maintains its current state and local data until the next execution command.

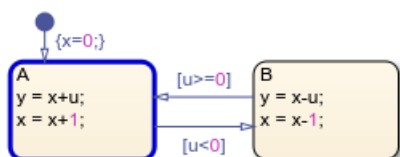

3

Click **Step** . Because the value of u does not satisfy the condition $[u < 0]$ to transition out of state A, this state remains active and the values of x and y increase to 2. The Symbols pane now displays the values $u = 1$, $x = 2$, and $y = 2$.

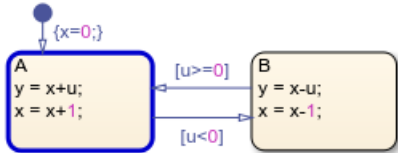

4

In the Symbols pane, enter a value of $u = -1$ and click **Step** . The negative data value triggers the transition to state B. The Symbols pane displays the values $u = -1$, $x = 1$, and $y = 3$.

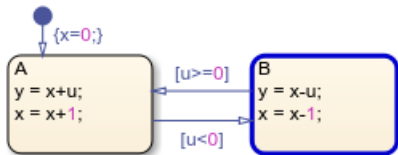

5 You can modify the value of any chart data in the Symbols pane. For example, enter a value of $x = 3$. The chart will use this data value in the next time execution step.

6

Enter a value of $u = 2$ and click **Step** . The chart transitions back to state A. The Symbols pane displays the values $u = 2$, $x = 4$, and $y = 5$.

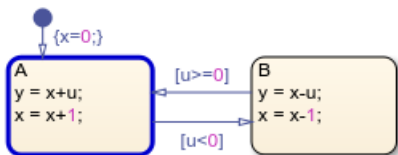

7

To stop the chart animation, click **Stop** .

To interrupt the execution and step through each action in the chart, add breakpoints before you execute the chart. For more information, see “Debug a Standalone Stateflow Chart” on page 35-13.

Execute a Standalone Chart in MATLAB

You can execute a standalone chart in MATLAB without opening the Stateflow Editor. If the chart is open, then the editor highlights active states and transitions through chart animation.

1 Open the chart in the Stateflow Editor. In the MATLAB Command Window, enter:

```
edit sf_chart.sfx
```

2 Create the Stateflow chart object by using the name of the sfx file for the standalone chart as a function. Specify the initial value for the data u as a name-value pair.

```
s = sf_chart('u', 1)
```

Stateflow Chart

Execution Function
`y = step(s)`

Local Data
`u : 1`
`x : 1`
`y : 1`
 Active States: {'A'}

This command creates the chart object `s`, executes the default transition, and initializes the values of `x` and `y`. The Stateflow Editor animates the chart and highlights the active state A.

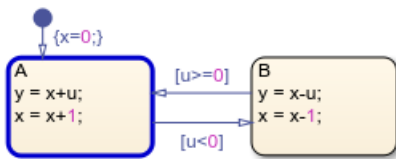

- 3 To execute the chart, call the `step` function. For example, suppose that you call the `step` function with a value of `u = 1`:

```
step(s, 'u', 1)
```

```
disp(s)
```

Stateflow Chart

Execution Function
`y = step(s)`

Local Data
`u : 1`
`x : 2`
`y : 2`
 Active States: {'A'}

Because the value of `u` does not satisfy the condition `[u < 0]` to transition out of state A, this state remains active and the values of `x` and `y` increase to 2.

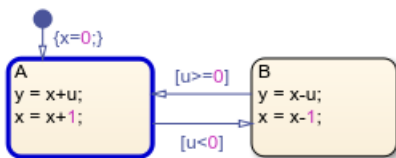

- 4 Execute the chart again, this time with a value of `u = -1`:

```
step(s, 'u', -1)
```

```
disp(s)
```

Stateflow Chart

Execution Function
`y = step(s)`

```

Local Data
  u      : -1
  x      : 1
  y      : 3
Active States: {'B'}

```

The negative data value triggers the transition to state B. The value of x decreases to 1 and the value of y increases to 3.

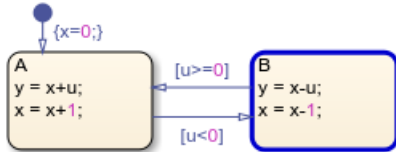

- 5 To access the value of any chart data, use dot notation. For example, you can assign a value of 3 to the local data x by entering:

```
s.x = 3
```

Stateflow Chart

```

Execution Function
y = step(s)

```

```

Local Data
  u      : -1
  x      : 3
  y      : 3
Active States: {'B'}

```

The standalone chart will use this data value in the next time execution step.

- 6 Execute the chart with a value of u = 2:

```
step(s, 'u', 2)
```

```
disp(s)
```

Stateflow Chart

```

Execution Function
y = step(s)

```

```

Local Data
  u      : 2
  x      : 4
  y      : 5
Active States: {'A'}

```

The chart transitions back to state A and modifies the values of x and y.

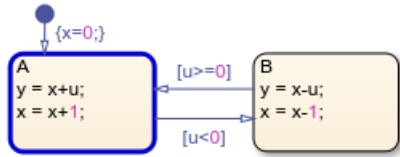

- 7 To stop the chart animation, delete the Stateflow chart object `s`:
`delete(s)`

Execute Multiple Chart Objects

You can execute multiple chart objects defined by the same standalone chart. Concurrent chart objects maintain their internal state independently, but remain associated to the same chart in the editor. The chart animation reflects the state of the chart object most recently executed. Executing multiple chart objects while the Stateflow Editor is open can produce confusing results and is not recommended.

See Also

`delete` | `disp` | `edit`

More About

- “Create Stateflow Charts for Execution as MATLAB Objects” on page 35-2
- “Debug a Standalone Stateflow Chart” on page 35-13
- “Execute Stateflow Chart Objects Through Scripts and Models” on page 35-18
- “Design Human-Machine Interface Logic by Using Stateflow Charts” on page 35-24

Debug a Standalone Stateflow Chart

A standalone Stateflow chart is a MATLAB class that defines the behavior of a finite state machine. Standalone charts implement classic chart semantics with MATLAB as the action language. You can program the chart by using the full functionality of MATLAB, including those functions that are restricted for code generation in Simulink. For more information, see “Create Stateflow Charts for Execution as MATLAB Objects” on page 35-2.

To enable debugging, set a breakpoint in the standalone chart or in a MATLAB script that executes the chart. Breakpoints pause the execution of a chart. While the execution is paused, you can step through each action in the chart, view data values, and interact with the MATLAB workspace to examine the state of the chart.

Note When debugging a standalone chart that you execute from a MATLAB script, first open the Stateflow Editor. Attempting to debug a standalone chart before opening the editor at least once can produce unexpected results.

For information on debugging Stateflow charts in Simulink models, see “Debugging Stateflow Charts” on page 33-2.

Set and Clear Breakpoints

Breakpoints appear as circular red badges. For example, this chart contains breakpoints on the state A and on the transition from A to B.

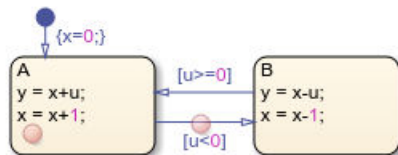

You can set breakpoints on charts, states, and transitions.

Breakpoints on Charts

To set a breakpoint on a chart, right-click inside the chart and select **Set Breakpoint on Chart Entry**. This type of breakpoint pauses the execution before entering the chart.

To remove the breakpoint, right-click inside the chart and clear the **Set Breakpoint on Chart Entry** option.

Breakpoints on States and Transitions

You can set different types of breakpoints on states and transitions.

Object	Breakpoint Type
State	On State Entry — Pause the execution before performing the state entry actions.

Object	Breakpoint Type
	During State — Pause the execution before performing the state during actions.
	On State Exit — Pause the execution after performing the state exit actions.
Transition	When Transition is Tested — Pause the execution before testing that the transition is a valid path. If no condition exists on the transition, this breakpoint type is not available.
	When Transition is Valid — Pause the execution after the transition is valid, but before taking the transition.

To set a breakpoint on a state or transition, right-click the state or transition and select **Set Breakpoint**. For states, the default breakpoints are **On State Entry** and **During State**. For transitions, the default breakpoint is **When Transition is Valid**. To change the type of breakpoint, click the breakpoint badge and select a different configuration of breakpoints. For more information, see “Manage Breakpoint Types and Conditions” on page 35-14.

To remove the breakpoint, right-click the state or transition and select **Clear Breakpoint**. To remove all of the breakpoints in a chart, right-click inside the chart and select **Clear All Breakpoints In Chart**.

Manage Breakpoint Types and Conditions

A breakpoint badge can represent more than one type of breakpoint. To see a tooltip that lists the breakpoint types that are set on a state or transition, point to its badge. In this example, the badge on the state A represents two breakpoint types: **On State Entry** and **During State**.

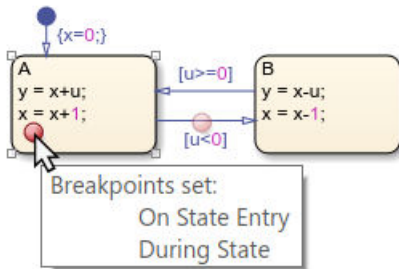

To change the type of breakpoint on an object, click the breakpoint badge. In the Breakpoints dialog box, you can select a different configuration of breakpoints, depending on the object type. Clearing all of the check boxes in the Breakpoints dialog box removes the breakpoint.

<input checked="" type="checkbox"/> On State Entry	<input type="text"/>
<input checked="" type="checkbox"/> During State	<input type="text"/>
<input type="checkbox"/> On State Exit	<input type="text"/>

To limit the number of times that the execution stops at a breakpoint, add a condition to the breakpoint. By default, a Stateflow chart pauses whenever it reaches a breakpoint. When you add a condition to a breakpoint, the chart pauses at the breakpoint only when the condition is true. For

example, with these conditions, the breakpoints on state A pause the execution of the chart only when the value of x is negative.

<input checked="" type="checkbox"/> On State Entry	<input type="text" value="x<0"/>
<input checked="" type="checkbox"/> During State	<input type="text" value="x<0"/>
<input type="checkbox"/> On State Exit	<input type="text"/>

To specify a condition for the breakpoint, you can use any valid MATLAB expression that combines numerical values and Stateflow data objects that are in scope at the breakpoint.

Control Chart Execution After a Breakpoint

When execution stops at a breakpoint, Stateflow enters debugging mode.

- The MATLAB command prompt changes to K>>.
- The Symbols pane displays the value of each data object in the chart.
- The chart highlights active elements in blue and the currently executing object in green.

For example, when the execution stops at the breakpoint in state A, the border of the state and the first statement in the state entry action appear highlighted in green.

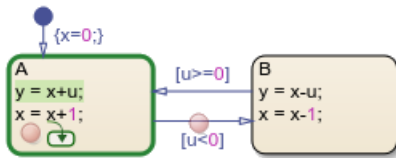



An execution status badge appears in the graphical object where execution pauses.

Badge	Description
	Execution is paused before entering a chart or in a state entry action.
	Execution is paused in a state during action.
	Execution is paused in a state exit action.
	Execution is paused before testing a transition.
	Execution is paused before taking a valid transition.

When the chart is paused at a breakpoint, you can continue the execution by using:

- Buttons in the **Debug** tab
- The MATLAB Command Window
- Keyboard shortcuts

Action	Debug Tab Button	MATLAB Command	Keyboard Shortcut	Description
Continue		dbcont	Ctrl+T	Continue execution to the next breakpoint.
Step Over		dbstep	F10	Advance to the next step in the chart execution. At the chart level, possible steps include: <ul style="list-style-type: none"> • Enter the chart • Execute a transition action • Activate a state • Execute a state action For more information, see “Execution of a Stateflow Chart” on page 3-23.
Step In		dbstep in	F11	From a state or transition action that calls a function, advance to the first executable statement in the function. From a statement in a function containing another function call, advance to the first executable statement in the second function. Otherwise, advance to the next step in the chart execution. (See the Step Over option.)
Step Out		dbstep out	Shift+F11	From a function call, return to the statement calling the function. Otherwise, continue execution to the next breakpoint. (See the Continue option.)
Stop		dbquit	Ctrl+Shift+T	Exit debug mode and interrupt the execution. When you execute the standalone chart from the Stateflow Editor, this action removes the chart object from the MATLAB workspace.

In state or transition actions containing more than one statement, you can step through the individual statements one at a time by selecting **Step Over**. The Stateflow Editor highlights each statement before executing it.

Note Because standalone charts define temporal logic in terms of wall-clock time, a temporal logic operator can become valid while a chart is paused at a breakpoint. In this case, the chart exits debugging mode and the execution continues to the next breakpoint.

Examine and Change Values of Chart Data

When Stateflow is in debug mode, the Symbols pane displays the value of each data object in the chart. You can also examine data values by pointing to a state or a transition in the chart. A tooltip displays the value of each data object used in the selected state or transition.

To test the behavior of your chart, in the Symbols pane, you can change the value of a data object during execution. Alternatively, at the debugging prompt, enter the new value by using the name `this` in place of the chart object name. For instance, to change the value of the local data `x`, enter:

```
this.x = 7
```

The new value appears in the Symbols pane.

Note While the Stateflow is in debug mode, the workspace variable `this` contains a handle to the chart object. To avoid unexpected behavior, do not overwrite `this` with a different value.

See Also

More About

- “Create Stateflow Charts for Execution as MATLAB Objects” on page 35-2
- “Execute and Unit Test Stateflow Chart Objects” on page 35-8
- “Debugging Stateflow Charts” on page 33-2

Execute Stateflow Chart Objects Through Scripts and Models

A standalone Stateflow chart is a MATLAB class that defines the behavior of a finite state machine. Standalone charts implement classic chart semantics with MATLAB as the action language. You can program the chart by using the full functionality of MATLAB, including those functions that are restricted for code generation in Simulink. For more information, see “Create Stateflow Charts for Execution as MATLAB Objects” on page 35-2.

This example shows how to execute a standalone Stateflow chart by using a MATLAB script or a Simulink model.

Count Ways to Make Change for Currency

The file `sf_change.sfx` defines a standalone Stateflow chart that counts the number of ways to make change for a given amount of money. The chart contains these data objects:

- `x` is the amount of money to change. The default value is 100.
- `coinValues` is a vector of coin denominations arranged in increasing order. `coinNames` is an array of corresponding coin names. The default values represent standard American coins (pennies, nickels, dimes, and quarters).
- `tally` is the number of valid change configurations.
- `tabula` is an array containing the different valid change configurations.
- `chg`, `done`, `i`, and `n` are local data used by the change-counting algorithm.
- `textWidth` and `quietMode` are local data that control how the chart displays its results.

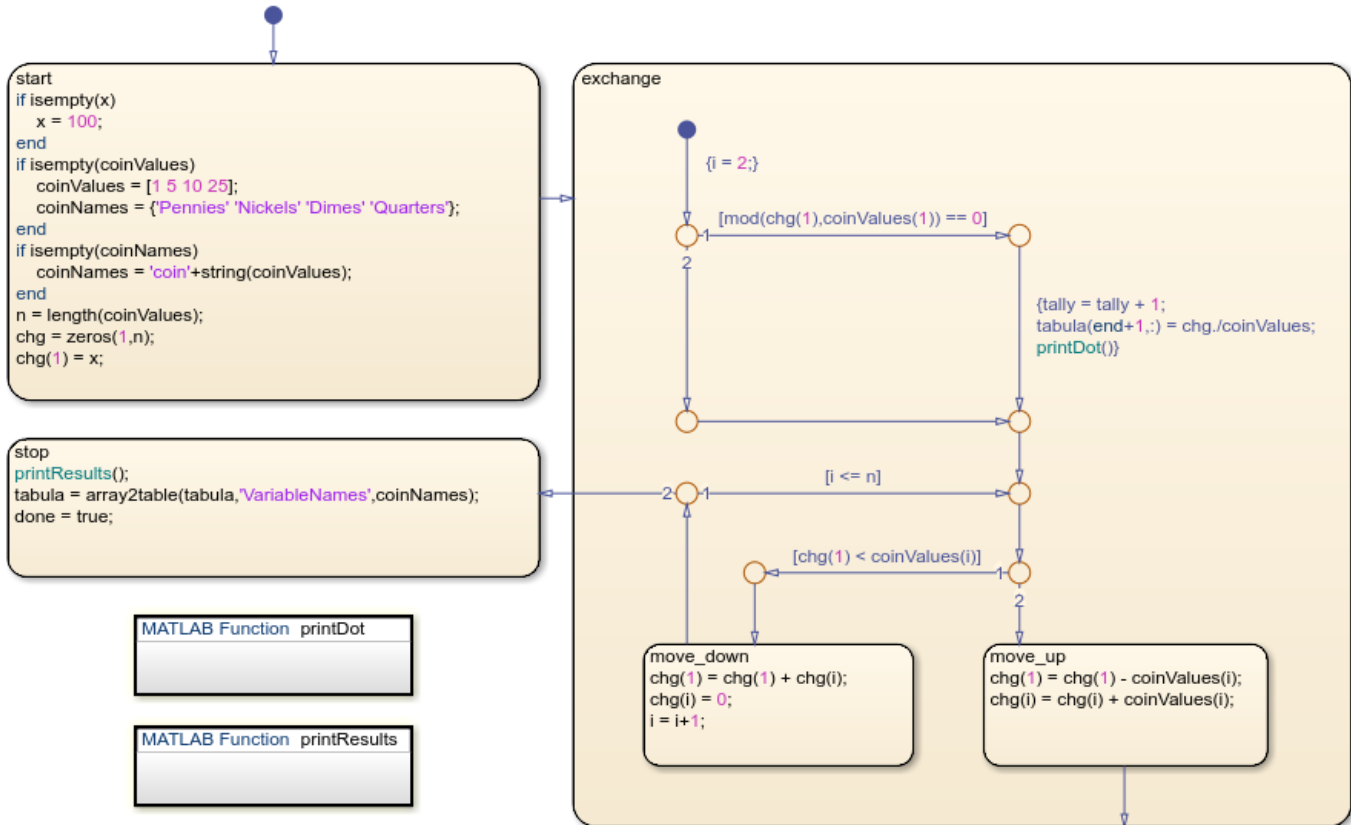

Copyright 2018-2020 The MathWorks, Inc.

The chart begins with a potential change configuration consisting entirely of the lowest-value coins, specified by an index of 1. At each execution step, the state exchange modifies this configuration in one of two ways:

- The substate `move_up` exchanges some lowest-value coins for a coin with a higher value, specified by the index `i`.
- The substate `move_down` exchanges all of the coins with the value specified by the index `i` for lowest-value coins. Then `move_up` exchanges some lowest-value coins for a coin with a value specified by the index `i+1` or higher.

A potential change configuration is valid when the number of cents represented by the lowest-value coins is divisible by the value of that type of coin. When the chart encounters a new valid configuration, it increments `tally` and appends the new configuration to `tabula`.

When no more coin exchanges are possible, the state `stop` becomes active. This state prints the results of the computation, transforms the contents of `tabula` to a table, and sets the value of `done` to `true`.

Execute Standalone Chart in a MATLAB Script

To run the change-counting algorithm to completion, you must execute the standalone chart multiple times. For example, the MATLAB script `sf_change_script.m` creates a chart object `chartObj` and initializes the value of the local data `x` to 27. The configuration option `'`

`warningOnUninitializedData`', which the script sets to `false`, eliminates the warning that `tabula` is an empty array in the new chart object. The `while` loop executes the chart until the local data `done` becomes `true`. Finally, the script displays the value of `tabula`.

```
chartObj = sf_change('x',27,'--warningOnUninitializedData',false);

while ~chartObj.done
    step(chartObj);
end

disp(chartObj.tabula)
```

When you run this script, the standalone chart calculates the number of ways to make change for 27 cents by using standard American coins:

```
sf_change_script
```

```
.....
There are 13 ways to make change for 27 cents.
  Pennies   Nickels   Dimes   Quarters
  _____
    27         0         0         0
    22         1         0         0
    17         2         0         0
    12         3         0         0
     7         4         0         0
     2         5         0         0
    17         0         1         0
    12         1         1         0
     7         2         1         0
     2         3         1         0
     7         0         2         0
     2         1         2         0
     2         0         0         1
```

To determine the number of ways to make change for a different amount, or to use a different system of currency, change the values of `x` and `coinValues`. For example, to use British currency, initialize `coinValues` to `[1 2 5 10 20 25 50]`.

Execute Standalone Chart in a Simulink Model

You can execute a standalone Stateflow chart from within a Simulink model. For example, the model `sf_change_model` contains two Stateflow charts that use the standalone chart `sf_change` to count the number of ways to make change for 27 cents in two different currency systems. You can simulate the model, but the functions that execute the standalone chart do not support code generation.

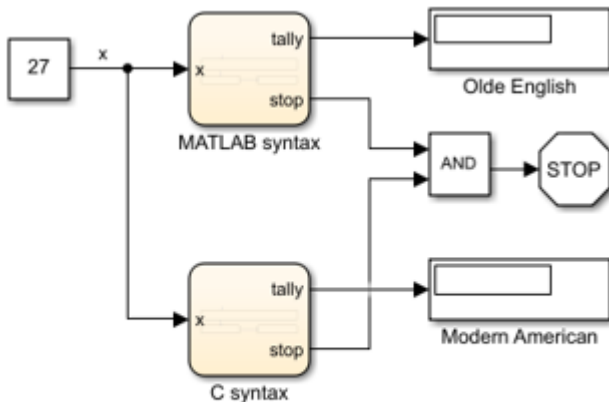

Copyright 2018-2020 The MathWorks, Inc.

Each chart contains these states:

- `Initialize` creates a local chart object `chartObj` that implements the change-counting algorithm for the input value `x`.
- `Execute` calls the `step` function to execute the standalone chart and stores the result as the output data `tally`.
- `Finish` displays the results of the algorithm in the Diagnostic Viewer window and sets the value of the output data `done` to `true`.

When both charts reach their respective `Finish` state, the simulation of the model stops and the `Display` blocks show the final values of the two tallies.

Execution Using MATLAB as the Action Language

The chart `MATLAB syntax` uses MATLAB as the action language. To execute the standalone Stateflow chart, this chart must follow these guidelines:

- The local variable `chartObj` that contains the handle to the chart object has type `Inherit`:
From definition in `chart`.
- Before creating the chart object, the `Initialize` state calls the `coder.extrinsic` function to declare `sf_change` as an extrinsic function that is restricted for code generation in Simulink. See “Call Extrinsic MATLAB Functions in Stateflow Charts” on page 31-26.
- The `Execute` and `Finish` states access the local data for the standalone chart by calling the `get` function.

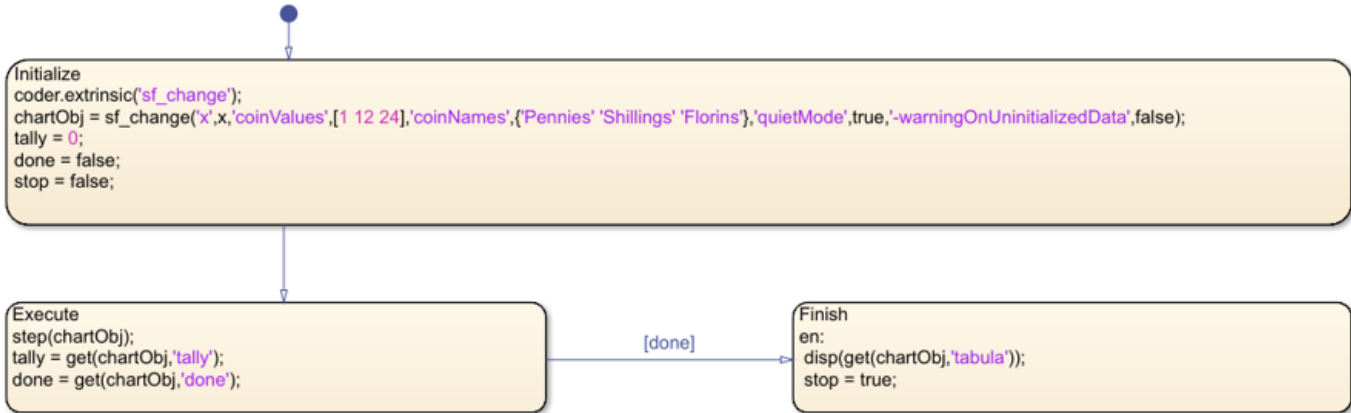

When you simulate this chart with an input of $x = 27$, the Display block *Old English* shows a tally of 4. The Diagnostic Viewer window shows these results:

Pennies	Shillings	Florins
27	0	0
15	1	0
3	2	0
3	0	1

Execution Using C as the Action Language

The chart C syntax uses C as the action language. To execute the standalone Stateflow chart, this chart must follow these guidelines:

- The local variable `chartObj` that contains the handle to the chart object has type `ml`.
- The **Initialize** state calls the `ml` function to create the chart object.
- The **Execute** and **Finish** states use the `ml` namespace operator to access the `step`, `get`, and `disp` functions to execute the standalone chart, access its local data, and display the results of the algorithm.

For more information, see “Access MATLAB Functions and Workspace Data in C Charts” on page 13-28.

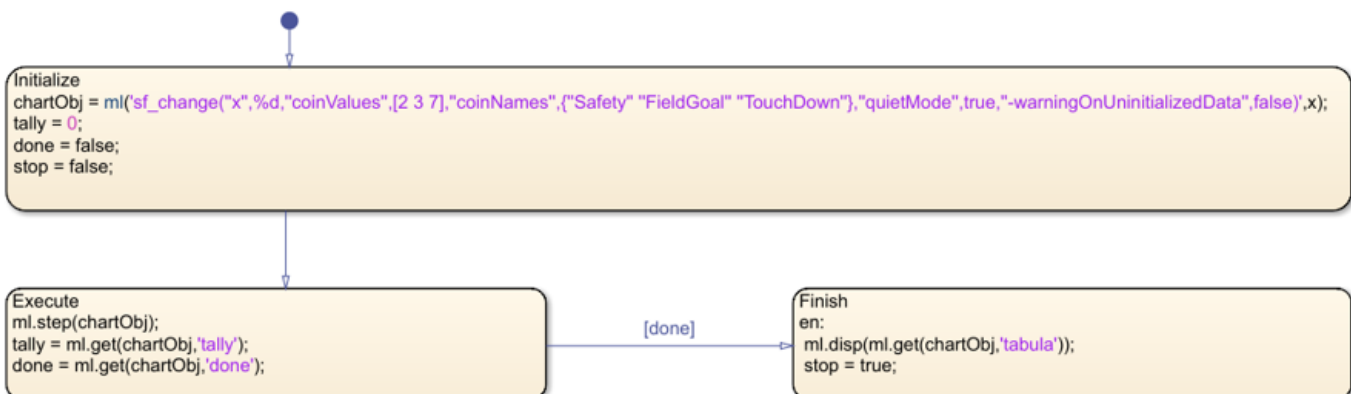

When you simulate this chart with an input of $x = 27$, the Display block Modern American shows a tally of 13. The Diagnostic Viewer window shows these results:

Safety	FieldGoal	TouchDown
12	1	0
9	3	0
6	5	0
3	7	0
0	9	0
10	0	1
7	2	1
4	4	1
1	6	1
5	1	2
2	3	2
3	0	3
0	2	3

See Also

More About

- “Create Stateflow Charts for Execution as MATLAB Objects” on page 35-2
- “Execute and Unit Test Stateflow Chart Objects” on page 35-8
- “Call Extrinsic MATLAB Functions in Stateflow Charts” on page 31-26
- “Access MATLAB Functions and Workspace Data in C Charts” on page 13-28

Design Human-Machine Interface Logic by Using Stateflow Charts

This example shows how to model the logic of a graphical user interface in a standalone Stateflow® chart. Standalone charts implement classic chart semantics with MATLAB® as the action language. You can program the chart by using the full functionality of MATLAB, including those functions that are restricted for code generation in Simulink®. For more information, see “Create Stateflow Charts for Execution as MATLAB Objects” on page 35-2.

You can execute a standalone Stateflow chart by invoking its input events and using temporal operators. The event- and timer-driven execution workflow is suitable for designing the logic underlying human-machine interfaces (HMIs) and graphical user interfaces (UIs).

- When you use the MATLAB App Designer, callback functions from the interface widgets invoke events in the chart.
- In the Stateflow chart, temporal operators and local data control the properties of the user interface.

For more information on how to use MATLAB to create graphical user interfaces, see “Develop Apps Using App Designer” (MATLAB).

Control an App Designer User Interface

This user interface contains an On-Off switch that controls a lamp. When the switch is in the On position, the lamp lights up in one of two modes, solid or blinking, depending on the position of the Mode option button. You control the rate of blinking by moving the Blink Rate slider.

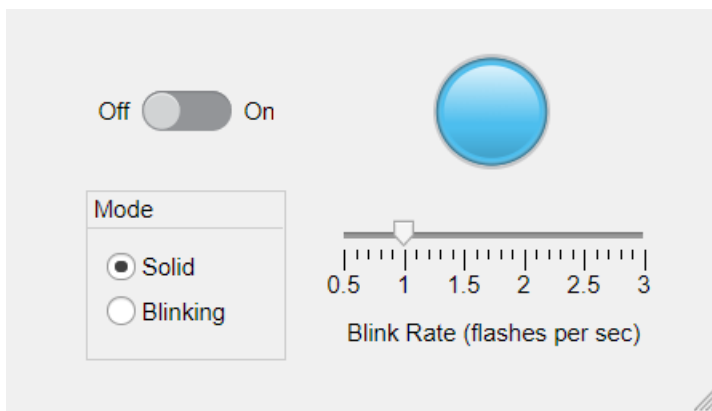

The file `sf_lamp_logic.sfx` defines a standalone Stateflow chart that implements the logic for the user interface. The chart has input events (`ON`, `OFF`, `BLINKING`, and `SOLID`) and local data (`delay` and `app`). The actions in the chart control which widgets are accessible from each state. For instance, the actions in the `Off` state cause the Lamp widget, the Mode option buttons, and the Blink Rate slider in the user interface to appear dimmed.

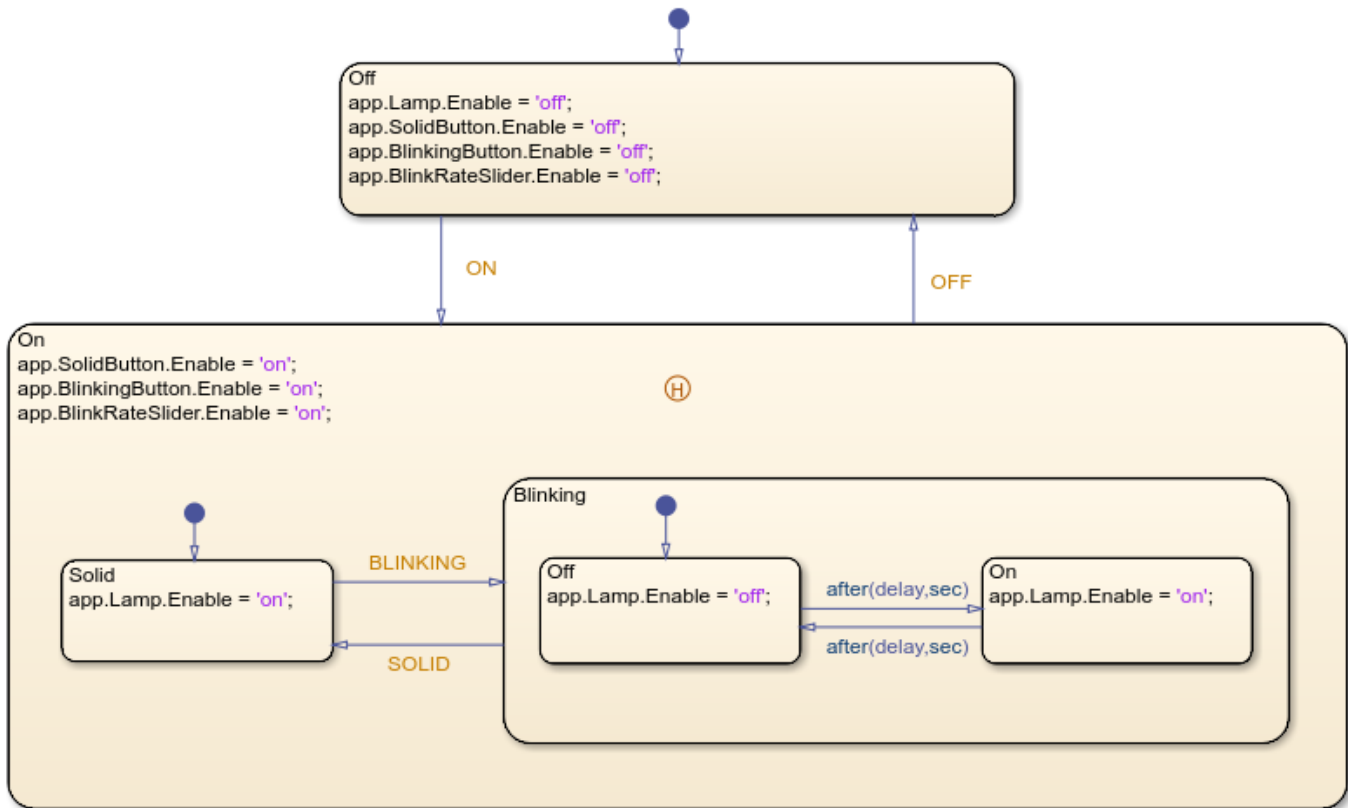

Copyright 2018-2020 The MathWorks, Inc.

In the On state, the substates Solid and Blinking denote the two modes of operation. To implement a blinking lamp, the chart relies on the temporal logic operator `after`. When the chart enters the state `Blinking.Off`, the expression `after(delay,sec)` on the outgoing transition creates a MATLAB timer object that executes the chart after a number of seconds. The chart then transitions to the state `Blinking.On` and creates another timer object to trigger the transition back to `Blinking.Off`. While the chart continually transitions between the two states, you can adjust the rate of blinking by changing the value of the local data `delay` or transition out of blinking mode by invoking the input events `SOLID` or `OFF`.

The history junction in the On state preserves information on the most recently active substate so that the user interface returns to the previous mode of operation when you turn on the lamp.

Execute Standalone Chart by Using Events

You can execute the standalone chart by calling its input event functions in the MATLAB Command Window. The Stateflow Editor shows the effects of each of these commands by highlighting active states and transitions through chart animation.

1. Open the standalone chart in the Stateflow Editor.

```
edit sf_lamp_logic.sfx
```

2. Create the chart object `L` and initialize the value of `delay` to 0.5. This value corresponds to a blinking rate of one flash per second.

```
L = sf_lamp_logic('delay',0.5);
```

3. Turn on the lamp.

```
ON(L)
```

4. Switch to blinking mode.

```
BLINKING(L)
```

5. Set the value of `delay` to 0.25. This value corresponds to a blinking rate of two flashes per second.

```
L.delay = 0.25;
```

6. Switch to solid mode.

```
SOLID(L)
```

7. Turn off the lamp.

```
OFF(L)
```

8. Delete the chart object `L` from the MATLAB workspace.

```
delete(L)
```

Connect Standalone Chart to User Interface

To establish a bidirectional connection between the user interface and the standalone Stateflow chart, open the App Designer window and select **Code View**.

1. In the App Designer window, create a private property `lampLogic` to store the handle to the Stateflow chart object.

```
properties (Access = private)
    lampLogic
end
```

2. Create a `StartupFcn` callback function that creates the chart object and sets its local data `app` to the user interface handle. Assign the chart object handle to the `lampLogic` private property.

```
% Code that executes after component creation
function StartupFcn(app)
    app.lampLogic = sf_lamp_logic('delay',0.5,'app',app);
end
```

3. Create a `CloseRequestFcn` callback function that deletes the chart object when you close the user interface.

```
% Close request function: UIFigure
function UIFigureCloseRequest(app, event)
    delete(app.lampLogic);
    delete(app);
end
```

4. For each one of the user interface widgets, add a callback function that invokes the appropriate event on the standalone chart.

- ValueChangedFcn callback function for Switch widget:

```
function SwitchValueChanged(app,event)
    value = app.Switch.Value;
    switch lower(value)
        case 'off'
            OFF(app.lampLogic);
        case 'on'
            ON(app.lampLogic);
    end
end
```

- SelectionChangedFcn callback function for Mode Button widget:

```
function ModeButtonGroupSelectionChanged(app,event)
    selectedButton = app.ModeButtonGroup.SelectedObject;
    if app.SolidButton == selectedButton
        SOLID(app.lampLogic);
    else
        BLINKING(app.lampLogic);
    end
end
```

- ValueChangedFcn callback function for Blink Rate Slider widget:

```
function BlinkRateSliderValueChanged(app,event)
    app.lampLogic.delay = round(0.5/app.BlinkRateSlider.Value,2);
end
```

When you run the user interface, you can observe the effects of adjusting the control widgets on the chart canvas and on the lamp widget.

See Also

after

More About

- “Create Stateflow Charts for Execution as MATLAB Objects” on page 35-2
- “Activate a Stateflow Chart by Sending Input Events” on page 11-7
- “Control Chart Execution by Using Temporal Logic” on page 13-40
- “Record State Activity by Using History Junctions” on page 8-2
- “Develop Apps Using App Designer” (MATLAB)

Model a Communications Protocol by Using Chart Objects

This example shows how to use a standalone Stateflow® chart to model a frame-synchronization and symbol-detection component in a communications system. Standalone charts implement classic chart semantics with MATLAB® as the action language. You can program the chart by using the full functionality of MATLAB, including those functions that are restricted for code generation in Simulink®. For more information, see “Create Stateflow Charts for Execution as MATLAB Objects” on page 35-2.

Implement a Symbol-Detection Algorithm

In this example, the input to the communications system consists of a binary signal of zeros and ones received every 10 milliseconds. The input signal can contain any combination of:

- A 770-ms pulse (77 consecutive ones) to mark the beginning and end of a frame of data and to ensure system synchronization.
- A 170-ms pulse (17 consecutive ones) to indicate symbol A.
- A 470-ms pulse (47 consecutive ones) to indicate symbol B.

The file `sf_frame_search.sfx` defines a standalone Stateflow chart that implements this communication protocol. The chart consists of two outer states in parallel decomposition. The `Initialize` state resets the value of the local data `symbol` at the start of each execution step. The `Search` state contains the logic that defines the symbol-detection algorithm. When this state detects one of the pulses allowed by the communication protocol, the name of the corresponding symbol is stored as `symbol` and displayed in the MATLAB Command Window. Parallel decomposition enables the chart to preprocess the input data. For more information, see “State Decomposition” on page 2-16.

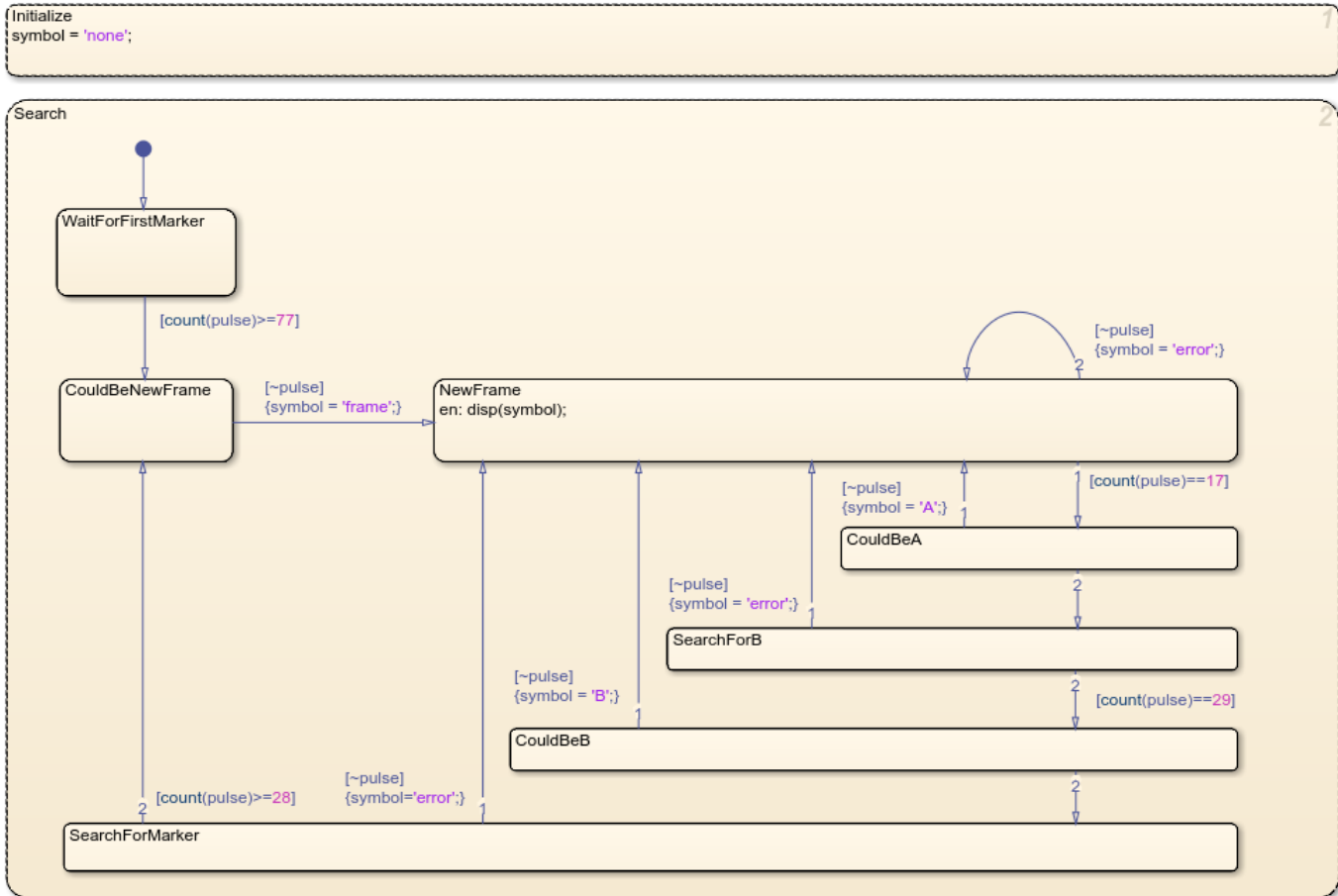

To track the length of a pulse through several execution steps, the chart uses the count operator. This operator simplifies the design of the chart by eliminating the need for a manual counter. For example, the condition `[count(pulse)==17]` guards the outgoing transition from the substate **NewFrame**. This condition becomes true when the data `pulse` is one for 17 consecutive execution steps. In this case, the chart transitions to the **CouldBeA** substate. If this transition is followed by an input of zero, then the chart registers the reception of symbol A and transitions back to the **NewFrame** substate. Otherwise, the chart transitions to the **SearchForB** state from which the condition `[count(pulse)==29]` searches for an additional 29 ones to mark symbol B.

Execute Standalone Chart

In the MATLAB script `sf_frame_tester.m`, the sample code generates a short signal consisting of several valid pulses and one transmission error. The error consists of a 470-ms pulse that is too long to represent symbol A and too short to represent symbol B.

```
f = sf_frame_search('pulse','0');    % create chart object
sendPulse(f,77);                    % frame marker
sendPulse(f,17);                    % A
sendPulse(f,47);                    % B
sendPulse(f,37);                    % transmission error
sendPulse(f,47);                    % B
```

```

sendPulse(f,17);           % A
sendPulse(f,77);          % frame marker
delete(f);                 % delete chart object

function sendPulse(f,n)
% Send a pulse of n ones and one zero to chart object f.

    for i = 1:n
        step(f,'pulse',1)
        printDot(1)
    end

    printDot(0)
    step(f,'pulse',0)

    function printDot(x)
        persistent k
        if isempty(k)
            k = 1;
        end

        if x == 0
            fprintf('\n');
            k = 1;
        elseif k == 50
            fprintf('\n');
            k = 1;
        else
            fprintf('.');
            k = k+1;
        end
    end
end
end

```

Running the script produces these results in the MATLAB Command Window:

```

.....
.....
frame
.....
A
.....
B
.....
error
.....
B
.....
A.....
.....
frame

```

See Also

count

More About

- “Create Stateflow Charts for Execution as MATLAB Objects” on page 35-2
- “Execute Stateflow Chart Objects Through Scripts and Models” on page 35-18
- “Control Chart Execution by Using Temporal Logic” on page 13-40
- “State Decomposition” on page 2-16

Implement a Financial Strategy by Using Stateflow

This example shows how to use a standalone Stateflow® chart to model a financial trading strategy known as *Bollinger Bands*. Standalone charts implement classic chart semantics with MATLAB® as the action language. You can program the chart by using the full functionality of MATLAB, including those functions that are restricted for code generation in Simulink®. For more information, see “Create Stateflow Charts for Execution as MATLAB Objects” on page 35-2.

Compute Bollinger Bands

The Bollinger Bands trading strategy is to maintain a moving average of N stock prices for some commodity and issuing trading instructions depending on the value of the stock:

- "Buy" when the value of the stock drops K standard deviations below the moving average.
- "Sell" when the value of the stock rises K standard deviations above the moving average.
- "Hold" when the value of the stock is within K standard deviations of the moving average.

Typical implementations for this strategy use values of $N = 20$ and $K = 2$.

The file `sf_stock_watch.sfx` defines a standalone Stateflow chart that implements this financial strategy. The chart consists of two outer states in parallel decomposition.

- The `StockTicker` subchart records the current price of a stock. The subchart hides the details for calculating stock prices. To access real-time market data from financial data providers, one possible implementation involves the use of the Datafeed Toolbox™. For details, see “Datafeed Toolbox”.
- The `FinancialAdvisor` state uses the last N stock prices to compute high and low bands. Depending on the current price relative to these bands, the state generates "buy," "sell," or "hold" instructions. The action on `every(1, sec)` creates a MATLAB® timer to execute the chart every second. See “Control Chart Execution by Using Temporal Logic” on page 13-40.

Parallel decomposition is a common design pattern that enables your algorithm to preprocess input data. For more information, see “State Decomposition” on page 2-16.

StockTicker

1

FinancialAdvisor

2

```

entry:
buffer = [price];
on every(1,sec):
if length(buffer) == N
    buffer(1) = [];
end
buffer(end+1) = price;

```

```

BurnIn
en:
fprintf('Loading data... Ready in 5 ');
du:
fprintf('%d ', 5 - length(buffer));
ex:
fprintf('0: \n');

```

[length(buffer)>=5]

Trade

```

en,du:
sigma = std(buffer);
mid = mean(buffer);
low = mid-K*sigma;
high = mid+K*sigma;

```

```

flat
fprintf('HOLD at %g\n',price);

```

[price>=0.5*(mid+low)]

2 [price<low]

[price>high]

[price<=0.5*(mid+high)]

```

long
fprintf('BUY at %g\n',price);

```

```

short
fprintf('SELL at %g\n',price);

```

Copyright 2018-2020 The MathWorks, Inc.

Execute Standalone Chart

To execute the standalone chart, create a Stateflow chart object *w*:

```
w = sf_stock_watch();
```

The chart generates a stream of stock prices and issues "buy," "sell," or "hold" instructions.

Note: Chart execution continues until you delete the chart object.

```

Loading data... Ready in 5 4 3 2 1 0:
HOLD at 14.1942

```

SELL at 14.2802
SELL at 14.247
HOLD at 14.2025
BUY at 14.1444

To stop the chart execution, delete the chart object w:

```
delete(w);
```

See Also

More About

- “Create Stateflow Charts for Execution as MATLAB Objects” on page 35-2
- “Control Chart Execution by Using Temporal Logic” on page 13-40
- “State Decomposition” on page 2-16
- “Datafeed Toolbox”

Automate Control of Intelligent Vehicles by Using Stateflow Charts

This example shows how to model a highway scenario with intelligent vehicles that are controlled by the same decision logic. Each vehicle determines when to speed up, slow down, or change lanes based on the logic defined by a standalone Stateflow® chart. Because the driving conditions (including the relative position and speed of nearby vehicles) differ from vehicle to vehicle, separate chart objects in MATLAB® control the individual vehicles on the highway.

Open Driving Scenario

Open the example to display a 3-D animation of a long highway and several vehicles. The view focuses on a single vehicle and its surroundings. As this vehicle moves along the highway, a Stateflow chart shows the decision logic that determines its actions. To replay the animation, run the MATLAB script `sf_driver_demo`.

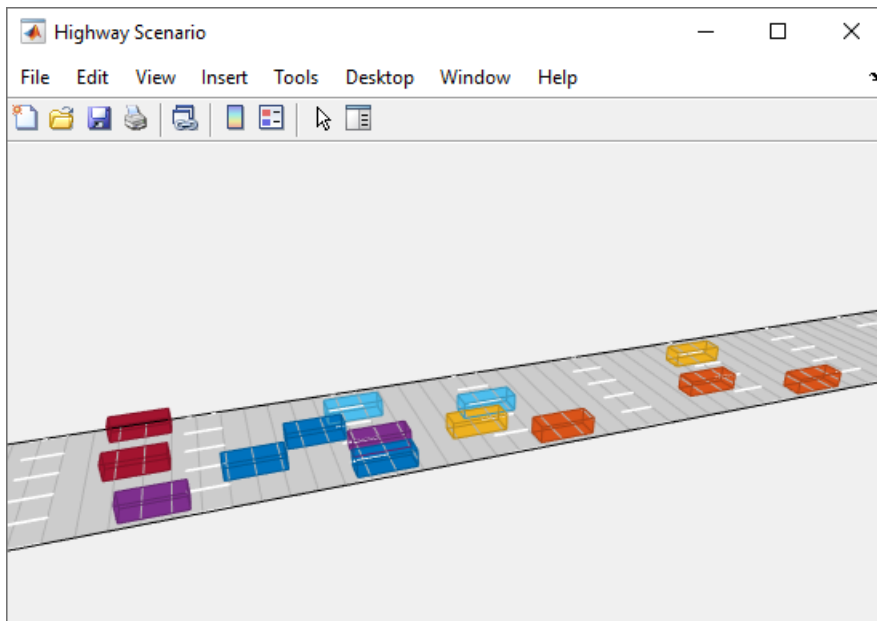

Starting from a random position, each vehicle attempts to travel at a target speed. Because the target speeds are chosen at random, the vehicles can obstruct one another. In this situation, a vehicle will try to change lanes and resume its target speed.

The class file `HighwayScenario` defines a `drivingScenario` object that represents the 3-D environment that contains the highway and the vehicles on it. To control the motion of the vehicles, the `drivingScenario` object creates an array of Stateflow chart objects. Each chart object controls a single vehicle by executing the decision logic in the standalone chart `sf_driver`.

Execute Decision Logic for Vehicles

The Stateflow chart `sf_driver` consists of two top-level states, `LaneKeep` and `LaneChange`.

When the `LaneKeep` state is active, the corresponding vehicle stays in its lane of traffic. In this state, there are two possible substates:

- **Cruise** is active when the zone directly in front of the vehicle is empty and the vehicle can travel at its target speed.
- **Follow** becomes active when the zone directly in front of the vehicle is occupied and its target speed is faster than the speed of the vehicle in front. In this case, the vehicle is forced to slow down and attempt to change lanes.

When the LaneChange state is active, the corresponding vehicle attempts to change lanes. In this state, there are two possible substates:

- **Continue** is active when the zone next to the vehicle is empty and the vehicle can change lanes safely.
- **Abort** becomes active when the zone next to the vehicle is occupied. In this case, the vehicle is forced to remain in its lane.

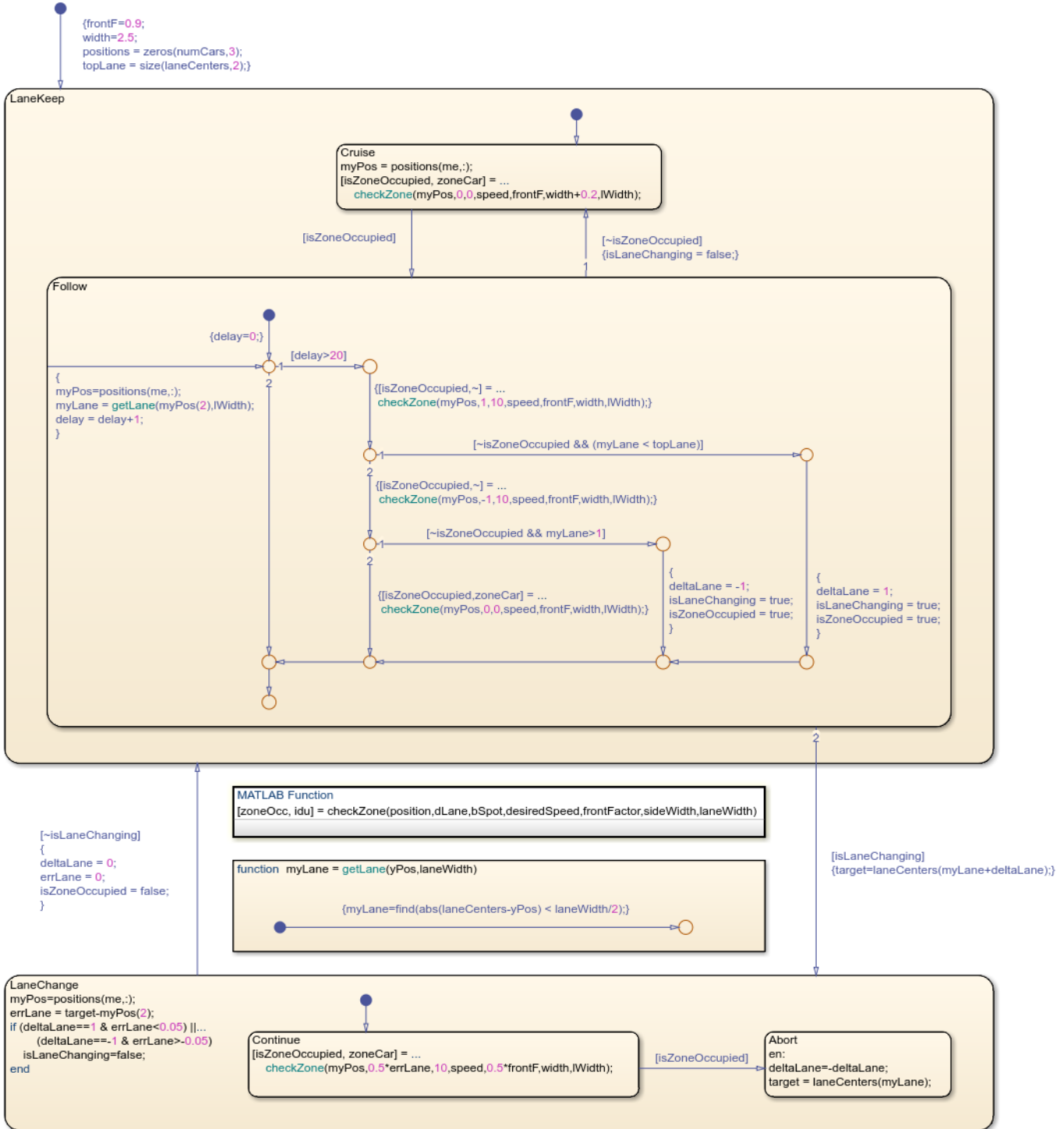

The transitions between the states LaneKeep and LaneChange are guarded by the value of isLaneChanging. In the LaneKeep state, the chart sets this local data to true when the substate

Follow is active and there is enough room beside the vehicle to change lanes. In the LaneChange state, the chart sets this local data to false when the vehicle finishes changing lanes.

See Also

drivingScenario

More About

- “Create Stateflow Charts for Execution as MATLAB Objects” on page 35-2
- “Driving Scenario Tutorial” (Automated Driving Toolbox)
- “Create Actor and Vehicle Trajectories” (Automated Driving Toolbox)
- “Define Road Layouts” (Automated Driving Toolbox)

Create an App for Analog Triggered Data Acquisition by Using Stateflow Charts

This example shows how to create an analog-triggered data acquisition app by using Stateflow®, Data Acquisition Toolbox™, and App Designer.

Data Acquisition Toolbox provides functionality for acquiring measurement data from a DAQ device or audio soundcard. For certain applications, an analog-triggered acquisition that starts capturing or logging data based on a condition in the analog signal being measured is recommended. Software-analog triggered acquisition enables you to capture only a segment of interest out of a continuous stream of measurement data. For example, you can capture an audio recording when the signal level passes a certain threshold.

This example app, created by using App Designer and Stateflow, shows how to implement these operations:

- Control the app state logic by using a Stateflow chart.
- Discover available DAQ devices and select which device to use.
- Configure device acquisition parameters.
- Display a live plot in the app UI during acquisition.
- Perform a triggered data capture based on a programmable trigger condition.
- Save captured data to a MATLAB® base workspace variable.

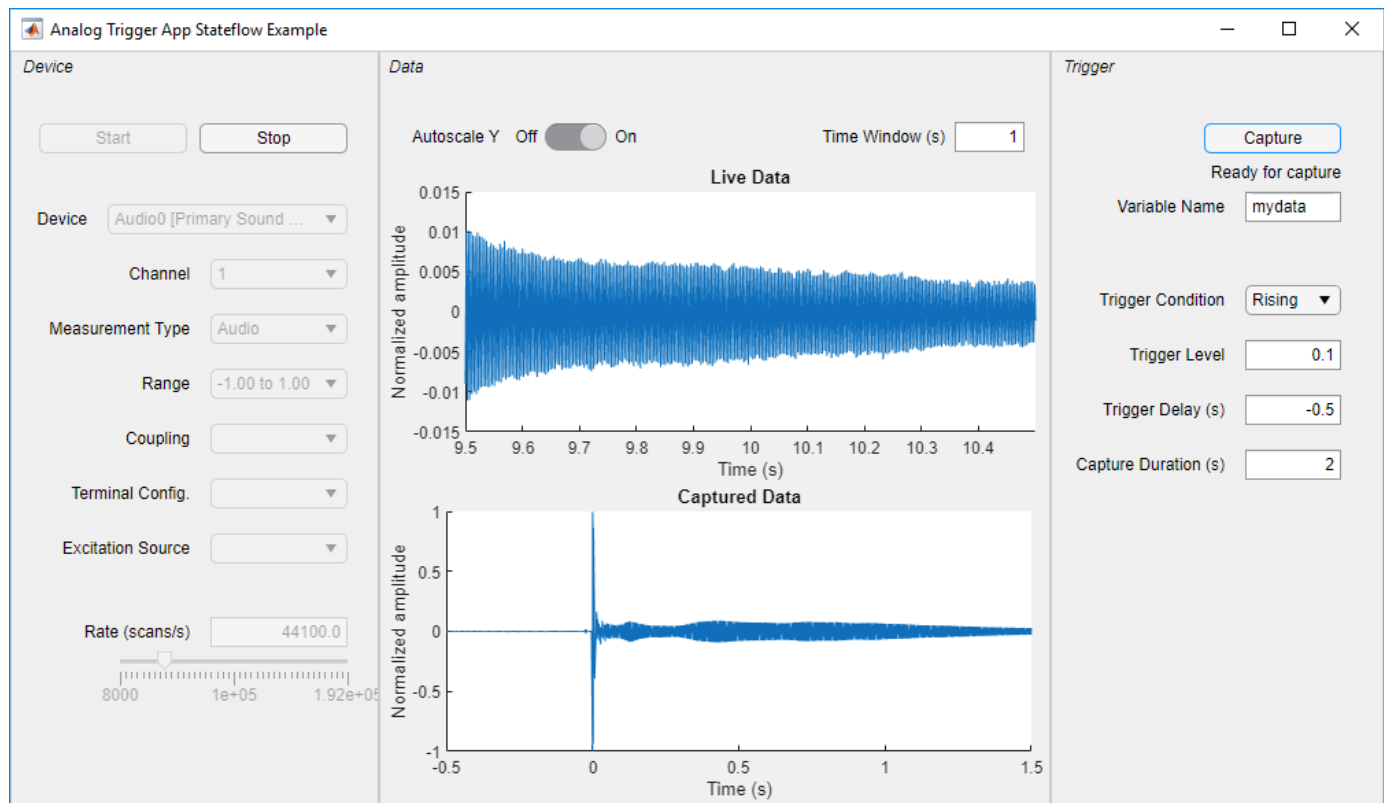

By default, the app opens in design mode in App Designer. To run the app click the **Run** button or execute the app from the command line:

```
AnalogTriggerAppStateflow
```

Requirements

This example app requires:

- MATLAB R2020a or later.
- Data Acquisition Toolbox (supported on Windows® only).
- Stateflow (for creating and editing charts only).
- A supported DAQ device or sound card. For example, any National Instruments or Measurement Computing device that supports analog input **Voltage** or **IEPE** measurements and background acquisition.
- Corresponding hardware support package and device drivers.

App States and the Stateflow Chart

When creating an app that has complex logic, consider the various states that correspond to the operating modes of the app. You can use a Stateflow chart to visualize and organize these app states. Use transitions between states to implement the control logic of your app. For example, the file `AnalogTriggerAppLogic.sfx` defines the Stateflow chart that controls the logic for this app. The chart can transition between states based on an action in the app UI or on a data-driven condition. For example, if you click the **Start** button, the chart transitions from the **Configuration** state to the **Acquisition** state. If the value of the signal crosses the specified trigger level, the chart transitions from the **LookingForTrigger** state to the **CapturingData** state.

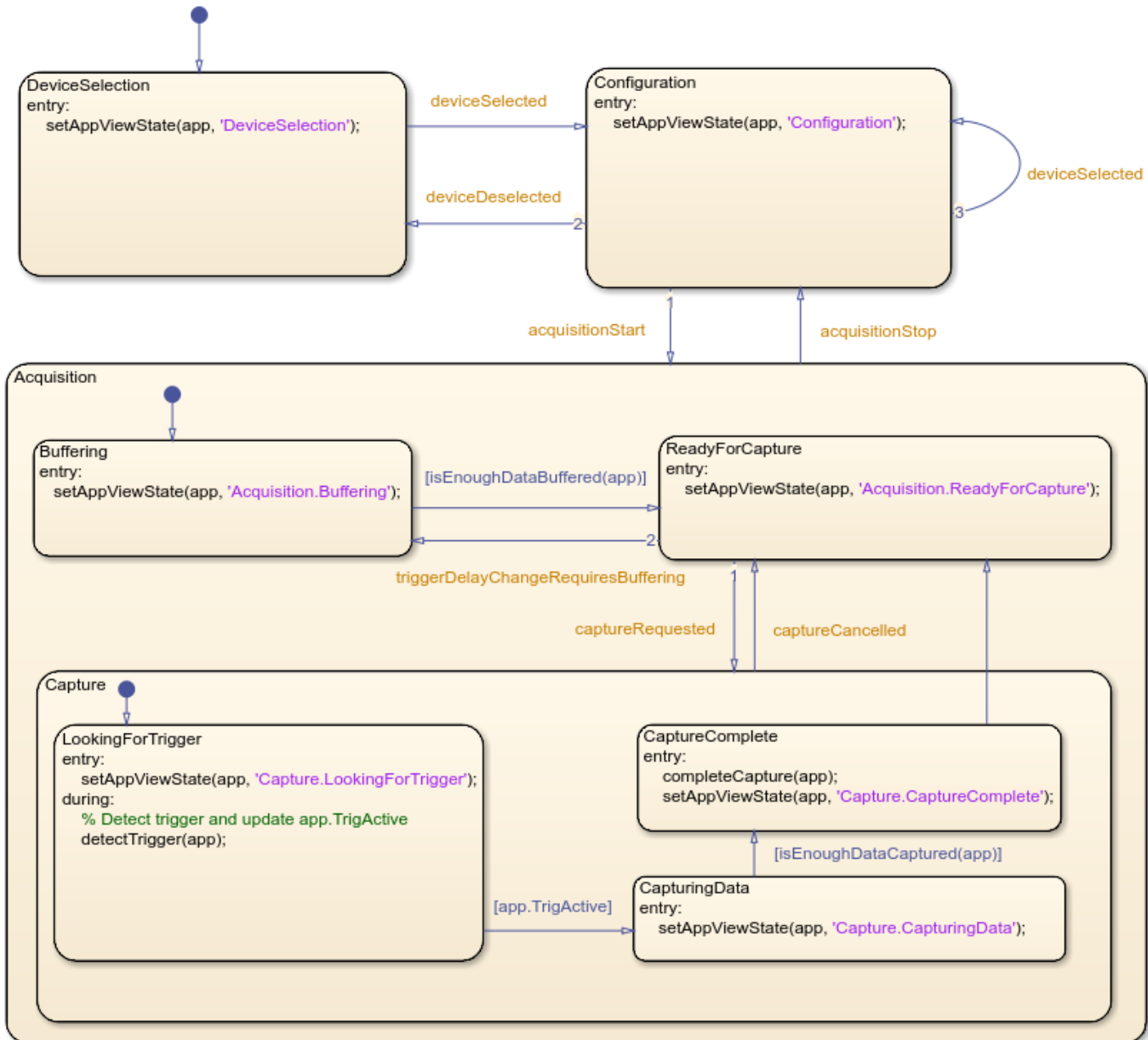

Integrating the App with the Stateflow Chart

To establish a bidirectional connection between the MATLAB app and the Stateflow chart, in the startupFcn function of your app, create a chart object and store its handle in an app property.

```
app.Chart = AnalogTriggerAppLogic('app',app);
```

The app uses this handle to trigger state transitions in the chart. For example, when you click **Start**, the StartButtonPushed app callback function calls the acquisitionStart input event for the chart. This event triggers the transition from the Configuration state to the Acquisition state.

To evaluate transition conditions that are not events in the chart, the app calls the step function for the chart object. For example, while acquiring data from the device, the dataAvailable_Callback

app function periodically calls the `step` function. When the trigger condition is detected, the chart transitions from the `LookingForTrigger` State to the `CapturingData` state.

In the Stateflow chart, store the app object handle as chart local data. To share public properties and call public functions of the app, the Stateflow chart can use this handle in state actions, transition conditions, or transition actions.

See Also

Chart

More About

- “Design Human-Machine Interface Logic by Using Stateflow Charts” on page 35-24

Semantic Rules Summary

Summary of Chart Semantic Rules

In this section...
“Enter a Chart” on page A-2
“Execute an Active Chart” on page A-2
“Enter a State” on page A-2
“Execute an Active State” on page A-3
“Exit an Active State” on page A-3
“Execute a Set of Flow Charts” on page A-3
“Execute an Event Broadcast” on page A-4

Enter a Chart

The set of default flow paths execute (see “Execute a Set of Flow Charts” on page A-3). If this action does not cause a state entry and the chart has parallel decomposition, then each parallel state becomes active (see “Enter a State” on page A-2).

If executing the default flow paths does not cause state entry, a state inconsistency error occurs.

Execute an Active Chart

If the chart has no states, each execution is equivalent to initializing a chart. Otherwise, the active children execute. Parallel states execute in the same order that they become active.

Enter a State

- 1 If the parent of the state is not active, perform steps 1 through 4 for the parent.
- 2 If this state is a parallel state, check that all siblings with a higher (that is, earlier) entry order are active. If not, perform steps 1 through 5 for these states first.

Parallel (AND) states are ordered for entry based on whether you use explicit ordering (default) or implicit ordering. For details, see “Explicit Ordering of Parallel States” on page 3-58 and “Implicit Ordering of Parallel States” on page 3-59.

- 3 Mark the state active.
- 4 Perform any entry actions.
- 5 Enter children, if needed:
 - a If the state contains a history junction and there was an active child of this state at some point after the most recent chart initialization, perform the entry actions for that child. Otherwise, execute the default flow paths for the state.
 - b If this state has children that are parallel states (parallel decomposition), perform entry steps 1 through 5 for each state according to its entry order.
 - c If this state has only one child substate, the substate becomes active when the parent becomes active, regardless of whether a default transition is present. Entering the parent state automatically makes the substate active. The presence of any inner transition has no effect on determining the active substate.

- 6 If this state is a parallel state, perform all entry steps for the sibling state next in entry order if one exists.
- 7 If the transition path parent is not the same as the parent of the current state, perform entry steps 6 and 7 for the immediate parent of this state.

Execute an Active State

- 1 The set of outer flow charts execute (see “Execute a Set of Flow Charts” on page A-3). If this action causes a state transition, execution stops. (Note that this step never occurs for parallel states.)
- 2 During actions and valid on-event actions are performed.
- 3 The set of inner flow charts execute. If this action does not cause a state transition, the active children execute, starting at step 1. Parallel states execute in the same order that they become active.

Exit an Active State

- 1 If this is a parallel state, make sure that all sibling states that became active after this state have already become inactive. Otherwise, perform all exiting steps on those sibling states.
- 2 If there are any active children, perform the exit steps on these states in the reverse order that they became active.
- 3 Perform any exit actions.
- 4 Mark the state as inactive.

Execute a Set of Flow Charts

Flow charts execute by starting at step 1 below with a set of starting transitions. The starting transitions for inner flow charts are all transition segments that originate on the respective state and reside entirely within that state. The starting transitions for outer flow charts are all transition segments that originate on the respective state but reside at least partially outside that state. The starting transitions for default flow charts are all default transition segments that have starting points with the same parent:

- 1 Ordering of a set of transition segments occurs.
- 2 While there are remaining segments to test, testing a segment for validity occurs. If the segment is invalid, testing of the next segment occurs. If the segment is valid, execution depends on the destination:

States

- a Testing of transition segments stops and a transition path forms by backing up and including the transition segment from each preceding junction until the respective starting transition.
- b The states that are the immediate children of the parent of the transition path exit (see “Exit an Active State” on page A-3).
- c The transition action from the final transition path executes.
- d The destination state becomes active (see “Enter a State” on page A-2).

Junctions with no outgoing transition segments

Testing stops without any state exits or entries.

Junctions with outgoing transition segments

Step 1 is repeated with the set of outgoing segments from the junction.

- 3 After testing all outgoing transition segments at a junction, backtrack the incoming transition segment that brought you to the junction and continue at step 2, starting with the next transition segment after the backtrack segment. The set of flow charts finishes execution when testing of all starting transitions is complete.

Execute an Event Broadcast

Output edge-trigger event execution is equivalent to changing the value of an output data value. All other events have the following execution:

- 1 If the *receiver* of the event is active, then it executes (see “Execute an Active Chart” on page A-2 and “Execute an Active State” on page A-3). (The event *receiver* is the parent of the event unless a direct event broadcast occurs using the `send()` function.)

If the receiver of the event is not active, nothing happens.

- 2 After broadcasting the event, the broadcaster performs early return logic based on the type of action statement that caused the event.

Action Type	Early Return Logic
State Entry	If the state is no longer active at the end of the event broadcast, any remaining steps in entering a state do not occur.
State Exit	If the state is no longer active at the end of the event broadcast, any remaining exit actions and steps in state transitioning do not occur.
State During	If the state is no longer active at the end of the event broadcast, any remaining steps in executing an active state do not occur.
Condition	If the origin state of the inner or outer flow chart or parent state of the default flow chart is no longer active at the end of the event broadcast, the remaining steps in the execution of the set of flow charts do not occur.
Transition	If the parent of the transition path is not active or if that parent has an active child, the remaining transition actions and state entry do not occur.

Semantic Examples

Categories of Semantic Examples

The following examples show the detailed semantics (behavior) of Stateflow charts.

“Transition Between Exclusive States” on page B-4

- “Transition from State to State with Events” on page B-4
- “Transition from a Substate to a Substate with Events” on page B-7

“Control Chart Execution by Using Condition Actions” on page B-9

- “Condition Action Behavior” on page B-9
- “Condition and Transition Action Behavior” on page B-9
- “Create Condition Actions Using a For-Loop” on page B-10
- “Broadcast Events to Parallel (AND) States Using Condition Actions” on page B-11
- “Avoid Cyclic Behavior” on page B-12

“Control Chart Execution by Using Default Transitions” on page B-14

- “Default Transition in Exclusive (OR) Decomposition” on page B-14
- “Default Transition to a Junction” on page B-14
- “Default Transition and a History Junction” on page B-15
- “Labeled Default Transitions” on page B-16

“Process Events in States Containing Inner Transitions” on page B-18

- “Process One Event in an Exclusive (OR) State” on page B-18
- “Process a Second Event in an Exclusive (OR) State” on page B-18
- “Process a Third Event in an Exclusive (OR) State” on page B-19
- “Process the First Event with an Inner Transition to a Connective Junction” on page B-20
- “Process a Second Event with an Inner Transition to a Connective Junction” on page B-21
- “Inner Transition to a History Junction” on page B-21

“Represent Multiple Paths by Using Connective Junctions” on page B-23

- “If-Then-Else Decision Construct” on page B-23
- “Self-Loop Transition” on page B-24
- “For-Loop Construct” on page B-25
- “Flow Chart Notation” on page B-26
- “Transition from a Common Source to Multiple Destinations” on page B-28
- “Transition from Multiple Sources to a Common Destination” on page B-29
- “Transition from a Source to a Destination Based on a Common Event” on page B-30

“Control Chart Execution by Using Event Actions in a Superstate” on page B-32

“Undirected Broadcast Events in Parallel States” on page B-33

- “Broadcast Events in State Actions” on page B-33

- “Broadcast Events in Transition Actions” on page B-34
- “Broadcast Events in Condition Actions” on page B-36

“Broadcast Local Events in Parallel States” on page B-39

- “Directed Event Broadcast Using Send” on page B-39
- “Directed Event Broadcast Using Qualified Event Name” on page B-40

Transition Between Exclusive States

Label Format for a State-to-State Transition

The following example shows the general label format for a transition entering a state.

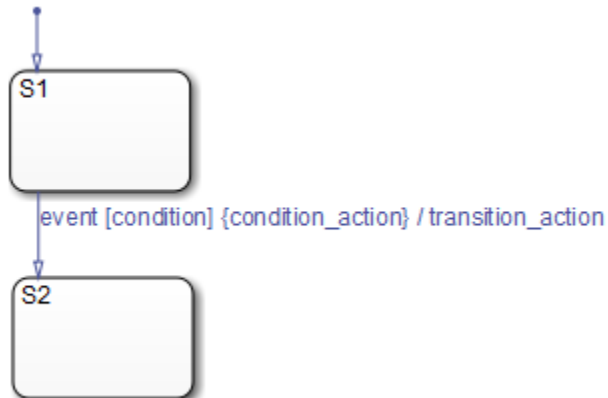

A chart executes this transition as follows:

- 1 When an event occurs, state S1 checks for an outgoing transition with a matching event specified.
- 2 If a transition with a matching event is found, the condition for that transition ([condition]) is evaluated.
- 3 If the condition is true, condition_action is executed.
- 4 If there is a valid transition to the destination state, the transition is taken.
- 5 State S1 is exited.
- 6 The transition_action is executed when the transition is taken.
- 7 State S2 is entered.

Transition from State to State with Events

The following example shows the behavior of a simple transition focusing on the implications of whether states are active or inactive.

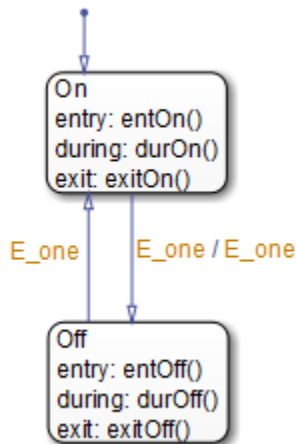

Process a First Event

Initially, the chart is asleep. State `On` and state `Off` are OR states. State `On` is active. Event `E_one` occurs and awakens the chart, which processes the event from the root down through the hierarchy:

- 1 The chart root checks to see if there is a valid transition as a result of `E_one`. A valid transition from state `On` to state `Off` is detected.
- 2 State `On` exit actions (`exitOn()`) execute and complete.
- 3 State `On` is marked inactive.
- 4 The event `E_one` is broadcast as the transition action.

This second event `E_one` is processed, but because neither state is active, it has no effect. If the second broadcast of `E_one` resulted in a valid transition, it would preempt the processing of the first broadcast of `E_one`. See “Early Return Logic” on page 3-52.

- 5 State `Off` is marked active.
- 6 State `Off` entry actions (`entOff()`) execute and complete.
- 7 The chart goes back to sleep.

This sequence completes the execution of the Stateflow chart associated with event `E_one` when state `On` is initially active.

Process a Second Event

Using the same example, what happens when the next event, `E_one`, occurs while state `Off` is active?

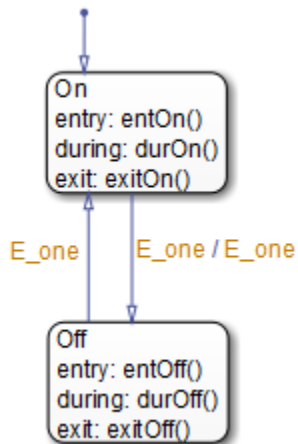

Initially, the chart is asleep. State **Off** is active. Event `E_one` occurs and awakens the chart, which processes the event from the root down through the hierarchy:

- 1 The chart root checks to see if there is a valid transition as a result of `E_one`.
A valid transition from state **Off** to state **On** is detected.
- 2 State **Off** exit actions (`exitOff()`) execute and complete.
- 3 State **Off** is marked inactive.
- 4 State **On** is marked active.
- 5 State **On** entry actions (`entOn()`) execute and complete.
- 6 The chart goes back to sleep.

This sequence completes the execution of the Stateflow chart associated with the second event `E_one` when state **Off** is initially active.

Process a Third Event

Using the same example, what happens when a third event, `E_two`, occurs?

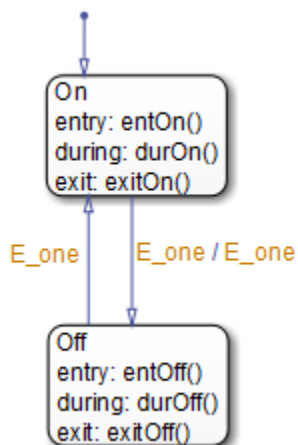

Notice that the event `E_two` is not used explicitly in this example. However, its occurrence (or the occurrence of any event) does result in behavior. Initially, the chart is asleep and state **On** is active.

- 1 Event `E_two` occurs and awakens the chart.

Event `E_two` is processed from the root of the chart down through the hierarchy of the chart.

- 2 The chart root checks to see if there is a valid transition as a result of `E_two`. There is none.
- 3 State `On` during actions (`durOn()`) execute and complete.
- 4 The chart goes back to sleep.

This sequence completes the execution of the Stateflow chart associated with event `E_two` when state `On` is initially active.

Tip Avoid using undirected local event broadcasts. Undirected local event broadcasts can cause unwanted recursive behavior in your chart. Instead, send local events by using directed broadcasts. For more information, see “Broadcast Local Events to Synchronize Parallel States” on page 13-37.

You can set the diagnostic level for detecting undirected local event broadcasts. In the Configuration Parameters dialog box, open the **Diagnostics > Stateflow** pane and set the **Undirected event broadcasts** parameter to none, warning, or error. The default setting is warning.

Transition from a Substate to a Substate with Events

This example shows the behavior of a transition from an OR substate to an OR substate.

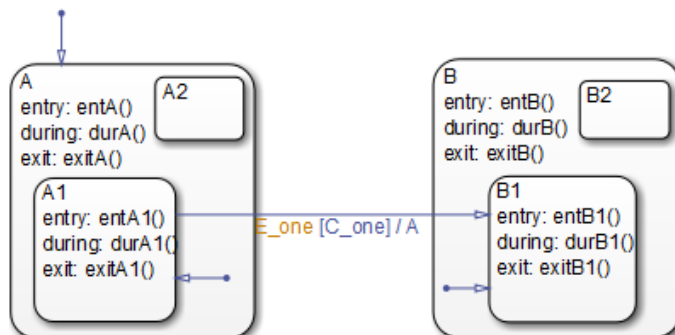

Initially, the chart is asleep. State `A.A1` is active. Condition `C_one` is true. Event `E_one` occurs and awakens the chart, which processes the event from the root down through the hierarchy:

- 1 The chart root checks to see if there is a valid transition as a result of `E_one`. There is a valid transition from state `A.A1` to state `B.B1`. (Condition `C_one` is true.)
- 2 State `A` during actions (`durA()`) execute and complete.
- 3 State `A.A1` exit actions (`exitA1()`) execute and complete.
- 4 State `A.A1` is marked inactive.
- 5 State `A` exit actions (`exitA()`) execute and complete.
- 6 State `A` is marked inactive.
- 7 The transition action, `A`, is executed and completed.
- 8 State `B` is marked active.
- 9 State `B` entry actions (`entB()`) execute and complete.

- 10** State B.B1 is marked active.
- 11** State B.B1 entry actions (`entB1()`) execute and complete.
- 12** The chart goes back to sleep.

This sequence completes the execution of this Stateflow chart associated with event `E_one`.

Control Chart Execution by Using Condition Actions

Condition Action Behavior

This example shows the behavior of a simple condition action in a transition path with multiple segments. The chart uses implicit ordering of outgoing transitions (see “Implicit Ordering” on page 3-39).

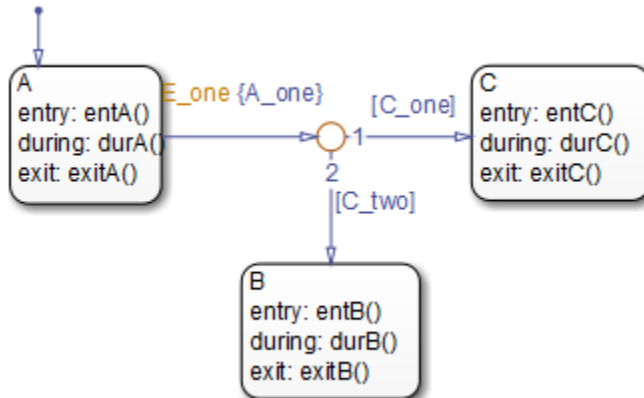

Initially, the chart is asleep. State A is active. Conditions C_one and C_two are false. Event E_one occurs and awakens the chart, which processes the event from the root down through the hierarchy:

- 1 The chart root checks to see if there is a valid transition as a result of E_one. A valid transition segment from state A to a connective junction is detected. The condition action A_one is detected on the valid transition segment and is immediately executed and completed. State A is still active.
- 2 Because the conditions on the transition segments to possible destinations are false, none of the complete transitions is valid.
- 3 State A during actions (durA()) execute and complete.

State A remains active.

- 4 The chart goes back to sleep.

This sequence completes the execution of this Stateflow chart associated with event E_one when state A is initially active.

Condition and Transition Action Behavior

This example shows the behavior of a simple condition and transition action specified on a transition from one exclusive (OR) state to another.

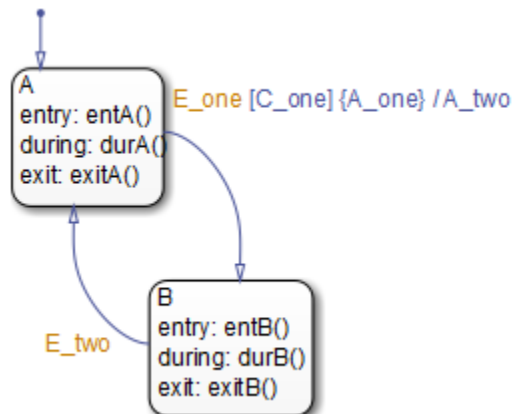

Initially, the chart is asleep. State A is active. Condition C_one is true. Event E_one occurs and awakens the chart, which processes the event from the root down through the hierarchy:

- 1 The chart root checks to see if there is a valid transition as a result of E_one. A valid transition from state A to state B is detected. The condition C_one is true. The condition action A_one is detected on the valid transition and is immediately executed and completed. State A is still active.
- 2 State A exit actions (ExitA()) execute and complete.
- 3 State A is marked inactive.
- 4 The transition action A_two is executed and completed.
- 5 State B is marked active.
- 6 State B entry actions (entB()) execute and complete.
- 7 The chart goes back to sleep.

This sequence completes the execution of this Stateflow chart associated with event E_one when state A is initially active.

Create Condition Actions Using a For-Loop

Condition actions and connective junctions are used to design a for loop construct. This example shows the use of a condition action and connective junction to create a for loop construct. The chart uses implicit ordering of outgoing transitions (see “Implicit Ordering” on page 3-39).

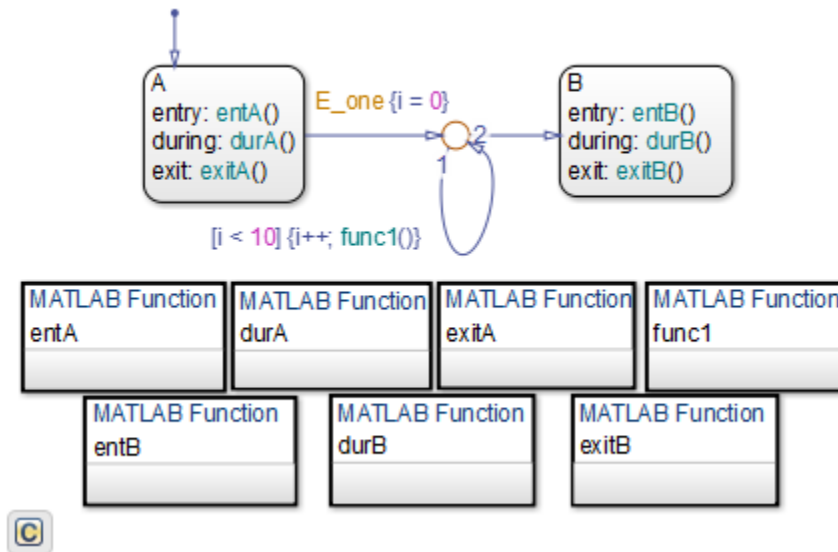

See “For-Loop Construct” on page B-25 to see the behavior of this example.

Broadcast Events to Parallel (AND) States Using Condition Actions

This example shows how to use condition actions to broadcast events immediately to parallel (AND) states. The chart uses implicit ordering of parallel states (see “Implicit Ordering of Parallel States” on page 3-59).

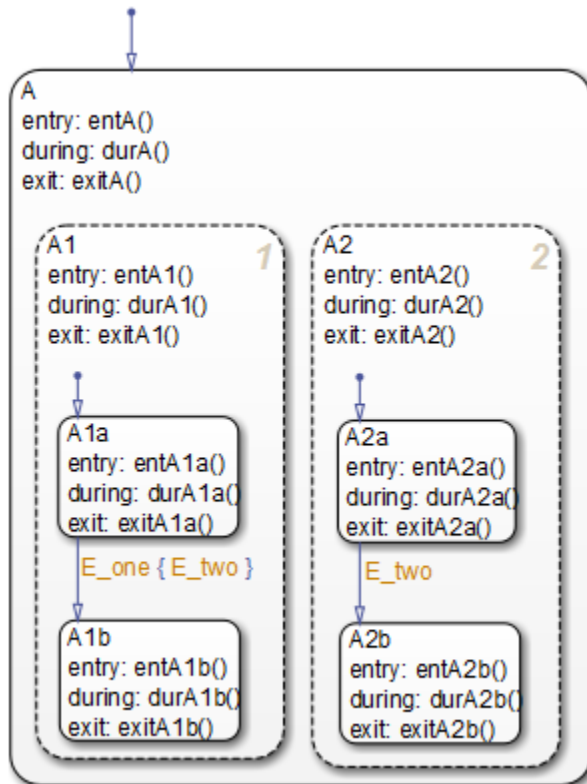

See “Broadcast Events in Condition Actions” on page B-36 to see the behavior of this example.

Tip Avoid using undirected local event broadcasts. Undirected local event broadcasts can cause unwanted recursive behavior in your chart. Instead, send local events by using directed broadcasts. For more information, see “Broadcast Local Events to Synchronize Parallel States” on page 13-37.

You can set the diagnostic level for detecting undirected local event broadcasts. In the Configuration Parameters dialog box, open the **Diagnostics > Stateflow** pane and set the **Undirected event broadcasts** parameter to none, warning, or error. The default setting is warning.

Avoid Cyclic Behavior

This example shows a notation to avoid when using event broadcasts as condition actions because the semantics results in cyclic behavior.

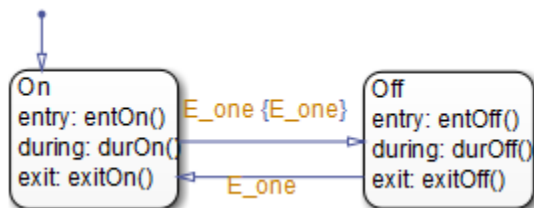

Initially, the chart is asleep. State On is active. Event E_one occurs and awakens the chart, which processes the event from the root down through the hierarchy:

- 1 The chart root checks to see if there is a valid transition as a result of E_one.
A valid transition from state On to state Off is detected.
- 2 The condition action on the transition broadcasts event E_one.
- 3 Event E_one is detected on the valid transition, which is immediately executed. State On is still active.
- 4 The broadcast of event E_one awakens the chart a second time.
- 5 Go to step 1.

Steps 1 through 5 continue to execute in a cyclical manner. The transition label indicating a trigger on the same event as the condition action broadcast event results in unrecoverable cyclic behavior. This sequence never completes when event E_one is broadcast and state On is active.

Tip Avoid using undirected local event broadcasts. Undirected local event broadcasts can cause unwanted recursive behavior in your chart. Instead, send local events by using directed broadcasts. For more information, see “Broadcast Local Events to Synchronize Parallel States” on page 13-37.

You can set the diagnostic level for detecting undirected local event broadcasts. In the Configuration Parameters dialog box, open the **Diagnostics > Stateflow** pane and set the **Undirected event broadcasts** parameter to none, warning, or error. The default setting is warning.

See Also

More About

- “Transition Action Types” on page 13-7
- “Broadcast Local Events to Synchronize Parallel States” on page 13-37
- “Supported Operations for Chart Data” on page 13-13

Control Chart Execution by Using Default Transitions

Default Transition in Exclusive (OR) Decomposition

This example shows a transition from an OR state to a superstate with exclusive (OR) decomposition, where a default transition to a substate is defined.

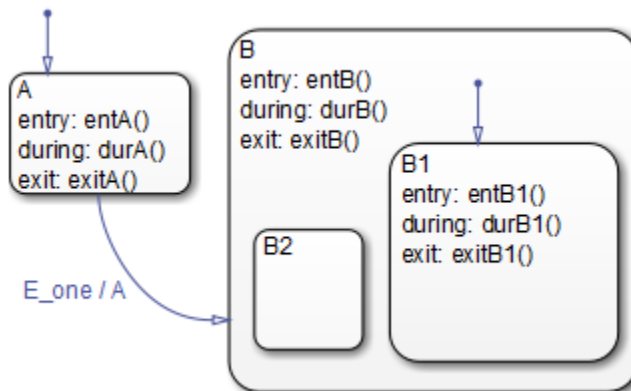

Initially, the chart is asleep. State A is active. Event `E_one` occurs and awakens the chart, which processes the event from the root down through the hierarchy:

- 1 The chart root checks to see if there is a valid transition as a result of `E_one`. There is a valid transition from state A to superstate B.
- 2 State A exit actions (`exitA()`) execute and complete.
- 3 State A is marked inactive.
- 4 The transition action, A, is executed and completed.
- 5 State B is marked active.
- 6 State B entry actions (`entB()`) execute and complete.
- 7 State B detects a valid default transition to state B.B1.
- 8 State B.B1 is marked active.
- 9 State B.B1 entry actions (`entB1()`) execute and complete.
- 10 The chart goes back to sleep.

This sequence completes the execution of this Stateflow chart associated with event `E_one` when state A is initially active.

Default Transition to a Junction

The following example shows the behavior of a default transition to a connective junction. The default transition to the junction is valid only when state B is first entered, not every time the chart wakes up.

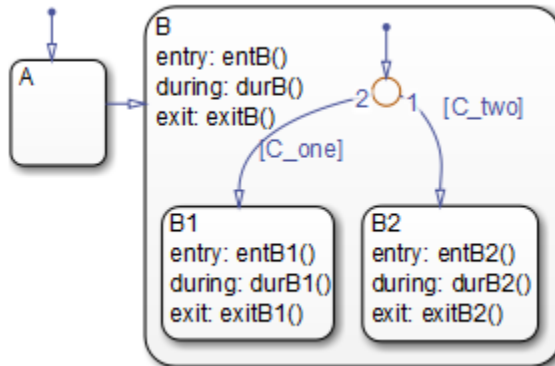

For this example, initially, the chart is asleep. State B.B1 is active. Condition [C_two] is true. An event occurs and awakens the chart, which processes the event from the root down through the hierarchy:

- 1 State B checks to see if there is a valid transition as a result of any event. There is none.
- 2 State B during actions (durB()) execute and complete.
- 3 State B1 checks to see if there is a valid transition as a result of any event. There is none.
- 4 State B1 during actions (durB1()) execute and complete.

This sequence completes the execution of this Stateflow chart associated with the occurrence of any event.

Default Transition and a History Junction

This example shows the behavior of a superstate with a default transition and a history junction. The chart uses implicit ordering of outgoing transitions (see “Implicit Ordering” on page 3-39).

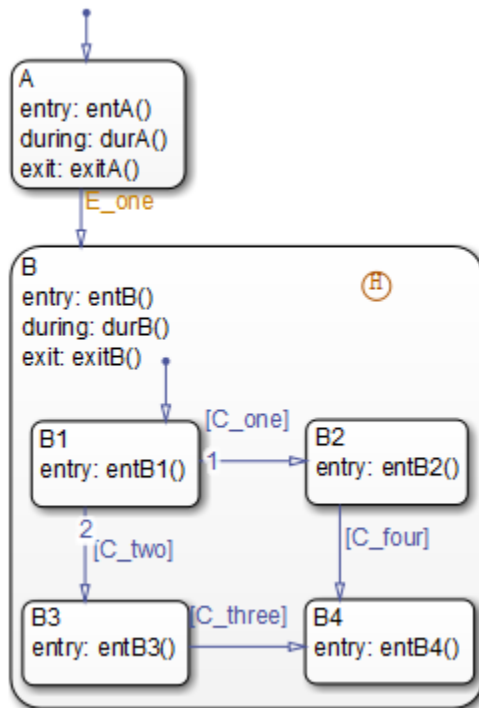

Initially, the chart is asleep. State A is active. A history junction records the fact that state B4 is the previously active substate of superstate B. Event E_one occurs and awakens the chart, which processes the event from the root down through the hierarchy:

- 1 The chart root checks to see if there is a valid transition as a result of E_one.
There is a valid transition from state A to superstate B.
- 2 State A exit actions (exitA()) execute and complete.
- 3 State A is marked inactive.
- 4 State B is marked active.
- 5 State B entry actions (entB()) execute and complete.
- 6 State B uses the history junction to determine the substate destination of the transition into the superstate.
The history junction indicates that substate B.B4 was the last active substate, which becomes the destination of the transition.
- 7 State B.B4 is marked active.
- 8 State B.B4 entry actions (entB4()) execute and complete.
- 9 The chart goes back to sleep.

This sequence completes the execution of this Stateflow chart associated with event E_one.

Labeled Default Transitions

This example shows the use of a default transition with a label. The chart uses implicit ordering of outgoing transitions (see “Implicit Ordering” on page 3-39).

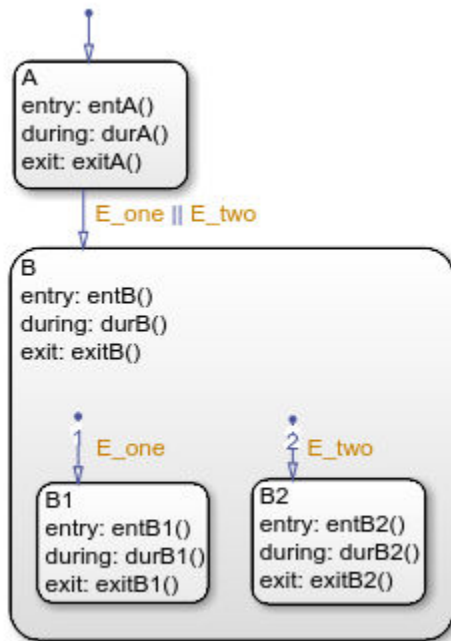

Initially, the chart is asleep. State A is active. Event `E_one` occurs and awakens the chart, which processes the event from the root down through the hierarchy:

- 1 The chart root checks to see if there is a valid transition as a result of `E_one`.
There is a valid transition from state A to superstate B. The transition is valid if event `E_one` or `E_two` occurs.
- 2 State A exit actions execute and complete (`exitA()`).
- 3 State A is marked inactive.
- 4 State B is marked active.
- 5 State B entry actions execute and complete (`entB()`).
- 6 State B detects a valid default transition to state B.B1. The default transition is valid as a result of `E_one`.
- 7 State B.B1 is marked active.
- 8 State B.B1 entry actions execute and complete (`entB1()`).
- 9 The chart goes back to sleep.

This sequence completes the execution of this Stateflow chart associated with event `E_one` when state A is initially active.

Process Events in States Containing Inner Transitions

Process Events with an Inner Transition in an Exclusive (OR) State

This example shows what happens when processing three events using an inner transition in an exclusive (OR) state.

Process One Event in an Exclusive (OR) State

This example shows the behavior of an inner transition. The chart uses implicit ordering of outgoing transitions (see “Implicit Ordering” on page 3-39).

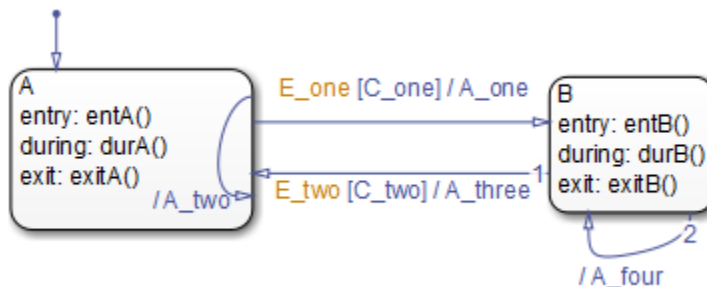

Initially, the chart is asleep. State A is active. Condition [C_one] is false. Event E_one occurs and awakens the chart, which processes the event from the root down through the hierarchy:

- 1 The chart root checks to see if there is a valid transition as a result of E_one. A potentially valid transition from state A to state B is detected. However, the transition is not valid, because [C_one] is false.
- 2 State A during actions (durA()) execute and complete.
- 3 State A checks its children for a valid transition and detects a valid inner transition.
- 4 State A remains active. The inner transition action A_two is executed and completed. Because it is an inner transition, state A's exit and entry actions are not executed.
- 5 The chart goes back to sleep.

This sequence completes the execution of this Stateflow chart associated with event E_one.

Process a Second Event in an Exclusive (OR) State

Using the previous example, this example shows what happens when a second event E_one occurs. The chart uses implicit ordering of outgoing transitions (see “Implicit Ordering” on page 3-39).

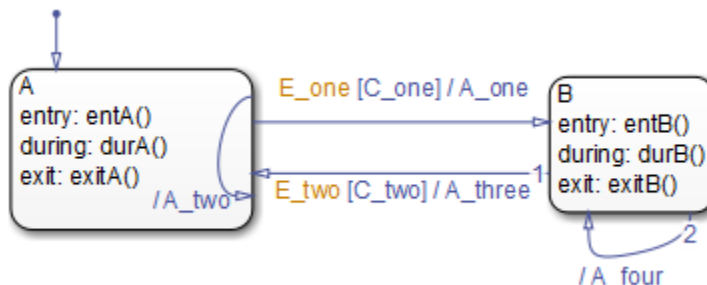

Initially, the chart is asleep. State A is still active. Condition `[C_one]` is true. Event `E_one` occurs and awakens the chart, which processes the event from the root down through the hierarchy:

- 1 The chart root checks to see if there is a valid transition as a result of `E_one`.

The transition from state A to state B is now valid because `[C_one]` is true.

- 2 State A exit actions (`exitA()`) execute and complete.
- 3 State A is marked inactive.
- 4 The transition action `A_one` is executed and completed.
- 5 State B is marked active.
- 6 State B entry actions (`entB()`) execute and complete.
- 7 The chart goes back to sleep.

This sequence completes the execution of this Stateflow chart associated with event `E_one`.

Process a Third Event in an Exclusive (OR) State

Using the previous example, this example shows what happens when a third event, `E_two`, occurs. The chart uses implicit ordering of outgoing transitions (see “Implicit Ordering” on page 3-39).

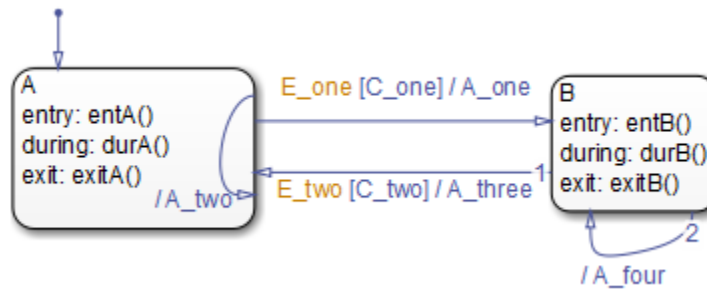

Initially, the chart is asleep. State B is now active. Condition `[C_two]` is false. Event `E_two` occurs and awakens the chart, which processes the event from the root down through the hierarchy:

- 1 The chart root checks to see if there is a valid transition as a result of `E_two`.

A potentially valid transition from state B to state A is detected. The transition is not valid because `[C_two]` is false. However, active state B has a valid self-loop transition.

- 2 State B exit actions (`exitB()`) execute and complete.
- 3 State B is marked inactive.
- 4 The self-loop transition action, `A_four`, executes and completes.
- 5 State B is marked active.
- 6 State B entry actions (`entB()`) execute and complete.
- 7 The chart goes back to sleep.

This sequence completes the execution of this Stateflow chart associated with event `E_two`. This example shows the difference in behavior between inner and self-loop transitions.

Process Events with an Inner Transition to a Connective Junction

This example shows the behavior of handling repeated events using an inner transition to a connective junction.

Process the First Event with an Inner Transition to a Connective Junction

This example shows the behavior of an inner transition to a connective junction for the first event. The chart uses implicit ordering of outgoing transitions (see “Implicit Ordering” on page 3-39).

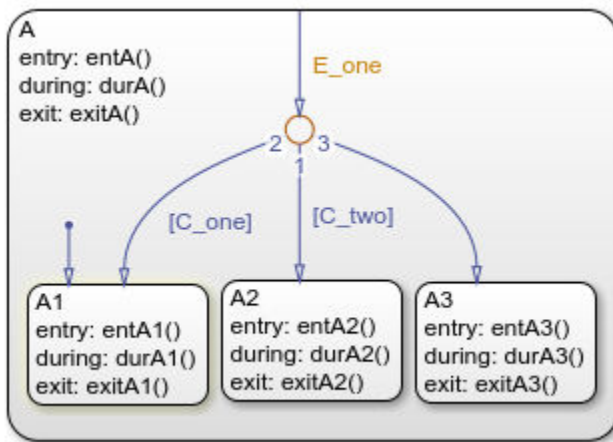

Initially, the chart is asleep. State A1 is active. Condition [C_two] is true. Event E_one occurs and awakens the chart, which processes the event from the root down through the hierarchy:

- 1 The chart root checks to see if there is a valid transition at the root level as a result of E_one. There is no valid transition.
- 2 State A during actions (durA()) execute and complete.
- 3 State A checks itself for valid transitions and detects that there is a valid inner transition to a connective junction.

The conditions are evaluated to determine whether one of the transitions is valid. Because implicit ordering applies, the segments labeled with a condition are evaluated before the unlabeled segment. The evaluation starts from a 12 o'clock position on the junction and progresses in a clockwise manner. Because [C_two] is true, the inner transition to the junction and then to state A.A2 is valid.

- 4 State A.A1 exit actions (exitA1()) execute and complete.
- 5 State A.A1 is marked inactive.
- 6 State A.A2 is marked active.
- 7 State A.A2 entry actions (entA2()) execute and complete.
- 8 The chart goes back to sleep.

This sequence completes the execution of this Stateflow chart associated with event E_one when state A1 is active and condition [C_two] is true.

Process a Second Event with an Inner Transition to a Connective Junction

Continuing the previous example, this example shows the behavior of an inner transition to a junction when a second event `E_one` occurs. The chart uses implicit ordering of outgoing transitions (see “Implicit Ordering” on page 3-39).

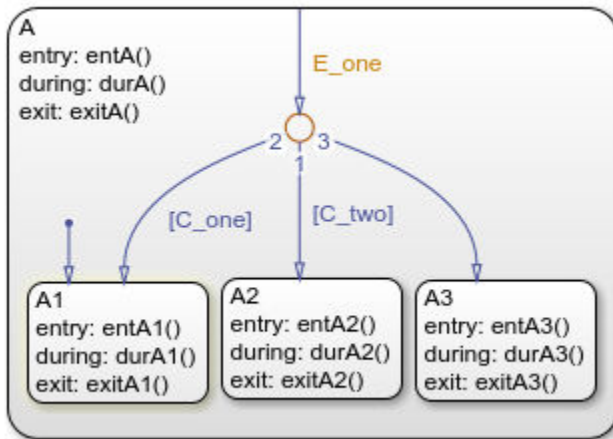

Initially, the chart is asleep. State A2 is active. Condition `[C_two]` is true. Event `E_one` occurs and awakens the chart, which processes the event from the root down through the hierarchy:

- 1 The chart root checks to see if there is a valid transition at the root level as a result of `E_one`. There is no valid transition.
- 2 State A during actions (`durA()`) execute and complete.
- 3 State A checks itself for valid transitions and detects a valid inner transition to a connective junction.

The conditions are evaluated to determine whether one of the transitions is valid. Because implicit ordering applies, the segments labeled with a condition are evaluated before the unlabeled segment. The evaluation starts from a 12 o'clock position on the junction and progresses in a clockwise manner. Because `[C_two]` is true, the inner transition to the junction and then to state A.A2 is valid.

- 4 State A.A2 exit actions (`exitA2()`) execute and complete.
- 5 State A.A2 is marked inactive.
- 6 State A.A2 is marked active.
- 7 State A.A2 entry actions (`entA2()`) execute and complete.
- 8 The chart goes back to sleep.

This sequence completes the execution of this Stateflow chart associated with event `E_one` when state A2 is active and condition `[C_two]` is true. For a state with a valid inner transition, an active substate can be exited and reentered immediately.

Inner Transition to a History Junction

This example shows the behavior of an inner transition to a history junction.

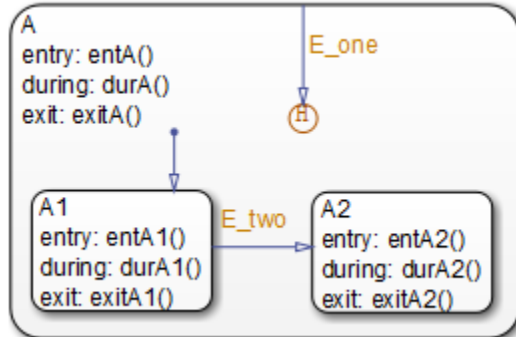

Initially, the chart is asleep. State A.A1 is active. History information exists because superstate A is active. Event E_one occurs and awakens the chart, which processes the event from the root down through the hierarchy:

- 1 The chart root checks to see if there is a valid transition as a result of E_one. There is no valid transition.
- 2 State A during actions execute and complete.
- 3 State A checks itself for valid transitions and detects that there is a valid inner transition to a history junction. Based on the history information, the last active state, A.A1, is the destination state.
- 4 State A.A1 exit actions execute and complete.
- 5 State A.A1 is marked inactive.
- 6 State A.A1 is marked active.
- 7 State A.A1 entry actions execute and complete.
- 8 The chart goes back to sleep.

This sequence completes the execution of this Stateflow chart associated with event E_one when there is an inner transition to a history junction and state A.A1 is active. For a state with a valid inner transition, an active substate can be exited and reentered immediately.

Represent Multiple Paths by Using Connective Junctions

Label Format for Transition Segments

The label format for a transition segment entering a junction is the same as for transitions entering states, as shown in the following example. The chart uses implicit ordering of outgoing transitions (see “Implicit Ordering” on page 3-39).

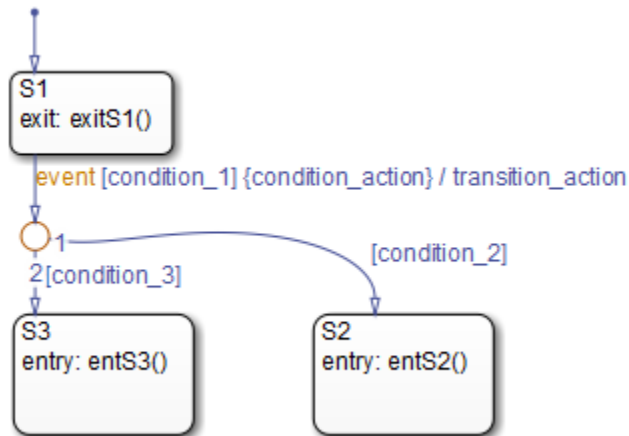

Execution of a transition in this example occurs as follows:

- 1 When an event occurs, state S1 is checked for an outgoing transition with a matching event specified.
- 2 If a transition with a matching event is found, the transition condition for that transition (in brackets) is evaluated.
- 3 If `condition_1` evaluates to true, the condition action `condition_action` (in braces) is executed.
- 4 The outgoing transitions from the junction are checked for a valid transition. Since `condition_2` is true, a valid state-to-state transition from S1 to S2 exists.
- 5 State S1 exit actions execute and complete.
- 6 State S1 is marked inactive.
- 7 The transition action `transition_action` executes and completes.
- 8 The completed state-to-state transition from S1 to S2 occurs.
- 9 State S2 is marked active.
- 10 State S2 entry actions execute and complete.

If-Then-Else Decision Construct

This example shows the behavior of an if-then-else decision construct. The chart uses implicit ordering of outgoing transitions (see “Implicit Ordering” on page 3-39).

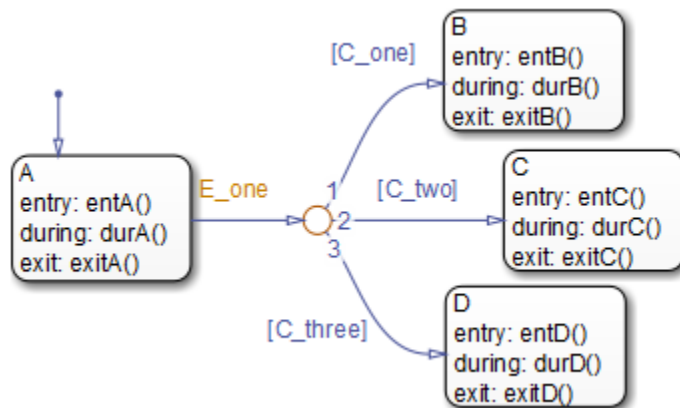

Initially, the chart is asleep. State A is active. Condition [C_two] is true. Event E_one occurs and awakens the chart, which processes the event from the root down through the hierarchy:

- 1 The chart root checks to see if there is a valid transition as a result of E_one.

A valid transition segment from state A to the connective junction exists. Because implicit ordering applies, the transition segments beginning from a 12 o'clock position on the connective junction are evaluated for validity. The first transition segment, labeled with condition [C_one], is not valid. The next transition segment, labeled with the condition [C_two], is valid. The complete transition from state A to state C is valid.

- 2 State A exit actions (exitA()) execute and complete.
- 3 State A is marked inactive.
- 4 State C is marked active.
- 5 State C entry actions (entC()) execute and complete.
- 6 The chart goes back to sleep.

This sequence completes the execution of this Stateflow chart associated with event E_one.

Self-Loop Transition

This example shows the behavior of a self-loop transition using a connective junction. The chart uses implicit ordering of outgoing transitions (see "Implicit Ordering" on page 3-39).

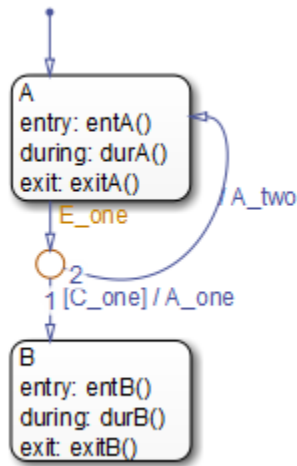

Initially, the chart is asleep. State A is active. Condition [C_one] is false. Event E_one occurs and awakens the chart, which processes the event from the root down through the hierarchy:

- 1 The chart root checks to see if there is a valid transition as a result of E_one. A valid transition segment from state A to the connective junction exists. Because implicit ordering applies, the transition segment labeled with a condition is evaluated for validity. Because the condition [C_one] is not valid, the complete transition from state A to state B is not valid. The transition segment from the connective junction back to state A is valid.
- 2 State A exit actions (exitA()) execute and complete.
- 3 State A is marked inactive.
- 4 The transition action A_two is executed and completed.
- 5 State A is marked active.
- 6 State A entry actions (entA()) execute and complete.
- 7 The chart goes back to sleep.

This sequence completes the execution of this Stateflow chart associated with event E_one.

For-Loop Construct

This example shows the behavior of a for loop using a connective junction. The chart uses implicit ordering of outgoing transitions (see “Implicit Ordering” on page 3-39).

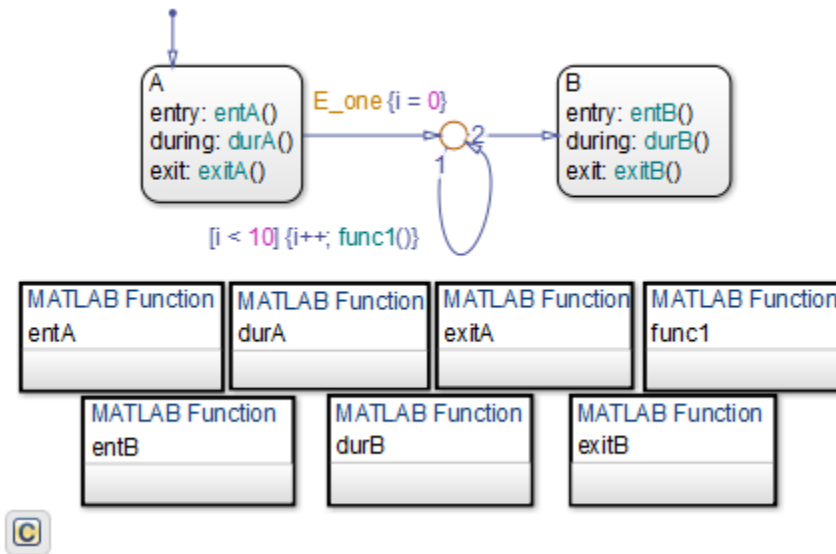

Initially, the chart is asleep. State A is active. Event `E_one` occurs and awakens the chart, which processes the event from the root down through the hierarchy:

- 1 The chart root checks to see if there is a valid transition as a result of `E_one`. There is a valid transition segment from state A to the connective junction. The transition segment condition action, `i = 0`, executes and completes. Of the two transition segments leaving the connective junction, the transition segment that is a self-loop back to the connective junction evaluates next for validity. That segment takes priority in evaluation because it has a condition, whereas the other segment is unlabeled. This evaluation behavior reflects implicit ordering of outgoing transitions in the chart.
- 2 The condition `[i < 10]` evaluates as true. The condition actions `i++` and a call to `func1` execute and complete until the condition becomes false. Because a connective junction is not a final destination, the transition destination is still unknown.
- 3 The unconditional segment to state B is now valid. The complete transition from state A to state B is valid.
- 4 State A exit actions (`exitA()`) execute and complete.
- 5 State A is marked inactive.
- 6 State B is marked active.
- 7 State B entry actions (`entB()`) execute and complete.
- 8 The chart goes back to sleep.

This sequence completes the execution of this chart associated with event `E_one`.

Flow Chart Notation

This example shows the behavior of a Stateflow chart that uses flow chart notation. The chart uses implicit ordering of outgoing transitions (see “Implicit Ordering” on page 3-39).

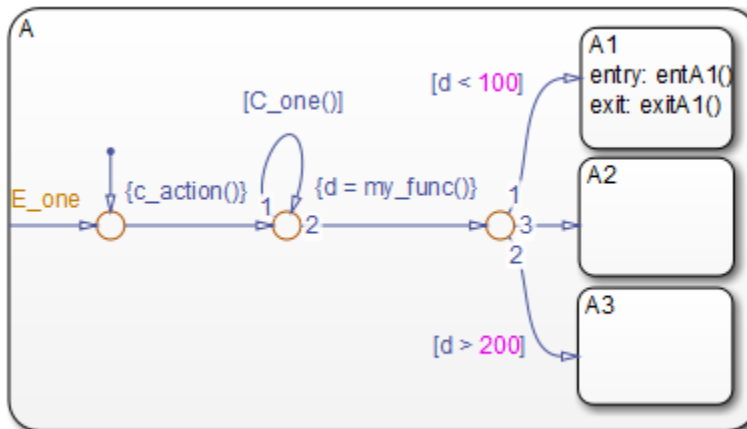

Initially, the chart is asleep. State A.A1 is active. The condition `[C_one()]` is initially true. Event `E_one` occurs and awakens the chart, which processes the event from the root down through the hierarchy:

- 1 The chart root checks to see if there is a valid transition as a result of `E_one`. There is no valid transition.
- 2 State A checks itself for valid transitions and detects a valid inner transition to a connective junction.
- 3 The next possible segments of the transition are evaluated. Only one outgoing transition exists, and it has a condition action defined. The condition action executes and completes.
- 4 The next possible segments are evaluated. Two outgoing transitions exist: a conditional self-loop transition and an unconditional transition segment. Because implicit ordering applies, the conditional transition segment takes precedence. Since the condition `[C_one()]` is true, the self-loop transition is taken. Since a final transition destination has not been reached, this self-loop continues until `[C_one()]` is false.

Assume that after five iterations, `[C_one()]` is false.

- 5 The next possible transition segment (to the next connective junction) is evaluated. It is an unconditional transition segment with a condition action. The transition segment is taken and the condition action, `{d=my_func()}`, executes and completes. The returned value of `d` is 84.
- 6 The next possible transition segment is evaluated. Three outgoing transition segments exist: two conditional and one unconditional. Because implicit ordering applies, the segment labeled with the condition `[d < 100]` evaluates first based on the geometry of the two outgoing conditional transition segments. Because the returned value of `d` is 84, the condition `[d < 100]` is true and this transition to the destination state A.A1 is valid.
- 7 State A.A1 exit actions (`exitA1()`) execute and complete.
- 8 State A.A1 is marked inactive.
- 9 State A.A1 is marked active.
- 10 State A.A1 entry actions (`entA1()`) execute and complete.
- 11 The chart goes back to sleep.

This sequence completes the execution of this Stateflow chart associated with event `E_one`.

Transition from a Common Source to Multiple Destinations

This example shows the behavior of transitions from a common source to multiple conditional destinations using a connective junction. The chart uses implicit ordering of outgoing transitions (see “Implicit Ordering” on page 3-39).

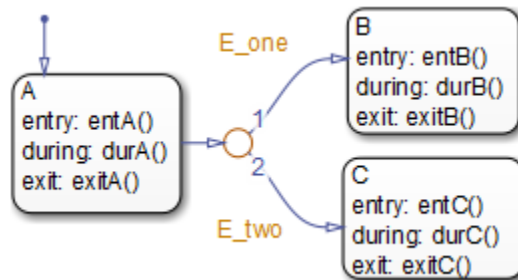

Initially, the chart is asleep. State A is active. Event E_two occurs and awakens the chart, which processes the event from the root down through the hierarchy:

- 1 The chart root checks to see if there is a valid transition as a result of E_two. A valid transition segment exists from state A to the connective junction. Because implicit ordering applies, evaluation of segments with equivalent label priority begins from a 12 o'clock position on the connective junction and progresses clockwise. The first transition segment, labeled with event E_one, is not valid. The next transition segment, labeled with event E_two, is valid. The complete transition from state A to state C is valid.
- 2 State A exit actions (exitA()) execute and complete.
- 3 State A is marked inactive.
- 4 State C is marked active.
- 5 State C entry actions (entC()) execute and complete.
- 6 The chart goes back to sleep.

This sequence completes the execution of this Stateflow chart associated with event E_two.

Resolve Equally Valid Transition Paths

What Are Conflicting Transitions?

Conflicting transitions are two equally valid paths from the same source in a Stateflow chart during simulation. In the case of a conflict, the chart evaluates equally valid transitions based on ordering mode in the chart: explicit or implicit.

- For explicit ordering (the default mode), evaluation of conflicting transitions occurs based on the order you specify for each transition. For details, see “Explicit Ordering” on page 3-39.
- For implicit ordering in C charts, evaluation of conflicting transitions occurs based on internal rules described in “Implicit Ordering” on page 3-39.

Example of Conflicting Transitions

The following chart has two equally valid transition paths:

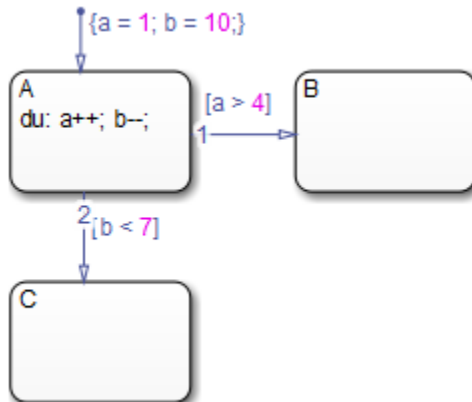

Conflict Resolution for Implicit Ordering

For implicit ordering, the chart evaluates multiple outgoing transitions with equal label priority in a clockwise progression starting from the twelve o'clock position on the state. In this case, the transition from state A to state B occurs.

Conflict Resolution for Explicit Ordering

For explicit ordering, the chart resolves the conflict by evaluating outgoing transitions in the order that you specify explicitly. For example, if you right-click the transition from state A to state C and select **Execution Order** > **1** from the context menu, the chart evaluates that transition first. In this case, the transition from state A to state C occurs.

How the Transition Conflict Occurs

The default transition to state A assigns data a equal to 1 and data b equal to 10. The during action of state A increments a and decrements b during each time step. The transition from state A to state B is valid if the condition [a > 4] is true. The transition from state A to state C is valid if the condition [b < 7] is true. During simulation, there is a time step where state A is active and both conditions are true. This issue is a transition conflict.

Transition from Multiple Sources to a Common Destination

This example shows the behavior of transitions from multiple sources to a single destination using a connective junction.

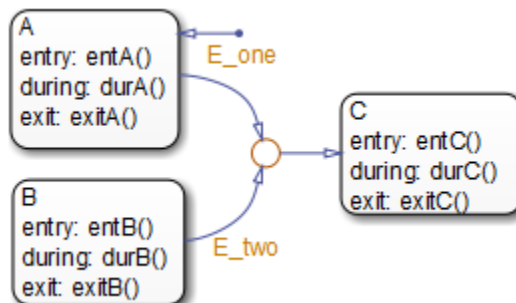

Initially, the chart is asleep. State A is active. Event E_one occurs and awakens the chart, which processes the event from the root down through the hierarchy:

- 1 The chart root checks to see if there is a valid transition as a result of `E_one`. A valid transition segment exists from state A to the connective junction and from the junction to state C.
- 2 State A exit actions (`exitA()`) execute and complete.
- 3 State A is marked inactive.
- 4 State C is marked active.
- 5 State C entry actions (`entC()`) execute and complete.
- 6 The chart goes back to sleep.

This sequence completes the execution of this Stateflow chart associated with event `E_one`.

Transition from a Source to a Destination Based on a Common Event

This example shows the behavior of transitions from multiple sources to a single destination based on the same event using a connective junction.

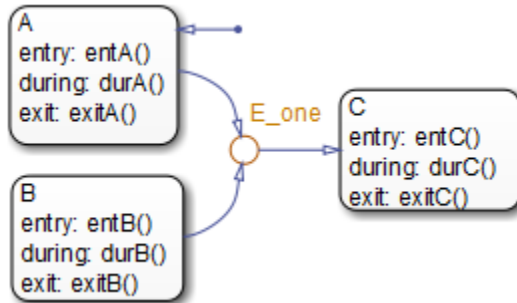

Initially, the chart is asleep. State B is active. Event `E_one` occurs and awakens the chart, which processes the event from the root down through the hierarchy:

- 1 The chart root checks to see if there is a valid transition as a result of `E_one`. A valid transition segment exists from state B to the connective junction and from the junction to state C.
- 2 State B exit actions (`exitB()`) execute and complete.
- 3 State B is marked inactive.
- 4 State C is marked active.
- 5 State C entry actions (`entC()`) execute and complete.
- 6 The chart goes back to sleep.

This sequence completes the execution of this Stateflow chart associated with event `E_one`.

Backtrack in Flow Charts

This example shows the behavior of transitions with junctions that force backtracking behavior in flow charts. The chart uses implicit ordering of outgoing transitions (see “Implicit Ordering” on page 3-39).

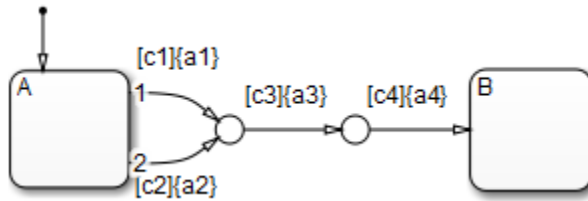

Initially, state A is active and conditions c1, c2, and c3 are true:

- 1 The chart root checks to see if there is a valid transition from state A.

There is a valid transition segment marked with the condition c1 from state A to a connective junction.

- 2 Condition c1 is true and action a1 executes.
- 3 Condition c3 is true and action a3 executes.
- 4 Condition c4 is not true and control flow backtracks to state A.
- 5 The chart root checks to see if there is another valid transition from state A.

There is a valid transition segment marked with the condition c2 from state A to a connective junction.

- 6 Condition c2 is true and action a2 executes.
- 7 Condition c3 is true and action a3 executes.
- 8 Condition c4 is not true and control flow backtracks to state A.
- 9 The chart goes to sleep.

The preceding example shows the unexpected behavior of executing both actions a1 and a2. Another unexpected behavior is the execution of action a3 twice. To resolve this problem, consider adding unconditional transitions to terminating junctions.

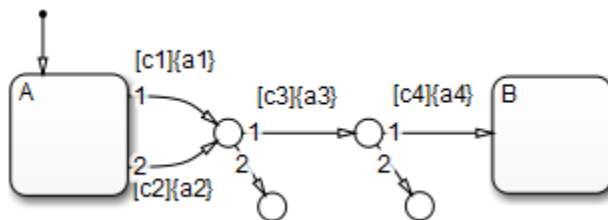

The terminating junctions allow flow to end if either c3 or c4 is not true. This design leaves state A active without executing unnecessary actions.

Control Chart Execution by Using Event Actions in a Superstate

The following example shows the use of event actions in a superstate.

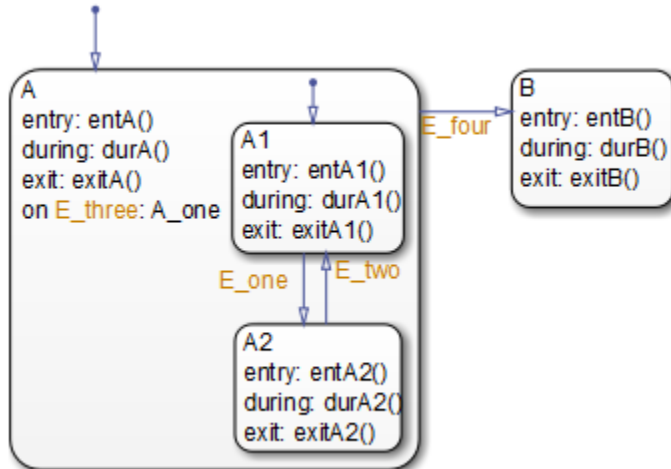

Initially, the chart is asleep. State A.A1 is active. Event E_three occurs and awakens the chart, which processes the event from the root down through the hierarchy:

- 1 The chart root checks to see if there is a valid transition as a result of E_three. No valid transition exists.
- 2 State A during actions (durA()) execute and complete.
- 3 State A executes and completes the on event E_three action (A_one).
- 4 State A checks its children for valid transitions. No valid transitions exist.
- 5 State A1 during actions (durA1()) execute and complete.
- 6 The chart goes back to sleep.

This sequence completes the execution of this Stateflow chart associated with event E_three.

Undirected Broadcast Events in Parallel States

Broadcast Events in State Actions

This example shows the behavior of event broadcast actions in parallel states. The chart uses implicit ordering of parallel states (see “Implicit Ordering of Parallel States” on page 3-59).

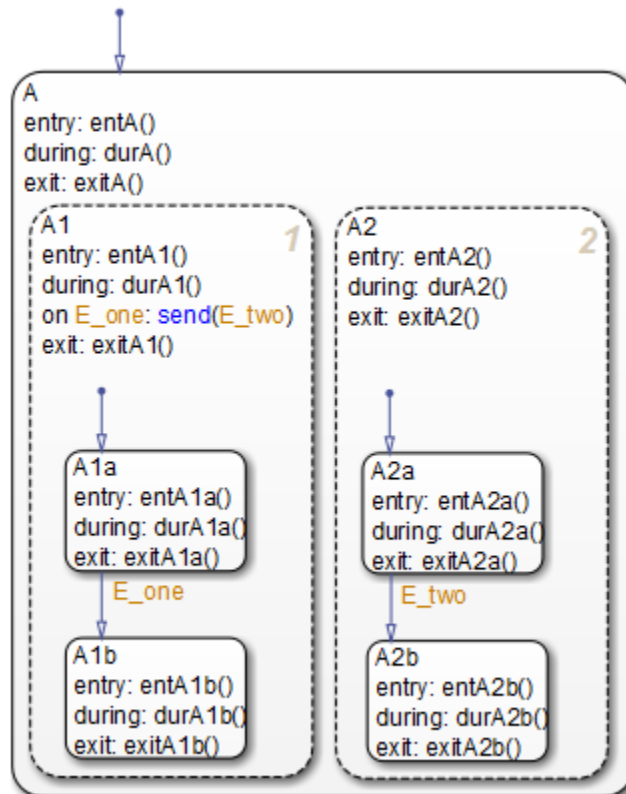

Initially, the chart is asleep. Parallel substates A.A1.A1a and A.A2.A2a are active. Event *E_one* occurs and awakens the chart, which processes the event from the root down through the hierarchy:

- 1 The chart root checks to see if there is a valid transition at the root level as a result of *E_one*. No valid transition exists.
- 2 State A during actions (*durA()*) execute and complete.
- 3 The children of state A are parallel (AND) states. Because implicit ordering applies, the states are evaluated and executed from left to right and top to bottom. State A.A1 is evaluated first. State A.A1 during actions (*durA1()*) execute and complete. State A.A1 executes and completes the on *E_one* action and broadcasts event *E_two*. The during and on *event_name* actions are processed based on their order of appearance in the state label:
 - a The broadcast of event *E_two* awakens the chart a second time. The chart root checks to see if there is a valid transition as a result of *E_two*. No valid transition exists.
 - b State A during actions (*durA()*) execute and complete.
 - c State A checks its children for valid transitions. No valid transitions exist.

- d** State A's children are evaluated starting with state A.A1. State A.A1 during actions (durA1()) execute and complete. State A.A1 is evaluated for valid transitions. There are no valid transitions as a result of E_two within state A1.
 - e** State A1a's during actions (durA1a()) execute.
 - f** State A.A2 is evaluated. State A.A2 during actions (durA2()) execute and complete. State A.A2 checks for valid transitions. State A.A2 has a valid transition as a result of E_two from state A.A2.A2a to state A.A2.A2b.
 - g** State A.A2.A2a exit actions (exitA2a()) execute and complete.
 - h** State A.A2.A2a is marked inactive.
 - i** State A.A2.A2b is marked active.
 - j** State A.A2.A2b entry actions (entA2b()) execute and complete.
- 4** The processing of E_one continues once the on event broadcast of E_two has been processed. State A.A1 checks for any valid transitions as a result of event E_one. A valid transition exists from state A.A1.A1a to state A.A1.A1b.
 - 5** State A.A1.A1a executes and completes exit actions (exitA1a).
 - 6** State A.A1.A1a is marked inactive.
 - 7** State A.A1.A1b is marked active.
 - 8** State A.A1.A1b entry actions (entA1b()) execute and complete.
 - 9** Parallel state A.A2 is evaluated next. State A.A2 during actions (durA2()) execute and complete. There are no valid transitions as a result of E_one.
 - 10** State A.A2.A2b during actions (durA2b()) execute and complete.

State A.A2.A2b is now active as a result of the processing of the on event broadcast of E_two.
 - 11** The chart goes back to sleep.

This sequence completes the execution of this Stateflow chart associated with event E_one and the on event broadcast to a parallel state of event E_two. The final chart activity is that parallel substates A.A1.A1b and A.A2.A2b are active.

Tip Avoid using undirected local event broadcasts. Undirected local event broadcasts can cause unwanted recursive behavior in your chart. Instead, send local events by using directed broadcasts. For more information, see “Broadcast Local Events to Synchronize Parallel States” on page 13-37.

You can set the diagnostic level for detecting undirected local event broadcasts. In the Configuration Parameters dialog box, open the **Diagnostics > Stateflow** pane and set the **Undirected event broadcasts** parameter to none, warning, or error. The default setting is warning.

Broadcast Events in Transition Actions

This example shows the behavior of an event broadcast transition action that includes a nested event broadcast in a parallel state. The chart uses implicit ordering of parallel states (see “Implicit Ordering of Parallel States” on page 3-59).

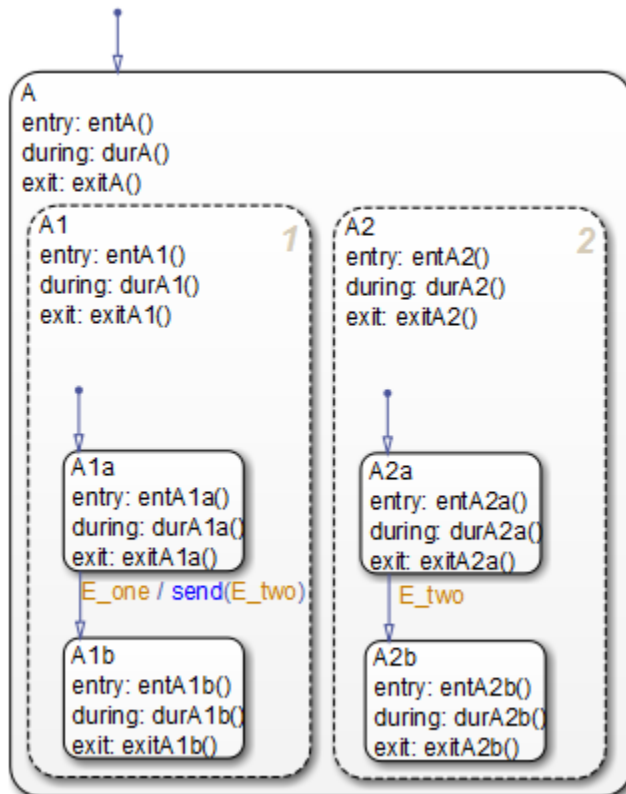

Start of Event E_one Processing

Initially, the chart is asleep. Parallel substates A.A1.A1a and A.A2.A2a are active. Event E_one occurs and awakens the chart, which processes the event from the root down through the hierarchy:

- 1 The chart root checks to see if there is a valid transition as a result of E_one. There is no valid transition.
- 2 State A during actions (durA()) execute and complete.
- 3 State A's children are parallel (AND) states. Because implicit ordering applies, the states are evaluated and executed from left to right and top to bottom. State A.A1 is evaluated first. State A.A1 during actions (durA1()) execute and complete.
- 4 State A.A1 checks for any valid transitions as a result of event E_one. There is a valid transition from state A.A1.A1a to state A.A1.A1b.
- 5 State A.A1.A1a executes and completes exit actions (exitA1a).
- 6 State A.A1.A1a is marked inactive.

Event E_two Preempts E_one

- 1 The transition action that broadcasts event E_two executes and completes:
 - a The broadcast of event E_two now preempts the transition from state A1a to state A1b that event E_one triggers.
 - b The broadcast of event E_two awakens the chart a second time. The chart root checks to see if there is a valid transition as a result of E_two. No valid transition exists.

- c** State A during actions (`durA()`) execute and complete.
- d** State A's children are evaluated starting with state A.A1. State A.A1 during actions (`durA1()`) execute and complete. State A.A1 is evaluated for valid transitions. There are no valid transitions as a result of `E_two` within state A1.
- e** State A.A2 is evaluated. State A.A2 during actions (`durA2()`) execute and complete. State A.A2 checks for valid transitions. State A.A2 has a valid transition as a result of `E_two` from state A.A2.A2a to state A.A2.A2b.
- f** State A.A2.A2a exit actions (`exitA2a()`) execute and complete.
- g** State A.A2.A2a is marked inactive.
- h** State A.A2.A2b is marked active.
- i** State A.A2.A2b entry actions (`entA2b()`) execute and complete.

Event `E_one` Processing Resumes

- 1** State A.A1.A1b is marked active.
- 2** State A.A1.A1b entry actions (`entA1b()`) execute and complete.
- 3** Parallel state A.A2 is evaluated next. State A.A2 during actions (`durA2()`) execute and complete. There are no valid transitions as a result of `E_one`.
- 4** State A.A2.A2b during actions (`durA2b()`) execute and complete.

State A.A2.A2b is now active as a result of the processing of event broadcast `E_two`.

- 5** The chart goes back to sleep.

This sequence completes the execution of this Stateflow chart associated with event `E_one` and the event broadcast on a transition action to a parallel state of event `E_two`. The final chart activity is that parallel substates A.A1.A1b and A.A2.A2b are active.

Tip Avoid using undirected local event broadcasts. Undirected local event broadcasts can cause unwanted recursive behavior in your chart. Instead, send local events by using directed broadcasts. For more information, see “Broadcast Local Events to Synchronize Parallel States” on page 13-37.

You can set the diagnostic level for detecting undirected local event broadcasts. In the Configuration Parameters dialog box, open the **Diagnostics > Stateflow** pane and set the **Undirected event broadcasts** parameter to none, warning, or error. The default setting is warning.

Broadcast Events in Condition Actions

This example shows the behavior of a condition action event broadcast in a parallel (AND) state. The chart uses implicit ordering of parallel states (see “Implicit Ordering of Parallel States” on page 3-59).

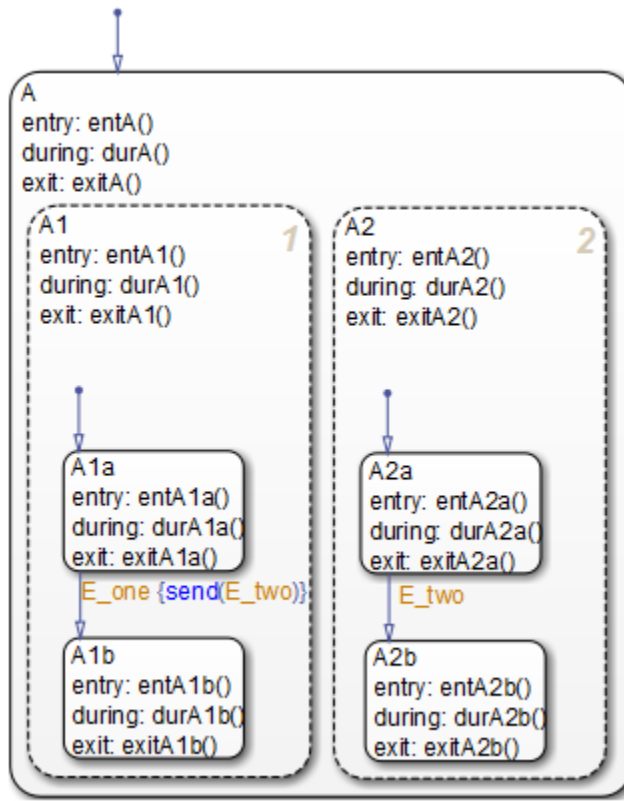

Initially, the chart is asleep. Parallel substates A.A1.A1a and A.A2.A2a are active. Event E_one occurs and awakens the chart, which processes the event from the root down through the hierarchy:

- 1 The chart root checks to see if there is a valid transition as a result of E_one. No valid transition exists.
- 2 State A during actions (durA()) execute and complete.
- 3 State A's children are parallel (AND) states. Because implicit ordering applies, the states are evaluated and executed from top to bottom, and from left to right. State A.A1 is evaluated first. State A.A1 during actions (durA1()) execute and complete.
- 4 State A.A1 checks for any valid transitions as a result of event E_one. A valid transition from state A.A1.A1a to state A.A1.A1b exists. A valid condition action also exists. The condition action event broadcast of E_two executes and completes. State A.A1.A1a is still active:
 - a The broadcast of event E_two awakens the Stateflow chart a second time. The chart root checks to see if there is a valid transition as a result of E_two. There is no valid transition.
 - b State A during actions (durA()) execute and complete.
 - c State A's children are evaluated starting with state A.A1. State A.A1 during actions (durA1()) execute and complete. State A.A1 is evaluated for valid transitions. There are no valid transitions as a result of E_two within state A1.
 - d State A1a during actions (durA1a()) execute.
 - e State A.A2 is evaluated. State A.A2 during actions (durA2()) execute and complete. State A.A2 checks for valid transitions. State A.A2 has a valid transition as a result of E_two from state A.A2.A2a to state A.A2.A2b.

- f** State A.A2.A2a exit actions (`exitA2a()`) execute and complete.
- g** State A.A2.A2a is marked inactive.
- h** State A.A2.A2b is marked active.
- i** State A.A2.A2b entry actions (`entA2b()`) execute and complete.
- 5** State A.A1.A1a executes and completes exit actions (`exitA1a`).
- 6** State A.A1.A1a is marked inactive.
- 7** State A.A1.A1b is marked active.
- 8** State A.A1.A1b entry actions (`entA1b()`) execute and complete.
- 9** Parallel state A.A2 is evaluated next. State A.A2 during actions (`durA2()`) execute and complete. There are no valid transitions as a result of E_one.
- 10** State A.A2.A2b during actions (`durA2b()`) execute and complete.

State A.A2.A2b is now active as a result of the processing of the condition action event broadcast of E_two.
- 11** The chart goes back to sleep.

This sequence completes the execution of this Stateflow chart associated with event E_one and the event broadcast on a condition action to a parallel state of event E_two. The final chart activity is that parallel substates A.A1.A1b and A.A2.A2b are active.

Tip Avoid using undirected local event broadcasts. Undirected local event broadcasts can cause unwanted recursive behavior in your chart. Instead, send local events by using directed broadcasts. For more information, see “Broadcast Local Events to Synchronize Parallel States” on page 13-37.

You can set the diagnostic level for detecting undirected local event broadcasts. In the Configuration Parameters dialog box, open the **Diagnostics > Stateflow** pane and set the **Undirected event broadcasts** parameter to none, warning, or error. The default setting is warning.

Broadcast Local Events in Parallel States

Directed Event Broadcast Using Send

This example shows the behavior of directed event broadcast using the `send(event_name, state_name)` syntax on a transition. The chart uses implicit ordering of parallel states (see “Implicit Ordering of Parallel States” on page 3-59).

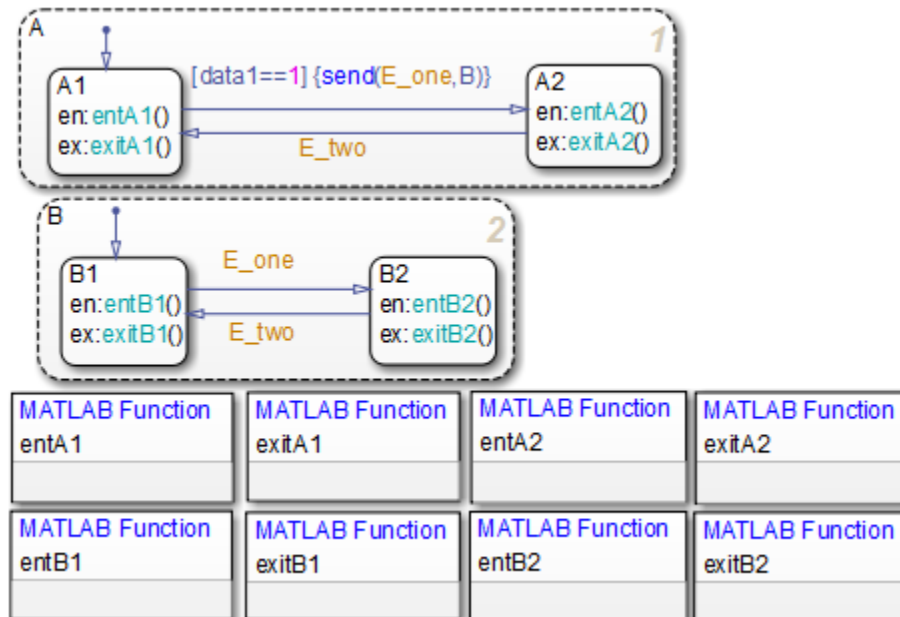

Initially, the chart is asleep. Parallel substates A.A1 and B.B1 are active, which implies that parallel (AND) superstates A and B are also active. The condition `[data1==1]` is true. The event `E_one` belongs to the chart and is visible to both A and B.

After waking up, the chart checks for valid transitions at every level of the hierarchy:

- 1 The chart root checks to see if there is a valid transition as a result of the event. There is no valid transition.
- 2 State A checks for any valid transitions as a result of the event. Because the condition `[data1==1]` is true, there is a valid transition from state A.A1 to state A.A2.
- 3 The action `send(E_one, B)` executes:
 - a The broadcast of event `E_one` reaches state B. Because state B is active, that state receives the event broadcast and checks to see if there is a valid transition. There is a valid transition from B.B1 to B.B2.
 - b State B.B1 exit actions (`exitB1()`) execute and complete.
 - c State B.B1 becomes inactive.
 - d State B.B2 becomes active.
 - e State B.B2 entry actions (`entB2()`) execute and complete.
- 4 State A.A1 exit actions (`exitA1()`) execute and complete.

- 5 State A.A1 becomes inactive.
- 6 State A.A2 becomes active.
- 7 State A.A2 entry actions (entA2()) execute and complete.

This sequence completes execution of a chart with a directed event broadcast to a parallel state.

Directed Event Broadcast Using Qualified Event Name

This example shows the behavior of directed event broadcast using a qualified event name on a transition. The chart uses implicit ordering of parallel states (see “Implicit Ordering of Parallel States” on page 3-59).

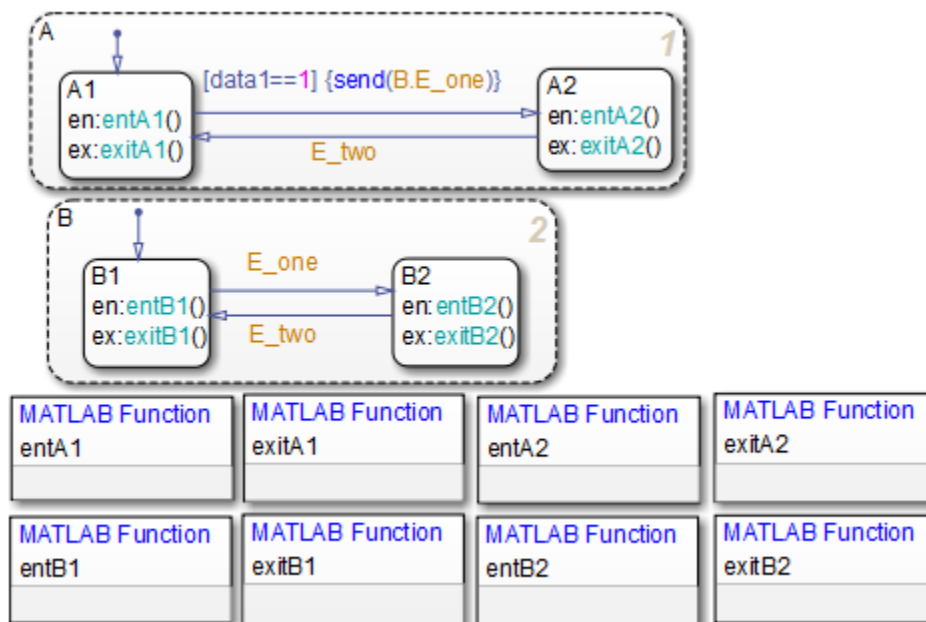

The only differences from the chart in “Directed Event Broadcast Using Send” on page B-39 are:

- The event E_one belongs to state B and is visible only to that state.
- The action send(E_one, B) is now send(B.E_one).

Using a qualified event name is necessary because E_one is not visible to state A.

After waking up, the chart checks for valid transitions at every level of the hierarchy:

- 1 The chart root checks to see if there is a valid transition as a result of the event. There is no valid transition.
- 2 State A checks for any valid transitions as a result of the event. Because the condition [data1==1] is true, there is a valid transition from state A.A1 to state A.A2.
- 3 The action send(B.E_one) executes and completes:
 - a The broadcast of event E_one reaches state B. Because state B is active, that state receives the event broadcast and checks to see if there is a valid transition. There is a valid transition from B.B1 to B.B2.

- b** State B.B1 exit actions (`exitB1()`) execute and complete.
- c** State B.B1 becomes inactive.
- d** State B.B2 becomes active.
- e** State B.B2 entry actions (`entB2()`) execute and complete.
- 4** State A.A1 exit actions (`exitA1()`) execute and complete.
- 5** State A.A1 becomes inactive.
- 6** State A.A2 becomes active.
- 7** State A.A2 entry actions (`entA2()`) execute and complete.

This sequence completes execution of a chart with a directed event broadcast using a qualified event name to a parallel state.

See Also

send

More About

- “Broadcast Local Events to Synchronize Parallel States” on page 13-37

Glossary

actions	<p><i>Actions</i> take place as part of Stateflow chart execution. The action can execute as part of a transition from one state to another, or depending on the activity status of a state. Transitions can contain condition actions and transition actions.</p> <p><i>Action language</i> defines the categories of actions you can specify and their associated notations. For example, states can have <i>entry</i>, <i>during</i>, <i>exit</i>, and <i>on event_name</i> actions.</p>
API (application programming interface)	Format you can use to access and communicate with an application program from a programming or script environment.
atomic box	Graphical object that enables you to reuse functions across multiple charts. For more information, see “When to Use Atomic Boxes” on page 8-31.
atomic subchart	Graphical object that enables you to reuse states and subcharts across multiple charts. For more information, see “When to Use Atomic Subcharts” on page 16-4.
box	Graphical object that groups together other graphical objects in your chart. For details about how a box affects chart execution, see “Group Chart Objects by Using Boxes” on page 8-22.
chart instance	Link from a model to a chart stored in a Simulink library. A chart in a library can have many chart instances. Updating the chart in the library automatically updates all instances of that chart.
condition	Boolean expression to specify that a transition occurs when the specified expression is true.
connective junction	<p>Illustrates decision points in the system. A connective junction is a graphical object that simplifies Stateflow chart representations and facilitates generation of efficient code. Connective junctions provide different ways to represent desired system behavior.</p> <p>See “Combine Transitions and Junctions to Create Branching Paths” on page 2-31 for more information.</p>
data	<i>Data</i> objects store numerical values for reference in the Stateflow chart.
decomposition	<p>A state has a <i>decomposition</i> when it consists of one or more substates. A chart that contains at least one state also has decomposition. Rules govern how you can group states in the hierarchy. A superstate has either parallel (AND) or exclusive (OR) decomposition. All substates at a particular level in the hierarchy must have the same decomposition.</p> <ul style="list-style-type: none">• Parallel (AND) State Decomposition <p><i>Parallel (AND) state decomposition</i> applies when states have dashed borders. This decomposition describes states at that same</p>

	<p>level in the hierarchy that can be active at the same time. The activity within parallel states is essentially independent.</p> <ul style="list-style-type: none">• Exclusive (OR) State Decomposition <p><i>Exclusive (OR) state decomposition</i> applies when states have solid borders. This decomposition describes states that are mutually exclusive. Only one state at the same level in the hierarchy can be active at a time.</p>
default transition	<p>Primarily used to specify which exclusive (OR) state is to be entered when there is ambiguity among two or more neighboring exclusive (OR) states. For example, default transitions specify which substate of a superstate with exclusive (OR) decomposition the system enters by default in the absence of any other information. Default transitions can also specify that a junction should be entered by default. The default transition object is a transition with a destination but no source object.</p> <p>See “Default Transitions” on page 2-28 for more information.</p>
events	<p><i>Events</i> drive chart execution. All events that affect the chart must be defined. The occurrence of an event causes the status of states in a chart to be evaluated. The broadcast of an event can trigger a transition to occur or an action to execute. Events are broadcast in a top-down manner starting from the event's parent in the hierarchy.</p>
Finder	<p>Tool to search for objects in Stateflow charts on platforms that do not support the Simulink Find tool.</p>
finite state machine (FSM)	<p>Representation of an event-driven system. FSMs are also used to describe reactive systems. In an event-driven or reactive system, the system transitions from one mode or state to another prescribed mode or state, provided that the condition defining the change is true.</p>
flow chart	<p>Set of decision flow paths that start from a transition segment that, in turn, starts from a state or a default transition segment.</p>
flow path	<p>Ordered sequence of transition segments and junctions where each succeeding segment starts on the junction that terminated the previous segment.</p>
flow subgraph	<p>Set of decision flow paths that start on the same transition segment.</p>
graphical function	<p>A chart function whose logic is defined by a flow chart. See “Reuse Logic Patterns by Defining Graphical Functions” on page 8-13.</p>
hierarchy	<p><i>Hierarchy</i> enables you to organize complex systems by placing states within other higher-level states. A hierarchical design usually reduces the number of transitions and produces neat, more manageable charts. See “Overview of Stateflow Objects” on page 2-2 for more information.</p>
history junction	<p>Specifies the destination substate of a transition based on historical information. If a superstate has a history junction, the transition to the</p>

destination substate is the substate that was most recently active. The history junction applies only to the level of the hierarchy in which it appears.

See the following sections for more information:

- “History Junctions” on page 2-36
- “Default Transition and a History Junction” on page B-15
- “Labeled Default Transitions” on page B-16
- “Inner Transition to a History Junction” on page B-21

inner transitions

Transition that does not exit the source state. Inner transitions are useful when defined for superstates with exclusive (OR) decomposition. Use of inner transitions can greatly simplify chart layout.

See “Inner Transitions” on page 2-25 and “Inner Transition to a History Junction” on page B-21 for more information.

library link

Link to a chart that is stored in a library model.

library model

Stateflow model that is stored in a Simulink library. You can include charts from a library in your model by copying them. When you copy a chart from a library into your model, you create only a link to the library chart. You can create multiple links to a single chart. Each link is called a *chart instance*. When you include a chart from a library in your model, you also include its Stateflow machine. Therefore, a Stateflow model that includes links to library charts has multiple Stateflow machines.

When you simulate a model that includes charts from a library model, you include all charts from the library model even if links exist only for some of its models. You can simulate a model that includes links to a library model only when all charts in the library model are free of parse and compile errors.

machine

Collection of all Stateflow blocks defined by a Simulink model. This collection excludes chart instances from library links. If a model includes any library links, it also includes the Stateflow machines defined by the models from which the links originate.

MATLAB function

A chart function that works with a subset of the MATLAB programming language.

Mealy machine

An industry-standard paradigm for modeling finite-state machines, where output is a function of both inputs *and* state.

Model Explorer

Use to add, remove, and modify data, event, and target objects in the Stateflow hierarchy. See “Use the Model Explorer with Stateflow Objects” on page 34-10 for more information.

Moore machine

An industry-standard paradigm for modeling finite-state machines, where output is a function *only* of state.

notation	<p>Defines a set of objects and the rules that govern the relationships between those objects. Stateflow chart notation provides a way to communicate the design information in a Stateflow chart.</p> <p>Stateflow chart notation includes:</p> <ul style="list-style-type: none">• A set of graphical objects• A set of nongraphical text-based objects• Defined relationships between those objects
parallelism	<p>A system with <i>parallelism</i> can have two or more states that can be active at the same time. The activity of parallel states is essentially independent. Parallelism is represented with a parallel (AND) state decomposition.</p> <p>See “State Decomposition” on page 2-9 for more information.</p>
S-function	<p>When you simulate a Simulink model containing Stateflow charts, you generate an <i>S-function</i> (MEX-file) for each Stateflow machine. This generated code is a simulation target.</p>
semantics	<p><i>Semantics</i> describe how the notation is interpreted and implemented behind the scenes. A completed Stateflow chart communicates how the system will behave. A chart contains actions associated with transitions and states. The semantics describe in what sequence these actions take place during chart execution.</p>
Simulink function	<p>A chart function that you fill with Simulink blocks and call in the actions of states and transitions. This function provides an efficient model design and improves readability by minimizing the graphical and nongraphical objects required in a model. In a Stateflow chart, this function acts like a function-call subsystem block of a Simulink model.</p>
state	<p>A <i>state</i> describes a mode of a reactive system. A reactive system has many possible states. States in a chart represent these modes. The activity or inactivity of the states dynamically changes based on transitions among events and conditions.</p> <p>Every state has hierarchy. In a chart consisting of a single state, the parent of that state is the Stateflow chart itself. A state also has history that applies to its level of hierarchy in the chart. States can have actions that execute in a sequence based upon action type. The action types are entry, during, exit, or on event_name actions.</p>
Stateflow block	<p>Masked Simulink model that is equivalent to an empty, untitled Stateflow chart. Use the Stateflow block to include a chart in a Simulink model.</p> <p>The control behavior modeled by a Stateflow block complements the algorithmic behavior modeled in Simulink block diagrams. By incorporating Stateflow blocks into Simulink models, you can add complex event-driven behavior to Simulink simulations. You create</p>

models that represent both data and decision flow by combining Stateflow blocks with the standard Simulink and toolbox block libraries.

Stateflow chart	A Stateflow chart is a graphical representation of a finite state machine where <i>states</i> and <i>transitions</i> form the basic building blocks of the system.
Stateflow Finder	Use to display a list of objects based on search criteria you specify. You can directly access the properties dialog box of any object in the search output display by clicking that object.
subchart	Chart contained by another chart. See “Encapsulate Modal Logic by Using Subcharts” on page 8-4.
substate	A state is a <i>substate</i> if it is contained by a superstate.
superstate	A state is a <i>superstate</i> if it contains other states, called substates.
supertransition	Transition between objects residing in different subcharts. See “Move Between Levels of Hierarchy by Using Supertransitions” on page 8-7 for more information.
target	<p>A container object for the generated code from the Stateflow charts in a model. The collection of all charts for a model appears as a Stateflow machine. Therefore, target objects belong to the Stateflow machine.</p> <p>The code generation process can produce these target types: simulation, embeddable, and custom.</p>
transition	The circumstances under which the system moves from one state to another. Either end of a transition can be attached to a source and a destination object. The <i>source</i> is where the transition begins and the <i>destination</i> is where the transition ends. Usually, the occurrence of an event causes a transition to take place.
transition path	Flow path that starts and ends on a state.
transition segment	A state-to-junction, junction-to-junction, or junction-to-state part of a complete state-to-state transition.
truth table function	A chart function that specifies logical behavior with conditions, decisions, and actions. Truth tables are easier to program and maintain than graphical functions.

